

Lieferprogramm

2025

 **AGROB BUCHTAL**

Solid Ground

Die Serie Solid Ground, entworfen mit Hadi Teherani, kombiniert Beton und Travertin zu einem eleganten Design. Mit modernen Farben, modularen Formaten und 145 cm langen Treppenfliesen bietet sie kreative Möglichkeiten für Wohn- und Gewerberäume – ideal für Architekten, Planer und Bauherren. Weitere Informationen auf den Seiten 412 - 423.



Ocean

Ocean bietet eine faszinierende Farbpalette für Pool, Spa und Wellness. Inspiriert von Wasser und Natur, verbinden changierende Blau-, Grün- und Sandtöne Lebendigkeit mit Eleganz. Perfekt für atmosphärische Designs, ergänzt durch vielseitige Formate und Kombinierbarkeit mit anderen Serien. Weitere Informationen auf den Seiten 316 - 321.

Streetlife Metallic

Die Serie Streetlife Metallic kombiniert urbane Coolness mit dem Charme gelebter Oberflächen und erinnert an gebürstetes Metall mit Rost- und Oxidationsspuren. Die kraftvolle Ästhetik und metallischen Farben schaffen ein zeitloses, urbanes Flair, ideal für moderne Wohnkonzepte, Lofts und öffentliche Räume. Die Fliesen sind in vielseitigen Formaten und robuster Stärke erhältlich, perfekt für private und gewerbliche Anwendungen. Weitere Informationen auf den Seiten 468 - 471.



Einleitung	4 – 25
Produktfinder	26 – 35

Serien A–Z

Alcina	38 – 45
Amano	46 – 49
Area Pro	50 – 77
Aruba	78 – 85
Ascona	86 – 99
Basic Stone	100 – 103
Basis	104 – 113
Basis 1	107 – 108
Basis 1+	109
Basis 2	110
Basis 3	111 – 112
Basis 4	113
Basis Pro	114 – 121
Blindenleitsysteme	122 – 127
Bliss	128 – 131
Cedra	132 – 139
Chroma	140 – 149
Chroma non-slip	150 – 159
Chroma unglasiert	160 – 167
Concrete	168 – 171
Craft	172 – 177
Craft Extended	178 – 181
District	182 – 185
Eladuct + Keraion ELA	186 – 189
Emotion	190 – 195
Emotion Grip	196 – 201
Evalia	202 – 207
Factory	208 – 217
Ferrum	218 – 221
Fresh	222 – 235
Karl	236 – 241
Keraion-OP-Spezialglasuren	242 – 245
Like	246 – 255
Loop	256 – 263
Lounge	264 – 273
Mandalay	274 – 277
Mando	278 – 283
Marble & More	284 – 287
Naturkeramik	288 – 291
New Market	292 – 299
Nivella	300 – 301
Nova	302 – 309
Oak	310 – 315

NEU	Ocean	316 – 321
	Pattern	322 – 333
	Pizarro	334 – 337
	Plural	338 – 357
	Plural non-slip	358 – 365
	Plural unglasiert	366 – 371
	Quarzit	372 – 379
	Savona	380 – 385
	Senja Pure	386 – 391
	Sento	392 – 399
	Sierra	400 – 405
	Skill	406 – 411
NEU	Solid Ground	412 – 423
	Solid Rock	424 – 431
NEU	Stone Concept	432 – 437
NEU	Stone Duo	438 – 445
	Stories	446 – 455
NEU	Strata	456 – 467
NEU	Streetlife Metallic	468 – 471
	Trio	472 – 481
	Unique	482 – 487
	Valley	488 – 493
	Walden	494 – 497

Index/Technische Informationen

Artikelnummern	500 – 510
Formate	511 – 512
Formatnummern	513
Zuordnung NCS/RAL	514 – 515
Hellbezugswerte	
Leuchtdichtekontrast	516 – 519
Technische Informationen	520 – 539
Vertriebskontakte D-A-CH	542 – 543
Erläuterungen	546 – 547

Wir verstehen. Seit 1755.



Verlässlich

Wir kennen uns aus mit Fliesen. Seit 1755 arbeiten wir mit Ton und haben ein umfassendes Verständnis für unser Material und für die Herstellung von Steinzeug, Feinsteinzeug und Steingut von höchster Qualität. In unseren vier deutschen Produktionsstätten verfeinern wir ständig unsere Rezepte zum Mischen von Ton, Feldspat, Schamotte, Kaolin und Wasser. Als natürliches Material, das in sorgfältig überwachten Brennprozessen von plastisch nach fest übergeht, bietet Ton unendliche Möglichkeiten der Herstellung von keramischen Produkten, die dazu beitragen, Architektur dauerhaft, nachhaltig und schön zu machen.



Vielseitig

Unsere Produkte finden weit und breit Anwendung. Innen und Außen. Von Privatwohnungen bis hin zu Museen. Von Hotels bis zu Krankenhäusern. Von Restaurants bis zu Büros. Von Geschäften bis zu Schwimmbädern. Von Badezimmerböden bis zu Gebäudefassaden. Wir bieten Boden-, Wand- und Fassadenfliesen für jeden Verwendungszweck an. Und wir stellen alle Arten von Spezialelementen her, um nahezu jede spezifische Anforderung zu erfüllen, sei es ein Formteil für ein Schwimmbad oder ein integriertes Leitsystem für sehbehinderte Menschen. Unsere Fliesen finden sich überall, weltweit.

Kooperativ

Ganz gleich, wie gut unsere Produkte sind, wir glauben, dass nur ihre Anwendung ihre Qualitäten zur Geltung bringt. Deshalb schätzen wir Zusammenarbeit und freuen uns, unser Wissen zu teilen, um die beste Lösung für jedes Ihrer Architekturprojekte zu finden. Dort wo unsere Standardprodukte an ihre Grenzen gelangen, entwickeln wir maßgeschneiderte Lösungen. Sonderfertigungen sind unsere Spezialität. Wir haben die Expertise und die Erfahrung, um Architekten von der Ausschreibung bis zur Fertigstellung von Projekten zu unterstützen. Sagen Sie uns, wie wir Ihnen helfen können. Sagen Sie uns, wenn Sie hören möchten, was wir wissen.

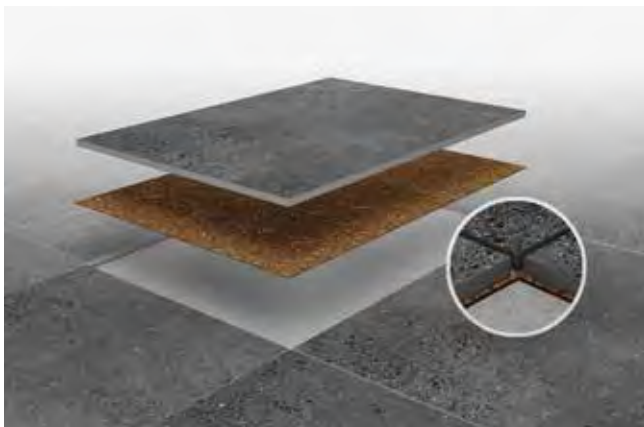
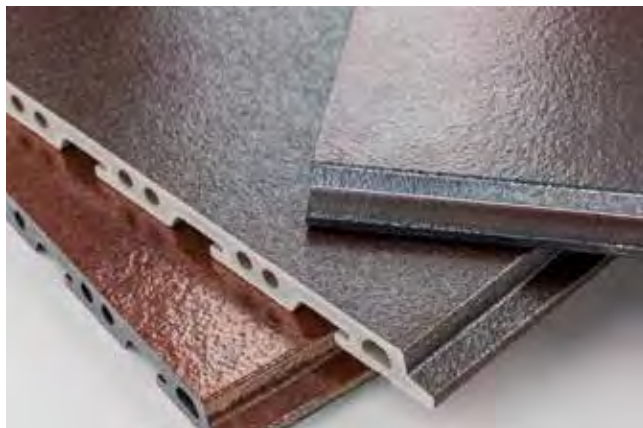

Innovativ

Wir wissen, wie man großartige Fliesen herstellt. Dennoch arbeiten wir ununterbrochen daran, sie noch besser zu machen. Handwerkliches Können und neue Technologien verbinden sich bei der Schaffung innovativer rutschhemmender Oberflächen für Nassbereiche und der Entwicklung neuer und einfacher Verfahren zur Verarbeitung von Keramik, wie z. B. Drytile, das eine Verlegung ohne Kleber ermöglicht. Wir investieren in Gesundheit und Hygiene, wie unsere nachhaltige Hytect-Technologie zeigt, die in fast jedem von uns hergestellten Produkt Anwendung findet. Neben der Entwicklung von Innovationen in allen Bereichen sind wir stolz darauf, maßgeschneiderte neue Lösungen anzubieten und Architekten bei der Umsetzung ihrer besten Ideen zu unterstützen.

Nachhaltig

Die Anforderungen an das Bauen wachsen kontinuierlich. Bauherren, Planer und Nutzer stellen neue Ansprüche, die auch die zukünftigen Entwicklungen stärker berücksichtigen. Energieeffizienz, Ressourcenschonung und Klimawandel sind hier die Stichworte, die entscheidenden Einfluss nehmen. Agrob Buchtal ist sich der Verantwortung zu nachhaltigem Bauen bewusst und unterstützt nachhaltiges Bauen nicht nur ideell über die Mitgliedschaft in der Deutschen Gesellschaft für Nachhaltiges Bauen (DGNB). Früh haben wir uns im Rahmen einer Umweltproduktdeklaration nach ISO14025 auf Branchenebene dazu entschlossen, alle für den Planungsprozess eines nachhaltigen Gebäudes wichtigen ökologischen Produktdaten transparent zu machen. Ob ein Gebäude unter Nachhaltigkeitsaspekten zu überzeugen vermag, lässt sich über Zertifizierungssysteme messbar machen. Hierzu müssen spezifische Produktinformationen zur Verfügung stehen und dokumentiert werden.



Wir sind vor Ort.

In Deutschland produziert und weltweit verfügbar.

DSA Deutsche Steinzeug America, Inc





Bremerhaven

Alfter-Witterschlick

Ötzingen

Sinzig

Schwarzenfeld

Deutsche Steinzeug Schweiz AG

Deutsche Steinzeug France S.A.R.L.

Modulare Farbsysteme

Modulare Farbsysteme sind für komplexe Anforderungen in allen Bereichen der Architekturkeramik konzipiert. Die Serie Area Pro ist mit ihrer umfangreichen Produktpalette an Fliesen und Zubehör ein echter Allrounder. Sie verbindet anspruchsvolles Design mit hoher Funktionalität und bietet so durchdachte Lösungen für die unterschiedlichsten Anwendungsbereiche. Als perfekte Synthese von Funktion und Ästhetik unterstützt Emotion durchgängige Raumkonzepte für funktionale und repräsentative Bereiche. Chroma und Plural fördern mit 50 aufeinander abgestimmten Farbtönen und einer Vielzahl an Formaten die variationsreiche, raumübergreifende Gestaltung von Wand- und Bodenflächen. Fresh und Loop bieten besonders spannende Farben und Formate im Bereich Mosaik.



Area Pro: Natürlich intuitiv

Gutes Design vermittelt immer einen intuitiven Zugang zu dessen Nutzung – so geht auch das Gestalten mit Area Pro leicht von der Hand. Die breite Produktpalette regt mit Erdtönen und einer angenehmen Haptik unmittelbar zu Ideen für ihren Einsatz an. Die von feinkörnigem, geschichtetem Kalkstein inspirierte Serie fügt sich mühelos ein und hebt sich zugleich ab. Das macht die Fliesen und ihr Zubehör zu perfekten Allroundern in fast jedem Ambiente. Die Serie strahlt bereits jetzt das Potenzial aus, ein Klassiker zu werden.

Chroma: Das Farbkonzept: Mischen und kombinieren

Wenn es um Farbgestaltung im Poolbereich geht, ist meist Blau die Farbe der Wahl. Chroma bietet darüber hinaus aber auch warme und neutrale Farbtöne aus dem von der Natur inspirierten Farbsystem – für variationsreiche Klassiker, individuelle Akzente und ganzheitliche Optik.

Die Farbskalen sind in sechs Gruppen unterteilt: Warme, erdige, kühle, frische und sonnige Farbtöne bewegen sich um eine Gruppe aus gedämpften, neutralen Grautönen. Jede Gruppe enthält Farben, die sich leicht kombinieren lassen, sowohl innerhalb der Gruppe als auch mit anderen Gruppen. So kann stets eine konsistente und einheitliche Gestaltung geschaffen werden.



Plural: Farbenfroh und flexibel

Die speziell für Plural entwickelte Farbpalette umfasst 50 aufeinander abgestimmte Farben. Ob glasiert oder unglasiert, Steingut, Steinzeug oder Feinsteinzeug – die schmale 3 mm-Fuge ist bei Plural ebenso Standard wie die schadstoffabbauende Veredelung Hytect und die Ausführung in verschiedenen Trittsicherheiten. Plural ist so vielseitig im Innen- und Außenbereich einsetzbar: von der Fassade bis zum Boden, von der U-Bahnstation bis zur Wellnesslandschaft.





Emotion: Modular und zeitlos

Mit aufeinander abgestimmten Farben und Oberflächen, rutschhemmenden Fliesen von R9 bis R12V4 und Formaten von 30 x 30 bis 60 x 60 cm bieten die Fliesen der Serie Emotion Architekten viel Freiraum. Emotion sorgt vor allem dort für eine gute Gestaltung, wo es um den Übergang zwischen Bereichen mit unterschiedlichen Anforderungen an die Rutschhemmung geht. Front cooking im Blickkontakt zu den Restaurantgästen wird dadurch ebenso möglich wie das reibungslose und ästhetisch gelungene Nebeneinander von Werkstatt und Showroom in einem Autohaus.

Fresh: Frisch und modern

Fresh bietet eine stimmige Palette an modernen, frischen Farben in den beliebten Mosaikformaten 2,5 x 2,5 cm und 5 x 5 cm, mit denen individuelle, aber zugleich auch unkompliziert zu realisierende Gestaltungen möglich werden. Besonders praktisch ist dabei: Zu den Fliesen gibt es farblich passende rutschhemmende Mosaik in R10/B und R11/C.

Farbverläufe akzentuieren ausgewählte Bereiche, lockern Gesamtbilder auf und inszenieren kunstvolle Wechselspiele mit homogenen Fliesenflächen. Als Verkleidung einzelner Elemente wie Säulen, Trennwände oder Bartheken bringen sie einen eigenen Rhythmus in den Raum.



Loop: Fein und rund

Das Geheimnis der Tiefe, Leuchtkraft und Beständigkeit der Farben ist die Glasur. Bis zu zehn Schichten werden auf das Steinzeug aufgetragen und abriebsicher eingebrannt. Die Glasuren erarbeiten wir selbst – mit ausgesuchten Rohstoffen. So entstehen Mosaik von strahlender, dauerhafter Schönheit.

Loop bietet ein breites Spektrum an intensiven und gedeckten Farbabstufungen im Blau- und Grünbereich, kräftige Gelb-, Orange- und Rotvarianten, Grau- und Braunnuancen bis hin zu Tiefschwarz. Zarte Transparenz für Leichtigkeit und Zeitlosigkeit, leuchtende Satttheit für Akzent und Ausdruck.

Innovativ.

Hytect – Die Luft ist rein

Die Hytect-Technologie wird bei hohen Temperaturen sicher in die Oberfläche der Keramik eingebrannt. Fällt Licht auf die so veredelten Fliesen, wird durch Photokatalyse Aktiv-sauerstoff freigesetzt. So entsteht die Wirkung gegen Bakterien und Schimmel. Gleichzeitig neutralisieren Hytect-Fliesen auf natürliche Weise Luftschadstoffe.

Und weil sie außerdem hydrophil sind, haften Schmutz und Fett kaum an ihnen. All diese Effekte wirken unvermindert über die gesamte Nutzungsdauer der Fliesen. Und Dank einer großen Bandbreite an Produkten ist Hytect-Keramik in verschiedensten Bereichen einsetzbar. Unsere Produkte, die mit unserer Hytect-Technologie veredelt sind, sind mit dem Hytect-Logo gekennzeichnet.

Die Wirkweisen

Extrem
reinigungsfreundlich

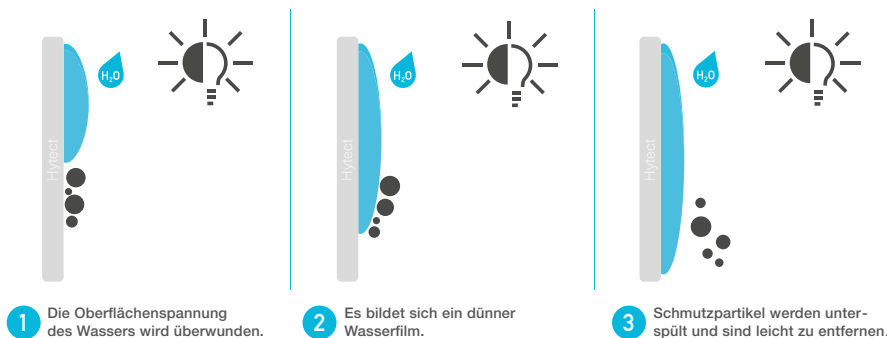

Effektiv gegen
Schimmel & Bakterien

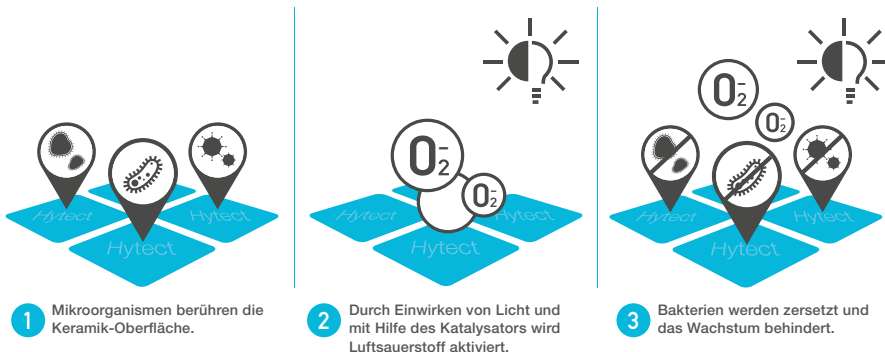

Aktiver Abbau von
Luftschadstoffen

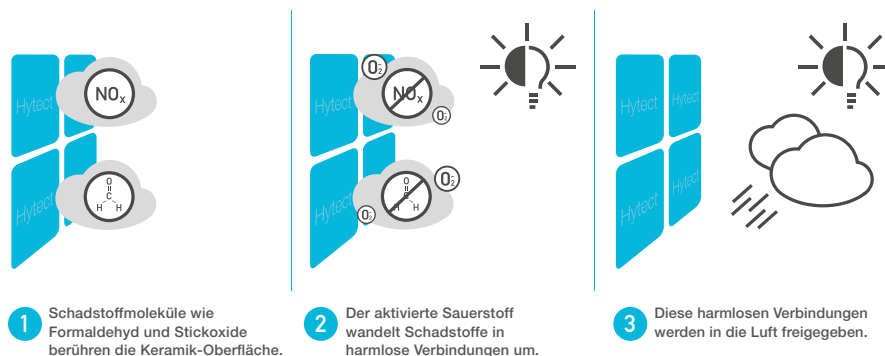

Zum Hytect-Film:



Weitere Informationen:
www.hytect.com



Rutschhemmende Fliesen für alle Einsatzbereiche

Stürze durch Ausrutschen, Stolpern/Umknicken oder Fehltreten sind in den meisten Betrieben und Einrichtungen Unfallschwerpunkt Nr. 1. Rutschhemmende Fliesen, markiert durch das Gütesiegel „GRIP“, zählen zu unseren Kernkompetenzen. Seit der Markteinführung der ersten rutschhemmenden Fliesen in den 1930er Jahren wurde diese Innovation von uns durch intensive Forschung ständig weiterentwickelt.

Zu den Ergebnissen zählen renommierte Preise für vorbildlich gestaltete Oberflächen, funktionelle Fortschritte wie geräuscharmes und rüttelfreies Befahren sowie mikrorauere Spezialglasuren für den Barfußbereich in Schwimmbädern. Die Qualität unserer rutschhemmenden Fliesen wird durch permanente Kontrollen der Werklabore gewährleistet und durch externe Institute sowie die Teilnahme an Ringversuchen mit akkreditierten Prüflabors regelmäßig neutral überwacht.

Neueste Innovation bei rutschhemmenden Fliesen ist die R12V4

In Zusammenarbeit mit dem deutschen Designer Sebastian Herkner wurde eine spezielle rutschhemmende Oberfläche für Area Pro entwickelt. Sebastian Herkner war auf der Suche nach einem Muster, das spontan wirkt und dennoch eine gewisse Logik aufweist. So kam er zu den sich wiederholenden, trapezförmigen Rechtecken und dem Muster, das sich in alle vier Richtungen fortsetzen lässt. Area Pro ist mit diversen rutschhemmenden Oberflächen erhältlich, darunter Grid, mit einer Rutschhemmung von R12V4. Keine der rutschhemmenden Oberflächen beeinträchtigt die Ästhetik der Fliesen. Sie sind auch für großformatige Fliesen verfügbar, die aufgrund ihrer Eigenschaften auch in Großküchen verwendet werden dürfen.



Designer Sebastian Herkner entwickelt die rutschhemmende Oberfläche „Grid“.



Funktionalität und Schönheit vereint:
Die Oberfläche R12V4 der Serie Area Pro.



Das Design von Grid.

Architektenservice

Effiziente Unterstützung seit sieben Jahrzehnten

Bei Agrob Buchtal gehören hochwertige Produkte und kompetente Dienstleistungen zusammen. So können Planer und Architekten, die unsere Produkte einsetzen, im Rahmen partnerschaftlicher Zusammenarbeit den seit 1952 bewährten Architektenservice nutzen.

Ein engagiertes Team qualifizierter Techniker, Ingenieure, Architekten, Designer und Farbexperten schafft die Voraussetzungen für eine schnelle, reibungslose Realisation individueller Konzepte. Und weil diese Experten neben ihrer Funktion als Fachberater auch zahlreiche Routineaufgaben übernehmen, können sich Kunden von Agrob Buchtal ganz auf die Umsetzung ihrer kreativen Ideen konzentrieren. Zum Leistungsspektrum zählen Verlegepläne, Mengenermittlungen, Leistungsverzeichnisse, Ausschreibungstexte oder die objektspezifische anwendungstechnische Beratung. Auf Wunsch steht auch ein Ansprechpartner vor Ort zur Verfügung.



Individualfertigung

für spezielle Anforderungen

Mehr als der Standard

Kreative Architekten und Planer brauchen grenzenlose gestalterische Freiräume, um ihre Ideen angemessen verwirklichen zu können.



Sonderfarben

werden aus nahezu 20.000 Glasrezepten in jedem gewünschten Ton individuell ausgewählt oder neu zusammengesetzt. Das gilt auch für Corporate Colors, die dem CD des jeweiligen Unternehmens entsprechen.



Wasserstrahltechnik

erlaubt den präzisen Schnitt von keramischen Fliesen und Platten in freien, auch geschwungenen Formen, die nach gestalterischen Vorgaben zusammengesetzt werden können.



Sonderformate

sind bei ästhetisch anspruchsvollen Neubauten ebenso gefragt wie bei der Sanierung historischer Bausubstanz und werden exakt nach Architekten-Vorgaben gefertigt.

Mosaic Designer

Free your mind

Mit dem neuen Mosaik-Planungstool erweitert Agrob Buchtal den Horizont für Architekten und Innenarchitekten um eine unendliche Anzahl von Lösungen in Form, Farbe und Größe. Der digitale Service schafft Freiraum für neue Ideen und überzeugt dank seiner intuitiven, fast spielerischen Handhabung mit einer exzellenten User-Experience. Ein Tool, mit dem Agrob Buchtal die alte Kunst des Mosaiks revolutioniert und zu neuem Leben erweckt.

Mittels Eingabe der gewünschten Basisparameter wie Maße der Mosaikfläche, Auswahl von Produktserie, Fliesenformat und Fugenfarbe können individuelle Farbverläufe oder Farbmischungen automatisch generiert werden. Je nach Größe wird in kürzester Zeit das gewünschte Design erzeugt und auf dem Bildschirm sichtbar gemacht.

Für eine Fläche von 3 x 6 Metern werden beispielsweise zahlreiche kleine Fliesen benötigt – diese werden blitzschnell

digital arrangiert und gestaltet. Bei der Größe gibt es keine Limitierung, was den Mosaic Designer von Agrob Buchtal vor allem bei der Gestaltung von Schwimmbädern und Wellness-Einrichtungen, Gastronomie, Hotels, Schulen und öffentlichen Bereichen wie zum Beispiel U-Bahn-Stationen zum kreativen Beschleuniger macht.

Zur Wahl stehen die drei Mosaikserien Loop, Fresh und Plural, die sich als reine Farbsystem-Serien ohne Oberflächen wie Holz, Beton, Marmor o. Ä. optimal eignen und mit einem breiten Spektrum an Tonwerten für die Gestaltung aufwarten. Jeder Entwurf kann als Projekt gespeichert oder sofort als Anfrage an Agrob Buchtal gesendet werden.

Neben grafischen Verläufen und Farbmischungen kann der Mosaic Designer auch individuelle Motive umsetzen. Per Upload-Funktion können Bilder und Fotos einfach direkt hochgeladen werden.

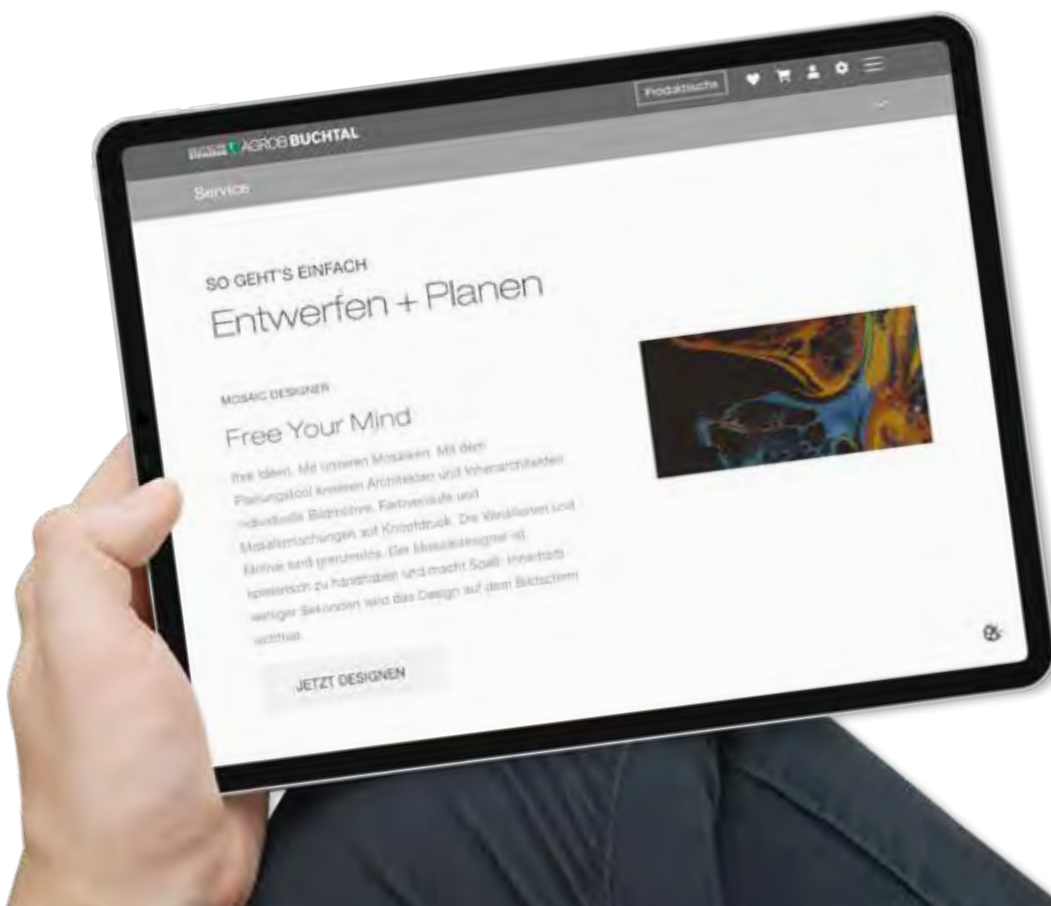

direkt zum Mosaic Designer



Wir entwickeln Produktlösungen für alle
Anwendungsbereiche



Retail

Retail-Konzepte benötigen hochwertige, authentische Materialien, die robust sind und starken Belastungen standhalten wie zum Beispiel unsere überstarken Fliesen. Oder spezielle Produktlösungen wie die mit Kork beschichtete Bodenfliese Drytile, die trocken verlegt wird. Das spart enorm viel Zeit und ist somit ein wirtschaftlicher Vorteil bei Neubau oder Sanierung.

Drytile – As fast as your business



Überstarke Fliesen





Hotel + Gastronomie

Hotels sind Zuhause auf Zeit. Eine rundum gelungene Innenarchitektur trägt dazu bei, dass Gäste sich wohlfühlen. Gefragt sind authentische Materialien, die Atmosphäre schaffen und den speziellen Reiz des Ortes herausstellen. Fliesen sind in der Architektur seit Jahrhunderten beliebtes und vielseitiges Gestaltungsmittel. Qualitativ hochwertige Keramik ist belastbar, verschleißarm, farbecht, leicht zu reinigen und somit wirtschaftlich.

Bunte Fliesen als Designstatement



Mosaik für den Wellnessbereich





Gesundheit + Pflege

In Gesundheits- und Pflegeeinrichtungen steht das Wohl von Patienten an erster Stelle – ob in Patientenzimmern, OP-Bereichen, Behandlungsräumen, Großküchen, Laboren oder Therapiebädern. Die Standards an Hygiene, Sauberkeit und Barrierefreiheit sind sehr hoch. Gleichzeitig wünschen Betreiber eine anspruchsvolle Innenarchitektur mit beruhigender und freundlicher Atmosphäre. Diese wirkt sich positiv auf das Wohlbefinden der Patienten aus und begünstigt somit die Genesung. Auch für besondere Anforderungen in Gesundheitseinrichtungen bieten wir Sonderprodukte: Keramik mit Spezialglasur absorbiert störende Reflexionen – extra konzipiert für OP-Räume und Bereiche, wo Lasertechnik zum Einsatz kommt. Sonderlösungen für Therapiebecken verbinden Funktionalität mit schönem Design.

Therapiebereiche



Keramik gegen Keime





Bildung

Schulen, Kindergärten und Universitäten sind Orte der Bildung genau wie politische, künstlerische oder musikalische Einrichtungen. Ein ansprechend gestaltetes Umfeld steigert die Lernbereitschaft und wirkt inspirierend. Und wenn Menschen sich wohlfühlen, kommen sie gerne wieder. Farbe ist ein wichtiges Element, um Räumen Atmosphäre und Ausdruck zu verleihen. Im Zusammenspiel mit Material und Textur entsteht zum Beispiel in Kitas oder Grundschulen ein positives, aktivierendes Umfeld. Farbtiefe, Brillanz und Ausdruckskraft von Keramik sind von Dauer. Auch den Beanspruchungen durch ständigen Publikumsverkehr trotz qualitativ hochwertige Keramik über Jahrzehnte.

Modulare Farbsysteme



Blindenleitsystem

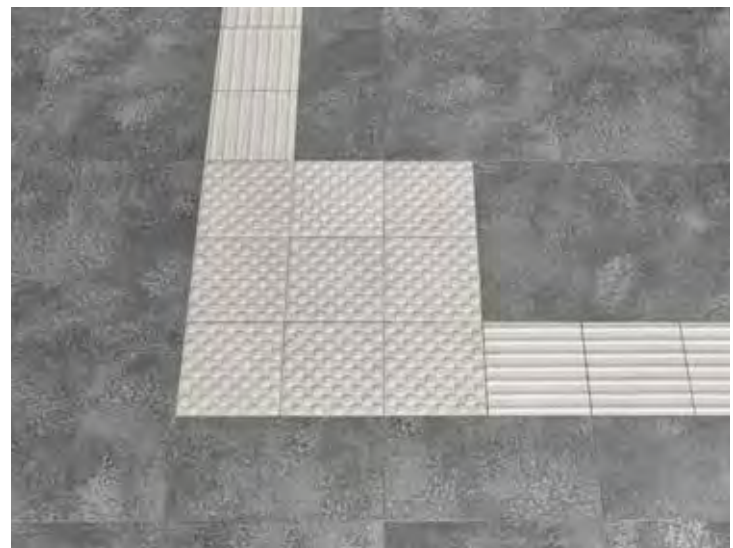



Industrie + Infrastruktur

Die Planung und Ausführung von Infrastrukturbauten sind herausfordernd. Bauwerke wie Bahnhöfe, U-Bahnstationen, Tunnel oder Flughäfen sollen multifunktional sein, ansprechend aussehen und zum Stadtbild passen. In diesen Bereichen begegnen sich täglich tausende Menschen. Hochfrequentierte Bereiche erfordern rutschhemmende, belastbare und wartungsarme Baustoffe. Aber genauso reinigungsfreundliche Oberflächen. Hier spielt die Hytect-Fliese ihre Vorteile aus. Die patentierte Oberflächenveredelung aktiviert einen natürlichen Prozess, der die Luft reinigt und Stickoxide sowie Gerüche neutralisiert. Ebenso sind unerwünschte Schmierereien wie Graffiti nachweislich leicht entfernbar. Spezialprodukte wie Blindenleitsysteme geben Orientierung und ermöglichen eine barrierefreie Konzeption.





Pool + Spa

Die Konzeption zeitgemäßer Bäderarchitektur ist komplex und muss hohen Anforderungen gerecht werden. Und das nicht nur in der Gestaltung: Ob Sport-, Freizeit- und Erlebnisbäder, Therapiebäder, Privat- und Hotelbäder, Sport- und Wettkampfbecken – sie alle müssen sicher sein, leicht zu reinigen und günstig in der Unterhaltung. Fliesen erfüllen diese funktionalen Ansprüche: Zum Beispiel durch rutschhemmende Spezialoberflächen, die selbst bei Nässe sicheren Halt bieten. Für eine konsistente Gestaltung vom Becken und Beckenumgang bis hin zu allen angrenzenden Bereichen wie Duschen, Saunen, Umkleiden oder Restaurants sind modular kombinierbare Fliesen und Formteile wichtig.

Weitere Informationen zu den Produkten enthält das Lieferprogramm Pool + Spa.

Durchgängiges Design in allen Poolbereichen



Farbverläufe



Drinnen wie draußen

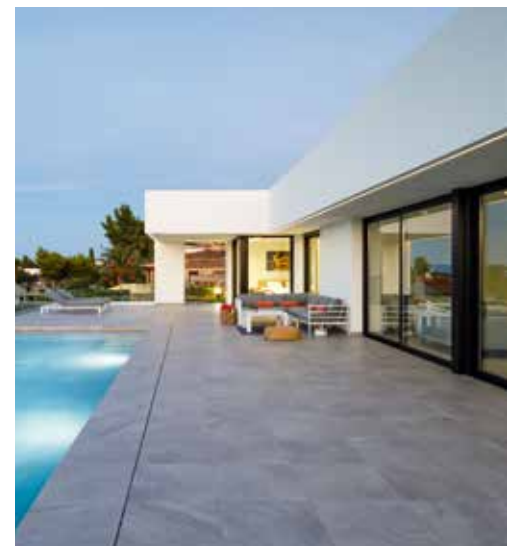



Fassade

Die Fassade ist mehr als eine schützende Außenhülle. Sie verhüllt das Gebäude wie ein Kleid. Ihre Gestaltung prägt nicht nur den Baukörper selbst, sondern wirkt auch – oft weithin sichtbar – auf das urbane Umfeld ein. Als Baustoff, der sich schon seit Jahrtausenden bewährt hat, bringt Keramik ideale Eigenschaften auch für die Fassade mit. Sie ist nicht brennbar, chemikalienresistent, lichtecht, druck-, stoß- und kratzfest. Außerdem ist sie baubiologisch unbedenklich. Sie punktet mit ihrer unbegrenzten Lebensdauer und kann komplett recycelt werden. Die Möglichkeiten der Gestaltung ergeben sich durch die Kombination von Farbe, Oberfläche, Format und Form in allen denkbaren Ausführungen: kraftvolle, satte Farben oder monochrome zurückhaltende. Glasierte, unglasierte, matte oder glänzende Oberflächen. Großformatige Platten, schmale Riegelformate oder Mosaik für organische Formen. Dreidimensionale Formen, Baguettes oder Rohre.

KerAion®



KeraShape®



KeraTwin®



KeraJoin®



KeraYou®





Living

Wand- und Bodenbeläge prägen den Gesamteindruck von Räumen maßgeblich. Bei der Planung zeitgemäßer Bäder und Wohnräume steht meist das Design an erster Stelle, wenn es um die Wahl von Wand- und Bodenbelägen geht. Gleichzeitig sollen die Materialien zur Ausstattung von Arbeits- oder Esszimmer, Flur, Wohn- oder Badezimmer aber auch strapazierfähig und langlebig sein. Es kommt darauf an, Wohnkomfort ohne Kompromisse zu schaffen, ökologisch nachhaltig, pflegeleicht und barrierefrei. Wir bieten Produkte, die diese Anforderungen erfüllen und mit den Vorteilen der antibakteriellen Hytect-Oberfläche smarten Zusatznutzen schaffen. Vom Mosaik bis hin zu Großformaten.

Bäder





Küche

Wohnen



Terrassen



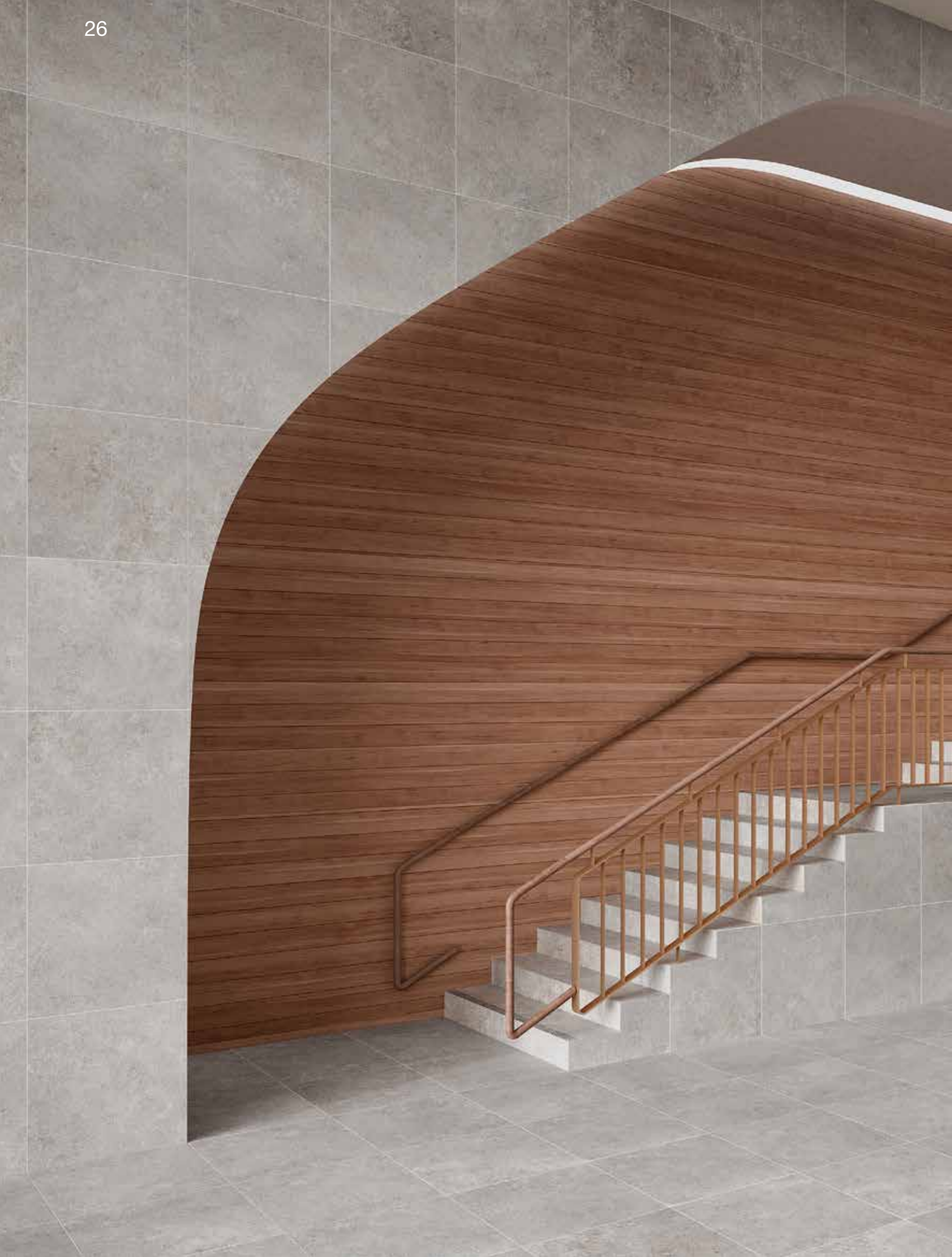



Produktfinder

	Uni	Bunt	Beton	Holz	Industrial	Marmor	Stein	Vintage	Hytect	Protecta	F9	R10	R10/A	R10/A+B	R10/B	R11	R11/A	R11/B	R11/C	R11V4	R12	R12/C	R12V4	R12V8	R13	R13V10	-/B	-/C	
	Optik										Rutschhemmung																		
	•						•	•	•																				
	•							•	•																				
					•		•	•	•				•	•	•	•		•	•				•	•					
							•	•	•		•																		
							•	•	•				•																
	•	•				•	•																						
	•						•	•	•																				
	•						•		•							•													
							•	•		•		•	•	•	•				•					•	•	•	•	•	
	•						•		•			•	•	•	•				•				•						
	•							•	•																				
					•		•	•	•		•				•														
	•							•																					
	•							•																					
	•							•																					
	•							•																					
	•							•																					
	•	•						•																					
	•						•	•		•																			
	•							•																					
	•	•						•																					
	•							•																					

¹Verwendbarkeit entspricht DIN 18515-1 oder entspr. des Verwendbarkeitsnachweises des Systemgebers.

20 x 20 cm	20 x 25 cm	20 x 40 cm	20 x 60 cm	25 x 25 cm	25 x 30 cm	25 x 33 cm	25 x 50 cm	30 x 30 cm	30 x 60 cm	30 x 90 cm	30 x 120 cm	31 x 30 cm	31 x 145 cm	35 x 100 cm	40 x 120 cm	50 x 25 cm	50 x 100 cm	60 x 60 cm	60 x 120 cm	80 x 80 cm	90 x 90 cm	100 x 100 cm	120 x 120 cm
								•	•								•						
•			•				•	•	•			•			•		•	•			•		
				•		•		•	•								•	•	•				
•	•	•			•			•	•				•										
•								•	•														
•								•	•														
								•	•									•					
								•						•									
			•		•			•	•														
				•		•																	
								•															
											•												
•			•				•	•										•					
								•	•									•					
								•	•	•								•		•			
								•										•					
								•										•					
																					•		

Serie	Ab Seite	Produktkategorie								Farbe																		
		Bodenfliesen	Bodenfliesen überstark	Dekoration	Duschböden	Mosaik	Schwimmbad	Sockel	Terrassenplatten	Treppenfliesen	Wandfliesen	Für Fassade geeignete Prod.!	Weiß	Hellgrau	Mittelgrau	Dunkelgrau	Schwarz	Hellblau	Mittelblau	Dunkelblau	Beige	Braun	Gelb	Orange	Rot	Grün	Bunt	Metallic
Lounge	264	•	•	•	•				•			•	•	•	•						•							•
Mandalay	274		•							•		•	•		•	•												•
Mando	278		•							•		•	•					•		•	•							
Marble & More	284				•							•		•		•		•	•								•	
Naturkeramik	288	•																		•	•							
New Market	292		•									•	•	•	•	•				•	•							
Nivella	300																	•										
Nova	302	•			•		•		•				•	•	•					•	•							
Oak	310	•	•				•		•					•							•							
Ocean	316				•					•		•					•	•	•							•		
Pattern	322	•			•					•		•	•	•			•		•								•	
Pizarro	334		•							•		•	•	•														
Plural	338	•			•		•			•		•	•	•	•	•	•	•	•	•	•	•	•	•	•	•	•	
Plural non-slip	358	•		•	•		•					•	•	•	•	•	•	•	•	•	•	•	•	•	•	•	•	
Plural unglasiert	366	•			•		•						•	•	•			•	•	•	•	•	•	•	•	•	•	
Quarzit	372	•		•	•	•	•	•	•			•	•							•	•							
Savona	380	•			•		•					•	•	•	•					•	•							
Senja Pure	386				•					•		•	•							•	•							•
Sento	392	•	•		•		•			•		•	•	•	•	•	•	•	•	•	•	•	•	•	•	•	•	
Sierra	400	•			•		•		•			•		•	•					•								
Skill	406	•					•		•			•	•	•						•								
Solid Ground	412	•	•		•		•		•	•		•	•	•						•	•							
Solid Rock	424	•	•		•		•	•	•			•	•	•												•		
Stone Concept	432		•							•																		
Stone Duo	438	•	•		•		•		•			•	•		•													
Stories	446	•	•		•		•	•	•	•		•	•	•						•								
Strata	456	•	•		•		•		•			•	•	•	•					•	•							
Streetlife Metallic	468	•					•		•												•							
Trio	472	•	•		•		•	•	•	•		•		•	•	•	•	•	•	•	•	•	•	•	•	•	•	
Unique	482	•	•		•		•		•			•		•	•					•	•							•
Valley	488	•			•	•	•	•	•				•	•	•					•	•							
Walden	494	•					•				•									•	•							

	Uni	Bunt	Beton	Holz	Industrial	Marmor	Stein	Vintage	Hytect	Protecta	F9	R10	R10/A	R10/A+B	R10/B	R11	R11/A	R11/B	R11/C	R11V4	R12	R12/C	R12V4	R12V8	R13	R13V10	-/B	-/C	
	Optik										Rutschhemmung																		
					•	•		•						•															
		•	•			•																							
			•					•																					
					•	•		•						•					•	•									
		•	•			•		•	•			•																	
		•						•					•						•	•									
			•					•					•																
	•	•				•		•																					
	•					•		•																					
	•							•																					
					•			•					•																
	•					•		•																					
	•							•																					
	•							•																					
						•																							
		•						•																					
	•	•				•		•	•																				
						•		•																					
			•					•																					

¹Verwendbarkeit entspricht DIN 18515-1 oder entspr. des Verwendbarkeitsnachweises des Systemgebers.



Serien A-Z







Warm und natürlich

Für Wand und Boden in Wohn- und Nassbereichen bietet Alcina mit ihren natürlich strukturierten Oberflächen eine elegante Palette an erdigen und warmen Tönen. So lässt sich Alcina mit verschiedenen Wohnstilen kombinieren. Die zart eingefärbten Wandfliesen verfügen über eine Hytect-Oberfläche. Starke oder dezente Kontraste dazu bilden Bodenfliesen in unterschiedlichen Farben und Formaten. Für stilvolle Abwechslung sorgt die Schnittdekoration Sola – in allen Bodenfarben. Passende Sockel, ein trittsicheres 5 x 5-Mosaik sowie Terrassenplatten runden das breite Fliesenprogramm ab.

Rendering / Architekt: Stellwerk architekten

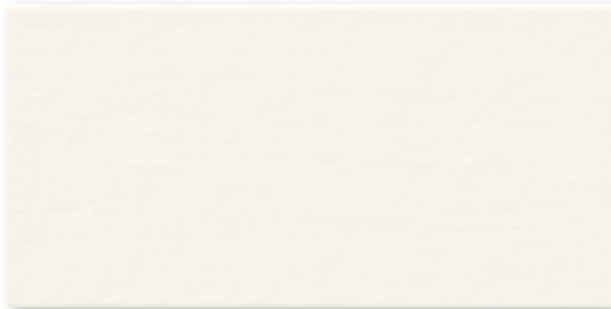

Wandfliese 30 x 60 cm, weiß, strukturiert

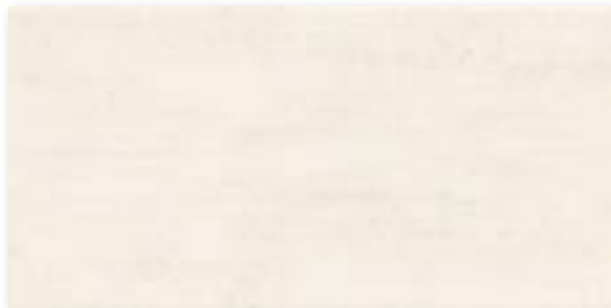

Wandfliese 30 x 60 cm, beige, strukturiert

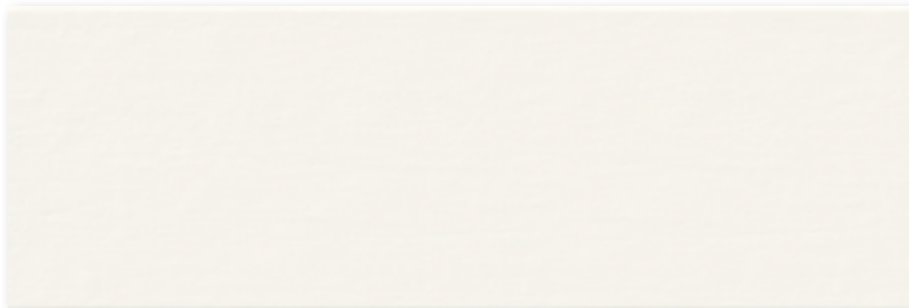

Wandfliese 30 x 90 cm, weiß, strukturiert



Wandfliese 30 x 90 cm, beige, strukturiert

Dekorationselemente



Bordüre Sola 24,3 x 43,8 cm, crema, strukturiert



Bordüre Sola 24,3 x 43,8 cm, lehm-braun, strukturiert,



Bordüre Sola 24,3 x 43,8 cm, kieselgrau, strukturiert

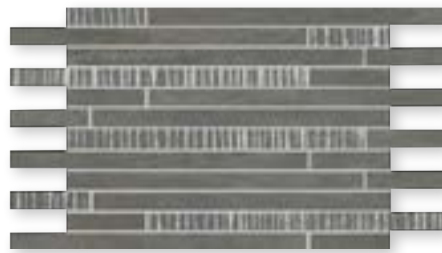

Bordüre Sola 24,3 x 43,8 cm, basalt, strukturiert

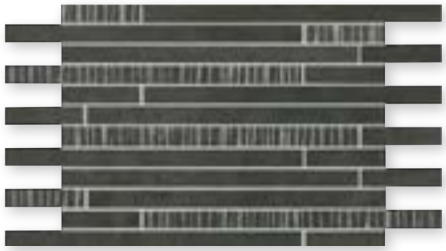

Bordüre Sola 24,3 x 43,8 cm, graphit, strukturiert

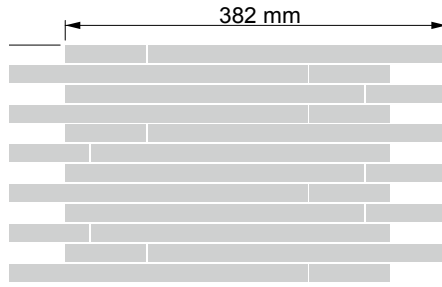

Bordüre: Verklebung rückseitig auf Glasfasernetz
Bogen: 240 x 435 mm

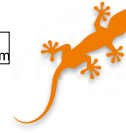

R10/A+B



crema



lehm Braun



kieselgrau

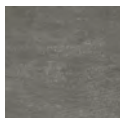

basalt



graphit



Bodenfliese 30 x 60 cm, strukturiert, R10/A+B



Bodenfliese 60 x 60 cm, strukturiert, R10/A+B



Sockel, geschnitten 7 x 60 cm, strukturiert

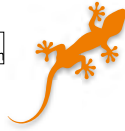

R10/A+B R11/B



Mosaik 5 x 5 cm



Mosaikbogen 30 x 30 cm, crema strukturiert, R10/A+B

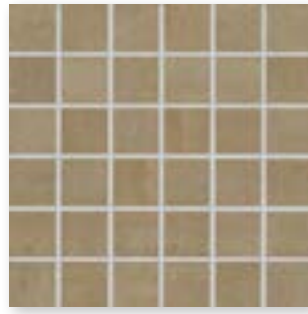

Mosaikbogen 30 x 30 cm, lehm Braun strukturiert, R10/A+B



Mosaikbogen 30 x 30 cm, kieselgrau strukturiert, R10/A+B

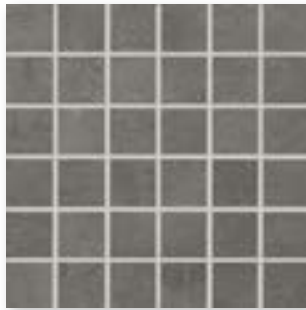

Mosaikbogen 30 x 30 cm, basalt strukturiert, R10/A+B

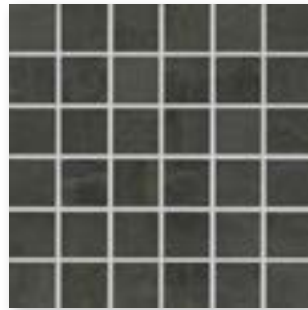

Mosaikbogen 30 x 30 cm, graphit strukturiert, R10/A+B

Mosaik: Verklebung rückseitig auf Glasfasernetz,
Bogen: 297 x 297 mm



kieselgrau

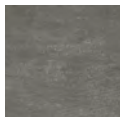

basalt

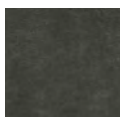

graphit



Terrassenplatte 60 x 60 cm, strukturiert, R11/B

Wandfliesen⁵

30 x 60 cm



30 x 90 cm¹

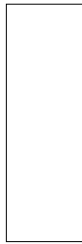

Dekorations-
elemente^{2/3/4/6/7}

24,3 x 43,8 cm

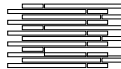

Bordüre Sola,
Bogen: 240 x 435 mm

Nennmaß - cm/in	30 x 60 / 12 x 24	30 x 90 / 12 x 36	24,3 x 43,8 / 10 x 18				
Herstellmaß	297 x 597 x 6 mm	297 x 897 x 6 mm	240 x 435 x 6 mm				
Oberfläche	strukturiert, seidenmatt	strukturiert, seidenmatt	strukturiert, matt				
m ² /m - St.	5,556/m ²	3,704/m ²	2,639/m				
m ² /m - kg	10,279/m ²	10,400/m ²	3,077/m				
Paket - St.	13	8	3				
Paket - m ² /m	2,340 m ²	2,160 m ²	1,137 m				
Paket - kg	24,050	22,464	3,498				
Palette - m ²	112,311	51,836					
Palette - kg	1.154,400	539,136					
Produktnorm	BIII	BIII	Bla				
weiß <input type="checkbox"/> V1	203435H Preisgr. C68 (m ²)	323437H Preisgr. C134 (m ²)					
beige <input type="checkbox"/> V2	203436H Preisgr. C68 (m ²)	323438H Preisgr. C134 (m ²)					
crema <input type="checkbox"/> V2			203439 Preisgr. C510 (St.)				
lehmbraun <input type="checkbox"/> V2			203440 Preisgr. C510 (St.)				
kieselgrau <input type="checkbox"/> V2			203441 Preisgr. C510 (St.)				
basalt <input type="checkbox"/> V2			203442 Preisgr. C510 (St.)				
graphit <input type="checkbox"/> V2			203443 Preisgr. C510 (St.)				

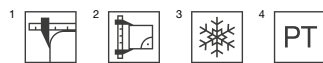

⁵ nicht frostsicher

⁶ Verklebung rückseitig auf Glasfasernetz

⁷ Abgabe der Dekorationselemente ausschließlich in vollen Kartons.

Mosaik^{1/2}

5 x 5 cm



Bodenfliesen¹

30 x 60 cm

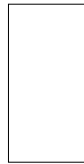

60 x 60 cm

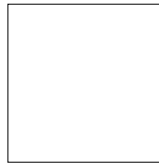

Sockel,
geschnitten¹

7 x 60 cm



Terrassen-
platten^{1/3/4}

60 x 60 cm

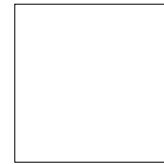

protected

Bogen: 297 x 297 mm

	5 x 5 / 2 x 2	30 x 60 / 12 x 24	60 x 60 / 24 x 24	7 x 60 / 2 13/16 x 24	60 x 60 / 24 x 24	Nennmaß - cm/in
	47 x 47 x 6	297 x 597 x 6 mm	597 x 597 x 6 mm	70 x 597 x 6 mm	597 x 597 x 20 mm	Herstellmaß
	strukturiert, matt	strukturiert, matt	strukturiert, matt	strukturiert, matt	strukturiert, matt	Oberfläche
	11,111 Bögen	5,556/m ²	2,778/m ²	1,667/m	2,778/m ²	m ² /m - Stück
	11,488/m ²	13,273/m ²	13,581/m ²	0,938/m	45,273/m ²	m ² /m - kg
	11 Bögen	10	5	38	2	Paket - Stück
	0,990 m ²	1,800 m ²	1,800 m ²	22,795 m	0,720 m ²	Paket - m ² /m
	11,374	23,890	24,445	21,394	32,594	Paket - kg
	35,640	71,994	64,795		21,598	Palette - m ²
	409,464	955,600	880,020		977,820	Palette - kg
	Bla	Bla	Bla	Bla	Bla	Produktnorm
	R10/A+B	R10/A+B	R10/A+B		R11/B	Trittsicherheit
	1	1	1		4	Belastung
	431480	431485	431490	431495		crema <input type="checkbox"/> V2
	Preisgr. C308 (m ²)	Preisgr. C98 (m ²)	Preisgr. C107 (m ²)	Preisgr. C440 (St.)		
	431481	431486	431491	431496		lehmbraun <input type="checkbox"/> V2
	Preisgr. C308 (m ²)	Preisgr. C98 (m ²)	Preisgr. C107 (m ²)	Preisgr. C440 (St.)		
	431482	431487	431492	431497	434983H	kieselgrau <input type="checkbox"/> V2
	Preisgr. C308 (m ²)	Preisgr. C98 (m ²)	Preisgr. C107 (m ²)	Preisgr. C440 (St.)	Preisgr. C200 (m ²)	
	431483	431488	431493	431498	434984H	basalt <input type="checkbox"/> V2
	Preisgr. C308 (m ²)	Preisgr. C98 (m ²)	Preisgr. C107 (m ²)	Preisgr. C440 (St.)	Preisgr. C200 (m ²)	
	431484	431489	431494	431499	434985H	graphit <input type="checkbox"/> V2
	Preisgr. C308 (m ²)	Preisgr. C98 (m ²)	Preisgr. C107 (m ²)	Preisgr. C440 (St.)	Preisgr. C200 (m ²)	



- ¹ Verklebung rückseitig auf Glasfasernetz
² Hohes Gewicht! Karton bitte nur zu Zweit transportieren.
³ ohne Protecta-Vergütung; mit Hytect-Veredelung.







Tief beeindruckend und lebendig

Inspiziert von der Bewegung des Wassers setzt Amano auf eine weich zeichnende Reliefoberfläche. In Kombination mit fließenden Glasuren erzeugt Amano aquarellähnliche Effekte und verleiht der Serie natürlichen Charme sowie exklusive Lebendigkeit. Amano wird getragen durch zart-transparente, gedeckte Farben sowie weiche Kontraste. Bricht sich das Licht auf der glänzenden Oberfläche beeindruckt Amano mit funkelnden Reflexionen.

Studioaufnahme / Architekt: Anne Doris Fluck / Foto: Jochen Stüber

Mosaik 2,5 x 2,5 cm



Mosaikbogen 30 x 30 cm
creme, reliefiert

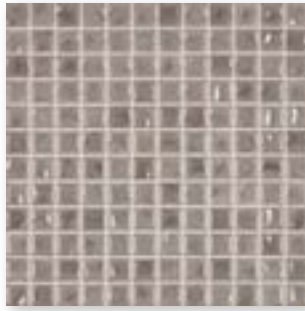

Mosaikbogen 30 x 30 cm
taupe, reliefiert

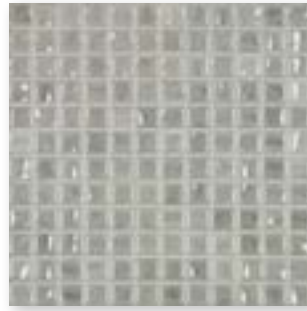

Mosaikbogen 30 x 30 cm,
hellgrau, reliefiert

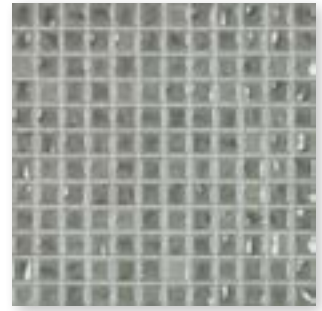

Mosaikbogen 30 x 30 cm
mittelgrau, reliefiert

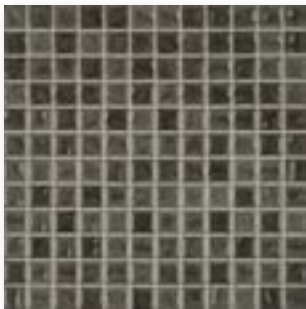

Mosaikbogen 30 x 30 cm
anthrazit, reliefiert

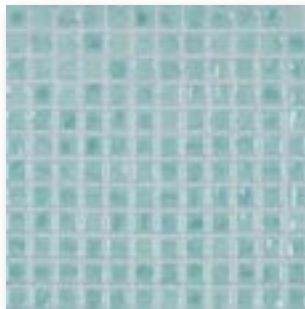

Mosaikbogen 30 x 30 cm
eisblau, reliefiert

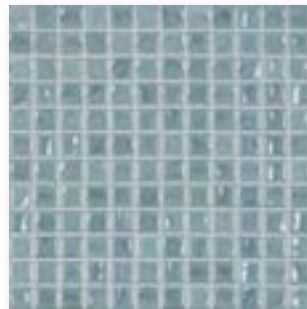

Mosaikbogen 30 x 30 cm
seidenblau, reliefiert



Mosaikbogen 30 x 30 cm
pur blau, reliefiert



Mosaikbogen 30 x 30 cm
metallic, reliefiert



Mosaikbogen 30 x 30 cm
mittelgrau-metallic-mix, reliefiert

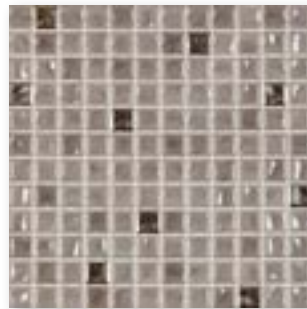

Mosaikbogen 30 x 30 cm
taupe-metallic-mix, reliefiert



Rückseitig thermoplastisch verklebte Mosaike von Agrob Buchtal sind nicht nur im Trockenbereich, sondern auch bedenkenlos im Unterwasserbereich (z. B. Schwimmbecken/Whirlpool) sowie im dauernassbelasteten Bereich einsetzbar.

Rendering





Natürlich intuitiv

Gutes Design vermittelt immer einen intuitiven Zugang zu dessen Nutzung – so geht auch das Gestalten mit Area Pro leicht von der Hand. Die breite Produktpalette regt mit Erdtönen und einer angenehmen Haptik unmittelbar zu Ideen für ihren Einsatz an. Die von feinkörnigem, geschichtetem Kalkstein inspirierte Serie fügt sich mühelos ein und hebt sich zugleich ab. Das macht die Fliesen und ihr Zubehör zu perfekten Allroundern in fast jedem Ambiente. Die Serie strahlt bereits jetzt das Potenzial aus, ein



Rendering

Klassiker zu werden. Area Pro ist das keramische Pendant zum kleinen Schwarzen oder einem klassischen weißen Hemd. Ob in Bürogebäuden, Wohnhäusern oder Freizeiteinrichtungen – die Serie überzeugt, wie die Modeklassiker, in jeder Umgebung und ist damit ein wahres Multitalent. Alle Fliesen können richtungsunabhängig verlegt werden. Zudem bestechen sie durch ihre Vielseitigkeit und eine Vielzahl an Formaten und Farbtönen. Alle Farben von Area Pro sind auf die Serien Chroma und Plural von Agrob Buchtal abgestimmt, sodass sie vielfältig miteinander kombiniert werden können. Darüber hinaus sind mit dieser Serie auch maßgeschneiderte Projekte möglich.





Grid

Um dem eigenen Anspruch gerecht zu werden, hohe Funktionalität mit anspruchsvollem Design zu verbinden, verpflichtete Agrob Buchtal Design-Shootingstar Sebastian Herkner, der sonst für Marken wie Thonet, Ligne Roset oder Moroso tätig ist. Er kreierte einen völlig neuen Entwurf für die Oberfläche der höchsten Rutschhemmungsklasse. Das Ergebnis: the Grid.



Smarte Eigenschaften

Immer perfekter Halt



Area Pro ist mit diversen rutschhemmenden Oberflächen erhältlich, darunter Grid, mit einer Trittsicherheit von R12V4.

Nachhaltige, dünne Wandfliesen



Bei den 6 mm dünnen Wandfliesen ist der Materialaufwand geringer. Weniger Material bedeutet weniger Energie bei Herstellung und Transport sowie ein geringeres Gewicht.

Innovation Drytile



Das Drytile-System ist für die Bodenfliesen zwischen 30 x 60 cm und 60 x 120 cm erhältlich. Drytile ist eine innovative Technologie, bei der Fliesen auf der Rückseite mit Kork-Verbundstoff beschichtet und ohne den Einsatz von Kleber verlegt werden.

Hytect, die photokatalytische Oberfläche



Area Pro Fliesen sind mit der nachhaltigen Hytect-Oberfläche versehen, die sie höchst reinigungsfreundlich machen. Hytect schützt keramische Fliesen zudem vor Bakterien und Schimmel und neutralisiert Luftschadstoffe und störende Gerüche.

Abdeckrost aus Keramik



Für Fliesen, die in Schwimmbädern um das Becken herum verlegt werden, bietet Agrob Buchtal den passenden Abschluss, der für optische Kontinuität sorgt: einen Abdeckrost mit wasserstrahlgeschnittenen Öffnungen.



R10/A R10/B R11/B R11/C R12/C R12V4



Oberflächen: Bodenfliesen

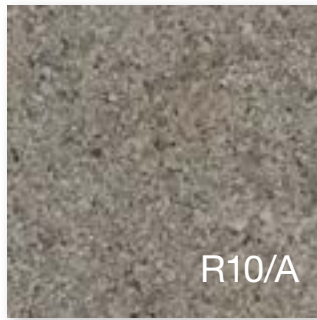

eben

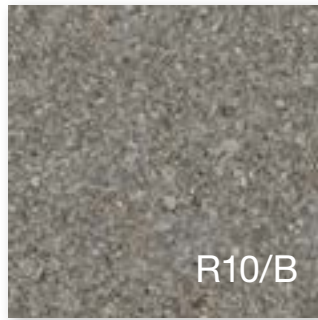

eben

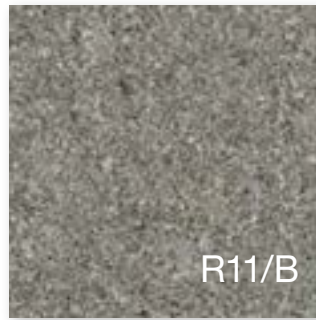

eben

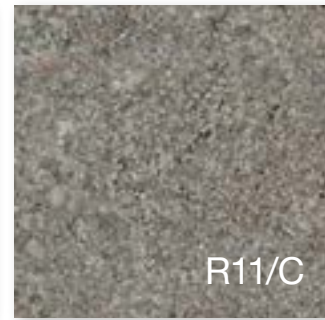

eben



ziegel



platin



lehm



sandgrau



muskat

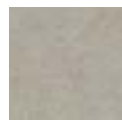

stein



sand



kiesel



sandbeige



basalt

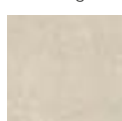

sandweiß



anthrazit



Bodenfliese 15 x 15 cm, eben, R10/B
Bodenfliese 15 x 15 cm, eben, R11/C



Bodenfliese 20 x 20 cm, eben, R10/A
Bodenfliese 20 x 20 cm, Softcorn 2, R11/B
Bodenfliese 20 x 20 cm, Perlstic, R12/C
Bodenfliese 20 x 20 cm, Grid, R12V4



Bodenfliese 30 x 30 cm, eben, R10/A
Bodenfliese 30 x 30 cm, eben, R11/B

Mosaik 5 x 5 cm



Mosaikbogen 30 x 30 cm, eben, R10/B

Mosaik 10 x 10 cm



Mosaikbogen 30 x 30 cm, eben, R10/B
Mosaikbogen 30 x 30 cm, eben, R11/C



Rückseitig thermoplastisch verklebte Mosaike von Agrob Buchtal sind nicht nur im Trockenbereich, sondern auch bedenkenlos im Unterwasserbereich (z. B. Schwimmbecken/Whirlpool) sowie im dauernassbelasteten Bereich (z. B. Beckenumgänge/Duschen) einsetzbar.

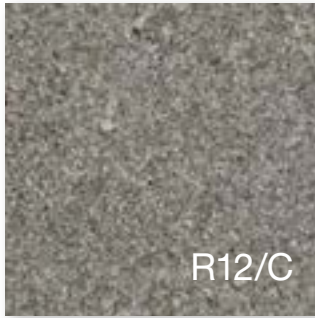

eben

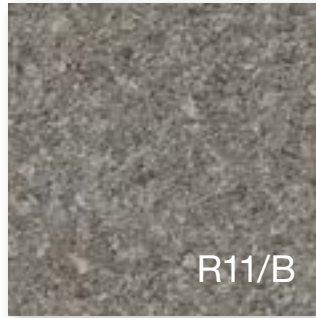

Softcorn 2

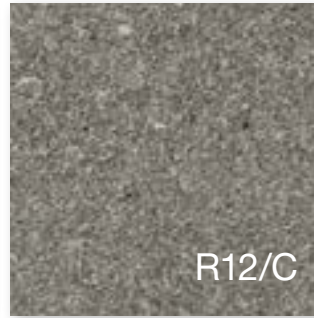

Perlstick



Grid



Riegelformat 10 x 60 cm, eben, R10/A



Riegelformat 15 x 60 cm, eben, R10/A



Bodenfliese 30 x 60 cm, eben, R10/A
Bodenfliese 30 x 60 cm, eben, R11/B
Bodenfliese 30 x 60 cm, eben, R12/C



Bodenfliese 60 x 60 cm, eben, R10/A
Bodenfliese 60 x 60 cm, eben, R11/B
Bodenfliese 60 x 60 cm, Grid, R12V4



R10/A R11/B



ziegel

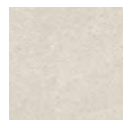

platin



lehm



sandgrau



muskat



stein



sand



kiesel



sandbeige



basalt



sandweiß



anthrazit



Bodenfliese 90 x 90 cm, eben, R10/A



Bodenfliese 60 x 120 cm, eben, R10/A
Bodenfliese 60 x 120 cm, eben, R11/B

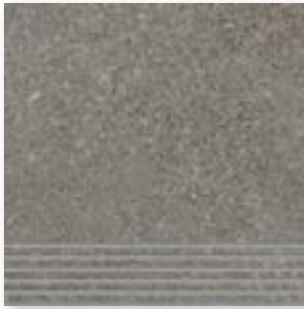

Treppenfliese 30 x 30 cm (rilliert), eben, R10/A

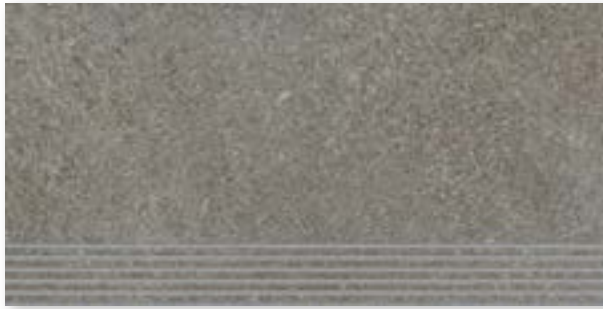

Treppenfliese 30 x 60 cm (rilliert), eben, R10/A



Treppenfliese mit Schräge 31 x 145 cm, eben, R10/A



Setzstufe 28 x 145 cm, eben, R10/A



Treppenkante 4 x 60 cm, eben, R10/A



R10/A R10/B R11 R11/B



ziegel

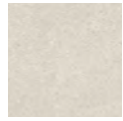

platin



lehm



sandgrau



muskat



stein



sand



kiesel

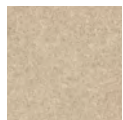

sandbeige



basalt



sandweiß



anthrazit



Sockel, gerundet 7 x 30 cm, eben



Sockel, gerundet 7 x 60 cm, eben



Hohlkehlsockel 10 x 10 cm
eben, R10/A



Hohlkehlsockel 10 x 20 cm
eben, R10/A



Hohlkehlsockel 10 x 30 cm
eben, R10/A



Hohlkehlsockel 10 x 60 cm, eben, R10/A



Innenecke
zu Hohlkehlsockel, eben



Außenecke
zu Hohlkehlsockel, eben



Duschtassensystem Läufer
10 x 10 cm, eben, R10/B



Duschtassensystem Ecke
10 x 10 cm, eben, R10/B



anthrazit

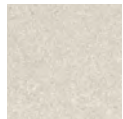

platin



Blindenleitfliese 30 x 30 cm,
Rippenstruktur, R11



Blindenleitfliese 30 x 30 cm,
Noppenstruktur, R11

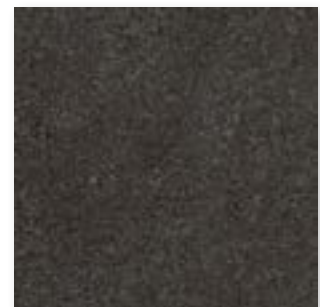

Blindenleitfliese 30 x 30 cm
eben, R11



sand



sandbeige



sandgrau



kiesel



basalt



anthrazit



Terrassenplatte 60 x 60 cm, eben, R11/B



sandbeige



sandgrau



basalt



Terrassenplatte Dekor Square, 60 x 60 cm, eben, R11/B

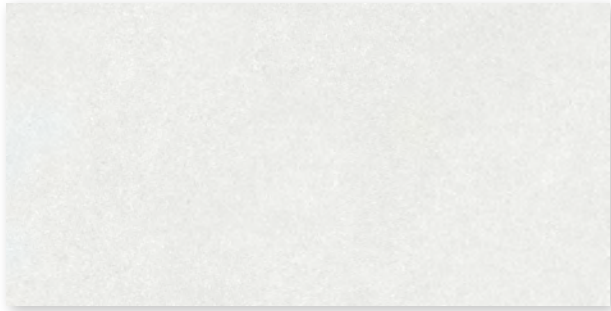

Wandfliese 30 x 60 cm, weiß, eben



Wandfliese 30 x 60 cm, grau, eben



Wandfliese 30 x 60 cm, beige, eben



Wandfliese 30 x 90 cm, weiß, eben

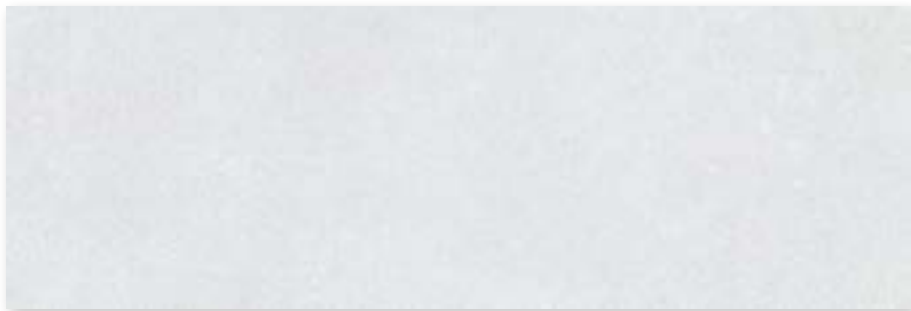

Wandfliese 30 x 90 cm, grau, eben



Wandfliese 30 x 90 cm, beige, eben



R11/B R11/C



ziegel

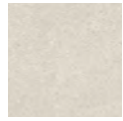

platin



lehm



sandgrau



muskat



stein



sand



kiesel

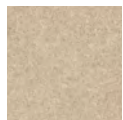

sandbeige



basalt



sandweiß



anthrazit

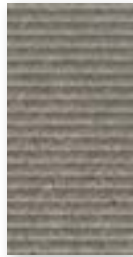

Rillenplatte 12,5 x 25 cm
gerillt, R11/C

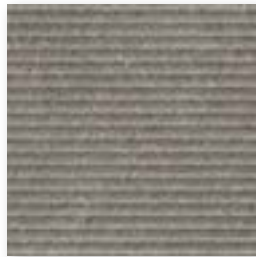

Rillenplatte 25 x 25 cm
gerillt, R11/C



Rillenplatte 50 x 25 cm
gerillt, R11/C

Flachrinnensystem (Muldentiefe 5 mm)



Flachrinne, 50 x 25 cm
eben, R11/B



Flachrinne Gehrungspaar
eben, R11/B



Flachrinne mit Ablauf
eben, R11/B



Endstück
eben, R11/B

Keramische Rinnenabdeckung

Keramische Rinnenabdeckung
25 x 50 cm



Keramische Rinnenabdeckung
Ecklösung 30 x 30 cm



Details zu Flachrinnen und Keramischer Rinnenabdeckung
siehe Lieferprogramm Pool + Spa.

Wandfliesen⁴

Mosaik^{1/2}

30 x 60 cm



30 x 90 cm³

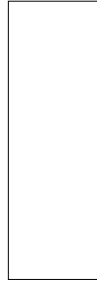

5 x 5 cm



10 x 10 cm



10 x 10 cm



	30 x 60 / 12 x 24	30 x 90 / 12 x 36	5 x 5 / 2 x 2	10 x 10 / 4 x 4	10 x 10 / 4 x 4		
Nennmaß - cm/in	297 x 597 x 6 mm	297 x 897 x 6 mm	47 x 47 x 6,5 mm	97 x 97 x 6,5 mm	97 x 97 x 6,5 mm		
Herstellmaß	297 x 597 x 6 mm	297 x 897 x 6 mm	47 x 47 x 6,5 mm	97 x 97 x 6,5 mm	97 x 97 x 6,5 mm		
Oberfläche	eben, steinmatt	eben, steinmatt	eben, matt	eben, matt	eben, matt		
m ² - Stück	5,556	3,704	11 Bögen	11 Bögen	11 Bögen		
m ² - kg	10,279	10,400	12,331	13,101	13,101		
Paket - Stück	13	8	11 Bögen	11 Bögen	11 Bögen		
Paket - m ²	2,340	2,160	1,000	1,000	1,000		
Paket - kg	24,050	22,464	12,331	13,101	13,101		
Palette - m ²	112,311	51,836	64,000	64,000	64,000		
Palette - kg	1.154,400	539,136	789,184	838,464	838,464		
Produktnorm	BIII	BIII	Bla	Bla	Bla		
Trittsicherheit			R10/B	R10/B	R11/C		
Belastung			1	1	1		
weiß <input type="checkbox"/>	203232H Preisgr. A76 (m ²)	323235H Preisgr. A166 (m ²)					
grau <input type="checkbox"/>	203233H Preisgr. A76 (m ²)	323236H Preisgr. A166 (m ²)					
beige <input type="checkbox"/>	203234H Preisgr. A76 (m ²)	323237H Preisgr. A166 (m ²)					
anthrazit <input type="checkbox"/>			430185H Preisgr. A196 (m ²)	430220H Preisgr. A148 (m ²)	430232H Preisgr. A148 (m ²)		
basalt <input type="checkbox"/>			430186H Preisgr. A196 (m ²)	430221H Preisgr. A148 (m ²)	430233H Preisgr. A148 (m ²)		
kiesel <input type="checkbox"/>			430187H Preisgr. A196 (m ²)	430222H Preisgr. A148 (m ²)	430234H Preisgr. A148 (m ²)		
stein <input type="checkbox"/>				430223H Preisgr. A148 (m ²)	430235H Preisgr. A148 (m ²)		
sandweiß <input type="checkbox"/>				430224H Preisgr. A148 (m ²)	430236H Preisgr. A148 (m ²)		
sandgrau <input type="checkbox"/>			430188H Preisgr. A196 (m ²)	430225H Preisgr. A148 (m ²)	430237H Preisgr. A148 (m ²)		
sand <input type="checkbox"/>			430189H Preisgr. A196 (m ²)	430226H Preisgr. A148 (m ²)	430238H Preisgr. A148 (m ²)		
muskat <input type="checkbox"/>				430227H Preisgr. A148 (m ²)	430239H Preisgr. A148 (m ²)		
platin <input type="checkbox"/>			435569H NEU Preisgr. A196 (m ²)	430228H Preisgr. A148 (m ²)	430240H Preisgr. A148 (m ²)		
sandbeige <input type="checkbox"/>			430190H Preisgr. A196 (m ²)	430229H Preisgr. A148 (m ²)	430241H Preisgr. A148 (m ²)		
ziegel <input type="checkbox"/>				430230H Preisgr. A148 (m ²)	430242H Preisgr. A148 (m ²)		
lehm <input type="checkbox"/>				430231H Preisgr. A148 (m ²)	430243H Preisgr. A148 (m ²)		



⁴ nicht frostsicher

Bodenfliesen

15 x 15 cm



15 x 15 cm



20 x 20 cm



20 x 20 cm



20 x 20 cm



20 x 20 cm



Softcorn 2

Perlstic

Grid

	15 x 15 / 6 x 6	15 x 15 / 6 x 6	20 x 20 / 8 x 8	20 x 20 / 8 x 8	20 x 20 / 8 x 8	20 x 20 / 8 x 8	Nennmaß - cm/in
	147 x 147 x 10,5 mm	147 x 147 x 10,5 mm	197 x 197 x 10,5 mm	197 x 197 x 10,5 mm	197 x 197 x 10,5 mm	197 x 197 x 10,5 mm	Herstellmaß
	eben, matt	eben, matt	eben, matt	strukturiert, matt	gekörnt, matt	profiliert, matt	Oberfläche
	44,444	44,444	25,000	25,000	25,000	25,000	m ² - Stück
	23,111	23,111	22,900	22,900	22,900	22,900	m ² - kg
	27	27	21	21	21	21	Paket - Stück
	0,607	0,607	0,840	0,840	0,840	0,840	Paket - m ²
	14,040	14,040	19,236	19,236	19,236	19,236	Paket - kg
	48,600	48,600	50,400	50,400	50,400	50,400	Palette - m ²
	1.123,200	1.123,200	1.154,160	1.154,160	1.154,160	1.154,160	Palette - kg
	Bla	Bla	Bla	Bla	Bla	Bla	Produktnorm
	R10/B	R11/C	R10/A	R11/B	R12/C	R12V4	Trittsicherheit
	3	3	3	3	3	3	Belastung
	430244H	430256H	430268H	430274H	430280H	430286H	anthrazit <input type="checkbox"/> V2
	Preisgr. A142 (m ²)	Preisgr. A142 (m ²)	Preisgr. A133 (m ²)	Preisgr. A133 (m ²)	Preisgr. A157 (m ²)	Preisgr. A157 (m ²)	
	430245H	430257H	430269H	430275H	430281H	430287H	basalt <input type="checkbox"/> V2
	Preisgr. A142 (m ²)	Preisgr. A142 (m ²)	Preisgr. A133 (m ²)	Preisgr. A133 (m ²)	Preisgr. A157 (m ²)	Preisgr. A157 (m ²)	
	430246H	430258H	430270H	430276H	430282H	430288H	kiesel <input type="checkbox"/> V2
	Preisgr. A142 (m ²)	Preisgr. A142 (m ²)	Preisgr. A133 (m ²)	Preisgr. A133 (m ²)	Preisgr. A157 (m ²)	Preisgr. A157 (m ²)	
	430249H	430261H	430271H	430277H	430283H	430289H	sandgrau <input type="checkbox"/> V2
	Preisgr. A142 (m ²)	Preisgr. A142 (m ²)	Preisgr. A133 (m ²)	Preisgr. A133 (m ²)	Preisgr. A157 (m ²)	Preisgr. A157 (m ²)	
	430250H	430262H	430272H	430278H	430284H	430290H	sand <input type="checkbox"/> V2
	Preisgr. A142 (m ²)	Preisgr. A142 (m ²)	Preisgr. A133 (m ²)	Preisgr. A133 (m ²)	Preisgr. A157 (m ²)	Preisgr. A157 (m ²)	
	435570H NEU	435571H NEU	435572H NEU	435573H NEU	435574H NEU	435575H NEU	platin <input type="checkbox"/> V2
	Preisgr. A142 (m ²)	Preisgr. A142 (m ²)	Preisgr. A133 (m ²)	Preisgr. A133 (m ²)	Preisgr. A157 (m ²)	Preisgr. A157 (m ²)	
	430253H	430265H	430273H	430279H	430285H	430291H	sandbeige <input type="checkbox"/> V2
	Preisgr. A142 (m ²)	Preisgr. A142 (m ²)	Preisgr. A133 (m ²)	Preisgr. A133 (m ²)	Preisgr. A157 (m ²)	Preisgr. A157 (m ²)	



Bodenfliesen

30 x 30 cm



30 x 30 cm



10 x 60 cm^{1/2}



15 x 60 cm^{1/2}



30 x 60 cm¹

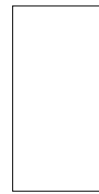

30 x 60 cm¹



30 x 60 cm¹

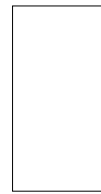

Nennmaß - cm/in	30 x 30 / 12 x 12		10 x 60 / 4 x 24		30 x 60 / 12 x 24		30 x 60 / 12 x 24	
	Herstellmaß	297 x 297 x 10,5 mm	297 x 297 x 10,5 mm	97 x 597 x 10,5 mm	147 x 597 x 10,5 mm	297 x 597 x 10,5 mm	297 x 597 x 10,5 mm	297 x 597 x 10,5 mm
Oberfläche	eben, matt							
m ² - Stück	11,111	11,111	16,667	11,111	5,556	5,556	5,556	5,556
m ² - kg	23,144	23,144	23,667	23,222	23,224	23,224	23,224	23,224
Paket - Stück	11	11	15	11	6	6	6	6
Paket - m ²	0,990	0,990	0,900	0,990	1,080	1,080	1,080	1,080
Paket - kg	22,913	22,913	21,300	22,990	25,080	25,080	25,080	25,080
Palette - m ²	47,520	47,520	36,000	39,600	43,197	43,197	43,197	43,197
Palette - kg	1.099,824	1.099,824	852,012	919,600	1.003,200	1.003,200	1.003,200	1.003,200
Produktnorm	Bla							
Trittsicherheit	R10/A	R11/B	R10/A	R10/A	R10/A	R11/B	R11/B	R12/C
Belastung	3		2	2	2	2	2	2
	430292H	430304H	<i>430316H</i>	<i>430328H</i>	430340H	430352H	430364H	
anthrazit <input checked="" type="checkbox"/>	Preisgr. A109 (m ²)	Preisgr. A109 (m ²)	Preisgr. A199 (m ²)	Preisgr. A199 (m ²)	Preisgr. A121 (m ²)	Preisgr. A121 (m ²)	Preisgr. A154 (m ²)	
	430293H	430305H	<i>430317H</i>	<i>430329H</i>	430341H	430353H	430365H	
basalt <input checked="" type="checkbox"/>	Preisgr. A109 (m ²)	Preisgr. A109 (m ²)	Preisgr. A199 (m ²)	Preisgr. A199 (m ²)	Preisgr. A121 (m ²)	Preisgr. A121 (m ²)	Preisgr. A154 (m ²)	
	430294H	430306H	<i>430318H</i>	<i>430330H</i>	430342H	430354H	430366H	
kiesel <input checked="" type="checkbox"/>	Preisgr. A109 (m ²)	Preisgr. A109 (m ²)	Preisgr. A199 (m ²)	Preisgr. A199 (m ²)	Preisgr. A121 (m ²)	Preisgr. A121 (m ²)	Preisgr. A154 (m ²)	
	430295H	430307H	<i>430319H</i>	<i>430331H</i>	430343H	430355H	430367H	
stein <input checked="" type="checkbox"/>	Preisgr. A109 (m ²)	Preisgr. A109 (m ²)	Preisgr. A199 (m ²)	Preisgr. A199 (m ²)	Preisgr. A121 (m ²)	Preisgr. A121 (m ²)	Preisgr. A154 (m ²)	
	430296H	430308H	<i>430320H</i>	<i>430332H</i>	430344H	430356H	430368H	
sandweiß <input checked="" type="checkbox"/>	Preisgr. A109 (m ²)	Preisgr. A109 (m ²)	Preisgr. A199 (m ²)	Preisgr. A199 (m ²)	Preisgr. A121 (m ²)	Preisgr. A121 (m ²)	Preisgr. A154 (m ²)	
	430297H	430309H	<i>430321H</i>	<i>430333H</i>	430345H	430357H	430369H	
sandgrau <input checked="" type="checkbox"/>	Preisgr. A109 (m ²)	Preisgr. A109 (m ²)	Preisgr. A199 (m ²)	Preisgr. A199 (m ²)	Preisgr. A121 (m ²)	Preisgr. A121 (m ²)	Preisgr. A154 (m ²)	
	430298H	430310H	<i>430322H</i>	<i>430334H</i>	430346H	430358H	430370H	
sand <input checked="" type="checkbox"/>	Preisgr. A109 (m ²)	Preisgr. A109 (m ²)	Preisgr. A199 (m ²)	Preisgr. A199 (m ²)	Preisgr. A121 (m ²)	Preisgr. A121 (m ²)	Preisgr. A154 (m ²)	
	430299H	430311H	<i>430323H</i>	<i>430335H</i>	430347H	430359H	430371H	
muskat <input checked="" type="checkbox"/>	Preisgr. A109 (m ²)	Preisgr. A109 (m ²)	Preisgr. A199 (m ²)	Preisgr. A199 (m ²)	Preisgr. A121 (m ²)	Preisgr. A121 (m ²)	Preisgr. A154 (m ²)	
	430300H	430312H	<i>430324H</i>	<i>430336H</i>	430348H	430360H	430372H	
platin <input checked="" type="checkbox"/>	Preisgr. A109 (m ²)	Preisgr. A109 (m ²)	Preisgr. A199 (m ²)	Preisgr. A199 (m ²)	Preisgr. A121 (m ²)	Preisgr. A121 (m ²)	Preisgr. A154 (m ²)	
	430301H	430313H	<i>430325H</i>	<i>430337H</i>	430349H	430361H	430373H	
sandbeige <input checked="" type="checkbox"/>	Preisgr. A109 (m ²)	Preisgr. A109 (m ²)	Preisgr. A199 (m ²)	Preisgr. A199 (m ²)	Preisgr. A121 (m ²)	Preisgr. A121 (m ²)	Preisgr. A154 (m ²)	
	430302H	430314H	<i>430326H</i>	<i>430338H</i>	430350H	430362H	430374H	
ziegel <input checked="" type="checkbox"/>	Preisgr. A109 (m ²)	Preisgr. A109 (m ²)	Preisgr. A199 (m ²)	Preisgr. A199 (m ²)	Preisgr. A121 (m ²)	Preisgr. A121 (m ²)	Preisgr. A154 (m ²)	
	430303H	430315H	<i>430327H</i>	<i>430339H</i>	430351H	430363H	430375H	
lehm <input checked="" type="checkbox"/>	Preisgr. A109 (m ²)	Preisgr. A109 (m ²)	Preisgr. A199 (m ²)	Preisgr. A199 (m ²)	Preisgr. A121 (m ²)	Preisgr. A121 (m ²)	Preisgr. A154 (m ²)	



Bodenfliesen

60 x 60 cm¹

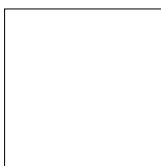

60 x 60 cm^{2/3/5}



60 x 60 cm¹

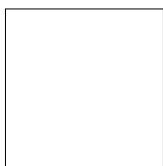

60 x 60 cm¹



60 x 120 cm^{1/4/6}



60 x 120 cm^{1/4/6}

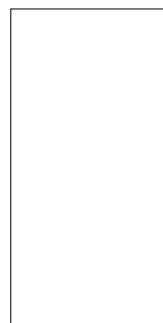

	überstark		Grid				
	60 x 60 / 24 x 24	60 x 60 / 24 x 24	60 x 60 / 24 x 24	60 x 60 / 24 x 24	60 x 120 / 24 x 48	60 x 120 / 24 x 48	Nennmaß - cm/in
	597 x 597 x 10,5 mm	600 x 600 x 14 mm	597 x 597 x 10,5 mm	597 x 597 x 10,5 mm	597 x 1197 x 10,5 mm	597 x 1197 x 10,5 mm	Herstellmaß
	eben, matt	eben, matt	eben, matt	profiliert, matt	eben, matt	eben, matt	Oberfläche
	2,778	2,778	2,778	2,778	1,389	1,389	m ² - Stück
	23,769	31,669	23,769	23,769	24,672	24,672	m ² - kg
	3	2	3	3	2	2	Paket - Stück
	1,080	0,720	1,080	1,080	1,440	1,440	Paket - m ²
	25,668	22,800	25,668	25,668	35,526	35,526	Paket - kg
	38,880	30,238	38,880	38,880	43,197	43,197	Palette - m ²
	924,048	957,600	924,048	924,048	1.065,780	1.065,780	Palette - kg
	Bla	Bla	Bla	Bla	Bla	Bla	Produktnorm
	R10/A	R10	R11/B	R12V4	R10/A	R11/B	Trittsicherheit
	3	4	3	3	2	2	Belastung
	430380H		430214H	430392H	430398H	430410H	anthrazit <input type="checkbox"/> V2
	Preisgr. A136 (m ²)		Preisgr. A136 (m ²)	Preisgr. A166 (m ²)	Preisgr. A154 (m ²)	Preisgr. A154 (m ²)	
	430381H		430215H	430393H	430399H	430411H	basalt <input type="checkbox"/> V2
	Preisgr. A136 (m ²)		Preisgr. A136 (m ²)	Preisgr. A166 (m ²)	Preisgr. A154 (m ²)	Preisgr. A154 (m ²)	
	430382H	430200H	430216H	430394H	430400H	430412H	kiesel <input type="checkbox"/> V2
	Preisgr. A136 (m ²)		Preisgr. A136 (m ²)	Preisgr. A166 (m ²)	Preisgr. A154 (m ²)	Preisgr. A154 (m ²)	
	430383H				430401H	430413H	stein <input type="checkbox"/> V2
	Preisgr. A136 (m ²)				Preisgr. A154 (m ²)	Preisgr. A154 (m ²)	
	430384H	430201H			430402H	430414H	sandweiß <input type="checkbox"/> V2
	Preisgr. A136 (m ²)				Preisgr. A154 (m ²)	Preisgr. A154 (m ²)	
	430385H	430202H	430217H	430395H	430403H	430415H	sandgrau <input type="checkbox"/> V2
	Preisgr. A136 (m ²)		Preisgr. A136 (m ²)	Preisgr. A166 (m ²)	Preisgr. A154 (m ²)	Preisgr. A154 (m ²)	
	430386H		430218H	430396H	430404H	430416H	sand <input type="checkbox"/> V2
	Preisgr. A136 (m ²)		Preisgr. A136 (m ²)	Preisgr. A166 (m ²)	Preisgr. A154 (m ²)	Preisgr. A154 (m ²)	
	430387H				430405H	430417H	muskat <input type="checkbox"/> V2
	Preisgr. A136 (m ²)				Preisgr. A154 (m ²)	Preisgr. A154 (m ²)	
	430388H		435576H NEU	435577H NEU	430406H	430418H	platin <input type="checkbox"/> V2
	Preisgr. A136 (m ²)		Preisgr. A136 (m ²)	Preisgr. A166 (m ²)	Preisgr. A154 (m ²)	Preisgr. A154 (m ²)	
	430389H		430219H	430397H	430407H	430419H	sandbeige <input type="checkbox"/> V2
	Preisgr. A136 (m ²)		Preisgr. A136 (m ²)	Preisgr. A166 (m ²)	Preisgr. A154 (m ²)	Preisgr. A154 (m ²)	
	430390H				430408H	430420H	ziegel <input type="checkbox"/> V2
	Preisgr. A136 (m ²)				Preisgr. A154 (m ²)	Preisgr. A154 (m ²)	
	430391H				430409H	430421H	lehm <input type="checkbox"/> V2
	Preisgr. A136 (m ²)				Preisgr. A154 (m ²)	Preisgr. A154 (m ²)	

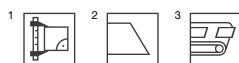

- ⁴ Hohes Gewicht! Karton bitte nur zu Zweit transportieren.
- ⁵ Preisstellungen werden objektspezifisch kalkuliert
- ⁶ Achtung: Sonderpalette, keine Rücknahme, kein Umtausch



Bodenfliese^{1/2/3}

Hohlkehlsocbel dekoriert⁴

Innenecke

Außenecke

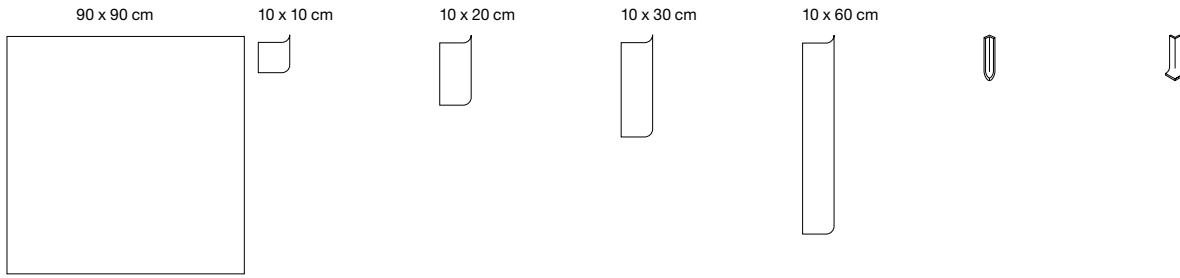

Nennmaß - cm/in	90 x 90 / 36 x 36	10 x 10 / 4 x 4	10 x 20 / 4 x 8	10 x 30 / 4 x 12	10 x 60 / 4 x 24		
Herstellmaß	895 x 895 x 11 mm	100 x 97 x 6,5 mm	102 x 197 x 9 mm	102 x 297 x 9 mm	102 x 597 x 9 mm	102 x 20 x 9 mm	102 x 35 x 9 mm
Oberfläche	eben, matt	eben, matt	eben, matt	eben, matt	eben, matt	eben, matt	eben, matt
m ² /m - Stück	1,234/m ²	10,000/m	5,000/m	3,333/m	1,667/m		
m ² /m.St. - kg	24,691/m ²	1,500/m	2,000/m	1,999/m	2,000/m	0,080/Stück	0,080/Stück
Paket - Stück	2	40	20	16	16	18	12
Paket - m ² /m	1,620 m ²	4,000 m	4,000 m	4,800 m	9,598 m		
Paket - kg	40,018	6,000	8,000	9,600	19,200	1,440	0,960
Palette - m ²	48,622						
Palette - kg	1.200,540						
Produktnorm	Bla	Bla	Bla	Bla	Bla	Bla	Bla
Trittsicherheit	R10/A	R10/B	R10/A	R10/A	R10/A		
Belastung	3						
anthrazit <input type="checkbox"/>	430422 Preisgr. A181 (m ²)	430564H Preisgr. A411 (St.)	430428H Preisgr. A419 (St.)	430440H Preisgr. A425 (St.)	430452H Preisgr. A445 (St.)	430480H Preisgr. A418 (St.)	430492H Preisgr. A418 (St.)
basalt <input type="checkbox"/>	430423 Preisgr. A181 (m ²)	430565H Preisgr. A411 (St.)	430429H Preisgr. A419 (St.)	430441H Preisgr. A425 (St.)	430453H Preisgr. A445 (St.)	430481H Preisgr. A418 (St.)	430493H Preisgr. A418 (St.)
kiesel <input type="checkbox"/>	430424 Preisgr. A181 (m ²)	430566H Preisgr. A411 (St.)	430430H Preisgr. A419 (St.)	430442H Preisgr. A425 (St.)	430454H Preisgr. A445 (St.)	430482H Preisgr. A418 (St.)	430494H Preisgr. A418 (St.)
stein <input type="checkbox"/>		430567H Preisgr. A411 (St.)	430431H Preisgr. A419 (St.)	430443H Preisgr. A425 (St.)	430455H Preisgr. A445 (St.)	430483H Preisgr. A418 (St.)	430495H Preisgr. A418 (St.)
sandweiß <input type="checkbox"/>		430568H Preisgr. A411 (St.)	430432H Preisgr. A419 (St.)	430444H Preisgr. A425 (St.)	430456H Preisgr. A445 (St.)	430484H Preisgr. A418 (St.)	430496H Preisgr. A418 (St.)
sandgrau <input type="checkbox"/>	430425 Preisgr. A181 (m ²)	430569H Preisgr. A411 (St.)	430433H Preisgr. A419 (St.)	430445H Preisgr. A425 (St.)	430457H Preisgr. A445 (St.)	430485H Preisgr. A418 (St.)	430497H Preisgr. A418 (St.)
sand <input type="checkbox"/>	430426 Preisgr. A181 (m ²)	430570H Preisgr. A411 (St.)	430434H Preisgr. A419 (St.)	430446H Preisgr. A425 (St.)	430458H Preisgr. A445 (St.)	430486H Preisgr. A418 (St.)	430498H Preisgr. A418 (St.)
muskat <input type="checkbox"/>		430571H Preisgr. A411 (St.)	430435H Preisgr. A419 (St.)	430447H Preisgr. A425 (St.)	430459H Preisgr. A445 (St.)	430487H Preisgr. A418 (St.)	430499H Preisgr. A418 (St.)
platin <input type="checkbox"/>		430572H Preisgr. A411 (St.)	430436H Preisgr. A419 (St.)	430448H Preisgr. A425 (St.)	430460H Preisgr. A445 (St.)	430488H Preisgr. A418 (St.)	430500H Preisgr. A418 (St.)
sandbeige <input type="checkbox"/>	430427 Preisgr. A181 (m ²)	430573H Preisgr. A411 (St.)	430437H Preisgr. A419 (St.)	430449H Preisgr. A425 (St.)	430461H Preisgr. A445 (St.)	430489H Preisgr. A418 (St.)	430501H Preisgr. A418 (St.)
ziegel <input type="checkbox"/>		430574H Preisgr. A411 (St.)	430438H Preisgr. A419 (St.)	430450H Preisgr. A425 (St.)	430462H Preisgr. A445 (St.)	430490H Preisgr. A418 (St.)	430502H Preisgr. A418 (St.)
lehm <input type="checkbox"/>		430575H Preisgr. A411 (St.)	430439H Preisgr. A419 (St.)	430451H Preisgr. A425 (St.)	430463H Preisgr. A445 (St.)	430491H Preisgr. A418 (St.)	430503H Preisgr. A418 (St.)



² ohne Hytect-Veredelung; mit Protecta-Vergütung

³ Achtung: Sonderpalette, keine Rücknahme, kein Umtausch

⁴ Produktionsbedingte Farbabweichungen zum angrenzenden Belag bei liegender Verlegung sind nicht reklamationsfähig

Detailzeichnungen Hohlkehlsocbel/Innenecken/Außenecken siehe S. 536 ff.

Duschtassensystem^{1/2}

10 x 10 cm



10 x 10 cm



Läufer

Ecke

					10 x 10 / 4 x 4	10 x 10 / 4 x 4	Nennmaß - cm/in
					97 x 97 x 6,5 mm	97 x 97 x 6,5 mm	Herstellmaß
					eben, matt	eben, matt	Oberfläche
					10,000		m - Stück
					1,700/m	0,170/Stück	m/St. - kg
					16	4	Paket - Stück
					1,600		Paket - m
					2,720	0,680	Paket - kg
					Bla	Bla	Produktnorm
					R10/B	R10/B	Trittsicherheit
					<i>430064H</i>	<i>430070H</i>	anthrazit <input type="checkbox"/> V2
					<i>Preisgr. A445 (St.)</i>	<i>Preisgr. A475 (St.)</i>	
					<i>430065H</i>	<i>430071H</i>	basalt <input type="checkbox"/> V2
					<i>Preisgr. A445 (St.)</i>	<i>Preisgr. A475 (St.)</i>	
					<i>430066H</i>	<i>430072H</i>	kiesel <input type="checkbox"/> V2
					<i>Preisgr. A445 (St.)</i>	<i>Preisgr. A475 (St.)</i>	
					<i>430067H</i>	<i>430073H</i>	sandgrau <input type="checkbox"/> V2
					<i>Preisgr. A445 (St.)</i>	<i>Preisgr. A475 (St.)</i>	
					<i>430068H</i>	<i>430074H</i>	sand <input type="checkbox"/> V2
					<i>Preisgr. A445 (St.)</i>	<i>Preisgr. A475 (St.)</i>	
					<i>430069H</i>	<i>430075H</i>	sandbeige <input type="checkbox"/> V2
					<i>Preisgr. A445 (St.)</i>	<i>Preisgr. A475 (St.)</i>	



² Details siehe S. 534

Treppenfliesen mit Rillierung²

Treppenfliese mit Rillierung 1/2/4

Treppenfliese mit Schräge^{2/3}

Treppenfliese mit Schräge & Rillierung 2/3/4

Setzstufe^{2/3}

30 x 30 cm



30 x 60 cm¹

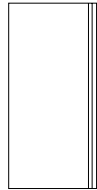

60 x 120 cm

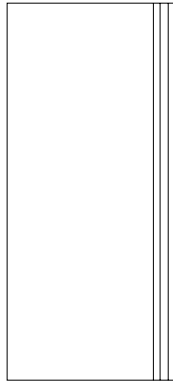

31 x 145 cm

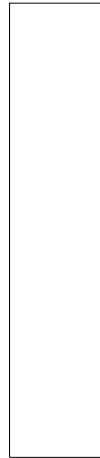

31 x 145 cm



28 x 145 cm

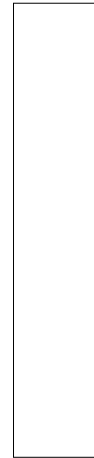

Nennmaß - cm/in	30 x 30 / 12 x 12	30 x 60 / 12 x 24	60 x 120 / 24 x 48	31 x 145 / 12 3/8 x 58	31 x 145 / 12 3/8 x 58	28 x 145 / 11 3/16 x 58
Herstellmaß	297 x 297 x 10,5 mm	297 x 597 x 10,5 mm	597 x 1197 x 10,5 mm	307 x 1447 x 10,5 mm	307 x 1447 x 10,5 mm	280 x 1447 x 10,5 mm
Oberfläche	eben, matt	eben, matt	eben, matt	eben, matt	eben, matt	eben, matt
m - Stück	3,333	1,667	0,833	0,690	0,690	0,690
m - kg	6,943	6,968	14,286	7,480	7,480	6,716
Paket - Stück	10	6	2	2	2	2
Paket - m	3,000	3,599	2,401	2,899	2,899	2,899
Paket - kg	20,830	25,080	34,300	21,682	21,682	19,466
Produktnorm	Bla	Bla	Bla	Ala	Ala	Ala
Trittsicherheit	R10/A	R10/A	R10/A	R10/A	R10/A	R10/A
Belastung	3	2	2	2	2	2
anthrazit <input type="checkbox"/>	430464H Preisgr. A449 (St.)	430504H Preisgr. A458 (St.)	430398H-TF ⁵ Preisgr. A593 (St.)	435685H ⁵ Preisgr. A560 (St.)	435685H-TF ⁵ Preisgr. A577 (St.)	435695H ⁵ Preisgr. A528 (St.)
basalt <input type="checkbox"/>	430465H Preisgr. A449 (St.)	430505H Preisgr. A458 (St.)	430399H-TF Preisgr. A593 (St.)	435686H Preisgr. A560 (St.)	435686H-TF Preisgr. A577 (St.)	435696H Preisgr. A528 (St.)
kiesel <input type="checkbox"/>	430466H Preisgr. A449 (St.)	430506H Preisgr. A458 (St.)	430400H-TF Preisgr. A593 (St.)	435687H Preisgr. A560 (St.)	435687H-TF Preisgr. A577 (St.)	435697H Preisgr. A528 (St.)
stein <input type="checkbox"/>	430467H Preisgr. A449 (St.)	430507H Preisgr. A458 (St.)	430401H-TF Preisgr. A593 (St.)	435688H Preisgr. A560 (St.)	435688H-TF Preisgr. A577 (St.)	435698H Preisgr. A528 (St.)
sandweiß <input type="checkbox"/>	430468H Preisgr. A449 (St.)	430508H Preisgr. A458 (St.)	430402H-TF Preisgr. A593 (St.)	435689H Preisgr. A560 (St.)	435689H-TF Preisgr. A577 (St.)	435699H Preisgr. A528 (St.)
sandgrau <input type="checkbox"/>	430469H Preisgr. A449 (St.)	430509H Preisgr. A458 (St.)	430403H-TF Preisgr. A593 (St.)	430476H Preisgr. A560 (St.)	430476H-TF Preisgr. A577 (St.)	430477H Preisgr. A528 (St.)
sand <input type="checkbox"/>	430470H Preisgr. A449 (St.)	430510H Preisgr. A458 (St.)	430404H-TF Preisgr. A593 (St.)	435690H Preisgr. A560 (St.)	435690H-TF Preisgr. A577 (St.)	435700H Preisgr. A528 (St.)
muskat <input type="checkbox"/>	430471H Preisgr. A449 (St.)	430511H Preisgr. A458 (St.)	430405H-TF Preisgr. A593 (St.)	435691H Preisgr. A560 (St.)	435691H-TF Preisgr. A577 (St.)	435701H Preisgr. A528 (St.)
platin <input type="checkbox"/>	430472H Preisgr. A449 (St.)	430512H Preisgr. A458 (St.)	430406H-TF Preisgr. A593 (St.)	435692H Preisgr. A560 (St.)	435692H-TF Preisgr. A577 (St.)	435702H Preisgr. A528 (St.)
sandbeige <input type="checkbox"/>	430473H Preisgr. A449 (St.)	430513H Preisgr. A458 (St.)	430407H-TF Preisgr. A593 (St.)	435693H Preisgr. A560 (St.)	435693H-TF Preisgr. A577 (St.)	435703H Preisgr. A528 (St.)
ziegel <input type="checkbox"/>	430474H Preisgr. A449 (St.)	430514H Preisgr. A458 (St.)	430408H-TF Preisgr. A593 (St.)	435694H Preisgr. A560 (St.)	435694H-TF Preisgr. A577 (St.)	435704H Preisgr. A528 (St.)
lehm <input type="checkbox"/>	430475H Preisgr. A449 (St.)	430515H Preisgr. A458 (St.)	430409H-TF ⁵ Preisgr. A593 (St.)	430212H ⁵ Preisgr. A560 (St.)	430212H-TF ⁵ Preisgr. A577 (St.)	430248H ⁵ Preisgr. A528 (St.)



³ Nur an den zwei kurzen Seiten rektifiziert. Längsseite kann nicht rektifiziert werden.

⁴ Details siehe S. 538

⁵ Produktionsbedingt kann es zu Nuancenabweichungen kommen.

Treppenkanten^{1/2/4}

Treppenkante mit Schräge^{2/3/4}

Sockel, gerundet¹

4 x 60 cm



7,2 x 60 cm



7,2 x 120 cm



7,2 x 145 cm



7 x 30 cm



7 x 60 cm



	4 x 60 / 1 5/8 x 24	7,2 x 60 / 2 7/8 x 24	7,2 x 120 / 2 7/8 x 48	7,2 x 145 / 2 7/8 x 58	7 x 30 / 2 13/16 x 12	7 x 60 / 2 13/16 x 24	Nennmaß - cm/in
	40 x 597 x 10,5 mm	72 x 597 x 10,5 mm	72 x 1197 x 10,5 mm	72 x 1447 x 10,5 mm	70 x 297 x 10,5 mm	70 x 597 x 10,5 mm	Herstellmaß
	eben, matt	eben, matt	eben, matt	eben, matt	eben, matt	eben, matt	Oberfläche
	1,667	1,667	0,833	0,690	3,333	1,667	m - Stück
	0,967	1,355	1,170	1,737	1,583	1,584	m - kg
	9	9	10	10	22	15	Paket - Stück
	5,399	15,003	12,005	14,493	6,600	8,998	Paket - m
	5,220	7,317	14,050	25,180	10,450	14,250	Paket - kg
	Bla	Bla	Bla	Ala	Bla	Bla	Produktnorm
	R10/A	R10/A	R10/A	R10/A			Trittsicherheit
	2	2	2	2			Belastung
	430516H Preisgr. A458 (St.)	430340H-TK Preisgr. A458 (St.)	430398H-TK ⁵ Preisgr. A511 (St.)	435685H-TK ⁵ Preisgr. A539 (St.)	430080H Preisgr. A419 (St.)	430528H Preisgr. A438 (St.)	anthrazit <input type="checkbox"/> V2
	430517H Preisgr. A458 (St.)	430341H-TK Preisgr. A458 (St.)	430399H-TK Preisgr. A511 (St.)	435686H-TK Preisgr. A539 (St.)	430081H Preisgr. A419 (St.)	430529H Preisgr. A438 (St.)	basalt <input type="checkbox"/> V2
	430518H Preisgr. A458 (St.)	430342H-TK Preisgr. A458 (St.)	430400H-TK Preisgr. A511 (St.)	435687H-TK Preisgr. A539 (St.)	430082H Preisgr. A419 (St.)	430530H Preisgr. A438 (St.)	kiesel <input type="checkbox"/> V2
	430519H Preisgr. A458 (St.)	430343H-TK Preisgr. A458 (St.)	430401H-TK Preisgr. A511 (St.)	435688H-TK Preisgr. A539 (St.)	430083H Preisgr. A419 (St.)	430531H Preisgr. A438 (St.)	stein <input type="checkbox"/> V2
	430520H Preisgr. A458 (St.)	430344H-TK Preisgr. A458 (St.)	430402H-TK Preisgr. A511 (St.)	435689H-TK Preisgr. A539 (St.)	430084H Preisgr. A419 (St.)	430532H Preisgr. A438 (St.)	sandweiß <input type="checkbox"/> V2
	430521H Preisgr. A458 (St.)	430345H-TK Preisgr. A458 (St.)	430403H-TK Preisgr. A511 (St.)	430476H-TK Preisgr. A539 (St.)	430085H Preisgr. A419 (St.)	430533H Preisgr. A438 (St.)	sandgrau <input type="checkbox"/> V2
	430522H Preisgr. A458 (St.)	430346H-TK Preisgr. A458 (St.)	430404H-TK Preisgr. A511 (St.)	435690H-TK Preisgr. A539 (St.)	430086H Preisgr. A419 (St.)	430534H Preisgr. A438 (St.)	sand <input type="checkbox"/> V2
	430523H Preisgr. A458 (St.)	430347H-TK Preisgr. A458 (St.)	430405H-TK Preisgr. A511 (St.)	435691H-TK Preisgr. A539 (St.)	430087H Preisgr. A419 (St.)	430535H Preisgr. A438 (St.)	muskat <input type="checkbox"/> V2
	430524H Preisgr. A458 (St.)	430348H-TK Preisgr. A458 (St.)	430406H-TK Preisgr. A511 (St.)	435692H-TK Preisgr. A539 (St.)	430088H Preisgr. A419 (St.)	430536H Preisgr. A438 (St.)	platin <input type="checkbox"/> V2
	430525H Preisgr. A458 (St.)	430349H-TK Preisgr. A458 (St.)	430407H-TK Preisgr. A511 (St.)	435693H-TK Preisgr. A539 (St.)	430089H Preisgr. A419 (St.)	430537H Preisgr. A438 (St.)	sandbeige <input type="checkbox"/> V2
	430526H Preisgr. A458 (St.)	430350H-TK Preisgr. A458 (St.)	430408H-TK Preisgr. A511 (St.)	435694H-TK Preisgr. A539 (St.)	430090H Preisgr. A419 (St.)	430538H Preisgr. A438 (St.)	ziegel <input type="checkbox"/> V2
	430527H Preisgr. A458 (St.)	430351H-TK Preisgr. A458 (St.)	430409H-TK ⁵ Preisgr. A511 (St.)	430212H-TK ⁵ Preisgr. A539 (St.)	430091H Preisgr. A419 (St.)	430539H Preisgr. A438 (St.)	lehm <input type="checkbox"/> V2

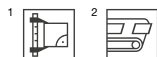

³ Nur an den zwei kurzen Seiten rektifiziert. Längsseite kann nicht rektifiziert werden.

⁴ Details siehe S. 538

⁵ Produktionsbedingt kann es zu Nuancenabweichungen kommen.



Blindenleitfliesen^{1/2/3}

30 x 30 cm

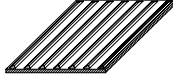

30 x 30 cm



Nennmaß - cm/in	30 x 30 / 12 x 12	30 x 30 / 12 x 12					
Herstellmaß	297 x 297 x 10,5 mm	297 x 297 x 10,5 mm					
Oberfläche	Rippenstruktur	Noppenstruktur					
m - Stück	3,333	3,333					
m - kg	7,999	7,999					
Paket - Stück	8	8					
Paket - m	2,400	2,400					
Paket - kg	19,200	19,200					
Produktnorm	Bla	Bla					
Trittsicherheit	R11	R11					
Belastung	3	3					
anthrazit	430304H-R Preisgr. A455 (St.)	430304H-N Preisgr. A539 (St.)					
platin	430312H-R Preisgr. A455 (St.)	430312H-N Preisgr. A539 (St.)					



¹ Analog den Anforderungen aus DIN 32984

² Andere Farbkombinationen auf Anfrage unter Berücksichtigung der Vorgaben zum Leuchtdichtekontrast aus DIN 32984

Rillenplatten 12,5 mm stark zur Fortführung des Beckenkopfsystems "Finnland II"^{1/2}

Flachrinnensystem^{1/2/3}

25 x 50 cm

25 x 25 cm

12,5 x 25 cm

50 x 25 cm

50 x 25 cm⁴

50 x 25 cm

50 x 25 cm⁴

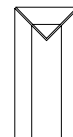
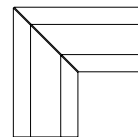
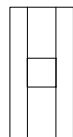
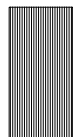

50 x 25 / 20 x 10	25 x 25 / 10 x 10	12,5 x 25 / 5 x 10	Flachrinne 50 x 25 / 20 x 10	Flachrinne mit Ablauf 110 / 110 mm 50 x 25 / 20 x 10	Flachrinne Gehrungspaar 50 x 25 cm	Flachrinne Endstück 50 x 25 cm ⁴	Nennmaß - cm/in
494 x 244 x 12,5 mm	244 x 244 x 12,5 mm	119 x 244 x 12,5 mm	494 x 244 x 14 mm	494 x 244 x 14 mm	(2x) 490 x 244 x 14 mm	494 x 244 x 14 mm	Herstellmaß
gerillt, matt	gerillt, matt	gerillt, matt	eben, matt	eben, matt	eben, matt	eben, matt	Oberfläche
2,000	4,000	8,000	2,000	2,000	3,800/Paar	2,500/Stück	m - Stück
3,550/Stück	1,775/Stück	0,888/Stück	2,500/Stück	2,300/Stück	2 Paar	5 Stück	St./Paar - kg
6 Stück	9 Stück	21 Stück	5 Stück	5 Stück			Paket - Stück/Paar
3,000	2,250	2,625	2,500	11,500	7,600	12,500	Paket - m
21,300	15,975	18,648	12,500	11,500	7,600	12,500	Paket - kg
Ala	Ala	Ala	Ala	Ala	Ala	Ala	Produktnorm
R11/C	R11/C	R11/C	R11/B	R11/B	R11/B	R11/B	Trittsicherheit
435601H	435613H	435625H	435637H	435649H	435661H	435673H	anthrazit <input type="checkbox"/> V2
Preisgr. A560 (St.)	Preisgr. A480 (St.)	Preisgr. A430 (St.)	Preisgr. A519 (St.)	Preisgr. A593 (St.)	Preisgr. A645 (Paar)	Preisgr. A593 (Paar)	
435602H	435614H	435626H	435638H	435650H	435662H	435674H	basalt <input type="checkbox"/> V2
Preisgr. A560 (St.)	Preisgr. A480 (St.)	Preisgr. A430 (St.)	Preisgr. A519 (St.)	Preisgr. A593 (St.)	Preisgr. A645 (Paar)	Preisgr. A593 (Paar)	
435603H	435615H	435627H	435639H	435651H	435663H	435675H	kiesel <input type="checkbox"/> V2
Preisgr. A560 (St.)	Preisgr. A480 (St.)	Preisgr. A430 (St.)	Preisgr. A519 (St.)	Preisgr. A593 (St.)	Preisgr. A645 (Paar)	Preisgr. A593 (Paar)	
435604H	435616H	435628H	435640H	435652H	435664H	435676H	stein <input type="checkbox"/> V2
Preisgr. A560 (St.)	Preisgr. A480 (St.)	Preisgr. A430 (St.)	Preisgr. A519 (St.)	Preisgr. A593 (St.)	Preisgr. A645 (Paar)	Preisgr. A593 (Paar)	
435605H	435617H	435629H	435641H	435653H	435665H	435677H	sandweiß <input type="checkbox"/> V2
Preisgr. A560 (St.)	Preisgr. A480 (St.)	Preisgr. A430 (St.)	Preisgr. A519 (St.)	Preisgr. A593 (St.)	Preisgr. A645 (Paar)	Preisgr. A593 (Paar)	
435606H	435618H	435630H	435642H	435654H	435666H	435678H	sandgrau <input type="checkbox"/> V2
Preisgr. A560 (St.)	Preisgr. A480 (St.)	Preisgr. A430 (St.)	Preisgr. A519 (St.)	Preisgr. A593 (St.)	Preisgr. A645 (Paar)	Preisgr. A593 (Paar)	
435607H	435619H	435631H	435643H	435655H	435667H	435679H	sand <input type="checkbox"/> V2
Preisgr. A560 (St.)	Preisgr. A480 (St.)	Preisgr. A430 (St.)	Preisgr. A519 (St.)	Preisgr. A593 (St.)	Preisgr. A645 (Paar)	Preisgr. A593 (Paar)	
435608H	435620H	435632H	435644H	435656H	435668H	435680H	muskat <input type="checkbox"/> V2
Preisgr. A560 (St.)	Preisgr. A480 (St.)	Preisgr. A430 (St.)	Preisgr. A519 (St.)	Preisgr. A593 (St.)	Preisgr. A645 (Paar)	Preisgr. A593 (Paar)	
435609H	435621H	435633H	435645H	435657H	435669H	435681H	platin <input type="checkbox"/> V2
Preisgr. A560 (St.)	Preisgr. A480 (St.)	Preisgr. A430 (St.)	Preisgr. A519 (St.)	Preisgr. A593 (St.)	Preisgr. A645 (Paar)	Preisgr. A593 (Paar)	
435610H	435622H	435634H	435646H	435658H	435670H	435682H	sandbeige <input type="checkbox"/> V2
Preisgr. A560 (St.)	Preisgr. A480 (St.)	Preisgr. A430 (St.)	Preisgr. A519 (St.)	Preisgr. A593 (St.)	Preisgr. A645 (Paar)	Preisgr. A593 (Paar)	
435611H	435623H	435635H	435647H	435659H	435671H	435683H	ziegel <input type="checkbox"/> V2
Preisgr. A560 (St.)	Preisgr. A480 (St.)	Preisgr. A430 (St.)	Preisgr. A519 (St.)	Preisgr. A593 (St.)	Preisgr. A645 (Paar)	Preisgr. A593 (Paar)	
435612H	435624H	435636H	435648H	435660H	435672H	435684H	lehm <input type="checkbox"/> V2
Preisgr. A560 (St.)	Preisgr. A480 (St.)	Preisgr. A430 (St.)	Preisgr. A519 (St.)	Preisgr. A593 (St.)	Preisgr. A645 (Paar)	Preisgr. A593 (Paar)	



¹ Kopfkante rektifiziert

² Auf Anfrage auch in 497 mm Länge erhältlich.

³ Mindestabnahmemenge 10 Stück. Unter 10 Stück muss der Preis individuell kalkuliert werden.

Weitere Details zum Beckenkopfsystem Finnland II / Flachrinnensystem im Lieferprogramm Pool+Spa.



Terrassenplatten^{1/2}

60 x 60 cm

60 x 60 cm

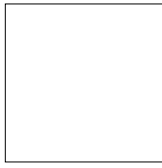

Flächendekor "Square"

Nennmaß - cm/in	60 x 60 / 24 x 24	60 x 60 / 24 x 24					
Herstellmaß	597 x 597 x 20 mm	597 x 597 x 20 mm					
Oberfläche	eben, matt	eben, matt					
m ² - Stück	2,778	2,778					
m ² - kg	45,273	45,273					
Paket - Stück	2	2					
Paket - m ²	0,720	0,720					
Paket - kg	32,594	32,594					
Palette - m ²	21,598	21,598					
Palette - kg	977,820	977,820					
Produktnorm	Bla	Bla					
Trittsicherheit	R11/B	R11/B					
Belastung	4	4					
anthrazit <input type="checkbox"/> V2	430093H Preisgr. A199 (m ²)						
basalt <input type="checkbox"/> V2	430094H Preisgr. A199 (m ²)						
basalt <input type="checkbox"/> V3		430115H Preisgr. A199 (m ²)					
kiesel <input type="checkbox"/> V2	430095H Preisgr. A199 (m ²)						
sandgrau <input type="checkbox"/> V2	430096H Preisgr. A199 (m ²)						
sandgrau <input type="checkbox"/> V3		430116H Preisgr. A199 (m ²)					
sand <input type="checkbox"/> V2	430097H Preisgr. A199 (m ²)						
sandbeige <input type="checkbox"/> V2	430098H Preisgr. A199 (m ²)						
sandbeige <input type="checkbox"/> V3		430117H Preisgr. A199 (m ²)					



² Hohes Gewicht! Karton bitte nur zu Zweit transportieren.

Formteile Terrassenplatten¹

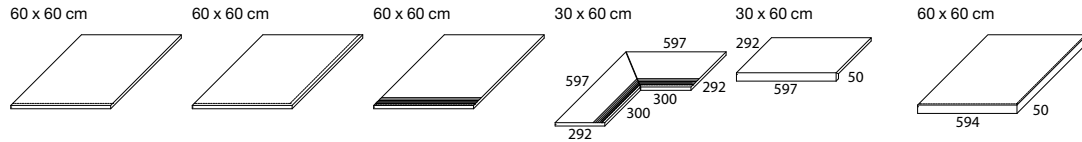

	<i>Terrassenplatte mit Rundung einseitig</i>	<i>Terrassenplatte mit Rundung über Eck</i>	<i>Terrassenplatte mit Rundung einseitig und Rillierung</i>	<i>Terrassenplatte mit Rundung einseitig und Rillierung als Ecklösung (2-teilig)</i>	<i>Terrassenplattenstufe mit Schenkel</i>	<i>Terrassenplattenstufe mit Schenkel als Ecklösung</i>	
	60 x 60 / 24 x 24	60 x 60 / 24 x 24	60 x 60 / 24 x 24	30 x 60 / 12 x 24	30 x 60 / 12 x 24	60 x 60 / 24 x 24	Nennmaß - cm/in
	597 x 597 x 20 mm	597 x 597 x 20 mm	597 x 597 x 20 mm	292 x 597 x 20 mm	292/50 x 597 x 20 mm	594/50 x 594 x 20 mm	Herstellmaß
	eben, matt	eben, matt	eben, matt	eben, matt	eben, matt	eben, matt	Oberfläche
	1,667	1,667	1,667	1,667	1,667		m - Stück
	27,167/m	27,167/m	27,167/m	16,297/Paar	15,868/m		m/Paar - kg
	1 Stück	1 Stück	1 Stück	1 Paar	1 Stück	1 Stück	Paket - Stück/Paar
	0,600	0,600	0,600				Paket - m
	16,297	16,297	16,297	16,297	9,519	19,027	Paket - kg
							Palette - m
	Bla	Bla	Bla	Bla	Bla	Bla	Palette - kg
	R11/B	R11/B	R11/B	R11/B	R11/B	R11/B	Produktnorm
	4	4	4	4	4	4	Trittsicherheit
	430093H-RE	430093H-RZ	430093H-RER	430093H-RERZ	430093H-SE	430093H-SZ	Belastung
	Preisgr. A672 (St.)	Preisgr. A731 (St.)	Preisgr. A689 (St.)	Preisgr. A792 (St.)	Preisgr. A689 (St.)	Preisgr. A784 (St.)	anthrazit



Weitere Ausführungen hinsichtlich Kantenausbildung und/oder Formaten auf Anfrage möglich.

Mindestbestellmenge: 10 Laufmeter pro Auftrag (Aufteilung auf mehrere Artikel möglich), kleinere Mengen nach gesonderter Preiskalkulation.







Spiel mit Bewegung und Transparenz

Die Serie Aruba ist puristisch, harmonisch und ideal für private Bäder. In warmweißen Farben und Sandtönen gibt es sie als Wandfliese und Dekorfliese Kentia mit Palmlätter-Motiven. Die Dekorfliesen können frei nach Wahl angeordnet werden und sind richtungslos verlegbar sowie im Riegelformat erhältlich. Das und ihr spezielles Fliesenbild gibt beim Verlegen alle optischen Freiheiten. Es macht zudem die filigrane Rhythmisierung des Fliesenbildes möglich und bringt die Bewegung der Blätter besonders zur Geltung. Die Bodenfliesen runden das Angebot ab, auch in der besonders repräsentativen Dimension 60 x 120 cm und im optisch ansprechenden Mosaik-Format. Durch die Hytect-Oberfläche ist die gesamte Serie sehr pflegeleicht, sie wirkt antibakteriell und sorgt für hygienische Sauberkeit.

Rendering

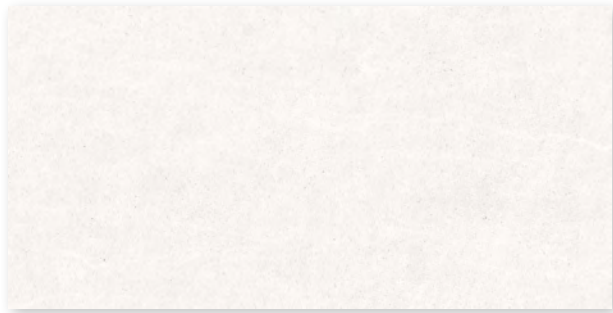

Wandfliese 30 x 60 cm, white, eben

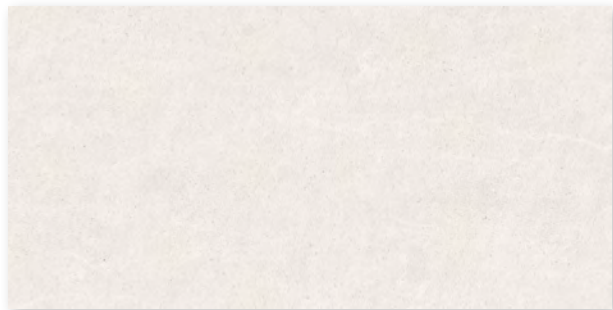

Wandfliese 30 x 60 cm, sand, eben

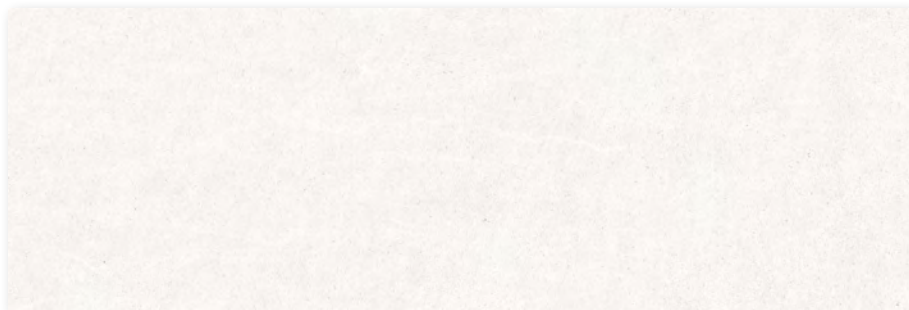

Wandfliese 30 x 90 cm, white, eben



Wandfliese 30 x 90 cm, sand, eben

Dekorationselemente



Dekorfliese Kentia 30 x 60 cm, sand white, eben



Dekorfliese Kentia 30 x 90 cm, sand white, eben

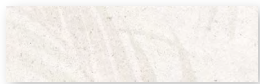

Riegelformat Kentia 7,5 x 25 cm, sand white, eben



pearl



mud



stone



graphite



Bodenfliese 30 x 60 cm, strukturiert, R9



Bodenfliese 60 x 60 cm, strukturiert, R9



Bodenfliese 60 x 120 cm, strukturiert, R9



Treppenfliese 30 x 60 cm (rilliert), strukturiert, R9



Sockel, gerundet 7 x 60 cm, strukturiert

Wandfliesen

Dekorationselemente²

30 x 60 cm



30 x 90 cm¹

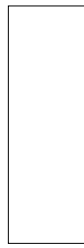

30 x 60 cm



30 x 90 cm¹



7,5 x 25 cm



	<i>Dekorfliese Kentia</i>		<i>Dekorfliese Kentia</i>		<i>Riegelformat Kentia</i>	
Nennmaß - cm/in	30 x 60 / 12 x 24	30 x 90 / 12 x 36	30 x 60 / 12 x 24	30 x 90 / 12 x 36	7,5 x 25 / 3 1/8 x 10	
Herstellmaß	297 x 597 x 6 mm	297 x 897 x 6 mm	297 x 597 x 6 mm	297 x 897 x 6 mm	72 x 247 x 6 mm	
Oberfläche	eben, seidenmatt	eben, seidenmatt	eben, seidenmatt	eben, seidenmatt	eben, seidenmatt	
m ² - Stück	5,556	3,704	5,556	3,704	53,333	
m ² - kg	10,279	10,400	10,279	10,400	9,813	
Paket - Stück	13	8	13	8	18	
Paket - m ²	2,340	2,160	2,340	2,160	0,338	
Paket - kg	24,050	22,464	24,050	22,464	3,123	
Palette - m ²	112,311	51,836	112,311	51,836	56,700	
Palette - kg	1.154,400	539,136	1.154,400	539,136	556,416	
Produktnorm	BIII	BIII	BIII	BIII	BIII	
white V2	203225H Preisgr. C68 (m ²)	323227H Preisgr. C134 (m ²)				
sand V2	203226H Preisgr. C68 (m ²)	323228H Preisgr. C134 (m ²)				
sand white V3			203229H Preisgr. C77 (m ²)	323230H Preisgr. C143 (m ²)	203333H Preisgr. C218 (m ²)	



² Abgabe der Dekorationselemente ausschließlich in vollen Kartons.

Bodenfliesen¹

30 x 60 cm



60 x 60 cm

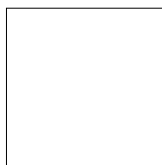

60 x 120 cm



Treppen- fliese^{1/2}

30 x 60 cm



Sockel, gerundet¹

7 x 60 cm¹



	30 x 60 / 12 x 24	60 x 60 / 24 x 24	60 x 120 / 24 x 48	30 x 60 / 12 x 24	7 x 60 / 2 13/16 x 24	Nennmaß - cm/in
	297 x 597 x 8 mm	597 x 597 x 8 mm	597 x 1197 x 8 mm	297 x 597 x 8 mm	70 x 597 x 8 mm	Herstellmaß
	strukturiert, matt	strukturiert, matt	strukturiert, matt	strukturiert, matt	strukturiert, matt	Oberfläche
	5,556/m ²	2,778/m ²	1,388/m ²	1,667/m	1,667/m	m ² /m - Stück
	17,413/m ²	18,001/m ²	17,489/m ²	5,224/m	1,219/m	m ² /m - kg
	6	4	2	6	15	Paket - Stück
	1,080/m ²	1,440/m ²	1,441/m ²	3,599/m	8,998/m	Paket - m ² /m
	18,804	25,920	25,200	18,804	10,969	Paket - kg
	43,197	43,197	36,023			Palette - m ²
	752,160	777,600	630,000			Palette - kg
	Alb	Alb	Alb	Alb	Alb	Produktnorm
	R9	R9	R9	R9		Trittsicherheit
	2	2	2	2		Belastung
	430834H	430838H	430842H	430846H	430850H	pearl <input type="checkbox"/> V3
	Preisgr. C122 (m ²)	Preisgr. C137 (m ²)	Preisgr. C161 (m ²)	Preisgr. C466 (St.)	Preisgr. C440 (St.)	mud <input type="checkbox"/> V3
	430835H	430839H	430843H	430847H	430851H	stone <input type="checkbox"/> V3
	Preisgr. C122 (m ²)	Preisgr. C137 (m ²)	Preisgr. C161 (m ²)	Preisgr. C466 (St.)	Preisgr. C440 (St.)	graphite <input type="checkbox"/> V3
	430836H	430840H	430844H	430848H	430797H	
	Preisgr. C122 (m ²)	Preisgr. C137 (m ²)	Preisgr. C161 (m ²)	Preisgr. C466 (St.)	Preisgr. C440 (St.)	
	430837H	430841H	430845H	430849H	430798H	
	Preisgr. C122 (m ²)	Preisgr. C137 (m ²)	Preisgr. C161 (m ²)	Preisgr. C466 (St.)	Preisgr. C440 (St.)	

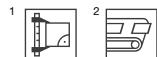



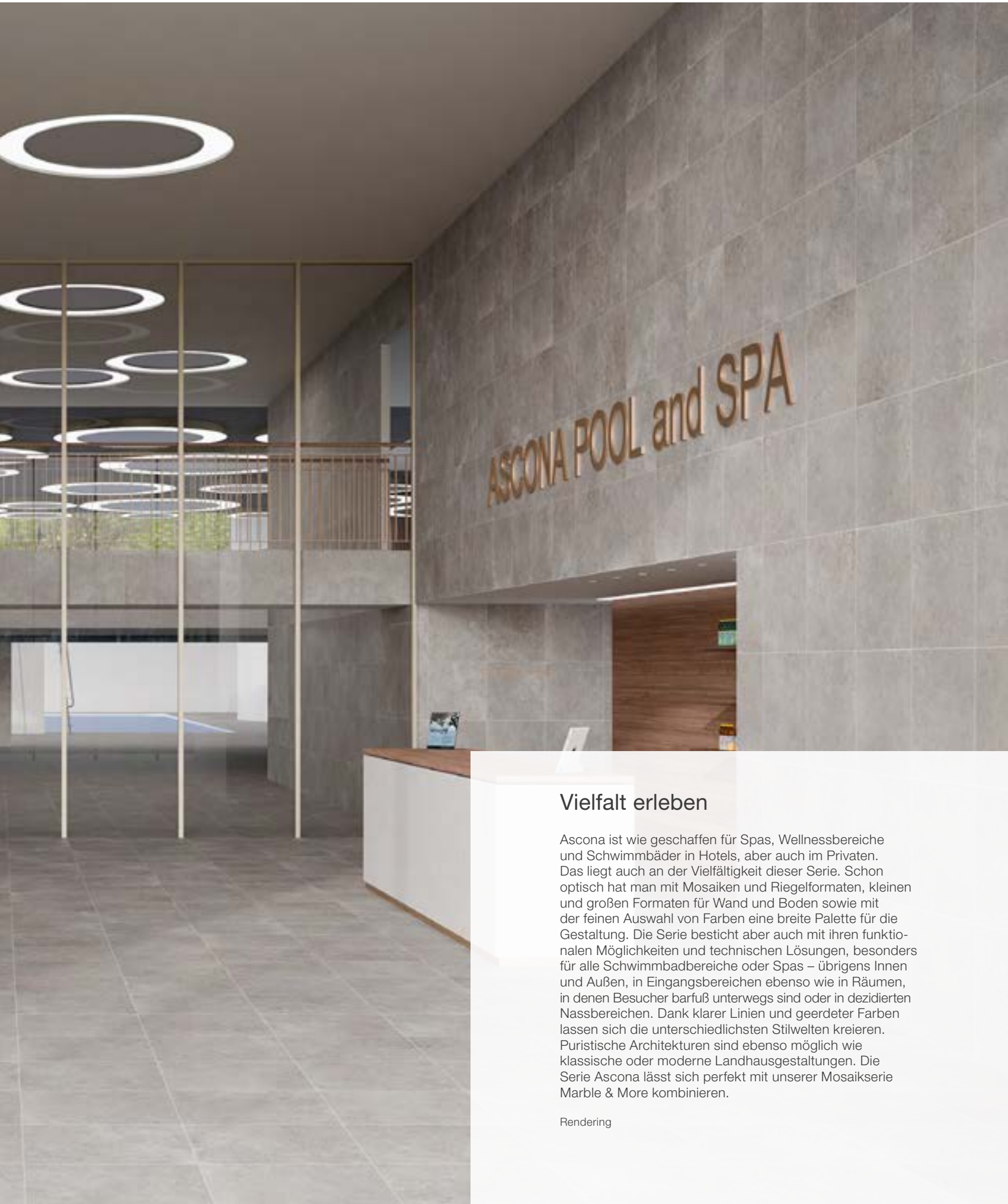

Vielfalt erleben

Ascona ist wie geschaffen für Spas, Wellnessbereiche und Schwimmbäder in Hotels, aber auch im Privaten. Das liegt auch an der Vielfältigkeit dieser Serie. Schon optisch hat man mit Mosaiken und Riegelformaten, kleinen und großen Formaten für Wand und Boden sowie mit der feinen Auswahl von Farben eine breite Palette für die Gestaltung. Die Serie besticht aber auch mit ihren funktionalen Möglichkeiten und technischen Lösungen, besonders für alle Schwimmbadbereiche oder Spas – übrigens Innen und Außen, in Eingangsbereichen ebenso wie in Räumen, in denen Besucher barfuß unterwegs sind oder in dezidierten Nassbereichen. Dank klarer Linien und geerdeter Farben lassen sich die unterschiedlichsten Stilwelten kreieren. Puristische Architekturen sind ebenso möglich wie klassische oder moderne Landhausgestaltungen. Die Serie Ascona lässt sich perfekt mit unserer Mosaikserie Marble & More kombinieren.

Rendering



R10/A R10/B R11/B R11/C



pearl



mud



stone



graphite

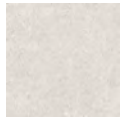

shell

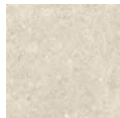

sand



Bodenfliese 15 x 15 cm, strukturiert, R10/B



Bodenfliese 25 x 50 cm, strukturiert, R11/B



Bodenfliese 30 x 60 cm, strukturiert, R10/A
Bodenfliese 30 x 60 cm, strukturiert, R11/B



Rasterprofilfliese 25 x 50 cm, reliefiert, R11/C



Schriftplatte 25 x 50 cm, strukturiert, R11/B

Mosaik 5 x 5 cm



Mosaikbogen 30 x 30 cm, pearl
strukturiert, R10/B



Mosaikbogen 30 x 30 cm, mud
strukturiert, R10/B



Mosaikbogen 30 x 30 cm, stone
strukturiert, R10/B



Mosaikbogen 30 x 30 cm, graphite
strukturiert, R10/B

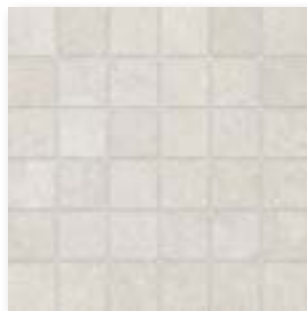

Mosaikbogen 30 x 30 cm, shell
strukturiert, R10/B



Mosaikbogen 30 x 30 cm, sand
strukturiert, R10/B



Rückseitig thermoplastisch verklebte Mosaik von Agrob Buchtal sind nicht nur im Trockenbereich, sondern auch bedenkenlos im Unterwasserbereich (z. B. Schwimmbecken/Whirlpool) sowie im dauernassbelasteten Bereich (z. B. Beckenumgänge/Duschen) einsetzbar.



Bodenfliese 60 x 60 cm, strukturiert, R10/A
 Bodenfliese 60 x 60 cm, strukturiert, R11/B



Hohlkehlsockel 10 x 50 cm, strukturiert, R10/A



Hohlkehlsockel 10 x 60 cm, strukturiert, R10/A



Sockel, geschnitten, 6 x 50 cm



Sockel, geschnitten, 6 x 60 cm



Treppenfliese mit Schräge und Rillierung, 31 x 145 cm, strukturiert, R10/A



Treppenfliese mit Schräge 31 x 145 cm, strukturiert, R10/A



Setzstufe 28 x 145 cm, strukturiert, R10/A

Rasterprofil



pearl



mud



stone

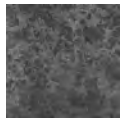

graphite

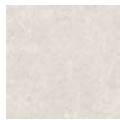

shell

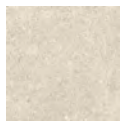

sand



Bodenfliese 12,5 x 12,5 cm, strukturiert, R11/B



Bodenfliese 12,5 x 25 cm, strukturiert, R11/B



Bodenfliese 25 x 25 cm, strukturiert, R11/B



Bodenfliese 25 x 50 cm, strukturiert, R11/B



Wandfliese 12,5 x 25 cm, strukturiert



Wandfliese 25 x 50 cm, strukturiert

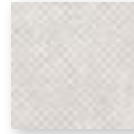

Rasterprofilfliese 12,5 x 12,5 cm, reliefiert, R11/C

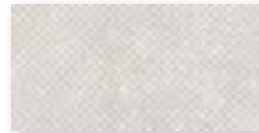

Rasterprofilfliese 12,5 x 25 cm, reliefiert, R11/C

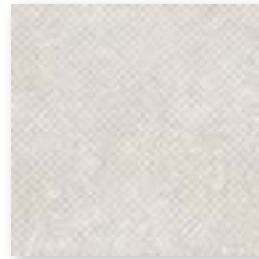

Rasterprofilfliese 25 x 25 cm, reliefiert, R11/C



Rasterprofilfliese 25 x 50 cm, reliefiert, R11/C



Rillenplatte 12,5 x 25 cm gerillt, R11/C



Rillenplatte 25 x 25 cm gerillt, R11/C



Rillenplatte 50 x 25 cm gerillt, R11/C



Hohlkehlssockel 10 x 25 cm, strukturiert, R10/A

Flachrinnensystem (Muldentiefe 5 mm)



Flachrinne, 50 x 25 cm strukturiert, R11/B



Flachrinne Gehrungspaar strukturiert, R11/B



Flachrinne mit Ablauf strukturiert, R11/B



Endstück strukturiert, R11/B

Details zum Flachrinnensystem siehe Lieferprogramm Pool + Spa.



pearl



mud



stone

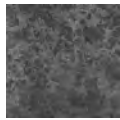

graphite



sand



Terrassenplatte 50 x 100 cm, strukturiert, R11/B

Bodenfliesen – 3 mm Fuge

Mosaik¹

5 x 5 cm



Bodenfliesen

15 x 15 cm



25 x 50 cm²

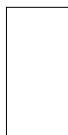

25 x 50 cm^{2/3}



30 x 60 cm²



30 x 60 cm²



Bogen: 297 x 297 mm

Rasterprofilfliese

	5 x 5 / 2 x 2	15 x 15 / 6 x 6	25 x 50 / 10 x 20	25 x 50 / 10 x 20	30 x 60 / 12 x 24	30 x 60 / 12 x 24	Nennmaß - cm/in
	47 x 47 x 6,5 mm	147 x 147 x 8 mm	247 x 497 x 8 mm	247 x 497 x 8 mm	297 x 597 x 8 mm	297 x 597 x 8 mm	Herstellmaß
	strukturiert, matt	strukturiert, matt	strukturiert, matt	reliefiert, matt	strukturiert, matt	strukturiert, matt	Oberfläche
	11 Bögen	44,444	8,000	8,000	5,556	5,556	m ² - Stück
	12,331	17,555	17,040	17,040	17,413	17,413	m ² - kg
	11	35	9	9	6	6	Paket - Stück
	1,000	0,788	1,125	1,125	1,080	1,080	Paket - m ²
	12,331	13,825	19,170	19,170	18,804	18,804	Paket - kg
	64,000	63,001	40,500	40,500	43,197	43,197	Palette - m ²
	789,184	1.106,000	690,120	690,120	752,160	752,160	Palette - kg
	Bla	Bla	Ala	Ala	Ala	Ala	Produktnorm
	R10/B	R10/B	R11/B	R11/C	R10/A	R11/B	Trittsicherheit
	1	2	2	2	2	2	Belastung
	430701H	430705H	430709H	<i>430713H</i>	430721H	430725H	pearl <input type="checkbox"/> V3
	Preisgr. A226 (m ²)	Preisgr. A154 (m ²)	Preisgr. A166 (m ²)	<i>Preisgr. A187 (m²)</i>	Preisgr. A124 (m ²)	Preisgr. A142 (m ²)	mud <input type="checkbox"/> V3
	430702H	430706H	430710H	<i>430714H</i>	430722H	430726H	stone <input type="checkbox"/> V3
	Preisgr. A226 (m ²)	Preisgr. A154 (m ²)	Preisgr. A166 (m ²)	<i>Preisgr. A187 (m²)</i>	Preisgr. A124 (m ²)	Preisgr. A142 (m ²)	graphite <input type="checkbox"/> V3
	430703H	430707H	430711H	<i>430715H</i>	430723H	430727H	shell <input type="checkbox"/> V3
	Preisgr. A226 (m ²)	Preisgr. A154 (m ²)	Preisgr. A166 (m ²)	<i>Preisgr. A187 (m²)</i>	Preisgr. A124 (m ²)	Preisgr. A142 (m ²)	sand <input type="checkbox"/> V3
	430704H	430708H	430712H	<i>430716H</i>	430724H	430728H	
	Preisgr. A226 (m ²)	Preisgr. A154 (m ²)	Preisgr. A166 (m ²)	<i>Preisgr. A187 (m²)</i>	Preisgr. A124 (m ²)	Preisgr. A142 (m ²)	
	431501H	431503H	431505H	<i>431507H</i>	431509H	431511H	
	Preisgr. A226 (m ²)	Preisgr. A154 (m ²)	Preisgr. A166 (m ²)	<i>Preisgr. A187 (m²)</i>	Preisgr. A124 (m ²)	Preisgr. A142 (m ²)	
	431502H	431504H	431506H	<i>431508H</i>	431510H	431512H	
	Preisgr. A226 (m ²)	Preisgr. A154 (m ²)	Preisgr. A166 (m ²)	<i>Preisgr. A187 (m²)</i>	Preisgr. A124 (m ²)	Preisgr. A142 (m ²)	

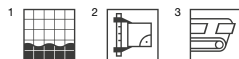

Bodenfliesen – 3 mm Fuge

Bodenfliesen¹

Treppenfliese mit Schräge und Rillierung^{2/3/4}

Treppenfliese mit Schräge^{2/3/4}

Setzstufe^{2/3/4}

60 x 60 cm

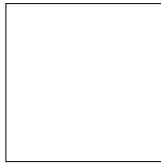

60 x 60 cm

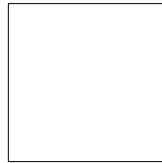

31 x 145 cm

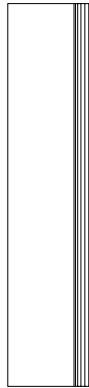

31 x 145 cm



28 x 145 cm



Nennmaß - cm/in	60 x 60 / 24 x 24	60 x 60 / 24 x 24	31 x 145 / 12 3/8 x 58	31 x 145 / 12 3/8 x 58	28 x 145 / 11 3/16 x 58		
Herstellmaß	597 x 597 x 8 mm	597 x 597 x 8 mm	307 x 1447 x 10,5 mm	307 x 1447 x 10,5 mm	280 x 1447 x 10,5 mm		
Oberfläche	strukturiert, matt	strukturiert, matt	strukturiert, matt	strukturiert, matt	strukturiert, matt		
m ² /m - Stück	2,778/m ²	2,778/m ²	0,690/m	0,690/m	0,690/m		
m ² /m - kg	18,001/m ²	18,001/m ²	7,480/m	7,480/m	6,716/m		
Paket - Stück	4	4	2	2	2		
Paket - m ² /m	1,440 m ²	1,440 m ²	2,899 m	2,899 m	2,899 m		
Paket - kg	25,920	25,920	21,682	21,682	19,466		
Palette - m ²	43,197	43,197					
Palette - kg	777,600	777,600					
Produktnorm	Ala	Ala	Ala	Ala	Ala		
Trittsicherheit	R10/A	R11/B	R10/A	R10/A	R10/A		
Belastung	2	2	2	2	2		
pearl <input type="checkbox"/> V3	430729H Preisgr. A136 (m ²)	430733H Preisgr. A151 (m ²)	<i>431576H-TF</i> <i>Preisgr. A577 (St.)</i>	<i>431576H</i> <i>Preisgr. A560 (St.)</i>	<i>431582H</i> <i>Preisgr. A528 (St.)</i>		
mud <input type="checkbox"/> V3	430730H Preisgr. A136 (m ²)	430734H Preisgr. A151 (m ²)	<i>431577H-TF</i> <i>Preisgr. A577 (St.)</i>	<i>431577H</i> <i>Preisgr. A560 (St.)</i>	<i>431583H</i> <i>Preisgr. A528 (St.)</i>		
stone <input type="checkbox"/> V3	430731H Preisgr. A136 (m ²)	430735H Preisgr. A151 (m ²)	<i>431578H-TF</i> <i>Preisgr. A577 (St.)</i>	<i>431578H</i> <i>Preisgr. A560 (St.)</i>	<i>431584H</i> <i>Preisgr. A528 (St.)</i>		
graphite <input type="checkbox"/> V3	430732H Preisgr. A136 (m ²)	430736H Preisgr. A151 (m ²)	<i>431579H-TF</i> <i>Preisgr. A577 (St.)</i>	<i>431579H</i> <i>Preisgr. A560 (St.)</i>	<i>431585H</i> <i>Preisgr. A528 (St.)</i>		
shell <input type="checkbox"/> V3	431513H Preisgr. A136 (m ²)	431515H Preisgr. A151 (m ²)	<i>431580H-TF</i> <i>Preisgr. A577 (St.)</i>	<i>431580H</i> <i>Preisgr. A560 (St.)</i>	<i>431586H</i> <i>Preisgr. A528 (St.)</i>		
sand <input type="checkbox"/> V3	431514H Preisgr. A136 (m ²)	431516H Preisgr. A151 (m ²)	<i>431581H-TF</i> <i>Preisgr. A577 (St.)</i>	<i>431581H</i> <i>Preisgr. A560 (St.)</i>	<i>431587H</i> <i>Preisgr. A528 (St.)</i>		

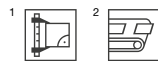

³ Nur an den zwei kurzen Seiten rektifiziert. Längsseite kann nicht rektifiziert werden.
⁴ Details siehe S. 538. Weitere Lösungen zu Treppenausführungen siehe Serie Area Pro

Hohlkehlsoclel dekoriert^{1/2/7} Sockel, geschnitten¹

Schriftplatte^{1/2/3}

10 x 50 cm



10 x 60 cm



6 x 50 cm



6 x 60 cm



25 x 50 cm

WT. 1.35m



Schrifthöhe 7 cm

	10 x 50 / 4 x 20	10 x 60 / 4 x 24	6 x 50 / 2 3/8 x 20	6 x 60 / 2 3/8 x 24	25 x 50 / 10 x 20	Nennmaß - cm/in
	100 x 497/35 x 9 mm	100 x 597/35 x 9 mm	60 x 497 x 8 mm	60 x 597 x 8 mm	247 x 497 x 8 mm	Herstellmaß
	strukturiert, matt	strukturiert, matt	strukturiert, matt	strukturiert, matt	strukturiert, matt	Oberfläche
	2,000	1,667	2,000	1,667	2,000	m - Stück
	2,000/m	2,000/m	1,098/m	1,100/m	2,130/Stück	m/St. - kg
	20	20	30	34		Paket - Stück
	10,000	11,998	15,000	20,396		Paket - m
	20,000	24,000	16,470	22,440		Paket - kg
						Palette - m ²
						Palette - kg
	Alb	Alb	Ala	Ala	Ala	Produktnorm
	R10/A	R10/A			R11/B	Trittsicherheit
					2	Belastung
	430741H ⁶	430737H ⁶	430984H	430988H	430717H	pearl <input type="checkbox"/> V3
	Preisgr. A441 (St.)	Preisgr. A445 (St.)	Preisgr. A434 (St.)	Preisgr. A434 (St.)	Preisgr. A668 (St.)	
	430742H ⁵	430738H ⁵	430985H	430989H	430718H	mud <input type="checkbox"/> V3
	Preisgr. A441 (St.)	Preisgr. A445 (St.)	Preisgr. A434 (St.)	Preisgr. A434 (St.)	Preisgr. A668 (St.)	
	430743H ⁶	430739H ⁶	430986H	430990H	430719H	stone <input type="checkbox"/> V3
	Preisgr. A441 (St.)	Preisgr. A445 (St.)	Preisgr. A434 (St.)	Preisgr. A434 (St.)	Preisgr. A668 (St.)	
	430744H ⁴	430740H ⁴	430987H	430991H	430720H	graphite <input type="checkbox"/> V3
	Preisgr. A441 (St.)	Preisgr. A445 (St.)	Preisgr. A434 (St.)	Preisgr. A434 (St.)	Preisgr. A668 (St.)	
	431523H ⁶	431525H ⁶	431527H	431529H	431531H	shell <input type="checkbox"/> V3
	Preisgr. A441 (St.)	Preisgr. A445 (St.)	Preisgr. A434 (St.)	Preisgr. A434 (St.)	Preisgr. A668 (St.)	
	431524H ⁶	431526H ⁶	431528H	431530H	431532H	sand <input type="checkbox"/> V3
	Preisgr. A441 (St.)	Preisgr. A445 (St.)	Preisgr. A434 (St.)	Preisgr. A434 (St.)	Preisgr. A668 (St.)	



¹ nur Ziffern / Buchstaben in der Farbe 91 (neutral 10 / aktivweiß) erhältlich.

⁴ Beanspruchungsgruppe: 2

⁵ Beanspruchungsgruppe: 3

⁶ Beanspruchungsgruppe: 4

⁷ Produktionsbedingte Farbabweichungen zum angrenzenden Belag bei liegender Verlegung sind nicht reklamationsfähig



Wand- und Bodenfliesen – 6 mm Fuge

Wandfliese Bodenfliesen



12,5 x 25 cm



12,5 x 12,5 cm²



12,5 x 12,5 cm^{1/2}



12,5 x 25 cm



12,5 x 25 cm¹



25 x 25 cm



25 x 25 cm¹



Rasterprofilfliese

Rasterprofilfliese

Rasterprofilfliese

Nennmaß - cm/in	12,5 x 25 / 5 x 10	12,5 x 12,5 / 5 x 5	12,5 x 12,5 / 5 x 5	12,5 x 25 / 5 x 10	12,5 x 25 / 5 x 10	25 x 25 / 10 x 10	25 x 25 / 10 x 10
Herstellmaß	119 x 244 x 8 mm	119 x 119 x 8 mm	119 x 119 x 8 mm	119 x 244 x 8 mm	119 x 244 x 8 mm	244 x 244 x 8 mm	244 x 244 x 8 mm
Oberfläche	strukturiert, matt	strukturiert, matt	reliefiert, matt	strukturiert, matt	reliefiert, matt	strukturiert, matt	reliefiert, matt
m ² - Stück	32,000	64,000	64,000	32,000	32,000	16,000	16,000
m ² - kg	15,680	15,360	15,360	15,680	15,680	16,960	16,960
Paket - Stück	33	66	66	33	33	14	14
Paket - m ²	1,031	1,031	1,031	1,031	1,031	0,875	0,875
Paket - kg	16,170	15,840	15,840	16,170	16,170	14,840	14,840
Palette - m ²	86,625	86,625	86,625	86,625	86,625	70,875	70,875
Palette - kg	1.358,280	1.330,560	1.330,560	1.358,280	1.358,280	1.202,040	1.202,040
Produktnorm	Ala	Ala	Ala	Ala	Ala	Ala	Ala
Trittsicherheit	-	R11/B	R11/C	R11/B	R11/C	R11/B	R11/C
Belastung	2	2	2	2	2	2	2
pearl <input type="checkbox"/>	430761H Preisgr. A127 (m ²)	430753H Preisgr. A166 (m ²)	<i>430757H</i> <i>Preisgr. A166 (m²)</i>	430763H Preisgr. A136 (m ²)	<i>430767H</i> <i>Preisgr. A148 (m²)</i>	430771H Preisgr. A175 (m ²)	<i>430775H</i> <i>Preisgr. A142 (m²)</i>
mud <input type="checkbox"/>		430754H Preisgr. A166 (m ²)	<i>430758H</i> <i>Preisgr. A166 (m²)</i>	430764H Preisgr. A136 (m ²)	<i>430768H</i> <i>Preisgr. A148 (m²)</i>	430772H Preisgr. A175 (m ²)	<i>430776H</i> <i>Preisgr. A142 (m²)</i>
stone <input type="checkbox"/>		430755H Preisgr. A166 (m ²)	<i>430759H</i> <i>Preisgr. A166 (m²)</i>	430765H Preisgr. A136 (m ²)	<i>430769H</i> <i>Preisgr. A148 (m²)</i>	430773H Preisgr. A175 (m ²)	<i>430777H</i> <i>Preisgr. A142 (m²)</i>
graphite <input type="checkbox"/>	430762H Preisgr. A127 (m ²)	430756H Preisgr. A166 (m ²)	<i>430760H</i> <i>Preisgr. A166 (m²)</i>	430766H Preisgr. A136 (m ²)	<i>430770H</i> <i>Preisgr. A148 (m²)</i>	430774H Preisgr. A175 (m ²)	<i>430778H</i> <i>Preisgr. A142 (m²)</i>
shell <input type="checkbox"/>	431533H Preisgr. A127 (m ²)	431534H Preisgr. A166 (m ²)	<i>431536H</i> <i>Preisgr. A166 (m²)</i>	431538H Preisgr. A136 (m ²)	<i>431540H</i> <i>Preisgr. A148 (m²)</i>	431542H Preisgr. A175 (m ²)	<i>431544H</i> <i>Preisgr. A142 (m²)</i>
sand <input type="checkbox"/>		431535H Preisgr. A166 (m ²)	<i>431537H</i> <i>Preisgr. A166 (m²)</i>	431539H Preisgr. A136 (m ²)	<i>431541H</i> <i>Preisgr. A148 (m²)</i>	431543H Preisgr. A175 (m ²)	<i>431545H</i> <i>Preisgr. A142 (m²)</i>



² Lieferung als Doppelfliesen; müssen örtlich gebrochen werden.

Wandfliese² Bodenfliesen²

Rillenplatten 12,5 mm stark zur Fortführung des Beckenkopfsystems „Finnland II“^{1/3/4}

25 x 50 cm



25 x 50 cm



25 x 50 cm¹



50 x 25 cm

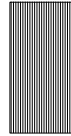

25 x 25 cm



12,5 x 25 cm



Rasterprofilfliese							
25 x 50 / 10 x 20	25 x 50 / 10 x 20	25 x 50 / 10 x 20		50 x 25 / 20 x 10	25 x 25 / 10 x 10	12,5 x 25 / 5 x 10	Nennmaß - cm/in
244 x 494 x 8 mm	244 x 494 x 8 mm	244 x 494 x 8 mm		494 x 244 x 12,5 mm	244 x 244 x 12,5 mm	119 x 244 x 12,5 mm	Herstellmaß - mm
strukturiert, matt	strukturiert, matt	reliefiert, matt		gerillt, matt	gerillt, matt	gerillt, matt	Oberfläche
8,000/m ²	8,000/m ²	8,000/m ²		2,000/m	4,000/m	8,000/m	m ² /m - Stück
17,040/m ²	17,040/m ²	17,040/m ²		3,550/Stück	1,775/Stück	0,888/Stück	m ² /St. - kg
9	9	9		6	9	21	Paket - Stück
1,125/m ²	1,125/m ²	1,125/m ²		3,000/m	2,250/m	2,625/m	Paket - m ² / m
19,170	19,170	19,170		21,300	15,975	18,648	Paket - kg
40,500	40,500	40,500					Palette - m ²
690,120	690,120	690,120					Palette - kg
Ala	Ala	Ala		Ala	Ala	Ala	Produktnorm
-	R11/B	R11/C		R11/C	R11/C	R11/C	Trittsicherheit
	2	2					Belastung
430779H	430781H	430785H		430789H	430793H	430802H	pearl <input type="checkbox"/>
Preisgr. A154 (m ²)	Preisgr. A166 (m ²)	Preisgr. A187 (m ²)		Preisgr. A560 (St.)	Preisgr. A480 (St.)	Preisgr. A430 (St.)	<input type="checkbox"/>
	430782H	430786H		430790H	430794H	430803H	mud <input type="checkbox"/>
	Preisgr. A166 (m ²)	Preisgr. A187 (m ²)		Preisgr. A560 (St.)	Preisgr. A480 (St.)	Preisgr. A430 (St.)	<input type="checkbox"/>
	430783H	430787H		430791H	430795H	430804H	stone <input type="checkbox"/>
	Preisgr. A166 (m ²)	Preisgr. A187 (m ²)		Preisgr. A560 (St.)	Preisgr. A480 (St.)	Preisgr. A430 (St.)	<input type="checkbox"/>
430780H	430784H	430788H		430792H	430796H	430805H	graphite <input type="checkbox"/>
Preisgr. A154 (m ²)	Preisgr. A166 (m ²)	Preisgr. A187 (m ²)		Preisgr. A560 (St.)	Preisgr. A480 (St.)	Preisgr. A430 (St.)	<input type="checkbox"/>
431546H	431547H	431549H		431551H	431553H	431555H	shell <input type="checkbox"/>
Preisgr. A154 (m ²)	Preisgr. A166 (m ²)	Preisgr. A187 (m ²)		Preisgr. A560 (St.)	Preisgr. A480 (St.)	Preisgr. A430 (St.)	<input type="checkbox"/>
	431548H	431550H		431552H	431554H	431556H	sand <input type="checkbox"/>
	Preisgr. A166 (m ²)	Preisgr. A187 (m ²)		Preisgr. A560 (St.)	Preisgr. A480 (St.)	Preisgr. A430 (St.)	<input type="checkbox"/>

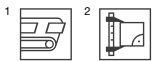

³ Kopfkante rektifiziert

⁴ Weitere Details zum Beckenkopfsystem Finnland II siehe Lieferprogramm Pool + Spa

Hohlkehlsocbel dekoriert^{1/2/10}

10 x 25 cm



Flachrinnensystem^{2/3/4/6}

50 x 25 cm

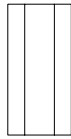

50 x 25 cm⁵

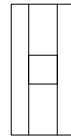

50 x 25 cm

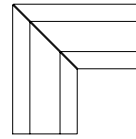

50 x 25 cm⁵

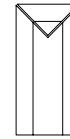

	10 x 25 / 4 x 10	Flachrinne 50 x 25 / 20 x 10	Flachrinne mit Ablauf 110 / 110 mm 50 x 25 / 20 x 10	Flachrinne Gehrungspaar 50 x 25 cm	Flachrinne Endstück 50 x 25 cm ⁵
Nennmaß - cm/in	10 x 25 / 4 x 10	50 x 25 / 20 x 10	50 x 25 / 20 x 10	50 x 25 / 20 x 10	50 x 25 cm ⁵
Herstellmaß - mm	100 x 244/35 x 9 mm	494 x 244 x 14 mm	494 x 244 x 14 mm	(2x) 490 x 244 x 14 mm	494 x 244 x 14 mm
Oberfläche	strukturiert, matt	strukturiert, matt	strukturiert, matt	strukturiert, matt	strukturiert, matt
m - Stück	4,000	2,000	2,300/Stück	3,800/Paar	2,500/Stück
St./Paar - kg	0,500/Stück	2,500/Stück	2,300/Stück	3,800/Paar	2,500/Stück
Paket - St./Paar	20 Stück	5 Stück	5 Stück	2 Paar	5 Stück
Paket - m		2,500			
Paket - kg	10,000	12,500	11,500	7,600	12,500
Palette - m ²					
Palette - kg					
Produktnorm	Alb	Ala	Ala	Ala	Ala
Trittsicherheit	R10/A	R11/B	R11/B	R11/B	R11/B
pearl <input type="checkbox"/>	430806H ⁹ Preisgr. A423 (St.)	430810H Preisgr. A519 (St.)	430814H Preisgr. A593 (St.)	430818H Preisgr. A645 (Paar)	430822H Preisgr. A593 (St.)
mud <input type="checkbox"/>	430807H ⁸ Preisgr. A423 (St.)	430811H Preisgr. A519 (St.)	430815H Preisgr. A593 (St.)	430819H Preisgr. A645 (Paar)	430823H Preisgr. A593 (St.)
stone <input type="checkbox"/>	430808H ⁹ Preisgr. A423 (St.)	430812H Preisgr. A519 (St.)	430816H Preisgr. A593 (St.)	430820H Preisgr. A645 (Paar)	430824H Preisgr. A593 (St.)
graphite <input type="checkbox"/>	430809H ⁷ Preisgr. A423 (St.)	430813H Preisgr. A519 (St.)	430817H Preisgr. A593 (St.)	430821H Preisgr. A645 (Paar)	430825H Preisgr. A593 (St.)
shell <input type="checkbox"/>	431557H ⁹ Preisgr. A423 (St.)	431559H Preisgr. A519 (St.)	431561H Preisgr. A593 (St.)	431563H Preisgr. A645 (Paar)	431565H Preisgr. A593 (St.)
sand <input type="checkbox"/>	431558H ⁹ Preisgr. A423 (St.)	431560H Preisgr. A519 (St.)	431562H Preisgr. A593 (St.)	431564H Preisgr. A645 (Paar)	431566H Preisgr. A593 (St.)



- ¹ Auf Anfrage auch in 497 mm Länge erhältlich
- ² Kopfkanten rektifiziert
- ³ Mindestabnahmemenge 10 Stück. Unter 10 Stück muss der Preis individuell kalkuliert werden.
- ⁴ Weitere Details zum Flachrinnensystem siehe Lieferprogramm Pool+Spa
- ⁵ Beanspruchungsgruppe: 2
- ⁶ Beanspruchungsgruppe: 3
- ⁷ Beanspruchungsgruppe: 4
- ⁸ Produktionsbedingte Farbabweichungen zum angrenzenden Belag bei liegender Verlegung sind nicht reklamationstauglich

Terrassenplatten – 3 mm Fuge¹

50 x 100 cm



						50 x 100 / 20 x 40	Nennmaß - cm/in
						497 x 997 x 20 mm	Herstellmaß - mm
						strukturiert, matt	Oberfläche
						2,000	m ² - Stück
						43,060	m ² - kg
						1	Paket - Stück
						0,500	Paket - m ²
						21,530	Paket - kg
						22,500	Palette - m ²
						968,850	Palette - kg
						Alla	Produktnorm
						R11/B	Trittsicherheit
						3	Belastung
						430826H	4
						Preisgr. A277 (m ²)	pearl V3
						430827H	4
						Preisgr. A277 (m ²)	mud V3
						430828H	4
						Preisgr. A277 (m ²)	stone V3
						430829H	4
						Preisgr. A277 (m ²)	graphite V3
						431567H	4
						Preisgr. A277 (m ²)	sand V3

Beanspruchungsgruppe







Modern und langlebig

Inspiziert von Schieferstrukturen entstand Basic Stone. Die keramische Oberfläche des 5 x 5 cm Mosaiks aus unglasiertem Feinsteinzeug mit Hytect-Oberfläche stellt das Thema Schiefer durch einen Reliefmix in Kombination mit dezenter Graphik modern und gleichzeitig langlebig dar. Feine Glanzpunkte aus Glimmer und dezente Farbkontraste unterstützen den steinigen Charakter der Oberfläche. Die Farbpalette orientiert sich an natürlichen Schieferfarben.

Rendering

Mosaik, 5 x 5 cm

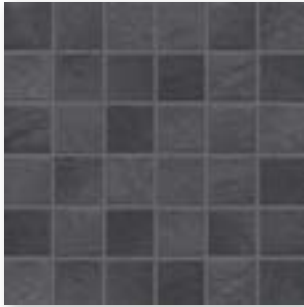

Mosaikbogen 30 x 30 cm, schwarz strukturiert, R10/B

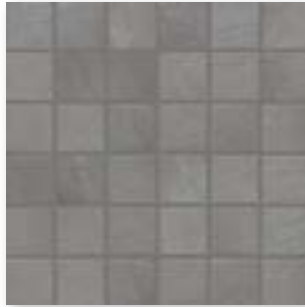

Mosaikbogen 30 x 30 cm, mittelgrau strukturiert, R10/B



Mosaikbogen 30 x 30 cm, hellgrau strukturiert, R10/B



Mosaikbogen 30 x 30 cm, schlamm strukturiert, R10/B



Mosaikbogen 30 x 30 cm, beige strukturiert, R10/B



Rückseitig thermoplastisch verklebte Mosaik von Agrob Buchtal sind nicht nur im Trockenbereich, sondern auch bedenkenlos im Unterwasserbereich (z. B. Schwimmbecken/Whirlpool) sowie im dauernassbelasteten Bereich (z. B. Beckenumgänge/Duschen) einsetzbar.

Mosaik

5 x 5 cm



Bogen: 297 x 297 mm



						5 x 5 / 2 x 2	Nennmaß - cm/in
						47 x 47 x 6,5 mm	Herstellmaß
						strukturiert, matt	Oberfläche
						11 Bögen	m ² - Stück
						12,331	m ² - kg
						11 Bögen	Paket - Stück
						1,000	Paket - m ²
						12,331	Paket - kg
						64,000	Palette - m ²
						789,184	Palette - kg
						Bla	Produktnorm
						R10/B	Trittsicherheit
						1	Belastung
						42200H-73	
						Preisgr. A211 (m ²)	schwarz <input type="checkbox"/> V2
						42201H-73	
						Preisgr. A211 (m ²)	mittelgrau <input type="checkbox"/> V2
						42202H-73	
						Preisgr. A211 (m ²)	hellgrau <input type="checkbox"/> V2
						42203H-73	
						Preisgr. A211 (m ²)	schlamm <input type="checkbox"/> V2
						42204H-73	
						Preisgr. A211 (m ²)	beige <input type="checkbox"/> V2

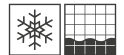





Zeitlos und schlicht

Die zeitlose Farbpalette und Formate von 5 x 5 cm bis 35 x 100 cm erlauben wirtschaftliche Lösungen in unterschiedlichen Bereichen. Die Serienergänzung Basis Pro erweitert das Angebot um ein Sortiment an Feinsteinzeug-Bodenfliesen in zeitgemäßem und langlebigem Design. Weiterer Pluspunkt: die hohen Trittsicherheiten von R10/A über R11/B bis R13V10. Duschassensysteme, Treppen-fliesen und Formteile ergänzen das Angebot.

Olympia-Stadion, Berlin, Deutschland / Architekt: von Gerkan, Marg und Partner, Berlin / Foto: FSMK Architektur + Industriefotograf



Basis 1

Steingut, glasiert



weiß, glänzend



weiß, matt



weiß matt und glänzend gewellt

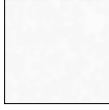

weiß glänzend gehämmert

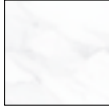

weiß marmoriert glänzend und matt



hellgrau marmoriert glänzend und matt



beige marmoriert glänzend und matt

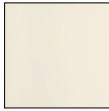

sandbeige glänzend und matt



elfenbein, glänzend



hellgrau, matt



hellbeige, matt



Listel Candy, 4,5 x 20 cm



Listel Candy, 1 x 20 cm

Basis 1+

Steingut, glasiert



weiß, glänzend



weiß, matt



weiß, glänzend gewellt

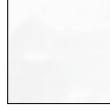

weiß, matt gewellt

Basis 2

Steinzeug, glasiert



weiß, matt



weiß, glänzend



grau, matt



hellgrau, matt



hellbeige, matt

Basis 3

Feinsteinzeug, unglasiert



titanit



anthrazit



mittelgrau

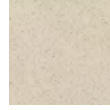

kreide



eben R10/A und R10/B



Softcorn 2 R11/B



Perlstic R12



Opticorn R12V4



Picstic R12V8

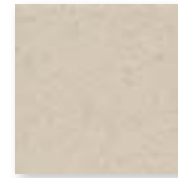

Geraut R13



Kombicorn R13V10

Basis 4

Steinzeugplatten, glasiert



weiß, glänzend



weiß, matt



grau transparent matt



lichtgrau, matt



lichtsahara matt



softazur glänzend



lichtblau glänzend



azurdunkel glänzend

Wandfliesen

15 x 15 cm



15 x 15 cm



15 x 30 cm



20 x 20 cm



20 x 25 cm



20 x 40 cm



25 x 33 cm



15 x 15 / 6 x 6	15 x 15 / 6 x 6	15 x 30 cm / 6 x 12	20 x 20 / 8 x 8	20 x 25 / 8 x 10	20 x 40 / 8 x 16	25 x 33 / 10 x 13	Nennmaß - cm/in
150 x 150 x 5,5 mm	147 x 147 x 5,5 mm	147 x 297 x 6,5 mm	197 x 197 x 6,0 mm	198 x 248 x 6,0 mm	197 x 397 x 7,5 mm	249 x 330 x 8,0 mm	Herstellmaß
eben	eben	eben	eben	eben	eben	eben	Oberfläche
44,000	44,000	22,222	25,000	20,000	12,500	12,121	m ² - Stück
9,504	9,416	10,622	10,800	10,260	12,975	12,969	m ² - kg
44	44	24	25	20	16	13	Paket - Stück
1,000	1,000	1,080	1,000	1,000	1,280	1,073	Paket - m ²
9,504	9,416	11,472	10,800	10,260	16,608	13,910	Paket - kg
105,000	105,000	91,801	96,000	92,000	92,160	80,439	Palette - m ²
997,920	988,680	975,120	1.036,800	943,920	1,195,776	1.043,250	Palette - kg
BIII	BIII	BIII	BIII	BIII	BIII	BIII	Produktnorm
112000	531910-148	173368	532230-800	538020-400	182763	239996	weiß, glänzend <input type="checkbox"/>
Preisgr. A34 (m ²)	Preisgr. A25 (m ²)	Preisgr. A43 (m ²)	Preisgr. A25 (m ²)	Preisgr. A25 (m ²)	Preisgr. A43 (m ²)	Preisgr. A31 (m ²)	weiß, matt <input type="checkbox"/>
115100	531911-148	173369	532212-800	538021-400	182764	239995	weiß, glänzend, gewellt <input type="checkbox"/>
Preisgr. A34 (m ²)	Preisgr. A25 (m ²)	Preisgr. A43 (m ²)	Preisgr. A25 (m ²)	Preisgr. A25 (m ²)	Preisgr. A43 (m ²)	Preisgr. A31 (m ²)	weiß, matt, gewellt <input type="checkbox"/>
						239998	weiß, glänzend, gehämmert <input type="checkbox"/>
						Preisgr. A34 (m ²)	elfenbein, glänzend <input type="checkbox"/>
113063						239997	hellgrau marmoriert, glänzend <input type="checkbox"/>
Preisgr. A112 (m ²)						Preisgr. A34 (m ²)	hellgrau marmoriert, matt <input type="checkbox"/>
111052							beige marmoriert, glänzend <input type="checkbox"/>
Preisgr. A112 (m ²)							beige marmoriert, matt <input type="checkbox"/>
				538260-400		231032	hellgrau, matt <input type="checkbox"/>
				Preisgr. A31 (m ²)		Preisgr. A34 (m ²)	hellbeige, matt <input type="checkbox"/>
				538261-400		231034	
				Preisgr. A31 (m ²)		Preisgr. A34 (m ²)	
				538280-400			
				Preisgr. A31 (m ²)			
				538281-400			
				Preisgr. A31 (m ²)			
		173339	213341		183343		
		Preisgr. A52 (m ²)	Preisgr. A34 (m ²)		Preisgr. A55 (m ²)		
		173340	213342		183344		
		Preisgr. A52 (m ²)	Preisgr. A34 (m ²)		Preisgr. A55 (m ²)		

Wandfliesen

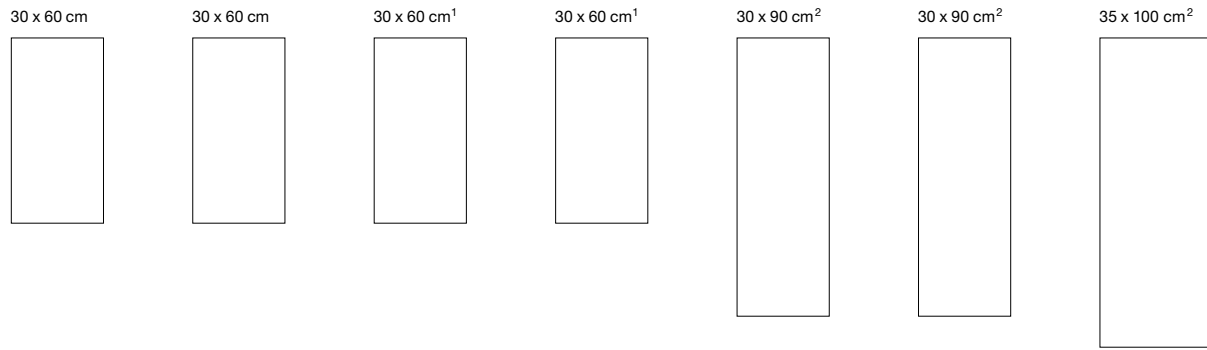

Nennmaß - cm/in	30 x 60 / 12 x 24	30 x 60 / 12 x 24	30 x 60 / 12 x 24	30 x 60 / 12 x 24	30 x 90 / 12 x 36	30 x 90 / 12 x 36	35 x 100 / 14 x 40
Herstellmaß	297 x 597 x 9,0 mm	297 x 597 x 6,0 mm	297 x 597 x 6,0 mm	297 x 597 x 9,0 mm	297 x 897 x 6,0 mm	297 x 897 x 10,5 mm	347 x 997 x 6 mm
Oberfläche	eben	eben	eben	eben	eben	eben	eben
m ² - Stück	5,556	5,556	5,556	5,556	3,704	3,704	2,857
m ² - kg	14,946	10,279	10,279	15,279	10,400	17,976	10,108
Paket - Stück	9	13	13	9	8	5	5
Paket - m ²	1,620	2,340	2,340	1,620	2,160	1,350	1,750
Paket - kg	24,210	24,050	24,050	24,750	22,464	24,265	17,690
Palette - m ²	77,754	112,311	112,311	77,754	51,836	32,397	70,004
Palette - kg	1.162,080	1.154,400	1.154,400	1.188,000	539,136	582,360	707,600
Produktnorm	BIII	BIII	BIII	BIII	BIII	BIII	BIII
weiß, glänzend <input type="checkbox"/>	280374 Preisgr. A34 (m ²)	203264 Preisgr. A34 (m ²)	203459R Preisgr. A52 (m ²)	282115R-02 Preisgr. A79 (m ²)	323260 Preisgr. A103 (m ²)	391589 Preisgr. A124 (m ²)	363335 Preisgr. A103 (m ²)
weiß, matt <input type="checkbox"/>	280375 Preisgr. A34 (m ²)	203265 Preisgr. A34 (m ²)	203460R Preisgr. A52 (m ²)	282116R-02 Preisgr. A79 (m ²)	323261 Preisgr. A103 (m ²)	391590 Preisgr. A124 (m ²)	363336 Preisgr. A103 (m ²)
weiß, glänzend, gewellt <input type="checkbox"/>	280718 Preisgr. A46 (m ²)						
weiß, matt, gewellt <input type="checkbox"/>	280719 Preisgr. A46 (m ²)						
weiß marmoriert, glänzend <input type="checkbox"/>		203444 Preisgr. A46 (m ²)					
weiß marmoriert, matt <input type="checkbox"/>		203445 Preisgr. A46 (m ²)					
sandbeige, glänzend <input type="checkbox"/>	280871 Preisgr. A46 (m ²)						
sandbeige, matt <input type="checkbox"/>	280872 Preisgr. A46 (m ²)						
hellgrau, matt <input type="checkbox"/>	283345 Preisgr. A46 (m ²)						
hellbeige, matt <input type="checkbox"/>	283346 Preisgr. A46 (m ²)						

Listel



Nennmaß - cm/in	1 x 20 / 3/8 x 8	4,5 x 20 / 1 13/16 x 8				
Herstellmaß	10 x 197 x 6,0 mm	45 x 197 x 6,0 mm				
Oberfläche	eben, seidenmatt	eben, seidenmatt				
m ² /m - Stück	5,000/m	5,000/m				
m ² /m - kg	0,125/m	0,505/m				
Paket - Stück	100	72				
Paket - m ² /m	20,000 m	14,400 m				
Paket - kg	2,500	7,272				
Palette - m ²						
Palette - kg						
Produktnorm	BIII	BIII				
candy <input type="checkbox"/>	533436-198 Preisgr. A423 (St.)	533434-198 Preisgr. A445 (St.)				

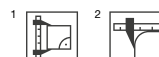

Wandfliesen

30 x 60 cm



30 x 60 cm¹

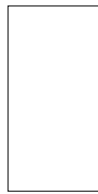

30 x 60 cm

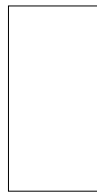

30 x 60 cm¹

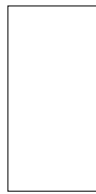

30 x 90 cm²

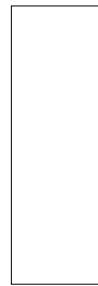

30 x 90 cm²



	30 x 60 / 12 x 24	30 x 60 / 12 x 24	30 x 60 / 12 x 24	30 x 60 / 12 x 24	30 x 90 / 12 x 36	30 x 90 / 12 x 36	Nennmaß - cm/in
	297 x 597 x 9,0 mm	297 x 597 x 9,0 mm	297 x 597 x 6,0 mm	297 x 597 x 6,0 mm	297 x 897 x 10,5 mm	297 x 897 x 6 mm	Herstellmaß
	eben	eben	eben	eben	eben	eben	Oberfläche
	5,556	5,556	5,556	5,556	3,704	3,704	m ² - Stück
	14,946	15,279	10,279	10,279	17,976	10,400	m ² - kg
	9	9	13	13	5	8	Paket - Stück
	1,620	1,620	2,340	2,340	1,350	2,160	Paket - m ²
	24,210	24,750	24,050	24,050	24,265	22,464	Paket - kg
	77,754	77,754	112,311	112,311	32,397	51,836	Palette - m ²
	1.162,080	1.188,000	1.154,400	1.154,400	582,360	539,136	Palette - kg
	BIII	BIII	BIII	BIII	BIII	BIII	Produktnorm
	289358	282887R	203266H	203461HR	391572	323262H	weiß, glänzend <input type="checkbox"/>
	Preisgr. A55 (m ²)	Preisgr. A94 (m ²)	Preisgr. A46 (m ²)	Preisgr. A64 (m ²)	Preisgr. A139 (m ²)	Preisgr. A115 (m ²)	weiß, matt <input type="checkbox"/>
	289359	282888R	203267H	203462HR	391573	323263H	weiß, glänzend, <input type="checkbox"/>
	Preisgr. A55 (m ²)	Preisgr. A94 (m ²)	Preisgr. A46 (m ²)	Preisgr. A64 (m ²)	Preisgr. A139 (m ²)	Preisgr. A115 (m ²)	gewellt <input type="checkbox"/>
	289360						weiß, matt, <input type="checkbox"/>
	Preisgr. A61 (m ²)						gewellt <input type="checkbox"/>
	289361						weiß, matt, <input type="checkbox"/>
	Preisgr. A61 (m ²)						gewellt <input type="checkbox"/>

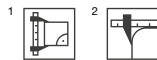

Wand-/Bodenfliesen

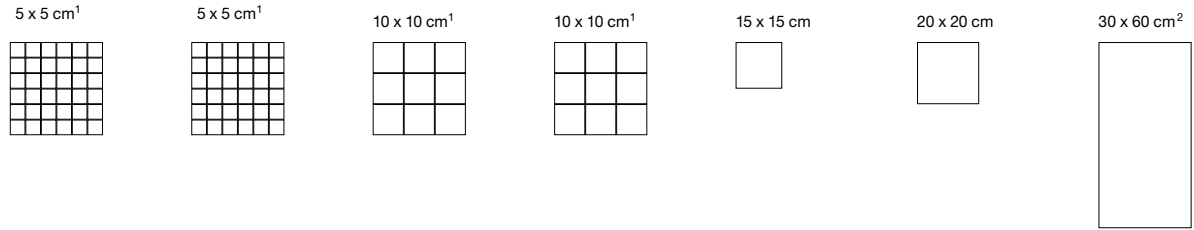

	Bogen: 297 x 297 mm	Bogen: 297 x 297 mm	Bogen: 297 x 297 mm	Bogen: 297 x 297 mm	Bogen: 297 x 297 mm	Bogen: 297 x 297 mm	Bogen: 297 x 297 mm
Nennmaß - cm/in	5 x 5 / 2 x 2	5 x 5 / 2 x 2	10 x 10 / 4 x 4	10 x 10 / 4 x 4	15 x 15 / 6 x 6	20 x 20 / 8 x 8	30 x 60 / 12 x 24
Herstellmaß	47 x 47 x 6,5 mm	47 x 47 x 6,5 mm	97 x 97 x 6,5 mm	97 x 97 x 6,5 mm	147 x 147 x 6,5 mm	197 x 197 x 6,5 mm	297 x 597 x 8,0 mm
Oberfläche	eben, matt	eben, matt	eben, matt	eben, matt	eben, matt	eben, matt	eben
m ² /m - Stück	11 Bögen	11 Bögen	11 Bögen/m ²	11 Bögen/m ²	44,000/m ²	25,000/m ²	5,556/m ²
m ² /m - kg	12,331	12,331	13,101/m ²	13,101/m ²	13,816/m ²	13,875/m ²	17,413/m ²
Paket - Stück	11 Bögen	11 Bögen	11 Bögen	11 Bögen	44	25	6
Paket - m ² /m	1,000	1,000	1,000 m ²	1,000 m ²	1,000 m ²	1,000 m ²	1,080 m ²
Paket - kg	12,331	12,331	13,101	13,101	13,816	13,875	18,804
Palette - m ²	64,000	64,000	64,000	64,000	80,000	72,000	43,197
Palette - kg	789,184	789,184	838,464	838,464	1.105,280	999,000	752,160
Produktnorm	Blb	Blb	Blb	Blb	Blb	Blb	Alb
Trittsicherheit		R10/B		R10/B			
Belastung	1	1	1	1	1	1	1
weiß matt <input type="checkbox"/>	4 431006 Preisgr. A148 (m ²)	4 431008 Preisgr. A157 (m ²)	4 620811-504 Preisgr. A91 (m ²)	4 600859-504 Preisgr. A115 (m ²)	4 620805-504 Preisgr. A73 (m ²)	4 620806-504 Preisgr. A61 (m ²)	4 430964 Preisgr. A112 (m ²)
weiß glänzend <input type="checkbox"/>	4						4 430963 Preisgr. A112 (m ²)
grau <input type="checkbox"/>	4 431007 Preisgr. A148 (m ²)	4 431009 Preisgr. A157 (m ²)	4 620811-505 Preisgr. A91 (m ²)	4 600859-505 Preisgr. A115 (m ²)	4 620805-505 Preisgr. A73 (m ²)	4 620806-505 Preisgr. A61 (m ²)	4 430965 Preisgr. A127 (m ²)
hellgrau matt <input type="checkbox"/>	4					4 430967 Preisgr. A94 (m ²)	4 430965 Preisgr. A127 (m ²)
hellbeige matt <input type="checkbox"/>	4					4 430968 Preisgr. A94 (m ²)	4 430966 Preisgr. A127 (m ²)



Hohlkehlsockel

10 x 10 cm³



	10 x 10 / 4 x 4						
Nennmaß - cm/in	10 x 10 / 4 x 4						
Herstellmaß	100 x 97 x 6,0 mm						
Oberfläche	eben, matt						
m - Stück	10,000						
m - kg	1,500						
Paket - Stück	40						
Paket - m	4,000						
Paket - kg	6,000						
Palette - m ²							
Palette - kg							
Produktnorm	Blb						
Trittsicherheit	R10/B						
weiß matt <input type="checkbox"/>	4 600864-504 Preisgr. A413 (St.)						
grau <input type="checkbox"/>	4 600864-505 Preisgr. A413 (St.)						

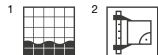

³ Details siehe S. 536 ff.

Wand-/Bodenfliesen

5 x 5 cm¹

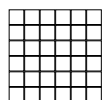

10 x 10 cm¹

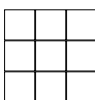

15 x 15 cm



15 x 15 cm



20 x 20 cm



20 x 20 cm



20 x 20 cm



protected

Bogen: 297 x 297 mm

Bogen: 297 x 297 mm

Micro

Softcorn 2

Micro

Softcorn 2

Perlstic

5 x 5 / 2 x 2	10 x 10 / 4 x 4	15 x 15 / 6 x 6	15 x 15 / 6 x 6	20 x 20 / 8 x 8	20 x 20 / 8 x 8	20 x 20 / 8 x 8
47 x 47 x 6,5 mm eben, matt	97 x 97 x 6,5 mm eben, matt	147 x 147 x 10,5 mm eben, matt	147 x 147 x 10,5 mm strukturiert, matt	197 x 197 x 9,0 mm eben, matt	197 x 197 x 9,0 mm strukturiert, matt	197 x 197 x 9,0 mm gekörnt, matt
11 Bögen	11 Bögen	44,444	44,444	25,000	25,000	25,000
12,331	13,101	23,111	23,111	19,450	19,450	19,450
11 Bögen	11 Bögen	27	27	25	25	25
1,000	1,000	0,608	0,608	1,000	1,000	1,000
12,331	13,101	14,040	14,040	19,450	19,450	19,450
64,000	64,000	48,600	48,600	60,000	60,000	60,000
789,184	838,464	1.123,200	1.123,200	1.167,000	1.167,000	1.167,000
Bla	Bla	Bla	Bla	Bla	Bla	Bla
R10/B	R10/B	R10/A	R11/B	R10/A	R11/B	R12
1	1	3	3	2	2	2
620510-070 Preisgr. A160 (m ²)	620460-070 Preisgr. A124 (m ²)	601500-070-71 Preisgr. A79 (m ²)	601550-070-71 Preisgr. A94 (m ²)	620249-070 Preisgr. A70 (m ²)	620450-070 Preisgr. A85 (m ²)	620470-070 Preisgr. A85 (m ²)
620510-072 Preisgr. A160 (m ²)	620460-072 Preisgr. A124 (m ²)	601500-072-71 Preisgr. A79 (m ²)	601550-072-71 Preisgr. A94 (m ²)	620249-072 Preisgr. A70 (m ²)	620450-072 Preisgr. A85 (m ²)	620470-072 Preisgr. A85 (m ²)
620510-073 Preisgr. A160 (m ²)	620460-073 Preisgr. A124 (m ²)			620249-073 Preisgr. A70 (m ²)	620450-073 Preisgr. A85 (m ²)	620470-073 Preisgr. A85 (m ²)
620510-075 Preisgr. A160 (m ²)	620460-075 Preisgr. A124 (m ²)	601500-075-71 Preisgr. A79 (m ²)	601550-075-71 Preisgr. A94 (m ²)	620249-075 Preisgr. A70 (m ²)	620450-075 Preisgr. A85 (m ²)	620470-075 Preisgr. A85 (m ²)

Nennmaß - cm/in	
Herstellmaß	
Oberfläche	
m ² - Stück	
m ² - kg	
Paket - Stück	
Paket - m ²	
Paket - kg	
Palette - m ²	
Palette - kg	
Produktnorm	
Trittsicherheit	
Belastung	
titanit	<input type="checkbox"/>
anthrazit	<input type="checkbox"/>
mittelgrau	<input type="checkbox"/>
kreide	<input type="checkbox"/>



Wand-/Bodenfliesen

20 x 20 cm



20 x 20 cm²



20 x 20 cm



20 x 20 cm



30 x 30 cm

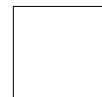

30 x 30 cm



protected

Opticorn

Picstic

Geraut

Kombicorn

Micro

Softcorn 2

20 x 20 / 8 x 8	20 x 20 / 8 x 8	20 x 20 / 8 x 8	20 x 20 / 8 x 8	30 x 30 / 12 x 12	30 x 30 / 12 x 12
197 x 197 x 9,0 mm genarbt, matt	197 x 197 x 9,0 mm genarbt, matt	197 x 197 x 9,0 mm profiliert, matt	197 x 197 x 9,0 mm profiliert, matt	297 x 297 x 9,0 mm strukturiert, matt	297 x 297 x 9,0 mm strukturiert, matt
25,000	25,000	25,000	25,000	11,111	11,111
19,450	19,450	19,450	19,450	19,478	19,478
25	25	25	25	13	13
1,000	1,000	1,000	1,000	1,170	1,170
19,450	19,450	19,450	19,450	22,789	22,789
60,000	60,000	60,000	60,000	56,161	56,161
1.167,000	1.167,000	1.167,000	1.167,000	1.093,872	1.093,872
Bla	Bla	Bla	Bla	Bla	Bla
R12V4	R12V8	R13	R13V10	R10	R11/B
2	2			2	2
620290-070 Preisgr. A85 (m ²)	620296-070 Preisgr. A127 (m ²)			620241-070 Preisgr. A43 (m ²)	
620290-072 Preisgr. A85 (m ²)	620296-072 Preisgr. A127 (m ²)	620480-072 Preisgr. A142 (m ²)	620490-072 Preisgr. A142 (m ²)	620241-072 Preisgr. A43 (m ²)	620245-072 Preisgr. A61 (m ²)
620290-073 Preisgr. A85 (m ²)				620241-073 Preisgr. A43 (m ²)	
620290-075 Preisgr. A85 (m ²)	620296-075 Preisgr. A127 (m ²)	620480-075 Preisgr. A142 (m ²)	620490-075 Preisgr. A142 (m ²)	620241-075 Preisgr. A43 (m ²)	

Nennmaß - cm/in	
Herstellmaß	
Oberfläche	
m ² - Stück	
m ² - kg	
Paket - Stück	
Paket - m ²	
Paket - kg	
Palette - m ²	
Palette - kg	
Produktnorm	
Trittsicherheit	
Belastung	
titanit	<input type="checkbox"/>
anthrazit	<input type="checkbox"/>
mittelgrau	<input type="checkbox"/>
kreide	<input type="checkbox"/>



² Auf Anfrage auch in 10,5 mm Stärke erhältlich

Bodenfliesen¹

Sockel, geschnitten¹

Treppenfliesen²

30 x 60 cm

30 x 60 cm

7 x 20 cm

7 x 30 cm

30 x 30 cm

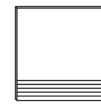

Nennmaß - cm/in	30 x 60 / 12 x 24	30 x 60 / 12 x 24	7 x 20 / 2 13/16 x 8	7 x 30 / 2 13/16 x 12	30 x 30 / 12 x 12		
Herstellmaß	297 x 597 x 9 mm	297 x 597 x 9 mm	70 x 197 x 9,0 mm	70 x 297 x 9,0 mm	297 x 297 x 9,0 mm		
Oberfläche	eben, matt	eben, matt	eben, matt	eben, matt	eben, matt		
m ² /m - Stück	5,556/m ²	5,556/m ²	5,000/m	3,333/m	3,333/m		
m ² /m - kg	19,907/m ²	19,907/m ²	1,400/m	1,399/m	5,906/m		
Paket - Stück	7	7	60	50	11		
Paket - m ² /m	1,260 m ²	1,260 m ²	12,000 m	15,001 m	3,300 m		
Paket - kg	25,081	25,081	16,800	21,000	19,492		
Palette - m ²	50,396	50,396					
Palette - kg	1.003,240	1.003,240					
Produktnorm	Bla	Bla	Bla	Bla	Bla		
Trittsicherheit	R10/A	R11/B			R10		
Belastung	2				2		
titanit <input type="checkbox"/>	436100 Preisgr. A88 (m ²)	436104 Preisgr. A115 (m ²)	600334-070 Preisgr. A409 (St.)	600384-070 Preisgr. A410 (St.)	600499-070 Preisgr. A425 (St.)		
anthrazit <input type="checkbox"/>	436101 Preisgr. A88 (m ²)	436105 Preisgr. A115 (m ²)	600334-072 Preisgr. A409 (St.)	600384-072 Preisgr. A410 (St.)	600499-072 Preisgr. A425 (St.)		
mittelgrau <input type="checkbox"/>	436102 Preisgr. A88 (m ²)	436106 Preisgr. A115 (m ²)	600334-073 Preisgr. A409 (St.)	600384-073 Preisgr. A410 (St.)	600499-073 Preisgr. A425 (St.)		
kreide <input type="checkbox"/>	436103 Preisgr. A88 (m ²)	436107 Preisgr. A115 (m ²)	600334-075 Preisgr. A409 (St.)	600384-075 Preisgr. A410 (St.)	600499-075 Preisgr. A425 (St.)		



Hohlkehlssockel³

Innenecke zu Hohlkehlssockel^{3/4}

Außenecke zu Hohlkehlssockel^{3/4}

Duschtassensystem⁵

10 x 10 cm

10 x 15 cm

10 x 20 cm

10 x 10 cm

10 x 10 cm



Nennmaß - cm/in	10 x 10 / 4 x 4	10 x 15 / 4 x 6	10 x 20 / 4 x 8			Softcorn Läufer	Softcorn Ecke
Herstellmaß	100 x 97 x 6,0 mm	102 x 147 x 9 mm	102 x 197 x 9,0 mm	102 x 20 x 9,0 mm	102 x 35 x 9,0 mm	97 x 97 x 9 mm	97 x 97 x 9 mm
Oberfläche	eben, matt	eben, matt	eben, matt	eben, matt	eben, matt	eben, matt	genarbt, matt
m - Stück	10,000	6,667	5,000			10,000	
m/St. - kg	1,500/m	2,000/m	2,000/m	0,080/Stück	0,080/Stück	2,020/m	0,202/Stück
Paket - Stück	40	24	20	18	12	6	4
Paket - m	4,000	3,600	4,000			0,600	
Paket - kg	6,000	7,200	8,000	1,440	0,960	1,212	0,808
Palette - m							
Palette - kg							
Produktnorm	Bla	Bla	Bla	Bla	Bla	Bla	Bla
Trittsicherheit	R10/B	R10/A	R10/A			R11/B	R11/B
titanit <input type="checkbox"/>	600450-070 Preisgr. A409 (St.)	600430-070-71 Preisgr. A413 (St.)	600420-070 Preisgr. A413 (St.)	600416-070 Preisgr. A416 (St.)	600417-070 Preisgr. A416 (St.)	600442-070 Preisgr. A425 (St.)	600443-070 Preisgr. A451 (St.)
anthrazit <input type="checkbox"/>	600450-072 Preisgr. A409 (St.)	600430-072-71 Preisgr. A413 (St.)	600420-072 Preisgr. A413 (St.)	600416-072 Preisgr. A416 (St.)	600417-072 Preisgr. A416 (St.)	600442-072 Preisgr. A425 (St.)	600443-072 Preisgr. A451 (St.)
mittelgrau <input type="checkbox"/>	600450-073 Preisgr. A409 (St.)		600420-073 Preisgr. A413 (St.)	600416-073 Preisgr. A416 (St.)	600417-073 Preisgr. A416 (St.)	600442-073 Preisgr. A425 (St.)	600443-073 Preisgr. A451 (St.)
kreide <input type="checkbox"/>	600450-075 Preisgr. A409 (St.)	600430-075-71 Preisgr. A413 (St.)	600420-075 Preisgr. A413 (St.)	600416-075 Preisgr. A416 (St.)	600417-075 Preisgr. A416 (St.)	600442-075 Preisgr. A425 (St.)	600443-075 Preisgr. A451 (St.)

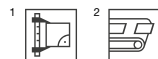

³ Details siehe S. 536 ff.

⁴ Passend zu Hohlkehlssockel 10 x 15 cm und 10 x 20 cm.

⁵ Details siehe S. 534

Wand-/Bodenplatten

25 x 12,5 cm



25 x 12,5 cm



25 x 12,5 cm



(8 mm stark)

(6 mm stark)

(8 mm stark)

				(8 mm stark)	(6 mm stark)	(8 mm stark)	Beanspruchungsgruppe	Formatnummer
				38110	18120	8110		Nennmaß - cm/in
				25 x 12,5 / 10 x 5	25 x 12,5 / 10 x 5	25 x 12,5 / 10 x 5		Herstellmaß
				244 x 119 x 8 mm	244 x 119 x 6 mm	240 x 115 x 8 mm		Oberfläche
				eben	eben	eben		m ² - Stück
				32,000	32,000	32,000		m ² - kg
				15,680	12,160	14,720		Paket - Stück
				33	44	33		Paket - m ²
				1,031	1,375	1,000		Paket - kg
				16,170	16,720	15,180		Palette - m ²
				86,625	115,500	84,000		Palette - kg
				1.358,280	1.404,480	1.275,120		Produktnorm
				Alb	Alb	Alb		
				700-38110	700-18120	75917-8110	3	weiß glänzend <input type="checkbox"/> VO
				Preisgr. A73 (m ²)	Preisgr. A73 (m ²)	Preisgr. A61 (m ²)		
				701-38110	701-18120	75918-8110	4	weiß matt <input type="checkbox"/> VO
				Preisgr. A73 (m ²)	Preisgr. A73 (m ²)	Preisgr. A61 (m ²)		
					509-18120		4	grau <input type="checkbox"/> VO
					Preisgr. A112 (m ²)			transparent matt <input type="checkbox"/> VO
					711-18120		4	lichtgrau matt <input type="checkbox"/> VO
					Preisgr. A112 (m ²)			
				703-38110	703-18120		4	lichtsahara matt <input type="checkbox"/> VO
				Preisgr. A112 (m ²)	Preisgr. A112 (m ²)			
					732-18120		3	softazur glänzend <input type="checkbox"/> VO
					Preisgr. A112 (m ²)			
						71152-8110	3	lichtblau glänzend <input type="checkbox"/> VO
						Preisgr. A112 (m ²)		
					563-18120		1	azurdunkel glänzend <input type="checkbox"/> VO
					Preisgr. A112 (m ²)			







Funktional und vielseitig

Basis Pro erweitert das etablierte Basisprogramm um Feinsteinzeug-Produkte in zeitgemäßem und langlebigem Design. Basis Pro ist ein kompaktes Sortiment aus Bodenfliesen in klassischen Formaten, langlebigen Basisfarben und einer Auswahl an Trittsicherheiten, die auf den soliden Objektbereich abgestimmt ist. Die Serie bietet funktionale, keramische Lösungen für öffentliche Gebäude und Wohnbau.

Rendering



sandbeige



aschbraun



betongrau



basalt

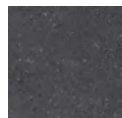

anthrazit



Bodenfliese 15 x 15 cm
eben, R10/B



Bodenfliese 30 x 30 cm, eben, R10/A
Bodenfliese 30 x 30 cm, eben, R11/B



Bodenfliese 10 x 60 cm, eben, R10/A



Bodenfliese 15 x 60 cm, eben, R10/A



Bodenfliese 30 x 60 cm, eben, R10/A
Bodenfliese 30 x 60 cm, eben, R11/B
Bodenfliese 30 x 60 cm, eben, R12/C

Mosaik 5 x 5 cm

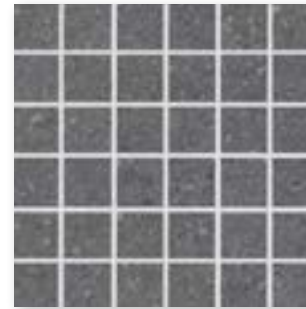

Mosaikbogen 30 x 30 cm, eben,
R10/B



Rückseitig thermoplastisch verklebte Mosaik von Agrob Buchtal sind nicht nur im Trockenbereich, sondern auch bedenkenlos im Unterwasserbereich (z.B. Schwimmbecken/Whirlpool) sowie im dauernassbelasteten Bereich (z.B. Beckenumgänge/Duschen) einsetzbar.



Bodenfliese 60 x 60 cm, eben, R10/A

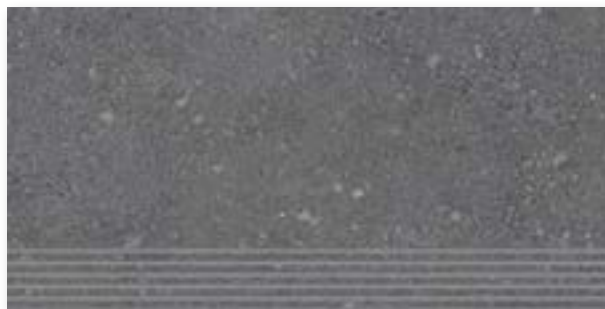

Treppenfliese 30 x 60 cm (rilliert), eben, R10/A



Sockel, gerundet 7 x 60 cm, eben



Hohlkehlssockel 10 x 30 cm
eben, R10/A

Mosaik

Bodenfliesen

5 x 5 cm¹



15 x 15 cm



30 x 30 cm



30 x 30 cm



30 x 30 cm^{3/4}



10 x 60 cm^{2/3}



15 x 60 cm^{2/3}

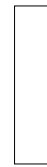

protected

Bogen 297 x 297 mm

überstark

Riegelformat

Riegelformat

Nennmaß - cm/in	5 x 5 / 2 x 2	15 x 15 / 6 x 6	30 x 30 / 12 x 12	30 x 30 / 12 x 12	30 x 30 / 12 x 12	10 x 60 / 4 x 24	15 x 60 / 6 x 24
Herstellmaß	47 x 47 x 6,5 mm	147 x 147 x 9 mm	297 x 297 x 9 mm	297 x 297 x 9 mm	297 x 297 x 14 mm	97 x 597 x 9 mm	147 x 597 x 9 mm
Oberfläche	eben, matt	eben, matt	eben, matt	eben, matt	eben, matt	eben, matt	eben, matt
m ² - Stück	11 Bögen	44,444	11,111	11,111	11,337	16,667	11,111
m ² - kg	12,331	19,822	19,478	19,478	32,027	20,283	19,900
Paket - Stück	11 Bögen	32	13	13	8	17	13
Paket - m ²	1,000	0,720	1,170	1,170	0,706	1,020	1,170
Paket - kg	12,331	14,272	22,789	22,789	22,600	20,689	23,283
Palette - m ²	64,000	57,601	56,161	56,161	33,871	40,799	46,800
Palette - kg	789,184	1.141,760	1.093,880	1.093,872	1.084,800	827,560	931,311
Produktnorm	Bla	Bla	Bla	Bla	Bla	Bla	Bla
Trittsicherheit	R10/B	R10/B	R10/A	R11/B	R10	R10/A	R10/A
Belastung	1	2	2	2	4	2	2
sandbeige	430901 Preisgr. A181 (m ²)	430906 Preisgr. A109 (m ²)	430911 Preisgr. A61 (m ²)	431045 Preisgr. A61 (m ²)		430916 Preisgr. A169 (m ²)	430921 Preisgr. A169 (m ²)
aschbraun	430902 Preisgr. A181 (m ²)	430907 Preisgr. A109 (m ²)	430912 Preisgr. A61 (m ²)	431046 Preisgr. A61 (m ²)		430917 Preisgr. A169 (m ²)	430922 Preisgr. A169 (m ²)
betongrau	430903 Preisgr. A181 (m ²)	430908 Preisgr. A109 (m ²)	430913 Preisgr. A61 (m ²)	431047 Preisgr. A61 (m ²)	430993	430918 Preisgr. A169 (m ²)	430923 Preisgr. A169 (m ²)
basalt	430904 Preisgr. A181 (m ²)	430909 Preisgr. A109 (m ²)	430914 Preisgr. A61 (m ²)	431048 Preisgr. A61 (m ²)		430919 Preisgr. A169 (m ²)	430924 Preisgr. A169 (m ²)
anthrazit	430905 Preisgr. A181 (m ²)	430910 Preisgr. A109 (m ²)	430915 Preisgr. A61 (m ²)	431049 Preisgr. A61 (m ²)		430920 Preisgr. A169 (m ²)	430925 Preisgr. A169 (m ²)

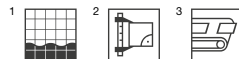

⁴ Preistellungen werden objektspezifisch kalkuliert

Bodenfliesen

30 x 60 cm¹



30 x 60 cm^{2/3/4}

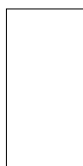

30 x 60 cm¹



30 x 60 cm¹



60 x 60 cm¹



60 x 60 cm^{2/3/4}



protected

	überstark			überstark			
	30 x 60 / 12 x 24	30 x 60 / 12 x 24	30 x 60 / 12 x 24	30 x 60 / 12 x 24	60 x 60 / 24 x 24	60 x 60 / 24 x 24	Nennmaß - cm/in
	297 x 597 x 9 mm	300 x 600 x 14 mm	297 x 597 x 9 mm	297 x 597 x 9 mm	597 x 597 x 9 mm	600 x 600 x 14 mm	Herstellmaß
	eben, matt	eben, matt	eben, matt	eben, matt	eben, matt	eben, matt	Oberfläche
	5,556	5,589	5,556	5,556	2,778	2,778	m ² - Stück
	19,907	32,159	19,907	19,907	20,371	31,669	m ² - kg
	7	4	7	7	3	2	Paket - Stück
	1,260	0,716	1,260	1,260	1,080	0,720	Paket - m ²
	25,081	23,016	25,081	25,081	21,999	22,800	Paket - kg
	50,396	28,628	50,396	50,396	45,356	30,238	Palette - m ²
	1.003,240	920,640	1.003,240	1.003,240	923,958	957,600	Palette - kg
	Bla	Bla	Bla	Bla	Bla	Bla	Produktnorm
	R10/A	R10	R11/B	R12/C	R10/A	R10	Trittsicherheit
	2	3 - 4	2	2	2	3 - 4	Belastung
	430926	430997	430931	430936	430941	430979	sandbeige <input type="checkbox"/> V2
	Preisgr. A106 (m ²)		Preisgr. A106 (m ²)	Preisgr. A124 (m ²)	Preisgr. A121 (m ²)		
	430927	430996	430932	430937	430942	430978	aschbraun <input type="checkbox"/> V2
	Preisgr. A106 (m ²)		Preisgr. A106 (m ²)	Preisgr. A124 (m ²)	Preisgr. A121 (m ²)		
	430928	430995	430933	430938	430943	430977	betongrau <input type="checkbox"/> V2
	Preisgr. A106 (m ²)		Preisgr. A106 (m ²)	Preisgr. A124 (m ²)	Preisgr. A121 (m ²)		
	430929		430934	430939	430944		basalt <input type="checkbox"/> V2
	Preisgr. A106 (m ²)		Preisgr. A106 (m ²)	Preisgr. A124 (m ²)	Preisgr. A121 (m ²)		
	430930		430935	430940	430945		anthrazit <input type="checkbox"/> V2
	Preisgr. A106 (m ²)		Preisgr. A106 (m ²)	Preisgr. A124 (m ²)	Preisgr. A121 (m ²)		



⁴ Preistellungen werden objektspezifisch kalkuliert



Hohlkehls-
sockel,
dekoriert^{3/4}

10 x 30 cm



Treppen-
fliesen^{1/2}

30 x 60 cm

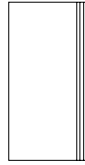

Sockel,
gerundet¹

7 x 60 cm



Nennmaß - cm/in	10 x 30 / 4 x 12	30 x 60 / 12 x 24	7 x 60 / 2 13/16 x 24			
Herstellmaß	102 x 297 x 9 mm	297 x 597 x 9 mm	70 x 597 x 9 mm			
Oberfläche	eben, matt	eben, matt	eben, matt			
m - Stück	3,333	1,667	1,667			
m - kg	1,999	5,973	1,357			
Paket - Stück	16	7	15			
Paket - m	4,800	4,199	8,998			
Paket - kg	9,600	25,081	12,210			
Palette - m ²						
Palette - kg						
Produktnorm	Bla	Bla	Bla			
Trittsicherheit	R10/A	R10/A				
Belastung		2				
sandbeige	430946 Preisgr. A422 (St.)	<i>430951</i> <i>Preisgr. A456 (St.)</i>	430956 Preisgr. A438 (St.)			
aschbraun	430947 Preisgr. A422 (St.)	<i>430952</i> <i>Preisgr. A456 (St.)</i>	430957 Preisgr. A438 (St.)			
betongrau	430948 Preisgr. A422 (St.)	<i>430953</i> <i>Preisgr. A456 (St.)</i>	430958 Preisgr. A438 (St.)			
basalt	430949 Preisgr. A422 (St.)	<i>430954</i> <i>Preisgr. A456 (St.)</i>	430959 Preisgr. A438 (St.)			
anthrazit	430950 Preisgr. A422 (St.)	<i>430955</i> <i>Preisgr. A456 (St.)</i>	430960 Preisgr. A438 (St.)			

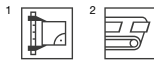

³ Details siehe S. 536

⁴ Produktionsbedingte Farbabweichungen zum angrenzenden Belag bei liegender Verlegung sind nicht reklamationsfähig

Rendering



Maximiliancenter am Hauptbahnhof, Bonn, Deutschland / Architekt: Forum Architekten & Planners BV
Serie: Blindenleitsystem / Foto: Jochen Stüber





Blindenleitfliesen

Bodenfliese

30 x 30 cm

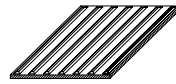

30 x 30 cm



30 x 30 cm



				30 x 30 / 12 x 12	30 x 30 / 12 x 12	30 x 30 / 12 x 12	Nennmaß - cm/in
				297 x 297 x 10,5 mm	297 x 297 x 10,5 mm	297 x 297 x 10,5 mm	Herstellmaß
				Rippenstruktur	Noppenstruktur	eben, matt	Oberfläche
				3,333/m	3,333/m	11,111/m ²	m ² /m - Stück
				7,999/m	7,999/m	23,144/m ²	m ² /m - kg
				8	8	11	Paket - Stück
				2,400 m	2,400 m	0,990 m ²	Paket - m/m ²
				19,200	19,200	22,913	Paket - kg
						47,520	Palette - m ²
						1.099,824	Palette - kg
				Bla	Bla	Bla	Produktnorm
				R11	R11	R11	Trittsicherheit
				3	3	3	Belastung
				600356-103-70	600355-103-70	600357-103-70	kreide <input type="checkbox"/> V0
				Preisgr. A455 (St.)	Preisgr. A539 (St.)	Preisgr. A190 (m ²)	
				600356-106-70	600355-106-70	600357-106-70	graphit <input type="checkbox"/> V0
				Preisgr. A455 (St.)	Preisgr. A539 (St.)	Preisgr. A190 (m ²)	
				430304H-R	430304H-N	430304-N	Area Pro anthrazit <input type="checkbox"/> V2
				Preisgr. A455 (St.)	Preisgr. A539 (St.)	Preisgr. A190 (m ²)	
				430312H-R	430312H-N	430312-N	Area Pro platin <input type="checkbox"/> V2
				Preisgr. A455 (St.)	Preisgr. A539 (St.)	Preisgr. A190 (m ²)	





Bodenplatte 15,4 x 15,4 cm
Rippenstruktur, kreide, R11

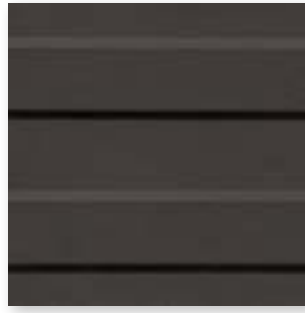

Bodenplatte 15,4 x 15,4 cm
Rippenstruktur, anthrazit, R11

Blindenleitplatte: 6635

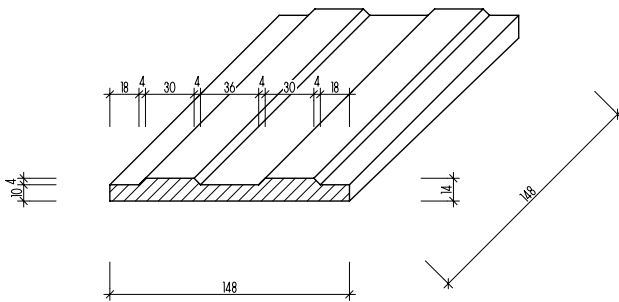

Blindenleitplatte: 6636

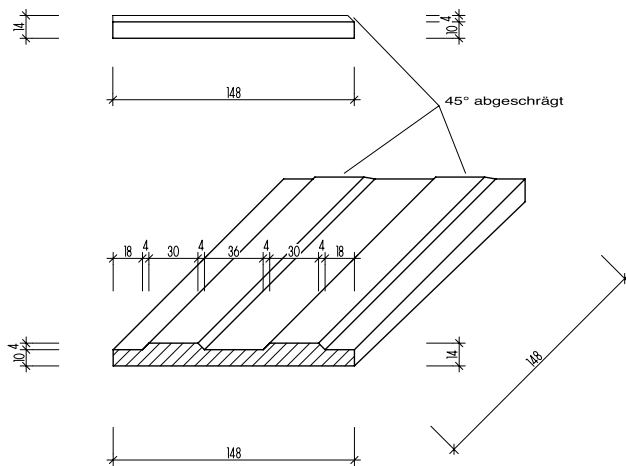

Blindenleitplatten^{1/2/3}

15,4 x 15,4 cm



15,4 x 15,4 cm



*einseitig abgeschrägt,
Rippenstruktur*

					6635	6636	Formatnummer
					15,4 x 15,4 / 63/16 x 63/16	15,4 x 15,4 / 63/16 x 63/16	Nennmaß - cm/in
					148 x 148 x 10 mm	148 x 148 x 10 mm	Herstellmaß
					Rippenstruktur	Rippenstruktur	Oberfläche
					6,494	6,494	m - Stück
					3,318	3,318	m - kg
					20	20	Paket - Stück
					3,080	3,080	Paket - m
					10,220	10,220	Paket - kg
							Palette - m
							Palette - kg
					Alb	Alb	Produktnorm
					R11	R11	Trittsicherheit
					3	3	Belastung
					103197-6635	103197-6636	
					Preisgr. A428 (St.)	Preisgr. A442 (St.)	kreide <input type="checkbox"/>
					101630-6635	101630-6636	
					Preisgr. A428 (St.)	Preisgr. A442 (St.)	anthrazit <input type="checkbox"/>



³ Kopfkanten rektifiziert







Edle Marmoroptik

Der natürliche Ausdruck des italienischen Marmors und das großzügige Format machen Bliss zu etwas Besonderem. Besonders eindrucksvoll ist die Verbindung der Grundfliesen mit dem frisch-farbigen Flächendekor Paradise. Die Fliesen harmonieren mit unterschiedlichen Bodenfliesenserien, sie sind Hytect-veredelt und daher besonders hygienisch.

Rendering



Wandfliese 35 x 100 cm, white calacatta, eben

Dekorationselemente



Dekorfliese Paradise 35 x 100 cm, green-blue Mix, eben

Wandfliesen¹

Dekorations-
elemente^{1/2/3}

35 x 100 cm



35 x 100 cm

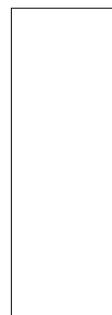

35 x 100 cm

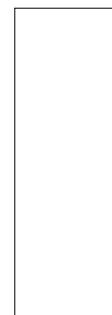

				<i>Dekorfliese Paradise</i>			
			35 x 100 / 14 x 40	35 x 100 / 14 x 40	35 x 100 / 14 x 40		Nennmaß - cm/in
			347 x 997 x 6 mm	347 x 997 x 6 mm	347 x 997 x 6 mm		Herstellmaß
			eben, seidenmatt	eben, glänzend	eben, seidenmatt		Oberfläche
			2,857	2,857	2,857		m ² - Stück
			10,108	10,108	10,108		m ² - kg
			5	5	5		Paket - Stück
			1,750	1,750	1,750		Paket - m ²
			17,690	17,690	17,690		Paket - kg
			70,004	70,004	70,004		Palette - m ²
			707,600	707,600	707,600		Palette - kg
			BIII	BIII	BIII		Produktnorm
			363428H	363429H			white calacatta <input type="checkbox"/> V3
			Preisgr. C134 (m ²)	Preisgr. C134 (m ²)	363430H		green-blue Mix <input type="checkbox"/> V4
					Preisgr. C143 (m ²)		



¹ Abgabe der Dekorationselemente ausschließlich in vollen Kartons.

² Bei der von Ihnen ausgewählten Dekoration handelt es sich um ein hochwertiges Produkt aus Steingut glasiert. Die Dekoration besteht aus unterschiedlichen Einzelbildern. Die Anschlüsse der Einzelbilder sind bewusst frei gestaltet und verbinden sich somit nicht in der fortlaufenden Verlegung. Die Motivzusammenstellung im Karton kann produktionsbedingt variieren.





Von Holz inspiriert

Mit ihrer dezenten Erinnerung an Holzoberflächen ist Cedra die perfekte Wahl für eine wohnliche Badgestaltung. Die beiden Wandfliesenfarben in zwei Formaten lassen sich gut mit den Bordüren kombinieren. Diese Bordüren, die mit und ohne Einleger aus Feinsteinzeug verfügbar sind, setzen optische Akzente. Sie greifen die drei klassischen Farben des Bodens auf. Besonders praktisch: Zusätzlich zur Bodenfliese kann man den Duschbereich mit einem passenden Mosaik in R10/B fortführen. Die Wandfliesen sind durch ihre Hytect-Oberfläche besonders reinigungsfreundlich.

Rendering



Wandfliese 30 x 60 cm, weiß-creme, eben



Wandfliese 30 x 60 cm, beige, eben



Wandfliese 30 x 90 cm, weiß-creme, eben



Wandfliese 30 x 90 cm, beige, eben

Dekorationselemente



Bordüre mit Feinsteinzeuginleger 10 x 60 cm, grau, eben

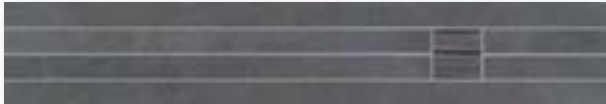

Bordüre mit Feinsteinzeuginleger 10 x 60 cm, anthrazit, eben



Bordüre mit Feinsteinzeuginleger 10 x 60 cm, schlamm, eben



Bordüre 10 x 60 cm, grau, eben



Bordüre 10 x 60 cm, anthrazit, eben



Bordüre 10 x 60 cm, schlamm, eben

Dekorationselemente



Bordüre mit Feinsteinzeuginleger 10 x 90 cm, grau, eben



Bordüre mit Feinsteinzeuginleger 10 x 90 cm, anthrazit, eben



Bordüre mit Feinsteinzeuginleger 10 x 90 cm, schlamm, eben



Bordüre 10 x 90 cm, grau, eben



Bordüre 10 x 90 cm, anthrazit, eben

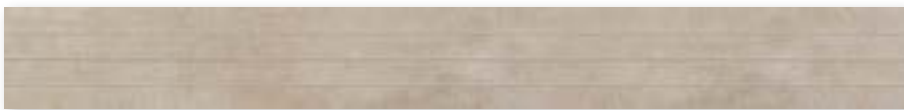

Bordüre 10 x 90 cm, schlamm, eben

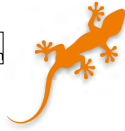

R9 R10/B

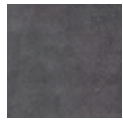

anthrazit



grau



schlamm



Bodenfliese 30 x 60 cm, eben, R9

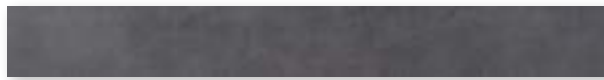

Sockel, gerundet 7 x 60 cm, eben

Mosaik 5 x 5 cm

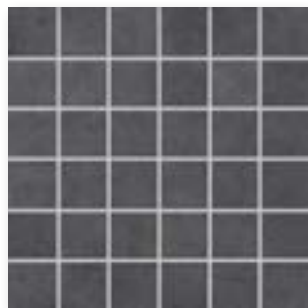

Mosaikbogen 30 x 30 cm
anthrazit, eben, R10/B

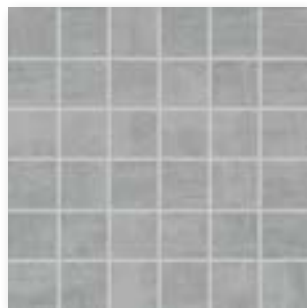

Mosaikbogen 30 x 30 cm
grau, eben, R10/B



Mosaikbogen 30 x 30 cm
schlamm, eben, R10/B

Mosaik: Verklebung rückseitig auf Glasfasernetz,
Bogen: 297 x 297 mm

Wandfliese

Dekorationselemente^{2/3/4/5/6}

30 x 60 cm



30 x 90 cm¹

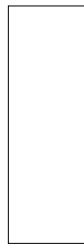

10 x 60 cm



10 x 60 cm



10 x 90 cm



10 x 90 cm



Nennmaß - cm/in	30 x 60 / 12 x 24	30 x 90 / 12 x 36	10 x 60 / 4 x 24	10 x 60 / 4 x 24	10 x 90 / 4 x 36	10 x 90 / 4 x 36
Herstellmaß	297 x 597 x 9 mm	297 x 897 x 10,5 mm	97 x 597 x 10,5 mm	97 x 597 x 10,5 mm	97 x 897 x 10,5 mm	97 x 897 x 10,5 mm
Oberfläche	eben, seidenmatt	eben, seidenmatt	eben, matt	eben, matt	eben, matt	eben, matt
m ² /m - Stück	5,556/m ²	3,704/m ²	1,667/m	1,667/m	1,111/m	1,111/m
m ² /m - kg	14,946/m ²	17,976/m ²	2,167/m	2,167/m	2,166/m	2,166/m
Paket - Stück	9	5	4	4	2	2
Paket - m ² /m	1,620 m ²	1,350 m ²	2,400 m	2,400 m	1,800 m	1,800 m
Paket - kg	24,210	24,265	5,200	5,200	3,900	3,900
Palette - m ²	77,754	32,397				
Palette - kg	1.162,080	582,360				
Produktnorm	BIII	BIII	Bla	Bla	Bla	Bla
weiß-creme <input type="checkbox"/>	281726 Preisgr. C89 (m ²)	392720 Preisgr. C149 (m ²)				
beige <input type="checkbox"/>	281727 Preisgr. C89 (m ²)	392721 Preisgr. C149 (m ²)				
grau <input type="checkbox"/>			281728 Preisgr. C474 (St.)	281729 Preisgr. C466 (St.)	392723 Preisgr. C491 (St.)	392724 Preisgr. C486 (St.)
anthrazit <input type="checkbox"/>			281730 Preisgr. C474 (St.)	281731 Preisgr. C466 (St.)	392725 Preisgr. C491 (St.)	392726 Preisgr. C486 (St.)
schlamm <input type="checkbox"/>			281732 Preisgr. C474 (St.)	281733 Preisgr. C466 (St.)	392727 Preisgr. C491 (St.)	392728 Preisgr. C486 (St.)

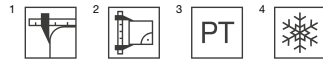

⁵ Verklebung rückseitig auf Glasfasernetz
⁶ Abgabe der Dekorationselemente ausschließlich in vollen Kartons

Mosaik^{1/2}

5 x 5 cm



Bodenfliesen¹ Sockel, gerundet¹

30 x 60 cm



7 x 60 cm



protected

Bogen: 297 x 297 mm

				5 x 5 / 2 x 2	30 x 60 / 12 x 24	7 x 60 / 2 13/16 x 24		Nennmaß - cm/in	
				47 x 47 x 10,5 mm	297 x 597 x 10,5 mm	70 x 597 x 10,5 mm		Herstellmaß	
				eben, matt	eben, matt	eben, matt		Oberfläche	
				11,11 Bögen/m ²	5,556/m ²	1,667/m		m ² /m - Stück	
				22,222/m ²	23,224/m ²	1,584/m		m ² /m - kg	
				11 Bögen	6	22		Paket - Stück	
				0,990 m ²	1,080 m ²	13,197 m		Paket - m ² /m	
				22,000	25,080	20,900		Paket - kg	
				29,700	43,197			Palette - m ²	
				660,000	1.003,200			Palette - kg	
				Bla	Bla	Bla		Produktnorm	
				R10/B	R9			Trittsicherheit	
				2	2			Belastung	
				433757	433692	433695		anthrazit	V2
				Preisgr. C314 (m ²)	Preisgr. C116 (m ²)	Preisgr. C440 (St.)		grau	V2
				433756	433693	433696			
				Preisgr. C314 (m ²)	Preisgr. C116 (m ²)	Preisgr. C440 (St.)			
				433758	433694	433697			
				Preisgr. C314 (m ²)	Preisgr. C116 (m ²)	Preisgr. C440 (St.)		schlamm	V3



² Verklebung rückseitig auf Glasfasernetz





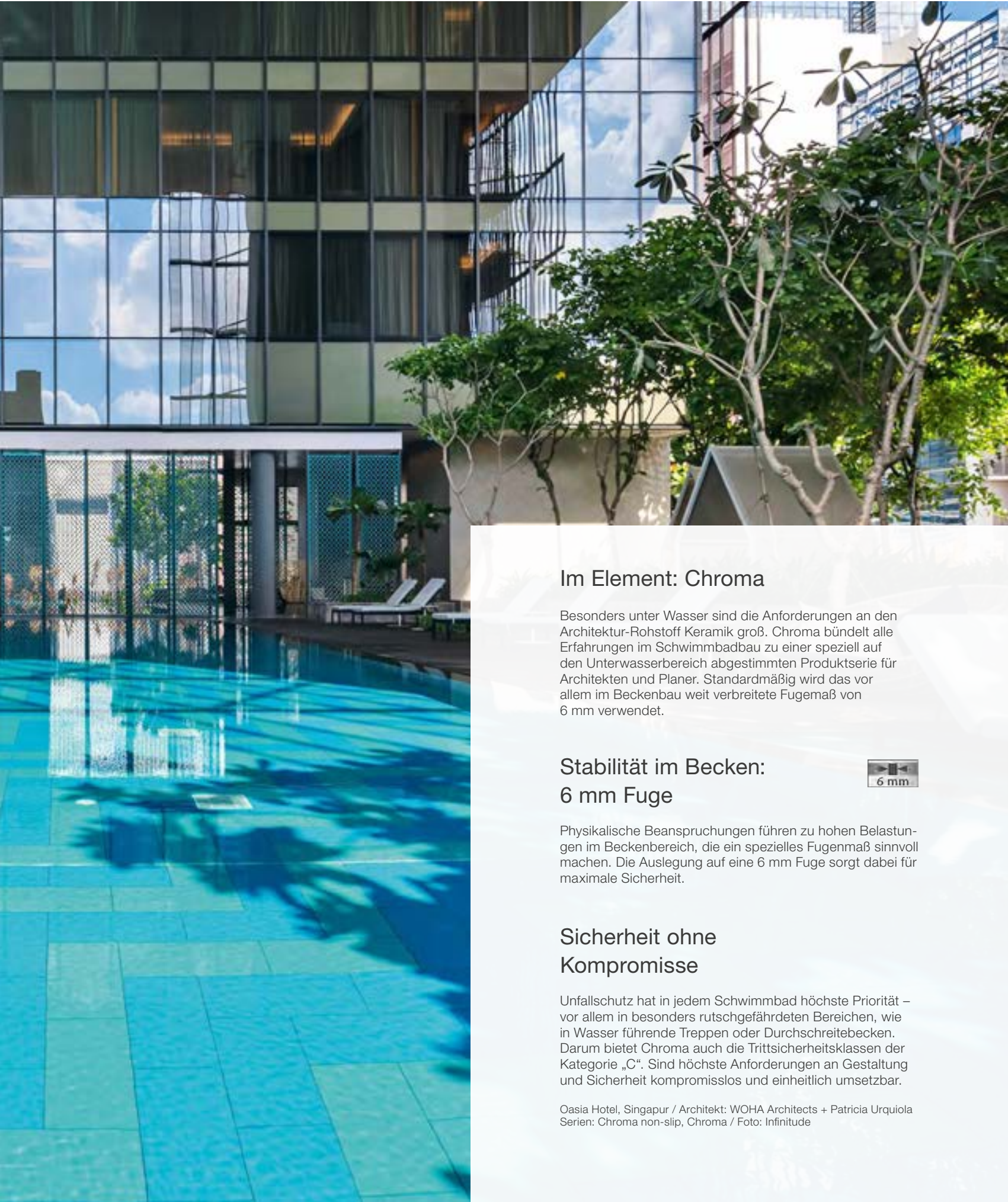

Im Element: Chroma

Besonders unter Wasser sind die Anforderungen an den Architektur-Rohstoff Keramik groß. Chroma bündelt alle Erfahrungen im Schwimmbadbau zu einer speziell auf den Unterwasserbereich abgestimmten Produktserie für Architekten und Planer. Standardmäßig wird das vor allem im Beckenbau weit verbreitete Fugemaß von 6 mm verwendet.

Stabilität im Becken: 6 mm Fuge



Physikalische Beanspruchungen führen zu hohen Belastungen im Beckenbereich, die ein spezielles Fugenmaß sinnvoll machen. Die Auslegung auf eine 6 mm Fuge sorgt dabei für maximale Sicherheit.

Sicherheit ohne Kompromisse

Unfallschutz hat in jedem Schwimmbad höchste Priorität – vor allem in besonders rutschgefährdeten Bereichen, wie in Wasser führende Treppen oder Durchschreibecken. Darum bietet Chroma auch die Trittsicherheitsklassen der Kategorie „C“. Sind höchste Anforderungen an Gestaltung und Sicherheit kompromisslos und einheitlich umsetzbar.

Oasia Hotel, Singapur / Architekt: WOHA Architects + Patricia Urquiola
Serien: Chroma non-slip, Chroma / Foto: Infinitude

FARBSYSTEM UNICOLOR – Vom Farb- zum Möglichkeitsraum



Kontrastfarben (glänzend)

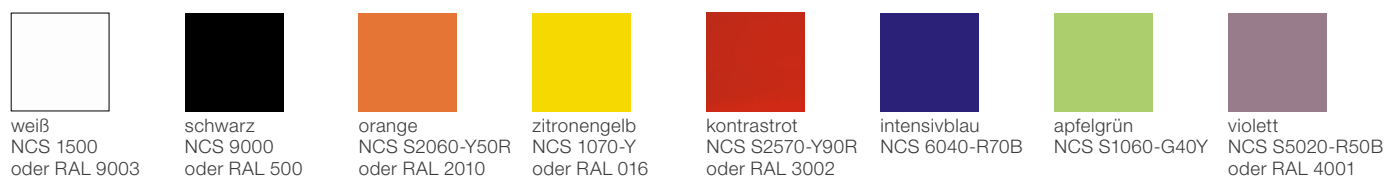

ocker aktiv NCS S 3050-Y40R	lachs aktiv NCS S 4040-Y70R	oxidrot aktiv NCS S 4050-Y90R	steingrau aktiv NCS S 5030-Y90R	sandgrau aktiv NCS S 7010-Y90R
ocker hell NCS S 2030-Y20R	lachs hell NCS S 1515-Y50R	oxidrot hell NCS S 2010-Y80R	steingrau hell NCS S 2502-R	sandgrau hell NCS S 1502-Y
ocker mittel NCS S 3030-Y30R	lachs mittel NCS S 2020-Y50R	oxidrot mittel NCS S 3020-Y80R	steingrau mittel NCS S 3502-R oder RAL 7036	sandgrau mittel NCS S 3005-Y50R
ocker dunkel NCS S 4030-Y50R	lachs dunkel NCS S 3040-Y60R	oxidrot dunkel NCS S 5020-Y80R	steingrau dunkel NCS S 6005-Y80R	sandgrau dunkel NCS S 6010-Y50R
ocker	lachs	oxidrot	steingrau	sandgrau
neutral 3 (asphaltschwarz) NCS S 6500-N	neutral 2 (anthrazit) NCS S 7500-N oder RAL 7015	neutral 1 (tiefschwarz) NCS S 9000-N oder RAL 9017		

Kontrastfarben
(glänzend)

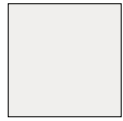

701
neutral 10 (aktivweiß)

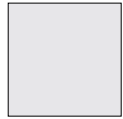

552119
neutral 9 (weißgrau)



552118
neutral 8 (lichtgrau)



552117
neutral 7 (kieselgrau)



552115
neutral 5 (basaltgrau)



552113
neutral 3 (asphaltschwarz)



552112
neutral 2 (anthrazit)



5716
neutral 1 (tiefschwarz)



552004
azur dunkel



552003
azur mittel



552002
azur hell



552001
azur aktiv

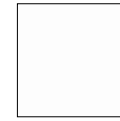

700
weiß



552008
blau dunkel



552007
blau mittel



552006
blau hell



552005
blau aktiv



151
orange



552012
türkis dunkel



552011
türkis mittel



552010
türkis hell



552009
türkis aktiv



154
kontrastrot



552016
grün dunkel



552015
grün mittel



552014
grün hell



552013
grün aktiv



152
apfelgrün



552020
gelb dunkel



552019
gelb mittel



552018
gelb hell



552017
gelb aktiv



717
schwarz



552024
ocker dunkel



552023
ocker mittel



552022
ocker hell



552021
ocker aktiv



150
zitronengelb



552028
lachs dunkel



552027
lachs mittel



552026
lachs hell



552025
lachs aktiv



144
intensivblau



552032
oxidrot dunkel



552031
oxidrot mittel



552030
oxidrot hell



552029
oxidrot aktiv



153
violett



552036
steingrau dunkel



552035
steingrau mittel



552034
steingrau hell



552033
steingrau aktiv



552040
sandgrau dunkel



552039
sandgrau mittel



552038
sandgrau hell



552037
sandgrau aktiv



Boden-/Wandfliese
6,2 x 25 cm, eben

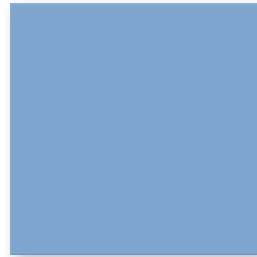

Boden-/Wandfliese
25 x 25 cm, eben

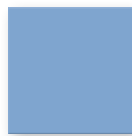

Boden-/Wandfliese
12,5 x 12,5 cm, eben

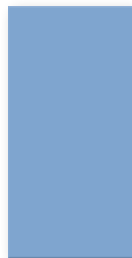

Boden-/Wandfliese
12,5 x 25 cm, eben



Boden-/Wandfliese
25 x 50 cm, eben



Boden-/Wandfliese
12,5 x 50 cm, eben

Boden-/Wandfliesen

6,2 x 25 cm^{3/6}



12,5 x 12,5 cm^{3/6}



12,5 x 25 cm³



12,5 x 50 cm¹

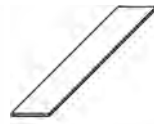

25 x 25 cm³



25 x 50 cm¹

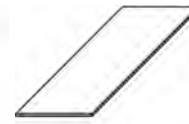

Formatnummer	18210H	12020H	18120H	41550HK	12050H	42550HK	
Nennmaß - cm/in	6,2 x 25 / 2 1/2 x 10	12,5 x 12,5 / 5 x 5	12,5 x 25 / 5 x 10	12,5 x 50 / 5 x 20	25 x 25 / 10 x 10	25 x 50 / 10 x 20	
Herstellmaß	56 x 244 x 6 mm	119 x 119 x 6 mm	119 x 244 x 6 mm	119 x 494 x 8 mm	244 x 244 x 6 mm	244 x 494 x 8 mm	
Oberfläche	eben, seidenmatt ⁵	eben, seidenmatt ⁵	eben, seidenmatt ⁵	eben, seidenmatt ⁵	eben, seidenmatt ⁵	eben, seidenmatt ⁵	
m ² - Stück	64,000	64,000	32,000	16,000	16,000	8,000	
m ² - kg	10,880	12,160	12,160	17,040	12,800	17,040	
Paket - Stück	88	88	44	8	18	9	
Paket - m ²	1,375	1,375	1,375	0,500	1,125	1,125	
Paket - kg	14,960	16,720	16,720	8,520	14,400	19,170	
Palette - m ²	132,000	115,500	115,500	55,000	91,125	40,500	
Palette - kg	1.436,160	1.404,480	1.404,480	937,200	1.166,400	690,120	
Produktnorm	Alb	Alb	Alb	Alb	Alb	Alb	
neutral 10 (aktivweiß glzd.)	4 700i-18210H Preisgr. A157 (m ²)	700i-12020H Preisgr. A157 (m ²)	700i-18120H Preisgr. A94 (m ²)	700i-41550HK Preisgr. A178 (m ²)	700i-12050H Preisgr. A157 (m ²)	700i-42550HK Preisgr. A157 (m ²)	
neutral 10 (aktivweiß matt)	4 701i-18210H Preisgr. A157 (m ²)	701i-12020H Preisgr. A157 (m ²)	701i-18120H Preisgr. A94 (m ²)	701i-41550HK Preisgr. A178 (m ²)	701i-12050H Preisgr. A157 (m ²)	701i-42550HK Preisgr. A157 (m ²)	
neutral 9 (weißgrau)	4 552119-18210H² Preisgr. A217 (m ²)	552119-12020H² Preisgr. A217 (m ²)	552119-18120H Preisgr. A121 (m ²)	552119-41550HK² Preisgr. A235 (m ²)	552119-12050H² Preisgr. A217 (m ²)	552119-42550HK² Preisgr. A217 (m ²)	
neutral 8 (lichtgrau)	4 552118-18210H Preisgr. A187 (m ²)	552118-12020H² Preisgr. A217 (m ²)	552118-18120H Preisgr. A121 (m ²)	552118-41550HK² Preisgr. A235 (m ²)	552118-12050H² Preisgr. A217 (m ²)	552118-42550HK² Preisgr. A217 (m ²)	
neutral 7 (kieselgrau)	4 552117-18210H Preisgr. A187 (m ²)	552117-12020H² Preisgr. A217 (m ²)	552117-18120H Preisgr. A121 (m ²)	552117-41550HK² Preisgr. A235 (m ²)	552117-12050H Preisgr. A187 (m ²)	552117-42550HK² Preisgr. A217 (m ²)	
neutral 5 (basaltgrau)	3 552115-18210H² Preisgr. A217 (m ²)	552115-12020H² Preisgr. A217 (m ²)	552115-18120H² Preisgr. A151 (m ²)	552115-41550HK² Preisgr. A235 (m ²)	552115-12050H² Preisgr. A217 (m ²)	552115-42550HK² Preisgr. A217 (m ²)	
neutral 3 (asphaltschwarz)	3 552113-18210H² Preisgr. A217 (m ²)	552113-12020H² Preisgr. A217 (m ²)	552113-18120H Preisgr. A121 (m ²)	552113-41550HK² Preisgr. A235 (m ²)	552113-12050H² Preisgr. A217 (m ²)	552113-42550HK² Preisgr. A217 (m ²)	
neutral 2 (anthrazit)	2 552112-18210H Preisgr. A187 (m ²)	552112-12020H² Preisgr. A217 (m ²)	552112-18120H Preisgr. A121 (m ²)	552112-41550HK² Preisgr. A235 (m ²)	552112-12050H Preisgr. A187 (m ²)	552112-42550HK Preisgr. A187 (m ²)	
neutral 1 (tiefschwarz)	1 5716i-18210H⁴ Preisgr. A187 (m ²)	5716i-12020H⁴ Preisgr. A187 (m ²)	5716i-18120H⁴ Preisgr. A121 (m ²)	5716-41550HK⁴ Preisgr. A208 (m ²)	5716i-12050H⁴ Preisgr. A187 (m ²)	5716i-42550HK⁴ Preisgr. A187 (m ²)	
azur aktiv	2 552001-18210H Preisgr. A187 (m ²)	552001-12020H Preisgr. A187 (m ²)	552001-18120H Preisgr. A121 (m ²)	552001-41550HK Preisgr. A208 (m ²)	552001-12050H Preisgr. A187 (m ²)	552001-42550HK Preisgr. A187 (m ²)	
azur hell	4 552002-18210H Preisgr. A187 (m ²)	552002-12020H Preisgr. A187 (m ²)	552002-18120H Preisgr. A121 (m ²)	552002-41550HK Preisgr. A208 (m ²)	552002-12050H Preisgr. A187 (m ²)	552002-42550HK Preisgr. A187 (m ²)	
azur mittel	3 552003-18210H Preisgr. A187 (m ²)	552003-12020H Preisgr. A187 (m ²)	552003-18120H Preisgr. A121 (m ²)	552003-41550HK² Preisgr. A235 (m ²)	552003-12050H Preisgr. A187 (m ²)	552003-42550HK Preisgr. A187 (m ²)	
azur dunkel	2 552004-18210H Preisgr. A187 (m ²)	552004-12020H Preisgr. A187 (m ²)	552004-18120H Preisgr. A121 (m ²)	552004-41550HK² Preisgr. A235 (m ²)	552004-12050H² Preisgr. A217 (m ²)	552004-42550HK² Preisgr. A217 (m ²)	
blau aktiv	2 552005-18210H² Preisgr. A217 (m ²)	552005-12020H Preisgr. A187 (m ²)	552005-18120H Preisgr. A121 (m ²)	552005-41550HK² Preisgr. A235 (m ²)	552005-12050H Preisgr. A187 (m ²)	552005-42550HK² Preisgr. A217 (m ²)	
blau hell	4 552006-18210H² Preisgr. A217 (m ²)	552006-12020H Preisgr. A187 (m ²)	552006-18120H Preisgr. A121 (m ²)	552006-41550HK² Preisgr. A235 (m ²)	552006-12050H Preisgr. A187 (m ²)	552006-42550HK Preisgr. A187 (m ²)	
blau mittel	3 552007-18210H Preisgr. A187 (m ²)	552007-12020H Preisgr. A187 (m ²)	552007-18120H Preisgr. A121 (m ²)	552007-41550HK² Preisgr. A235 (m ²)	552007-12050H Preisgr. A187 (m ²)	552007-42550HK Preisgr. A187 (m ²)	
blau dunkel	2 552008-18210H Preisgr. A187 (m ²)	552008-12020H² Preisgr. A217 (m ²)	552008-18120H Preisgr. A121 (m ²)	552008-41550HK² Preisgr. A235 (m ²)	552008-12050H² Preisgr. A217 (m ²)	552008-42550HK² Preisgr. A217 (m ²)	
türkis aktiv	2 552009-18210H Preisgr. A187 (m ²)	552009-12020H² Preisgr. A217 (m ²)	552009-18120H Preisgr. A121 (m ²)	552009-41550HK² Preisgr. A235 (m ²)	552009-12050H² Preisgr. A217 (m ²)	552009-42550HK² Preisgr. A217 (m ²)	
türkis hell	4 552010-18210H Preisgr. A187 (m ²)	552010-12020H Preisgr. A187 (m ²)	552010-18120H Preisgr. A121 (m ²)	552010-41550HK² Preisgr. A235 (m ²)	552010-12050H² Preisgr. A217 (m ²)	552010-42550HK² Preisgr. A217 (m ²)	
türkis mittel	3 552011-18210H Preisgr. A187 (m ²)	552011-12020H Preisgr. A187 (m ²)	552011-18120H Preisgr. A121 (m ²)	552011-41550HK² Preisgr. A235 (m ²)	552011-12050H Preisgr. A187 (m ²)	552011-42550HK² Preisgr. A217 (m ²)	
türkis dunkel	2 552012-18210H⁴ Preisgr. A187 (m ²)	552012-12020H⁴ Preisgr. A187 (m ²)	552012-18120H⁴ Preisgr. A121 (m ²)	552012-41550HK^{2/4} Preisgr. A235 (m ²)	552012-12050H^{2/4} Preisgr. A217 (m ²)	552012-42550HK^{2/4} Preisgr. A217 (m ²)	



³ Überglasierte Kanten / Ecken siehe S. 147
⁴ produktionsbedingte Farbabweichungen zum Standard sind möglich.
⁵ Ausnahme neutral 10 (aktivweiß glzd.): eben, glänzend
⁶ Lieferung als Doppelfliesen; müssen örtlich gebrochen werden.

Boden-/Wandfliesen

6,2 x 25 cm^{3/5}



12,5 x 12,5 cm^{3/5}



12,5 x 25 cm³



12,5 x 50 cm¹



25 x 25 cm³



25 x 50 cm¹



Formatnummer	18210H	12020H	18120H	41550HK	12050H	42550HK
Nennmaß - cm/in	6,2 x 25 / 2 1/2 x 10	12,5 x 12,5 / 5 x 5	12,5 x 25 / 5 x 10	12,5 x 50 / 5 x 20	25 x 25 / 10 x 10	25 x 50 / 10 x 20
Herstellmaß	56 x 244 x 6 mm	119 x 119 x 6 mm	119 x 244 x 6 mm	119 x 494 x 8 mm	244 x 244 x 6 mm	244 x 494 x 8 mm
Oberfläche	eben, seidenmatt	eben, seidenmatt	eben, seidenmatt	eben, seidenmatt	eben, seidenmatt	eben, seidenmatt
m ² - Stück	64,000	64,000	32,000	16,000	16,000	8,000
m ² - kg	10,880	12,160	12,160	17,040	12,800	17,040
Paket - Stück	88	88	44	8	18	9
Paket - m ²	1,375	1,375	1,375	0,500	1,125	1,125
Paket - kg	14,960	16,720	16,720	8,520	14,400	19,170
Palette - m ²	132,000	115,500	115,500	55,000	91,125	40,500
Palette - kg	1.436,160	1.404,480	1.404,480	937,200	1.166,400	690,120
Produktnorm	Alb	Alb	Alb	Alb	Alb	Alb
Beanspruchungsgruppe	2 552013-18210H	552013-12020H	552013-18120H	552013-41550HK²	552013-12050H²	552013-42550HK²
grün aktiv	Preisgr. A187 (m ²)	Preisgr. A187 (m ²)	Preisgr. A121 (m ²)	Preisgr. A235 (m ²)	Preisgr. A217 (m ²)	Preisgr. A217 (m ²)
grün hell	4 552014-18210H	552014-12020H	552014-18120H	552014-41550HK²	552014-12050H	552014-42550HK²
grün hell	Preisgr. A187 (m ²)	Preisgr. A187 (m ²)	Preisgr. A121 (m ²)	Preisgr. A235 (m ²)	Preisgr. A187 (m ²)	Preisgr. A217 (m ²)
grün mittel	3 552015-18210H	552015-12020H	552015-18120H	552015-41550HK²	552015-12050H	552015-42550HK
grün mittel	Preisgr. A187 (m ²)	Preisgr. A187 (m ²)	Preisgr. A121 (m ²)	Preisgr. A235 (m ²)	Preisgr. A187 (m ²)	Preisgr. A187 (m ²)
grün dunkel	2 552016-18210H	552016-12020H	552016-18120H	552016-41550HK²	552016-12050H	552016-42550HK²
grün dunkel	Preisgr. A187 (m ²)	Preisgr. A187 (m ²)	Preisgr. A121 (m ²)	Preisgr. A235 (m ²)	Preisgr. A187 (m ²)	Preisgr. A217 (m ²)
gelb aktiv	2 552017-18210H^{2/4}	552017-12020H^{2/4}	552017-18120H⁴	552017-41550HK^{2/4}	552017-12050H^{2/4}	552017-42550HK^{2/4}
gelb aktiv	Preisgr. A217 (m ²)	Preisgr. A217 (m ²)	Preisgr. A121 (m ²)	Preisgr. A235 (m ²)	Preisgr. A217 (m ²)	Preisgr. A217 (m ²)
gelb hell	4 552018-18210H²	552018-12020H	552018-18120H	552018-41550HK²	552018-12050H	552018-42550HK
gelb hell	Preisgr. A217 (m ²)	Preisgr. A187 (m ²)	Preisgr. A121 (m ²)	Preisgr. A235 (m ²)	Preisgr. A187 (m ²)	Preisgr. A187 (m ²)
gelb mittel	3 552019-18210H	552019-12020H	552019-18120H	552019-41550HK²	552019-12050H	552019-42550HK²
gelb mittel	Preisgr. A187 (m ²)	Preisgr. A187 (m ²)	Preisgr. A121 (m ²)	Preisgr. A235 (m ²)	Preisgr. A187 (m ²)	Preisgr. A217 (m ²)
gelb dunkel	2 552020-18210H⁴	552020-12020H^{2/4}	552020-18120H⁴	552020-41550HK^{2/4}	552020-12050H^{2/4}	552020-42550HK^{2/4}
gelb dunkel	Preisgr. A187 (m ²)	Preisgr. A217 (m ²)	Preisgr. A121 (m ²)	Preisgr. A235 (m ²)	Preisgr. A217 (m ²)	Preisgr. A217 (m ²)
ocker aktiv	2 552021-18210H^{2/4}	552021-12020H^{2/4}	552021-18120H^{2/4}	552021-41550HK^{2/4}	552021-12050H^{2/4}	552021-42550HK^{2/4}
ocker aktiv	Preisgr. A217 (m ²)	Preisgr. A217 (m ²)	Preisgr. A151 (m ²)	Preisgr. A235 (m ²)	Preisgr. A217 (m ²)	Preisgr. A217 (m ²)
ocker hell	4 552022-18210H	552022-12020H²	552022-18120H²	552022-41550HK²	552022-12050H²	552022-42550HK²
ocker hell	Preisgr. A187 (m ²)	Preisgr. A217 (m ²)	Preisgr. A151 (m ²)	Preisgr. A235 (m ²)	Preisgr. A217 (m ²)	Preisgr. A217 (m ²)
ocker mittel	3 552023-18210H²	552023-12020H²	552023-18120H	552023-41550HK²	552023-12050H²	552023-42550HK²
ocker mittel	Preisgr. A217 (m ²)	Preisgr. A217 (m ²)	Preisgr. A121 (m ²)	Preisgr. A235 (m ²)	Preisgr. A217 (m ²)	Preisgr. A217 (m ²)
ocker dunkel	2 552024-18210H²	552024-12020H²	552024-18120H	552024-41550HK²	552024-12050H²	552024-42550HK²
ocker dunkel	Preisgr. A217 (m ²)	Preisgr. A217 (m ²)	Preisgr. A121 (m ²)	Preisgr. A235 (m ²)	Preisgr. A217 (m ²)	Preisgr. A217 (m ²)
lachs aktiv	2 552025-18210H⁴	552025-12020H^{2/4}	552025-18120H^{2/4}	552025-41550HK^{2/4}	552025-12050H^{2/4}	552025-42550HK^{2/4}
lachs aktiv	Preisgr. A187 (m ²)	Preisgr. A217 (m ²)	Preisgr. A151 (m ²)	Preisgr. A235 (m ²)	Preisgr. A217 (m ²)	Preisgr. A217 (m ²)
lachs hell	4 552026-18210H	552026-12020H²	552026-18120H	552026-41550HK²	552026-12050H²	552026-42550HK²
lachs hell	Preisgr. A187 (m ²)	Preisgr. A217 (m ²)	Preisgr. A121 (m ²)	Preisgr. A235 (m ²)	Preisgr. A217 (m ²)	Preisgr. A217 (m ²)
lachs mittel	3 552027-18210H	552027-12020H²	552027-18120H²	552027-41550HK²	552027-12050H	552027-42550HK²
lachs mittel	Preisgr. A187 (m ²)	Preisgr. A217 (m ²)	Preisgr. A151 (m ²)	Preisgr. A235 (m ²)	Preisgr. A187 (m ²)	Preisgr. A217 (m ²)
lachs dunkel	2 552028-18210H²	552028-12020H²	552028-18120H²	552028-41550HK²	552028-12050H²	552028-42550HK²
lachs dunkel	Preisgr. A217 (m ²)	Preisgr. A217 (m ²)	Preisgr. A151 (m ²)	Preisgr. A235 (m ²)	Preisgr. A217 (m ²)	Preisgr. A217 (m ²)
oxidrot aktiv	2 552029-18210H	552029-12020H²	552029-18120H	552029-41550HK²	552029-12050H	552029-42550HK²
oxidrot aktiv	Preisgr. A187 (m ²)	Preisgr. A217 (m ²)	Preisgr. A121 (m ²)	Preisgr. A235 (m ²)	Preisgr. A187 (m ²)	Preisgr. A217 (m ²)
oxidrot hell	4 552030-18210H²	552030-12020H²	552030-18120H²	552030-41550HK²	552030-12050H	552030-42550HK²
oxidrot hell	Preisgr. A217 (m ²)	Preisgr. A217 (m ²)	Preisgr. A151 (m ²)	Preisgr. A235 (m ²)	Preisgr. A187 (m ²)	Preisgr. A217 (m ²)
oxidrot mittel	3 552031-18210H	552031-12020H²	552031-18120H²	552031-41550HK²	552031-12050H	552031-42550HK²
oxidrot mittel	Preisgr. A187 (m ²)	Preisgr. A217 (m ²)	Preisgr. A151 (m ²)	Preisgr. A235 (m ²)	Preisgr. A187 (m ²)	Preisgr. A217 (m ²)
oxidrot dunkel	2 552032-18210H	552032-12020H²	552032-18120H	552032-41550HK²	552032-12050H²	552032-42550HK²
oxidrot dunkel	Preisgr. A187 (m ²)	Preisgr. A217 (m ²)	Preisgr. A121 (m ²)	Preisgr. A235 (m ²)	Preisgr. A217 (m ²)	Preisgr. A217 (m ²)

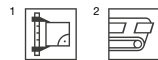

³ Überglasierte Kanten / Ecken siehe S. 149
⁴ produktionsbedingte Farbabweichungen zum Standard sind möglich.
⁵ Lieferung als Doppelfliesen; müssen örtlich gebrochen werden.

Boden-/Wandfliesen

6,2 x 25 cm^{3/4}



12,5 x 12,5 cm^{3/4}



12,5 x 25 cm³



12,5 x 50 cm¹



25 x 25 cm³



25 x 50 cm¹



	18210H	12020H	18120H	41550HK	12050H	42550HK	Beanspruchungsgruppe	Formatnummer
	6,2 x 25 / 2 1/2 x 10	12,5 x 12,5 / 5 x 5	12,5 x 25 / 5 x 10	12,5 x 50 / 5 x 20	25 x 25 / 10 x 10	25 x 50 / 10 x 20		Nennmaß - cm/in
	56 x 244 x 6 mm	119 x 119 x 6 mm	119 x 244 x 6 mm	119 x 494 x 8 mm	244 x 244 x 6 mm	244 x 494 x 8 mm		Herstellmaß
	eben, seidenmatt ⁶	eben, seidenmatt ⁶	eben, seidenmatt ⁶	eben, seidenmatt ⁶	eben, seidenmatt ⁶	eben, seidenmatt ⁶		Oberfläche
	64,000	64,000	32,000	16,000	16,000	8,000		m ² - Stück
	10,880	12,160	12,160	17,040	12,800	17,040		m ² - kg
	88	88	44	8	18	9		Paket - Stück
	1,375	1,375	1,375	0,500	1,125	1,125		Paket - m ²
	14,960	16,720	16,720	8,520	14,400	19,170		Paket - kg
	132,000	115,500	115,500	55,000	91,125	40,500		Palette - m ²
	1.436,160	1.404,480	1.404,480	937,200	1.166,400	690,120		Palette - kg
	Alb	Alb	Alb	Alb	Alb	Alb		Produktnorm
	552033-18210H	552033-12020H²	552033-18120H	552033-41550HK²	552033-12050H²	552033-42550HK²	2	steingrau aktiv <input type="checkbox"/> VO
	Preisgr. A187 (m ²)	Preisgr. A217 (m ²)	Preisgr. A121 (m ²)	Preisgr. A235 (m ²)	Preisgr. A217 (m ²)	Preisgr. A217 (m ²)		
	552034-18210H²	552034-12020H²	552034-18120H²	552034-41550HK²	552034-12050H²	552034-42550HK²	4	steingrau hell <input type="checkbox"/> VO
	Preisgr. A217 (m ²)	Preisgr. A217 (m ²)	Preisgr. A151 (m ²)	Preisgr. A235 (m ²)	Preisgr. A217 (m ²)	Preisgr. A217 (m ²)		
	552035-18210H	552035-12020H	552035-18120H	552035-41550HK²	552035-12050H²	552035-42550HK²	3	steingrau mittel <input type="checkbox"/> VO
	Preisgr. A187 (m ²)	Preisgr. A187 (m ²)	Preisgr. A121 (m ²)	Preisgr. A235 (m ²)	Preisgr. A217 (m ²)	Preisgr. A217 (m ²)		
	552036-18210H²	552036-12020H²	552036-18120H	552036-41550HK²	552036-12050H²	552036-42550HK²	2	steingrau dunkel <input type="checkbox"/> VO
	Preisgr. A217 (m ²)	Preisgr. A217 (m ²)	Preisgr. A121 (m ²)	Preisgr. A235 (m ²)	Preisgr. A217 (m ²)	Preisgr. A217 (m ²)		
	552037-18210H²	552037-12020H²	552037-18120H	552037-41550HK²	552037-12050H²	552037-42550HK²	2	sandgrau aktiv <input type="checkbox"/> VO
	Preisgr. A217 (m ²)	Preisgr. A217 (m ²)	Preisgr. A121 (m ²)	Preisgr. A235 (m ²)	Preisgr. A217 (m ²)	Preisgr. A217 (m ²)		
	552038-18210H	552038-12020H	552038-18120H	552038-41550HK²	552038-12050H	552038-42550HK²	4	sandgrau hell <input type="checkbox"/> VO
	Preisgr. A187 (m ²)	Preisgr. A187 (m ²)	Preisgr. A121 (m ²)	Preisgr. A235 (m ²)	Preisgr. A187 (m ²)	Preisgr. A217 (m ²)		
	552039-18210H²	552039-12020H²	552039-18120H	552039-41550HK²	552039-12050H²	552039-42550HK²	3	sandgrau mittel <input type="checkbox"/> VO
	Preisgr. A217 (m ²)	Preisgr. A217 (m ²)	Preisgr. A121 (m ²)	Preisgr. A235 (m ²)	Preisgr. A217 (m ²)	Preisgr. A217 (m ²)		
	552040-18210H²	552040-12020H²	552040-18120H	552040-41550HK²	552040-12050H²	552040-42550HK	2	sandgrau dunkel <input type="checkbox"/> VO
	Preisgr. A217 (m ²)	Preisgr. A217 (m ²)	Preisgr. A121 (m ²)	Preisgr. A235 (m ²)	Preisgr. A217 (m ²)	Preisgr. A187 (m ²)		
	717i-18210H²	717i-12020H²	717i-18120H²	717i-41550HK²	717i-12050H²	717i-42550HK²	1	schwarz glänzend <input type="checkbox"/> VO
	Preisgr. A217 (m ²)	Preisgr. A217 (m ²)	Preisgr. A151 (m ²)	Preisgr. A235 (m ²)	Preisgr. A217 (m ²)	Preisgr. A217 (m ²)		
	151i-18210H²	151i-12020H²	151i-18120H²	151i-41550HK²	151i-12050H²	151i-42550HK²	1	orange glänzend <input type="checkbox"/> VO
	Preisgr. A217 (m ²)	Preisgr. A217 (m ²)	Preisgr. A151 (m ²)	Preisgr. A235 (m ²)	Preisgr. A217 (m ²)	Preisgr. A217 (m ²)		
	150i-18210H²	150i-12020H²	150i-18120H²	150i-41550HK²	150i-12050H²	150i-42550HK²	2	zitronengelb <input type="checkbox"/> VO
	Preisgr. A217 (m ²)	Preisgr. A217 (m ²)	Preisgr. A151 (m ²)	Preisgr. A235 (m ²)	Preisgr. A217 (m ²)	Preisgr. A217 (m ²)		
	154i-18210H²	154i-12020H²	154i-18120H²	154i-41550HK²	154i-12050H²	154i-42550HK²	1	glänzend <input type="checkbox"/> VO
	Preisgr. A217 (m ²)	Preisgr. A217 (m ²)	Preisgr. A151 (m ²)	Preisgr. A235 (m ²)	Preisgr. A217 (m ²)	Preisgr. A217 (m ²)		
	144-18210^{2/5}	144-12020^{2/5}	144-18120^{2/5}	144-41550K^{2/5}	144-12050^{2/5}	144-42550K^{2/5}	1	kontrastrot <input type="checkbox"/> VO
	Preisgr. A217 (m ²)	Preisgr. A217 (m ²)	Preisgr. A151 (m ²)	Preisgr. A235 (m ²)	Preisgr. A217 (m ²)	Preisgr. A217 (m ²)		
	152i-18210H²	152i-12020H²	152i-18120H²	152i-41550HK²	152i-12050H²	152i-42550HK²	1	glänzend <input type="checkbox"/> VO
	Preisgr. A217 (m ²)	Preisgr. A217 (m ²)	Preisgr. A151 (m ²)	Preisgr. A235 (m ²)	Preisgr. A217 (m ²)	Preisgr. A217 (m ²)		
	153i-18210H²	153i-12020H²	153i-18120H²	153i-41550HK²	153i-12050H²	153i-42550HK²	2	glänzend <input type="checkbox"/> VO
	Preisgr. A217 (m ²)	Preisgr. A217 (m ²)	Preisgr. A151 (m ²)	Preisgr. A235 (m ²)	Preisgr. A217 (m ²)	Preisgr. A217 (m ²)		
	153i-18210H²	153i-12020H²	153i-18120H²	153i-41550HK²	153i-12050H²	153i-42550HK²	1	intensivblau <input type="checkbox"/> VO
	Preisgr. A217 (m ²)	Preisgr. A217 (m ²)	Preisgr. A151 (m ²)	Preisgr. A235 (m ²)	Preisgr. A217 (m ²)	Preisgr. A217 (m ²)		
	152i-18210H²	152i-12020H²	152i-18120H²	152i-41550HK²	152i-12050H²	152i-42550HK²	2	apfelgrün <input type="checkbox"/> VO
	Preisgr. A217 (m ²)	Preisgr. A217 (m ²)	Preisgr. A151 (m ²)	Preisgr. A235 (m ²)	Preisgr. A217 (m ²)	Preisgr. A217 (m ²)		
	153i-18210H²	153i-12020H²	153i-18120H²	153i-41550HK²	153i-12050H²	153i-42550HK²	1	glänzend <input type="checkbox"/> VO
	Preisgr. A217 (m ²)	Preisgr. A217 (m ²)	Preisgr. A151 (m ²)	Preisgr. A235 (m ²)	Preisgr. A217 (m ²)	Preisgr. A217 (m ²)		
	153i-18210H²	153i-12020H²	153i-18120H²	153i-41550HK²	153i-12050H²	153i-42550HK²	1	violett glänzend <input type="checkbox"/> VO
	Preisgr. A217 (m ²)	Preisgr. A217 (m ²)	Preisgr. A151 (m ²)	Preisgr. A235 (m ²)	Preisgr. A217 (m ²)	Preisgr. A217 (m ²)		

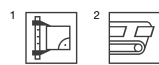

¹ Überglasierte Kanten / Ecken siehe unten

² Lieferung als Doppelfliesen; müssen örtlich gebrochen werden.

³ ohne Hytect-Veredelung

⁴ Ausnahme: Kontrastfarben schwarz, orange, zitronengelb, kontrastrot, intensivblau, apfelgrün, violett: eben, glänzend

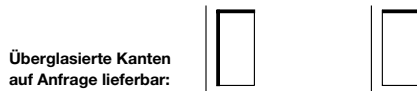

Überglasierte Kanten auf Anfrage lieferbar:

Grundformat-Nr. statt Endziffer 0 Endziffer 3 = Ecke links	... 4 = Ecke rechts	überglasierte Kanten	Beispiel: Grundformat-Nr. 18120 = 119 x 244 x 6 mm, Format-Nr. 18123 = überglasierte Ecke links
---	--------------------	---------------------	----------------------	---



Solebad, Werne, Deutschland / Architekt: Geising + Böker GmbH, Büro Vechta
Foto: Jochen Stüber





Trittsicherheit „B“

-/B



91 weiß / neutral 10 (aktivweiß)



553119 neutral 9 (weißgrau)



553118 neutral 8 (lichtgrau)



553117 neutral 7 (kieselgrau)



553115 neutral 5 (basaltgrau)



553113 neutral 3 (asphaltschwarz)



553112 neutral 2 (anthrazit)



340 schwarz / neutral 1 (tiefschwarz)

-/B



553004 azur dunkel



553008 blau dunkel



553016 grün dunkel



553036 steingrau dunkel



553040 sandgrau dunkel



553003 azur mittel



553007 blau mittel



553011 türkis mittel



553015 grün mittel



553019 gelb mittel



553023 ocker mittel



553027 lachs mittel



553031 oxidrot mittel



553035 steingrau mittel



553039 sandgrau mittel



553002 azur hell



553006 blau hell



553010 türkis hell

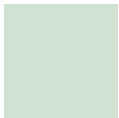

553014 grün hell



553018 gelb hell



553026 lachs hell



553027 lachs hell



553034 steingrau hell



553038 sandgrau hell

-/B



553001 azur aktiv



553033 steingrau aktiv



553037 sandgrau aktiv

-/B



77 kontrastrot



Bodenfliese 12,5 x 12,5 cm, eben, -/B



Bodenfliese 12,5 x 25 cm, eben, -/B



Bodenfliese 25 x 25 cm, eben, -/B

 Auf Anfrage sind weitere Farben der Serie Chroma als non-slip Glasur in 6 mm Fugenbreite lieferbar.

Trittsicherheit „B“

Bodenfliesen²

12,5 x 12,5 cm³



12,5 x 25 cm



25 x 25 cm



	32020H	38110H	32050H	Formatnummer
	12,5 x 12,5 / 5 x 5	12,5 x 25 / 5 x 10	25 x 25 / 10 x 10	Nennmaß - cm/in
	119 x 119 x 8 mm	119 x 244 x 8 mm	244 x 244 x 8 mm	Herstellmaß
	eben, seidenmatt	eben, seidenmatt	eben, seidenmatt	Oberfläche
	64,000	32,000	16,000	m ² - Stück
	15,360	15,680	16,960	m ² - kg
	66	33	14	Paket - Stück
	1,031	1,031	0,875	Paket - m ²
	15,840	16,170	14,840	Paket - kg
	86,625	86,625	70,875	Palette - m ²
	1.330,560	1.358,280	1.202,040	Palette - kg
	Alb	Alb	Alb	Produktnorm
	-/B	-/B	-/B	Trittsicherheit
	2	2	2	Belastung
	91i-32020H	91i-38110H	91i-32050H	neutral 10
	Preisgr. A217 (m ²)	Preisgr. A199 (m ²)	Preisgr. A217 (m ²)	(aktivweiß) <input type="checkbox"/>
	340i-32020H	340i-38110H	340i-32050H	neutral 1
	Preisgr. A217 (m ²)	Preisgr. A199 (m ²)	Preisgr. A217 (m ²)	(tiefschwarz) <input type="checkbox"/>
	553001-32020H	553001-38110H	553001-32050H	azur aktiv <input type="checkbox"/>
	Preisgr. A217 (m ²)	Preisgr. A199 (m ²)	Preisgr. A217 (m ²)	
	553002-32020H	553002-38110H	553002-32050H	azur hell <input type="checkbox"/>
	Preisgr. A217 (m ²)	Preisgr. A199 (m ²)	Preisgr. A217 (m ²)	
	553003-32020H	553003-38110H	553003-32050H	azur mittel <input type="checkbox"/>
	Preisgr. A217 (m ²)	Preisgr. A199 (m ²)	Preisgr. A217 (m ²)	
	553004-32020H	553004-38110H	553004-32050H	azur dunkel <input type="checkbox"/>
	Preisgr. A217 (m ²)	Preisgr. A199 (m ²)	Preisgr. A217 (m ²)	
	553006-32020H	553006-38110H	553006-32050H	blau hell <input type="checkbox"/>
	Preisgr. A217 (m ²)	Preisgr. A199 (m ²)	Preisgr. A217 (m ²)	
	553007-32020H	553007-38110H	553007-32050H	blau mittel <input type="checkbox"/>
	Preisgr. A217 (m ²)	Preisgr. A199 (m ²)	Preisgr. A217 (m ²)	
	553008-32020H	553008-38110H¹	553008-32050H¹	blau dunkel <input type="checkbox"/>
	Preisgr. A217 (m ²)	Preisgr. A199 (m ²)	Preisgr. A217 (m ²)	
	553010-32020H	553010-38110H	553010-32050H¹	türkis hell <input type="checkbox"/>
	Preisgr. A217 (m ²)	Preisgr. A199 (m ²)	Preisgr. A217 (m ²)	
	553011-32020H	553011-38110H	553011-32050H	türkis mittel <input type="checkbox"/>
	Preisgr. A217 (m ²)	Preisgr. A199 (m ²)	Preisgr. A217 (m ²)	
	553014-32020H	553014-38110H¹	553014-32050H¹	grün hell <input type="checkbox"/>
	Preisgr. A217 (m ²)	Preisgr. A199 (m ²)	Preisgr. A217 (m ²)	
	553015-32020H	553015-38110H	553015-32050H	grün mittel <input type="checkbox"/>
	Preisgr. A217 (m ²)	Preisgr. A199 (m ²)	Preisgr. A217 (m ²)	
	553016-32020H	553016-38110H	553016-32050H	grün dunkel <input type="checkbox"/>
	Preisgr. A217 (m ²)	Preisgr. A199 (m ²)	Preisgr. A217 (m ²)	
	553018-32020H¹	553018-38110H¹	553018-32050H¹	gelb hell <input type="checkbox"/>
	Preisgr. A217 (m ²)	Preisgr. A199 (m ²)	Preisgr. A217 (m ²)	
	553019-32020H	553019-38110H	553019-32050H	gelb mittel <input type="checkbox"/>
	Preisgr. A217 (m ²)	Preisgr. A199 (m ²)	Preisgr. A217 (m ²)	
	553023-32020H¹	553023-38110H	553023-32050H	ocker mittel <input type="checkbox"/>
	Preisgr. A217 (m ²)	Preisgr. A199 (m ²)	Preisgr. A217 (m ²)	
	553026-32020H¹	553026-38110H¹	553026-32050H¹	lachs hell <input type="checkbox"/>
	Preisgr. A217 (m ²)	Preisgr. A199 (m ²)	Preisgr. A217 (m ²)	
	553027-32020H¹	553027-38110H	553027-32050H	lachs mittel <input type="checkbox"/>
	Preisgr. A217 (m ²)	Preisgr. A199 (m ²)	Preisgr. A217 (m ²)	
	553031-32020H	553031-38110H¹	553031-32050H¹	oxidrot mittel <input type="checkbox"/>
	Preisgr. A217 (m ²)	Preisgr. A199 (m ²)	Preisgr. A217 (m ²)	
	553033-32020H¹	553033-38110H¹	553033-32050H¹	steingrau aktiv <input type="checkbox"/>
	Preisgr. A217 (m ²)	Preisgr. A199 (m ²)	Preisgr. A217 (m ²)	
	553034-32020H	553034-38110H¹	553034-32050H¹	steingrau hell <input type="checkbox"/>
	Preisgr. A217 (m ²)	Preisgr. A199 (m ²)	Preisgr. A217 (m ²)	
	553035-32020H	553035-38110H	553035-32050H¹	steingrau mittel <input type="checkbox"/>
	Preisgr. A217 (m ²)	Preisgr. A199 (m ²)	Preisgr. A217 (m ²)	
	553036-32020H	553036-38110H	553036-32050H¹	steingrau dunkel <input type="checkbox"/>
	Preisgr. A217 (m ²)	Preisgr. A199 (m ²)	Preisgr. A217 (m ²)	



² Gerundete Kanten / Ecken siehe S. 155

³ Lieferung als Doppelfliesen; müssen örtlich gebrochen werden.

Trittsicherheit „B“

Bodenfliesen²

12,5 x 12,5 cm³



12,5 x 25 cm



25 x 25 cm



Formatnummer	32020H	38110H	32050H			
Nennmaß - cm/in	12,5 x 12,5 / 5 x 5	12,5 x 25 / 5 x 10	25 x 25 / 10 x 10			
Herstellmaß	119 x 119 x 8 mm	119 x 244 x 8 mm	244 x 244 x 8 mm			
Oberfläche	eben, seidenmatt	eben, seidenmatt	eben, seidenmatt			
m ² - Stück	64,000	32,000	16,000			
m ² - kg	15,360	15,680	16,960			
Paket - Stück	66	33	14			
Paket - m ²	1,031	1,031	0,875			
Paket - kg	15,840	16,170	14,840			
Palette - m ²	86,625	86,625	70,875			
Palette - kg	1.330,500	1.358,280	1.202,040			
Produktnorm	Alb	Alb	Alb			
Trittsicherheit	-/B	-/B	-/B			
Belastung	2	2	2			
sandgrau aktiv	553037-32020H ¹ Preisgr. A217 (m ²)	553037-38110H ¹ Preisgr. A199 (m ²)	553037-32050H ¹ Preisgr. A217 (m ²)			
sandgrau hell	553038-32020H Preisgr. A217 (m ²)	553038-38110H Preisgr. A199 (m ²)	553038-32050H ¹ Preisgr. A217 (m ²)			
sandgrau mittel	553039-32020H Preisgr. A217 (m ²)	553039-38110H ¹ Preisgr. A199 (m ²)	553039-32050H ¹ Preisgr. A217 (m ²)			
sandgrau dunkel	553040-32020H Preisgr. A217 (m ²)	553040-38110H ¹ Preisgr. A199 (m ²)	553040-32050H ¹ Preisgr. A217 (m ²)			
neutral 9 (weißgrau)	553119-32020H ¹ Preisgr. A217 (m ²)	553119-38110H ¹ Preisgr. A199 (m ²)	553119-32050H Preisgr. A217 (m ²)			
neutral 8 (lichtgrau)	553118-32020H Preisgr. A217 (m ²)	553118-38110H ¹ Preisgr. A199 (m ²)	553118-32050H Preisgr. A217 (m ²)			
neutral 7 (kieselgrau)	553117-32020H Preisgr. A217 (m ²)	553117-38110H Preisgr. A199 (m ²)	553117-32050H Preisgr. A217 (m ²)			
neutral 5 (basaltgrau)	553115-32020H ¹ Preisgr. A217 (m ²)	553115-38110H ¹ Preisgr. A199 (m ²)	553115-32050H ¹ Preisgr. A217 (m ²)			
neutral 3 (asphaltschwarz)	553113-32020H Preisgr. A217 (m ²)	553113-38110H Preisgr. A199 (m ²)	553113-32050H Preisgr. A217 (m ²)			
neutral 2 (anthrazit)	553112-32020H Preisgr. A217 (m ²)	553112-38110H Preisgr. A199 (m ²)	553112-32050H Preisgr. A217 (m ²)			
kontrastrot	77i-32020H Preisgr. A217 (m ²)	77i-38110H Preisgr. A199 (m ²)	77i-32050H Preisgr. A217 (m ²)			



² Gerundete Kanten / Ecken siehe S. 155

³ Lieferung als Doppelfliesen; müssen örtlich gebrochen werden.

Trittsicherheit „B“ – gerundete Kanten/Ecken^{1/2}

Bodenfliesen

12,5 x 12,5 cm



12,5 x 12,5 cm



12,5 x 25 cm



12,5 x 25 cm



12,5 x 25 cm



12,5 x 25 cm



	gerundete Kante	gerundete Ecke	gerundete Kopfkante	gerundete Längskante	gerundete Ecke links	gerundete Ecke rechts	
	32025H	32027H	38115H	38116H	38117H	38118H	Formatnummer
	12,5 x 12,5 / 5 x 5	12,5 x 12,5 / 5 x 5	12,5 x 25 / 5 x 10	12,5 x 25 / 5 x 10	12,5 x 25 / 5 x 10	12,5 x 25 / 5 x 10	Nennmaß - cm/in
	119 x 119 x 8 mm	119 x 119 x 8 mm	119 x 244 x 8 mm	119 x 244 x 8 mm	119 x 244 x 8 mm	119 x 244 x 8 mm	Herstellmaß
	eben, seidenmatt	eben, seidenmatt	eben, seidenmatt	eben, seidenmatt	eben, seidenmatt	eben, seidenmatt	Oberfläche
							m ² - Stück
	0,240	0,240	0,490	0,490	0,490	0,490	Stück - kg
	66	66	33	33	33	33	Paket - Stück
							Paket - m ²
	15,840	15,840	16,170	16,170	16,170	16,170	Paket - kg
							Palette - m ²
							Palette - kg
	Alb	Alb	Alb	Alb	Alb	Alb	Produktnorm
	-/B	-/B	-/B	-/B	-/B	-/B	Trittsicherheit
	2	2	2	2	2	2	Belastung
	91i-32025H	91i-32027H	91i-38115H	91i-38116H	91i-38117H	91i-38118H	neutral 10
	Preisgr. A410 (St.)	Preisgr. A410 (St.)	Preisgr. A416 (St.)	Preisgr. A416 (St.)	Preisgr. A416 (St.)	Preisgr. A416 (St.)	(aktivweiß) <input type="checkbox"/>
	340i-32025H	340i-32027H	340i-38115H	340i-38116H	340i-38117H	340i-38118H	neutral 1
	Preisgr. A410 (St.)	Preisgr. A410 (St.)	Preisgr. A416 (St.)	Preisgr. A416 (St.)	Preisgr. A416 (St.)	Preisgr. A416 (St.)	(tiefschwarz) <input type="checkbox"/>
	553001-32025H	553001-32027H	553001-38115H	553001-38116H	553001-38117H	553001-38118H	azur aktiv <input type="checkbox"/>
	Preisgr. A410 (St.)	Preisgr. A410 (St.)	Preisgr. A416 (St.)	Preisgr. A416 (St.)	Preisgr. A416 (St.)	Preisgr. A416 (St.)	
	553002-32025H	553002-32027H	553002-38115H	553002-38116H	553002-38117H	553002-38118H	azur hell <input type="checkbox"/>
	Preisgr. A410 (St.)	Preisgr. A410 (St.)	Preisgr. A416 (St.)	Preisgr. A416 (St.)	Preisgr. A416 (St.)	Preisgr. A416 (St.)	



Bodenfliesen



	gerundete Kante	gerundete Ecke	
	32055H	32057H	Formatnummer
	25 x 25 / 10 x 10	25 x 25 / 10 x 10	Nennmaß - cm/in
	244 x 244 x 8 mm	244 x 244 x 8 mm	Herstellmaß
	eben, seidenmatt	eben, seidenmatt	Oberfläche
			m ² - Stück
	1,060	1,060	Stück - kg
	14	14	Paket - Stück
			Paket - m ²
	14,840	14,840	Paket - kg
			Palette - m ²
			Palette - kg
	Alb	Alb	Produktnorm
	-/B	-/B	Trittsicherheit
	2	2	Belastung
	91i-32055H	91i-32057H	neutral 10
	Preisgr. A434 (St.)	Preisgr. A434 (St.)	(aktivweiß) <input type="checkbox"/>
	340i-32055H	340i-32057H	neutral 1
	Preisgr. A434 (St.)	Preisgr. A434 (St.)	(tiefschwarz) <input type="checkbox"/>
	553001-32055H	553001-32057H	azur aktiv <input type="checkbox"/>
	Preisgr. A434 (St.)	Preisgr. A434 (St.)	
	553002-32055H	553002-32057H	azur hell <input type="checkbox"/>
	Preisgr. A434 (St.)	Preisgr. A434 (St.)	



Gerundete Kanten			gerundete Kanten	Beispiel: Grundformat-Nr. 38110 = 119 x 244 x 6 mm, Format-Nr. 38117 = gerundete Ecke links
Grundformat-Nr. statt Endziffer 0 Endziffer 7 = Ecke links	... 8 = Ecke rechts	gerundete Kanten	

Trittsicherheit „C“

-/C

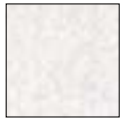

81
weiß / neutral 10 (aktivweiß)



554119
neutral 9 (weißgrau)



554118
neutral 8 (lichtgrau)



554117
neutral 7 (kieselgrau)



554113
neutral 3 (asphaltschwarz)



554111
schwarz / neutral 1 (tiefschwarz)

-/C



554004
azur dunkel



554008
blau dunkel



554016
grün dunkel



554036
steingrau dunkel



554040
sandgrau dunkel



554003
azur mittel



554007
blau mittel



554011
türkis mittel



554015
grün mittel



554019
gelb mittel



554023
ocker mittel



554027
lachs mittel



554031
oxidrot mittel



554035
steingrau mittel



554039
sandgrau mittel



554002
azur hell

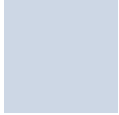

554006
blau hell

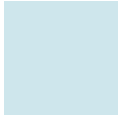

554010
türkis hell



554014
grün hell



554026
lachs hell



554038
sandgrau hell

-/C



554001
azur aktiv

-/C



78
kontrastrot



Bodenfliese
12,5 x 12,5 cm, strukturiert, -/C



Bodenfliese
12,5 x 25 cm, strukturiert, -/C



Bodenfliese
25 x 25 cm, strukturiert, -/C



Auf Anfrage sind weitere Farben der Serie Chroma als non-slip Glasur in 6 mm Fugenbreite lieferbar.

Trittsicherheit „C“
Bodenfliesen²

12,5 x 12,5 cm³



12,5 x 25 cm



25 x 25 cm



32020H	38110H	32050H	Formatnummer
12,5 x 12,5 / 5 x 5	12,5 x 25 / 5 x 10	25 x 25 / 10 x 10	Nennmaß - cm/in
119 x 119 x 8 mm	119 x 244 x 8 mm	244 x 244 x 8 mm	Herstellmaß
strukturiert, seidenmatt	strukturiert, seidenmatt	strukturiert, seidenmatt	Oberfläche
64,000	32,000	16,000	m ² - Stück
15,360	15,680	16,960	m ² - kg
66	33	14	Paket - Stück
1,031	1,031	0,875	Paket - m ²
15,840	16,170	14,840	Paket - kg
86,625	86,625	70,875	Palette - m ²
1.330,560	1.358,280	1.202,040	Palette - kg
Alb	Alb	Alb	Produktnorm
-/C	-/C	-/C	Trittsicherheit
2	2	2	Belastung
81i-32020H	81i-38110H	81i-32050H	neutral 10
Preisgr. A217 (m ²)	Preisgr. A199 (m ²)	Preisgr. A217 (m ²)	(aktivweiß) <input type="checkbox"/>
554111-32020H	554111-38110H	554111-32050H¹	neutral 1
Preisgr. A217 (m ²)	Preisgr. A199 (m ²)	Preisgr. A217 (m ²)	(tiefschwarz) <input type="checkbox"/>
554001-32020H	554001-38110H	554001-32050H¹	azur aktiv <input type="checkbox"/>
Preisgr. A217 (m ²)	Preisgr. A199 (m ²)	Preisgr. A217 (m ²)	
554002-32020H	554002-38110H	554002-32050H	azur hell <input type="checkbox"/>
Preisgr. A217 (m ²)	Preisgr. A199 (m ²)	Preisgr. A217 (m ²)	
554003-32020H	554003-38110H	554003-32050H	azur mittel <input type="checkbox"/>
Preisgr. A217 (m ²)	Preisgr. A199 (m ²)	Preisgr. A217 (m ²)	
554004-32020H	554004-38110H	554004-32050H¹	azur dunkel <input type="checkbox"/>
Preisgr. A217 (m ²)	Preisgr. A199 (m ²)	Preisgr. A217 (m ²)	
554006-32020H	554006-38110H	554006-32050H¹	blau hell <input type="checkbox"/>
Preisgr. A217 (m ²)	Preisgr. A199 (m ²)	Preisgr. A217 (m ²)	
554007-32020H	554007-38110H	554007-32050H¹	blau mittel <input type="checkbox"/>
Preisgr. A217 (m ²)	Preisgr. A199 (m ²)	Preisgr. A217 (m ²)	
554008-32020H	554008-38110H	554008-32050H¹	blau dunkel <input type="checkbox"/>
Preisgr. A217 (m ²)	Preisgr. A199 (m ²)	Preisgr. A217 (m ²)	
554010-32020H	554010-38110H	554010-32050H¹	türkis hell <input type="checkbox"/>
Preisgr. A217 (m ²)	Preisgr. A199 (m ²)	Preisgr. A217 (m ²)	
554011-32020H	554011-38110H	554011-32050H¹	türkis mittel <input type="checkbox"/>
Preisgr. A217 (m ²)	Preisgr. A199 (m ²)	Preisgr. A217 (m ²)	
554014-32020H	554014-38110H¹	554014-32050H¹	grün hell <input type="checkbox"/>
Preisgr. A217 (m ²)	Preisgr. A199 (m ²)	Preisgr. A217 (m ²)	
554015-32020H	554015-38110H¹	554015-32050H¹	grün mittel <input type="checkbox"/>
Preisgr. A217 (m ²)	Preisgr. A199 (m ²)	Preisgr. A217 (m ²)	
554016-32020H	554016-38110H	554016-32050H	grün dunkel <input type="checkbox"/>
Preisgr. A217 (m ²)	Preisgr. A199 (m ²)	Preisgr. A217 (m ²)	
554019-32020H	554019-38110H	554019-32050H¹	gelb mittel <input type="checkbox"/>
Preisgr. A217 (m ²)	Preisgr. A199 (m ²)	Preisgr. A217 (m ²)	
554023-32020H	554023-38110H	554023-32050H	ocker mittel <input type="checkbox"/>
Preisgr. A217 (m ²)	Preisgr. A199 (m ²)	Preisgr. A217 (m ²)	
554026-32020H¹	554026-38110H¹	554026-32050H¹	lachs hell <input type="checkbox"/>
Preisgr. A217 (m ²)	Preisgr. A199 (m ²)	Preisgr. A217 (m ²)	
554027-32020H	554027-38110H	554027-32050H¹	lachs mittel <input type="checkbox"/>
Preisgr. A217 (m ²)	Preisgr. A199 (m ²)	Preisgr. A217 (m ²)	
554031-32020H	554031-38110H	554031-32050H¹	oxidrot mittel <input type="checkbox"/>
Preisgr. A217 (m ²)	Preisgr. A199 (m ²)	Preisgr. A217 (m ²)	
554035-32020H	554035-38110H	554035-32050H¹	steingrau mittel <input type="checkbox"/>
Preisgr. A217 (m ²)	Preisgr. A199 (m ²)	Preisgr. A217 (m ²)	
554036-32020H	554036-38110H	554036-32050H¹	steingrau dunkel <input type="checkbox"/>
Preisgr. A217 (m ²)	Preisgr. A199 (m ²)	Preisgr. A217 (m ²)	
554038-32020H	554038-38110H	554038-32050H	sandgrau hell <input type="checkbox"/>
Preisgr. A217 (m ²)	Preisgr. A199 (m ²)	Preisgr. A217 (m ²)	
554039-32020H	554039-38110H	554039-32050H¹	sandgrau mittel <input type="checkbox"/>
Preisgr. A217 (m ²)	Preisgr. A199 (m ²)	Preisgr. A217 (m ²)	
554040-32020H	554040-38110H	554040-32050H¹	sandgrau dunkel <input type="checkbox"/>
Preisgr. A217 (m ²)	Preisgr. A199 (m ²)	Preisgr. A217 (m ²)	
554119-32020H¹	554119-38110H	554119-32050H¹	neutral 9
Preisgr. A217 (m ²)	Preisgr. A199 (m ²)	Preisgr. A217 (m ²)	(weißgrau) <input type="checkbox"/>
554118-32020H	554118-38110H	554118-32050H¹	neutral 8
Preisgr. A217 (m ²)	Preisgr. A199 (m ²)	Preisgr. A217 (m ²)	(lichtgrau) <input type="checkbox"/>
554117-32020H	554117-38110H	554117-32050H	neutral 7
Preisgr. A217 (m ²)	Preisgr. A199 (m ²)	Preisgr. A217 (m ²)	(kieselgrau) <input type="checkbox"/>
554113-32020H	554113-38110H	554113-32050H	neutral 3
Preisgr. A217 (m ²)	Preisgr. A199 (m ²)	Preisgr. A217 (m ²)	(asphaltschwarz) <input type="checkbox"/>
78i-32020H	78i-38110H	78i-32050H¹	kontrastrot <input type="checkbox"/>
Preisgr. A217 (m ²)	Preisgr. A199 (m ²)	Preisgr. A217 (m ²)	



² Gerundete Kanten / Ecken siehe S. 158

³ Lieferung als Doppelfliesen; müssen örtlich gebrochen werden.



Trittsicherheit „C“ – gerundete Kanten/Ecken^{1/2}

Bodenfliesen

12,5 x 12,5 cm 12,5 x 12,5 cm 12,5 x 25 cm 12,5 x 25 cm 12,5 x 25 cm 12,5 x 25 cm



	gerundete Kante	gerundete Ecke	gerundete Kopfkante	gerundete Längskante	gerundete Ecke links	gerundete Ecke rechts
Formatnummer	32025H	32027H	38115H	38116H	38117H	38118H
Nennmaß - cm/in	12,5 x 12,5 / 5 x 5	12,5 x 12,5 / 5 x 5	12,5 x 25 / 5 x 10	12,5 x 25 / 5 x 10	12,5 x 25 / 5 x 10	12,5 x 25 / 5 x 10
Herstellmaß	119 x 119 x 8 mm	119 x 119 x 8 mm	119 x 244 x 8 mm	119 x 244 x 8 mm	119 x 244 x 8 mm	119 x 244 x 8 mm
Oberfläche	strukturiert, seidenmatt	strukturiert, seidenmatt	strukturiert, seidenmatt	strukturiert, seidenmatt	strukturiert, seidenmatt	strukturiert, seidenmatt
m ² - Stück						
Stück - kg	0,240	0,240	0,490	0,490	0,490	0,490
Paket - Stück	66	66	33	33	33	33
Paket - m ²						
Paket - kg	15,840	15,840	16,170	16,170	16,170	16,170
Palette - m ²						
Palette - kg						
Produktnorm	Alb	Alb	Alb	Alb	Alb	Alb
Trittsicherheit	-/C ☒	-/C ☒	-/C ☒	-/C ☒	-/C ☒	-/C ☒
Belastung	2	2	2	2	2	2
neutral 10	81i-32025H	81i-32027H	81i-38115H	81i-38116H	81i-38117H	81i-38118H
(aktivweiß) <input type="checkbox"/>	Preisgr. A410 (St.)	Preisgr. A410 (St.)	Preisgr. A416 (St.)	Preisgr. A416 (St.)	Preisgr. A416 (St.)	Preisgr. A416 (St.)
neutral 1	554111-32025H	554111-32027H	554111-38115H	554111-38116H	554111-38117H	554111-38118H
(tiefschwarz) <input type="checkbox"/>	Preisgr. A410 (St.)	Preisgr. A410 (St.)	Preisgr. A416 (St.)	Preisgr. A416 (St.)	Preisgr. A416 (St.)	Preisgr. A416 (St.)
azur aktiv	554001-32025H	554001-32027H	554001-38115H	554001-38116H	554001-38117H	554001-38118H
<input type="checkbox"/>	Preisgr. A410 (St.)	Preisgr. A410 (St.)	Preisgr. A416 (St.)	Preisgr. A416 (St.)	Preisgr. A416 (St.)	Preisgr. A416 (St.)
azur hell	554002-32025H	554002-32027H	554002-38115H	554002-38116H	554002-38117H	554002-38118H
<input type="checkbox"/>	Preisgr. A410 (St.)	Preisgr. A410 (St.)	Preisgr. A416 (St.)	Preisgr. A416 (St.)	Preisgr. A416 (St.)	Preisgr. A416 (St.)



25 x 25 cm 25 x 25 cm



	gerundete Kante	gerundete Ecke				
Formatnummer	32055H	32057H				
Nennmaß - cm/in	25 x 25 / 10 x 10	25 x 25 / 10 x 10				
Herstellmaß	244 x 244 x 8 mm	244 x 244 x 8 mm				
Oberfläche	strukturiert, seidenmatt	strukturiert, seidenmatt				
m ² - Stück						
Stück - kg	1,060	1,060				
Paket - Stück	14	14				
Paket - m ²						
Paket - kg	14,840	14,840				
Palette - m ²						
Palette - kg						
Produktnorm	Alb	Alb				
Trittsicherheit	-/C ☒	-/C ☒				
Belastung	2	2				
neutral 10	81i-32055H	81i-32057H				
(aktivweiß) <input type="checkbox"/>	Preisgr. A434 (St.)	Preisgr. A434 (St.)				
neutral 1	554111-32055H	554111-32057H				
(tiefschwarz) <input type="checkbox"/>	Preisgr. A434 (St.)	Preisgr. A434 (St.)				
azur aktiv	554001-32055H	554001-32057H				
<input type="checkbox"/>	Preisgr. A434 (St.)	Preisgr. A434 (St.)				
azur hell	554002-32055H	554002-32057H				
<input type="checkbox"/>	Preisgr. A434 (St.)	Preisgr. A434 (St.)				



Gerundete Kanten



Grundformat-Nr. statt Endziffer 0 Endziffer 7 = Ecke links	... 8 = Ecke rechts	gerundete Kanten	Beispiel: Grundformat-Nr. 38110 = 119 x 244 x 6 mm, Format-Nr. 38117 = gerundete Ecke links
---	--------------------	---------------------	------------------	---



Oasia Hotel, Singapur / Architekt: WOHA Architects + Patricia Urquiola / Serien: Chroma non-slip, Chroma / Foto: Infitude









R10/A R10/B R11/B



Quantum



926
weiß / neutral 10 (aktivweiß)



555023
ocker mittel



Boden-/Wandfliese
12,5 x 12,5 cm, eben, R10/A



555118
neutral 8 (lichtgrau)



555036
steingrau dunkel



555035
steingrau mittel



555117
neutral 7 (kieselgrau)



555040
sandgrau dunkel



555039
sandgrau mittel



555038
sandgrau hell

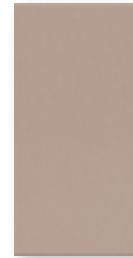

Boden-/Wandfliese
12,5 x 25 cm, eben, R10/A



555113
neutral 3 (asphaltschwarz)



918
schwarz / neutral 1 (tiefschwarz)

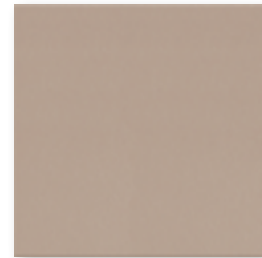

Boden-/Wandfliese
25 x 25 cm, eben, R10/A



901
naturweiß



Boden-/Wandfliese
25 x 50 cm, eben, R10/A

Rasterprofil



Rasterprofilfliese
12,5 x 12,5 cm, reliefiert, R11/B



Rasterprofilfliese
12,5 x 25 cm, reliefiert, R11/B

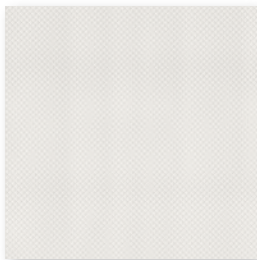

Rasterprofilfliese
25 x 25 cm, reliefiert, R11/B

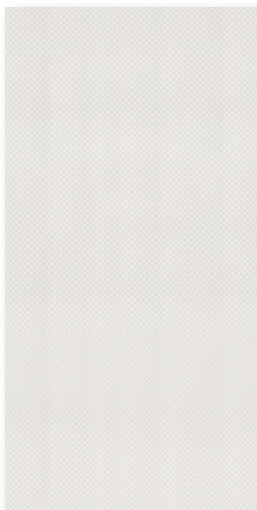

Rasterprofilfliese
25 x 50 cm, reliefiert, R11/B

Duschtassensystem

Duschtassensystem
Ecke (einteilig)
12,5 x 12,5 cm, eben, R10/B



Duschtassensystem
Läufer
12,5 x 12,5 cm
eben, R10/B

Duschtassensystem
Läufer
25 x 12,5 cm
eben, R10/B

Hohlkehlssockel, r = 12 mm
25 x 12,5 cm, eben



Außenecke,
eben

Innenecke,
eben

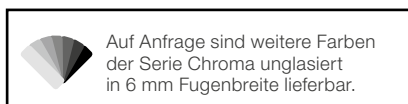

Auf Anfrage sind weitere Farben
der Serie Chroma unglasiert
in 6 mm Fugenbreite lieferbar.

Quantum

Boden-/Wandfliesen

12,5 x 12,5 cm³



12,5 x 25 cm



25 x 25 cm



25 x 50 cm^{1/2/4}

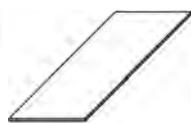

Formatnummer	32020H	38110H	32050H	42550HK			
Nennmaß - cm/in	12,5 x 12,5 / 5 x 5	12,5 x 25 / 5 x 10	25 x 25 / 10 x 10	25 x 50 / 10 x 20			
Herstellmaß	119 x 119 x 8 mm	119 x 244 x 8 mm	244 x 244 x 8 mm	244 x 494 x 8 mm			
Oberfläche	eben, seidenmatt	eben, seidenmatt	eben, seidenmatt	eben, seidenmatt			
m ² - Stück	64,000	32,000	16,000	8,000			
m ² - kg	15,360	15,680	16,960	17,040			
Paket - Stück	66	33	14	9			
Paket - m ²	1,031	1,031	0,875	1,125			
Paket - kg	15,840	16,170	14,840	19,170			
Palette - m ²	86,625	86,625	70,875	40,500			
Palette - kg	1.330,560	1.358,280	1.202,040	690,120			
Produktnorm	Alb	Alb	Alb	Alb			
Trittsicherheit	R10/A	R10/A	R10/A	R10/A			
Belastung	2	2	2	2			
neutral 10	926i-32020H	926i-38110H	926i-32050H	926i-42550HK			
(aktivweiß) <input type="checkbox"/>	Preisgr. A166 (m ²)	Preisgr. A166 (m ²)	Preisgr. A166 (m ²)	Preisgr. A178 (m ²)			
neutral 1	918i-32020H	918i-38110H	918i-32050H	918i-42550HK			
(tiefschwarz) <input type="checkbox"/>	Preisgr. A166 (m ²)	Preisgr. A166 (m ²)	Preisgr. A166 (m ²)	Preisgr. A178 (m ²)			
ocker mittel	555023-32020H ^{2/4}	555023-38110H ^{2/4}	555023-32050H ^{2/4}	555023-42550HK			
<input type="checkbox"/>	Preisgr. A166 (m ²)	Preisgr. A166 (m ²)	Preisgr. A166 (m ²)	Preisgr. A178 (m ²)			
steingrau mittel	555035-32020H ^{2/4}	555035-38110H ^{2/4}	555035-32050H ^{2/4}	555035-42550HK			
<input type="checkbox"/>	Preisgr. A166 (m ²)	Preisgr. A166 (m ²)	Preisgr. A166 (m ²)	Preisgr. A178 (m ²)			
steingrau dunkel	555036-32020H ^{2/4}	555036-38110H ^{2/4}	555036-32050H ^{2/4}	555036-42550HK			
<input type="checkbox"/>	Preisgr. A166 (m ²)	Preisgr. A166 (m ²)	Preisgr. A166 (m ²)	Preisgr. A178 (m ²)			
sandgrau hell	555038-32020H ^{2/4}	555038-38110H ^{2/4}	555038-32050H ^{2/4}	555038-42550HK			
<input type="checkbox"/>	Preisgr. A166 (m ²)	Preisgr. A166 (m ²)	Preisgr. A166 (m ²)	Preisgr. A178 (m ²)			
sandgrau mittel	555039-32020H ^{2/4}	555039-38110H ^{2/4}	555039-32050H ^{2/4}	555039-42550HK			
<input type="checkbox"/>	Preisgr. A166 (m ²)	Preisgr. A166 (m ²)	Preisgr. A166 (m ²)	Preisgr. A178 (m ²)			
sandgrau dunkel	555040-32020H ^{2/4}	555040-38110H ^{2/4}	555040-32050H ^{2/4}	555040-42550HK			
<input type="checkbox"/>	Preisgr. A166 (m ²)	Preisgr. A166 (m ²)	Preisgr. A166 (m ²)	Preisgr. A178 (m ²)			
neutral 3	555113-32020H ^{2/4}	555113-38110H ^{2/4}	555113-32050H ^{2/4}	555113-42550HK			
(asphaltschwarz) <input type="checkbox"/>	Preisgr. A166 (m ²)	Preisgr. A166 (m ²)	Preisgr. A166 (m ²)	Preisgr. A178 (m ²)			
neutral 7	555117-32020H ^{2/4}	555117-38110H ^{2/4}	555117-32050H ^{2/4}	555117-42550HK			
(kieselgrau) <input type="checkbox"/>	Preisgr. A166 (m ²)	Preisgr. A166 (m ²)	Preisgr. A166 (m ²)	Preisgr. A178 (m ²)			
neutral 8	555118-32020H ^{2/4}	555118-38110H ^{2/4}	555118-32050H ^{2/4}	555118-42550HK			
(lichtgrau) <input type="checkbox"/>	Preisgr. A166 (m ²)	Preisgr. A166 (m ²)	Preisgr. A166 (m ²)	Preisgr. A178 (m ²)			
naturweiß	901i-32020H	901i-38110H	901i-32050H	901i-42550HK			
<input type="checkbox"/>	Preisgr. A166 (m ²)	Preisgr. A166 (m ²)	Preisgr. A166 (m ²)	Preisgr. A178 (m ²)			



³ Lieferung als Doppelfliesen; müssen örtlich gebrochen werden.

⁴ Mindestmenge: 200 m²

Quantum

Bodenfliesen

12,5 x 12,5 cm³



12,5 x 25 cm



25 x 25 cm



25 x 50 cm^{1/2/4}



			Rasterprofilfliese	Rasterprofilfliese	Rasterprofilfliese	Rasterprofilfliese	
			32100H	34090H	32080H	42580HK	Formatnummer
			12,5 x 12,5 / 5 x 5	12,5 x 25 / 5 x 10	25 x 25 / 10 x 10	25 x 50 / 10 x 20	Nennmaß - cm/in
			119 x 119 x 8 mm	119 x 244 x 8 mm	244 x 244 x 8 mm	244 x 494 x 8 mm	Herstellmaß
			reliefiert, seidenmatt	reliefiert, seidenmatt	reliefiert, seidenmatt	reliefiert, seidenmatt	Oberfläche
			64,000	32,000	16,000	8,000	m ² - Stück
			15,360	15,360	16,800	17,040	m ² - kg
			66	33	14	9	Paket - Stück
			1,031	1,031	0,875	1,125	Paket - m ²
			15,840	15,840	14,700	19,170	Paket - kg
			86,625	86,625	70,875	40,500	Palette - m ²
			1.330,560	1.330,560	1.190,700	690,120	Palette - kg
			Alb	Alb	Alb	Alb	Produktnorm
			R11/B	R11/B	R11/B	R11/B	Trittsicherheit
			2	2	2	2	Belastung
			926i-32100H	926i-34090H	926i-32080H	926i-42580HK	neutral 10
			Preisgr. A178 (m ²)	Preisgr. A178 (m ²)	Preisgr. A178 (m ²)	Preisgr. A196 (m ²)	(aktivweiß) <input type="checkbox"/>
			918i-32100H	918i-34090H	918i-32080H	918i-42580HK	neutral 1
			Preisgr. A178 (m ²)	Preisgr. A178 (m ²)	Preisgr. A178 (m ²)	Preisgr. A196 (m ²)	(tiefschwarz) <input type="checkbox"/>
			555023-32100H ^{2/4}	555023-34090H ^{2/4}	555023-32080H ^{2/4}	555023-42580HK	
			Preisgr. A178 (m ²)	Preisgr. A178 (m ²)	Preisgr. A178 (m ²)	Preisgr. A196 (m ²)	ocker mittel <input type="checkbox"/>
			555035-32100H ^{2/4}	555035-34090H ^{2/4}	555035-32080H ^{2/4}	555035-42580HK	
			Preisgr. A178 (m ²)	Preisgr. A178 (m ²)	Preisgr. A178 (m ²)	Preisgr. A196 (m ²)	steingrau mittel <input type="checkbox"/>
			555036-32100H ^{2/4}	555036-34090H ^{2/4}	555036-32080H ^{2/4}	555036-42580HK	
			Preisgr. A178 (m ²)	Preisgr. A178 (m ²)	Preisgr. A178 (m ²)	Preisgr. A196 (m ²)	steingrau dunkel <input type="checkbox"/>
			555038-32100H ^{2/4}	555038-34090H ^{2/4}	555038-32080H ^{2/4}	555038-42580HK	
			Preisgr. A178 (m ²)	Preisgr. A178 (m ²)	Preisgr. A178 (m ²)	Preisgr. A196 (m ²)	sandgrau hell <input type="checkbox"/>
			555039-32100H ^{2/4}	555039-34090H ^{2/4}	555039-32080H ^{2/4}	555039-42580HK	
			Preisgr. A178 (m ²)	Preisgr. A178 (m ²)	Preisgr. A178 (m ²)	Preisgr. A196 (m ²)	sandgrau mittel <input type="checkbox"/>
			555040-32100H ^{2/4}	555040-34090H ^{2/4}	555040-32080H ^{2/4}	555040-42580HK	
			Preisgr. A178 (m ²)	Preisgr. A178 (m ²)	Preisgr. A178 (m ²)	Preisgr. A196 (m ²)	sandgrau dunkel <input type="checkbox"/>
			555113-32100H ^{2/4}	555113-34090H ^{2/4}	555113-32080H ^{2/4}	555113-42580HK	
			Preisgr. A178 (m ²)	Preisgr. A178 (m ²)	Preisgr. A178 (m ²)	Preisgr. A196 (m ²)	neutral 3
			555117-32100H ^{2/4}	555117-34090H ^{2/4}	555117-32080H ^{2/4}	555117-42580HK	(asphaltschwarz) <input type="checkbox"/>
			Preisgr. A178 (m ²)	Preisgr. A178 (m ²)	Preisgr. A178 (m ²)	Preisgr. A196 (m ²)	neutral 7
			555118-32100H ^{2/4}	555118-34090H ^{2/4}	555118-32080H ^{2/4}	555118-42580HK	(kieselgrau) <input type="checkbox"/>
			Preisgr. A178 (m ²)	Preisgr. A178 (m ²)	Preisgr. A178 (m ²)	Preisgr. A196 (m ²)	neutral 8
			901i-32100H	901i-34090H	901i-32080H	901i-42580HK	(lichtgrau) <input type="checkbox"/>
			Preisgr. A178 (m ²)	Preisgr. A178 (m ²)	Preisgr. A178 (m ²)	Preisgr. A196 (m ²)	naturweiß <input type="checkbox"/>

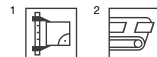

³ Lieferung als Doppelfliesen; müssen örtlich gebrochen werden.

⁴ Mindestmenge: 200 m²



Quantum

Duschtassensystem²

12,5 x 25 cm



12,5 x 12,5 cm



12,5 x 12,5 cm



Schwallkante 10 mm
Läufer

Schwallkante 10 mm
Läufer

Ecke

Formatnummer	27182H	27180H	27181H
Nennmaß - cm/in	12,5 x 25 / 5 x 10	12,5 x 12,5 / 5 x 5	12,5 x 12,5 / 5 x 5
Herstellmaß	119 x 244 x 18/8 mm	119 x 119 x 18/8 mm	119 x 119 x 18/8 mm
Oberfläche	eben, seidenmatt	eben, seidenmatt	eben, seidenmatt
m - Stück	4,000	8,000	
m/St. - kg	2,720/m	2,720/m	0,500/Stück
Paket - Stück	22	44	12
Paket - m	5,500	5,500	
Paket - kg	14,960	14,960	6,000
Palette - m			
Palette - kg			
Produktnorm	Alb	Alb	Alb
Trittsicherheit	R10/B	R10/B	R10/B
neutral 10	926i-27182H	926i-27180H	926i-27181H
(aktivweiß) <input type="checkbox"/>	Preisgr. A506 (St.)	Preisgr. A455 (St.)	Preisgr. A489 (St.)
neutral 1	918i-27182H	918i-27180H	918i-27181H
(tiefschwarz) <input type="checkbox"/>	Preisgr. A506 (St.)	Preisgr. A455 (St.)	Preisgr. A489 (St.)
ocker mittel	555023-27182H ¹	555023-27180H ¹	555023-27181H ¹
<input type="checkbox"/>	Preisgr. A506 (St.)	Preisgr. A455 (St.)	Preisgr. A489 (St.)
steingrau mittel	555035-27182H ¹	555035-27180H ¹	555035-27181H ¹
<input type="checkbox"/>	Preisgr. A506 (St.)	Preisgr. A455 (St.)	Preisgr. A489 (St.)
steingrau dunkel	555036-27182H ¹	555036-27180H ¹	555036-27181H ¹
<input type="checkbox"/>	Preisgr. A506 (St.)	Preisgr. A455 (St.)	Preisgr. A489 (St.)
sandgrau hell	555038-27182H ¹	555038-27180H ¹	555038-27181H ¹
<input type="checkbox"/>	Preisgr. A506 (St.)	Preisgr. A455 (St.)	Preisgr. A489 (St.)
sandgrau mittel	555039-27182H ¹	555039-27180H ¹	555039-27181H ¹
<input type="checkbox"/>	Preisgr. A506 (St.)	Preisgr. A455 (St.)	Preisgr. A489 (St.)
sandgrau dunkel	555040-27182H ¹	555040-27180H ¹	555040-27181H ¹
<input type="checkbox"/>	Preisgr. A506 (St.)	Preisgr. A455 (St.)	Preisgr. A489 (St.)
neutral 3	555113-27182H ¹	555113-27180H ¹	555113-27181H ¹
(asphaltschwarz) <input type="checkbox"/>	Preisgr. A506 (St.)	Preisgr. A455 (St.)	Preisgr. A489 (St.)
neutral 7	555117-27182H ¹	555117-27180H ¹	555117-27181H ¹
(kieselgrau) <input type="checkbox"/>	Preisgr. A506 (St.)	Preisgr. A455 (St.)	Preisgr. A489 (St.)
neutral 8	555118-27182H ¹	555118-27180H ¹	555118-27181H ¹
(lichtgrau) <input type="checkbox"/>	Preisgr. A506 (St.)	Preisgr. A455 (St.)	Preisgr. A489 (St.)
naturweiß <input type="checkbox"/>	901i-27182H	901i-27180H	901i-27181H
	Preisgr. A506 (St.)	Preisgr. A455 (St.)	Preisgr. A489 (St.)



² Details siehe S. 535

Quantum

Sicherheitsriemchen^{1/2}

6,2 x 25 cm



Längskante
gerundet

Sockelsysteme¹

7,9 x 25 cm



12,5 x 25 cm



Hohlkehlsockel,
r = 12 mm

Außenecke
Gehrungspaar

Innenecke
Gehrungspaar

	Längskante gerundet	Sockelleiste	Hohlkehlsockel, r = 12 mm	Außenecke Gehrungspaar	Innenecke Gehrungspaar	
	34306H	34020H	37080	37081	37082	Formatnummer
	6,2 x 25 / 2 1/2 x 10	7,9 x 25 / 3 1/8 x 10	12,5 x 25 / 5 x 10			Nennmaß - cm/in
	56 x 244 x 8 mm	73 x 244 x 8 mm	125 x 244/12 x 8 mm	(2x) 131 x 125/12 x 8 mm	(2x) 119 x 125/12 x 8 mm	Herstellmaß
	gerillt, seidenmatt	eben, seidenmatt	eben, seidenmatt	eben, seidenmatt	eben, seidenmatt	Oberfläche
	4,000	4,000	4,000			m - Stück
	0,800/m	1,160/m	2,520/m	0,600/Paar	0,400/Paar	m/Paar - kg
	66 Stück	33 Stück	20 Stück	10 Paar	10 Paar	Paket - St./Paar
	16,500	8,250	5,000			Paket - m
	13,200	9,570	12,600	6,000	4,000	Paket - kg
						Palette - m
						Palette - kg
	Alb	Alb	Alb	Alb	Alb	Produktnorm
	-/C		R10/A	R10/A	R10/A	Trittsicherheit
		926i-34020H	926-37080	926-37081	926-37082	neutral 10
		Preisgr. A410 (St.)	Preisgr. A423 (St.)	Preisgr. A455 (Paar)	Preisgr. A455 (Paar)	(aktivweiß) <input type="checkbox"/> VQ
		918i-34020H	918-37080	918-37081	918-37082	neutral 1
		Preisgr. A410 (St.)	Preisgr. A423 (St.)	Preisgr. A455 (Paar)	Preisgr. A455 (Paar)	(tiefschwarz) <input type="checkbox"/> VQ
		901i-34020H	901-37080	901-37081	901-37082	naturweiß <input type="checkbox"/> VQ
		Preisgr. A410 (St.)	Preisgr. A423 (St.)	Preisgr. A455 (Paar)	Preisgr. A455 (Paar)	



² Besonders geeignet zur trittsicheren und deutlich wahrnehmbaren Gestaltung von (Treppen-)Kanten.







Harmonisches Wohngefühl

Die Serie Concrete schafft mit ihren Wandfliesen, in den Farben silbergrau und sandbeige ein natürliches und harmonisches Wohnambiente. Mit den Mosaikfliesen Screen und Stripes in graphit und sandbeige und den passenden Bordüren lassen sich stimmige Akzente setzen. Die Wandfliesen sind durch ihre Hytect-Oberfläche reinigungsfreundlich.

Studioaufnahme

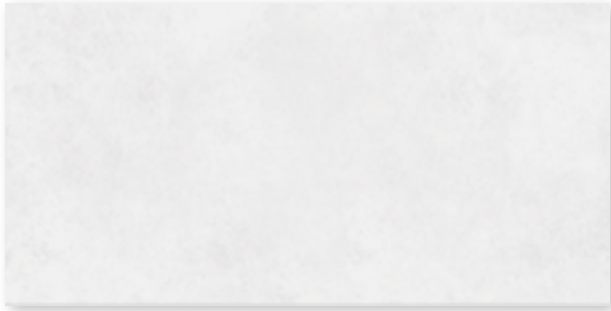

Wandfliese 30 x 60 cm, silbergrau, strukturiert



Wandfliese 30 x 60 cm, sandbeige, strukturiert

Dekorationselemente



Mosaikfliese Stripes 30 x 60 cm, anthrazit, strukturiert



Mosaikfliese Stripes 30 x 60 cm, sandbeige, strukturiert



Mosaikfliese Screen 30 x 60 cm, anthrazit, strukturiert



Mosaikfliese Screen 30 x 60 cm, sandbeige, strukturiert



Bordüre Stripes 8 x 60 cm, anthrazit, strukturiert

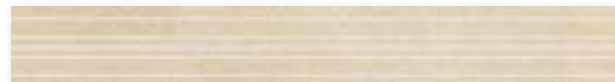

Bordüre Stripes 8 x 60 cm, sandbeige, strukturiert

Wandfliese² Dekorationselemente^{1/3}

30 x 60 cm



30 x 60 cm



30 x 60 cm⁴

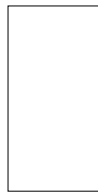

30 x 60 cm

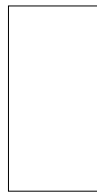

30 x 60 cm⁴



8 x 60 cm



8 x 60 cm⁴



	Mosaikfliese Stripes	Mosaikfliese Stripes	Mosaikfliese Screen	Mosaikfliese Screen	Bordüre Stripes	Bordüre Stripes	
30 x 60 / 12 x 24	30 x 60 / 12 x 24	30 x 60 / 12 x 24	30 x 60 / 12 x 24	30 x 60 / 12 x 24	8 x 60 / 3 3/16 x 24	8 x 60 / 3 3/16 x 24	Nennmaß - cm/in
296 x 595 x 9 mm	297 x 597 x 10,5 mm	296 x 595 x 10 mm	297 x 597 x 10,5 mm	296 x 595 x 10 mm	80 x 597 x 10,5 mm	80 x 595 x 10 mm	Herstellmaß
strukturiert, seidenmatt	strukturiert, matt	strukturiert, matt	strukturiert, matt	strukturiert, matt	strukturiert, matt	strukturiert, matt	Oberfläche
5,556/m ²	1,667/m	1,667/m	1,667/m	1,667/m	1,667/m	1,667/m	m ² /m - Stück
14,946/m ²	6,668/m	6,668/m	6,668/m	6,668/m	1,779/m	1,779/m	m ² /m - kg
9	2	2	2	2	4	4	Paket - Stück
1,620 m ²	1,200 m	1,200 m	1,200 m	1,200 m	2,400 m	2,400 m	Paket - m ² /m
24,210	8,000	8,000	8,000	8,000	4,268	4,268	Paket - kg
77,754							Palette - m ²
1.162,080							Palette - kg
BIII	Bla	Bla	Bla	Bla	Bla	Bla	Produktnorm
280345							silbergrau <input type="checkbox"/> V2
Preisgr. C56 (m ²)							sandbeige <input type="checkbox"/> V2
280354		280360		280362		280361	anthrazit <input type="checkbox"/> V2
Preisgr. C56 (m ²)		Preisgr. C486 (St.)		Preisgr. C491 (St.)		Preisgr. C447 (St.)	
	280349-73		280351-73		280350-73		
	Preisgr. C486 (St.)		Preisgr. C491 (St.)		Preisgr. C447 (St.)		



¹ nicht frostsicher

² Abgabe der Dekorationselemente ausschließlich in vollen Kartons.

³ ohne Hytect-Veredelung





Inspirierend und modern

Der seit Jahren anhaltende Heritage Hype in Mode, Lifestyle und Technik geht auch an Fliesen nicht vorüber. Craft zitiert Vertrautes und wirkt doch überraschend modern: Die für Innen- und Außenbereiche gleichermaßen geeignete Serie verdankt ihren handwerklichen Charakter der Tiefe und Transparenz ihrer hochglänzenden Glasur. Kompositionen von Erdalkalien, Flussmitteln und Metalloxiden im Zusammenspiel mit dem Tonkörper lassen bei offener Flammführung besonders leuchtende, intensive Kolorationen und die typischen Oberflächenstrukturen entstehen.

Bar Bardem, Helsinki, Finnland / Architekt: Fyra Ltd.
Foto: Riikka Kantinkoski

Unifarben

Geflamnte Farben

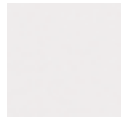

reinweiß



weiß

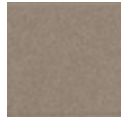

mittelgrau



dunkelgrau

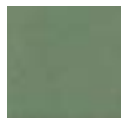

jadegrün

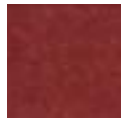

beryllrot

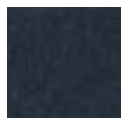

benitblau

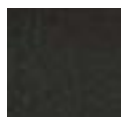

hämatitschwarz



olivgrün geflamnt



goldgelb geflamnt



amber geflamnt



blaugrün geflamnt

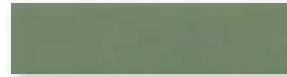

Riemchen 6,2 x 25 cm, eben



Riemchen Wellenprofil 6,2 x 25 cm, profiliert



Riemchen Rillenprofil 6,2 x 25 cm, profiliert



Riemchen Spitzprofil 6,2 x 25 cm, profiliert



Doppelspitzplatte 12,5 x 25 cm, profiliert

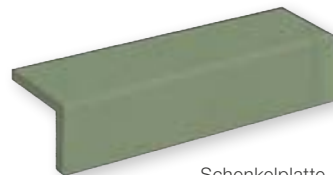

Schenkelplatte
6,2 x 25 cm, eben



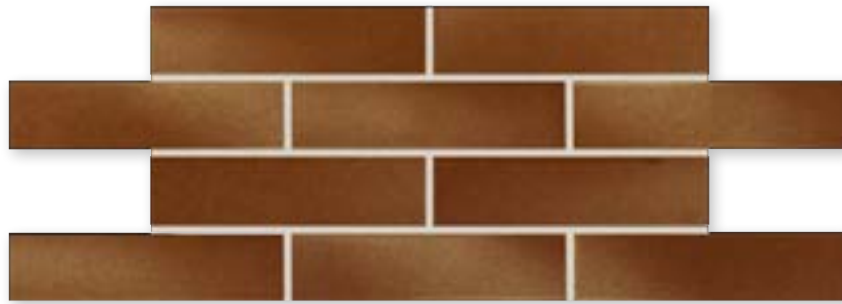

Riemchen 6,2 x 25 cm

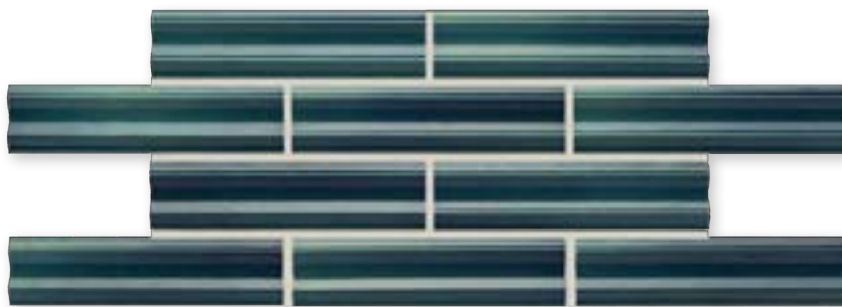

Riemchen Wellenprofil 6,2 x 25 cm



Doppelspitzplatte 12,5 x 25 cm



Riemchen Spitzprofil 6,2 x 25 cm



Riemchen Rillenprofil 6,2 x 25 cm

Riemchen²

Doppelspitzplatte

Schenkelplatte, **NEU** geklebt^{1/4}

6,2 x 25 cm



6,2 x 25 cm



6,2 x 25 cm⁵



6,2 x 25 cm



12,5 x 25 cm



6,2 x 25 cm



Wellenprofil

Spitzprofil asym.

Rillenprofil (A&B Seite)

	2120	2250	2270	2280	2240	2821	Formatnummer
	6,2 x 25 / 2 1/2 x 10	6,2 x 25 / 2 1/2 x 10	6,2 x 25 / 2 1/2 x 10	6,2 x 25 / 2 1/2 x 10	12,5 x 25 / 5 x 10	6,2 x 25 / 2 1/2 x 10	Nennmaß - cm/in
	52 x 240 x 11 mm	52 x 240 x 16/11 mm	52 x 240 x 18/11 mm	52 x 240 x 11 mm	115 x 240 x 20/11 mm	52 x 52 x 240 x 11 mm	Herstellmaß
	eben, glänzend	profiliert, glänzend	profiliert, glänzend	profiliert, glänzend	profiliert, glänzend	eben, glänzend	Oberfläche
	67,000/m ²	67,000/m ²	67,000/m ²	67,000/m ²	33,000/m ²	4,000/m	m ² - Stück
	20,100/m ²	21,775/m ²	27,470/m ²	21,440/m ²	27,060/m ²	2,400/m	m ² - kg
	46	34	30	44	14		Paket - Stück
	0,687	0,507	0,448	0,657	0,209		Paket - m ²
	13,800	11,050	12,300	14,080	11,480		Paket - kg
	57,678	42,627	37,612	55,164	35,636		Palette - m ²
	1.159,200	928,200	1.033,200	1.182,720	964,320		Palette - kg
	Alla	Alla	Alla	Alla	Alla	Alla	Produktnorm
							Trittsicherheit
							Belastung
	9027-2120H	9027-2250H	9027-2270H	9027-2280H	9027-2240H	<i>9027-2821H</i>	reinweiß <input type="checkbox"/> V1
	Preisgr. A187 (m ²)	Preisgr. A253 (m ²)	Preisgr. A253 (m ²)	Preisgr. A253 (m ²)	Preisgr. A268 (m ²)		
	9026-2120H	9026-2250H	9026-2270H	9026-2280H	9026-2240H	<i>9026-2821H</i>	weiß <input type="checkbox"/> V1
	Preisgr. A187 (m ²)	Preisgr. A253 (m ²)	Preisgr. A253 (m ²)	Preisgr. A253 (m ²)	Preisgr. A268 (m ²)		
	9022-2120H	9022-2250H	9022-2270H	9022-2280H	9022-2240H	<i>9022-2821H</i>	mittelgrau <input type="checkbox"/> V1
	Preisgr. A187 (m ²)	Preisgr. A253 (m ²)	Preisgr. A253 (m ²)	Preisgr. A253 (m ²)	Preisgr. A268 (m ²)		
	9021-2120H	<i>9021-2250H^{1/3}</i>	<i>9021-2270H^{1/3}</i>	<i>9021-2280H^{1/3}</i>	<i>9021-2240H^{1/3}</i>	<i>9021-2821H</i>	dunkelgrau <input type="checkbox"/> V1
	Preisgr. A187 (m ²)	Preisgr. A253 (m ²)	Preisgr. A253 (m ²)	Preisgr. A253 (m ²)	Preisgr. A268 (m ²)		
	9020-2120H	9020-2250H	9020-2270H	9020-2280H	9020-2240H	<i>9020-2821H</i>	olivgrün <input type="checkbox"/> V2
	Preisgr. A187 (m ²)	Preisgr. A253 (m ²)	Preisgr. A253 (m ²)	Preisgr. A253 (m ²)	Preisgr. A268 (m ²)		
	9023-2120H	<i>9023-2250H^{1/3}</i>	<i>9023-2270H^{1/3}</i>	<i>9023-2280H^{1/3}</i>	<i>9023-2240H^{1/3}</i>	<i>9023-2821H</i>	goldgelb <input type="checkbox"/> V3
	Preisgr. A187 (m ²)	Preisgr. A253 (m ²)	Preisgr. A253 (m ²)	Preisgr. A253 (m ²)	Preisgr. A268 (m ²)		
	9025-2120H	9025-2250H	9025-2270H	9025-2280H	9025-2240H	<i>9025-2821H</i>	amber <input type="checkbox"/> V2
	Preisgr. A187 (m ²)	Preisgr. A253 (m ²)	Preisgr. A253 (m ²)	Preisgr. A253 (m ²)	Preisgr. A268 (m ²)		
	9024-2120H	9024-2250H	9024-2270H	9024-2280H	9024-2240H	<i>9024-2821H</i>	blaugrün <input type="checkbox"/> V3
	Preisgr. A187 (m ²)	Preisgr. A253 (m ²)	Preisgr. A253 (m ²)	Preisgr. A253 (m ²)	Preisgr. A268 (m ²)		
	9030-2120H	9030-2250H	9030-2270H	9030-2280H	9030-2240H	<i>9030-2821H</i>	jadegrün <input type="checkbox"/> V1
	Preisgr. A187 (m ²)	Preisgr. A253 (m ²)	Preisgr. A253 (m ²)	Preisgr. A253 (m ²)	Preisgr. A268 (m ²)		
	9031-2120H	<i>9031-2250H^{1/3}</i>	<i>9031-2270H^{1/3}</i>	<i>9031-2280H^{1/3}</i>	<i>9031-2240H^{1/3}</i>	<i>9031-2821H</i>	beryllrot <input type="checkbox"/> V1
	Preisgr. A187 (m ²)	Preisgr. A253 (m ²)	Preisgr. A253 (m ²)	Preisgr. A253 (m ²)	Preisgr. A268 (m ²)		
	9032-2120H	<i>9032-2250H^{1/3}</i>	<i>9032-2270H^{1/3}</i>	<i>9032-2280H^{1/3}</i>	<i>9032-2240H^{1/3}</i>	<i>9032-2821H</i>	benitblau <input type="checkbox"/> V1
	Preisgr. A187 (m ²)	Preisgr. A253 (m ²)	Preisgr. A253 (m ²)	Preisgr. A253 (m ²)	Preisgr. A268 (m ²)		
	9033-2120H	<i>9033-2250H^{1/3}</i>	<i>9033-2270H^{1/3}</i>	<i>9033-2280H^{1/3}</i>	<i>9033-2240H^{1/3}</i>	<i>9033-2821H</i>	hämatitschwarz <input type="checkbox"/> V1
	Preisgr. A187 (m ²)	Preisgr. A253 (m ²)	Preisgr. A253 (m ²)	Preisgr. A253 (m ²)	Preisgr. A268 (m ²)		



² Lieferung als Doppelplatten; müssen örtlich gebrochen werden.

³ Mindestabnahmemenge: 250 m²

⁴ Das Format 2821 wird mit einer geklebten Kante ausgeführt. Preisstellung wird objektspezifisch kalkuliert.

⁵ Für Format 2270 gilt: Fertigungsbedingt fallen bei diesem Artikel rechte und linke überglasierte Kopfanten im Verhältnis 1 zu 1 an und müssen abgenommen werden. Es kann nur eine Längskante glasiert werden.

Für die Serie Craft gilt:

Mindestabnahmemenge bei Sonderfarben: 500 m²

Minderpreisenpreis auf Anfrage.

Eine Überproduktion von 10 % muss mit abgenommen werden.

Überglasierte Kante(n) bis max. 25 % der Auftragsmenge möglich.

Gesonderte Bestellung nötig.

Schenkelplatten 12,5 x 25 cm auf Anfrage geklebt machbar. Preisstellung wird objektspezifisch kalkuliert.



Wohnquartier Bellaria, Zürich-Wollishofen, Schweiz / Architekt: Michael Meier und Marius Hug Architekten AG, Zürich, Schweiz / Foto: Adriano Faragulo





Unifarben



kalkweiß

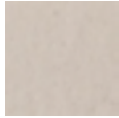

naturweiß



perlgrau

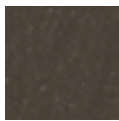

naturgrau



resedagrün



karmesinrot



kobaltblau



tiefschwarz

Geflammte Farben



schilfgrün geflammt



rotbraun geflammt



petrolblau geflammt



Langriemchen 6,2 x 50 cm, eben



Langriemchen Spitzprofil symmetrisch 6,2 x 50 cm, profiliert



Abdeckplatte Tropfkante, 31 x 30 cm, eben



6,2 x 50 cm

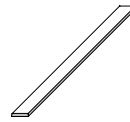

Riemchen

6,2 x 50 cm

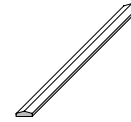

Spitzprofil sym.

31 x 30 cm¹



Abdeckplatte
Tropfkante



				2320	2290	9215	Formatnummer
				6,2 x 50 / 2 1/2 x 20	6,2 x 50 / 2 1/2 x 20	31 x 30 / 12 13/64 x 12	Nennmaß - cm/in
				52 x 490 x 11 mm	52 x 490 x 18/11 mm	300 x 300 x 15 mm	Herstellmaß
				eben, glänzend	profiliert, glänzend	eben, glänzend	Oberfläche
				32,258/m ²	32,258/m ²	3,226/m	m ² /m - Stück
				18,710/m ²	27,097 m ²	8,904/m	m ² /m - kg
				22	13	8	Paket - Stück
				0,682 m ²	0,403 m ²	2,480 m	Paket - m ² /m
				12,760	10,920	22,080	Paket - kg
				40,920	24,180		Palette - m ²
				765,600	655,200		Palette - kg
				Alla	Alla	Alla	Produktnorm
				19027-2320H	19027-2290H	19027-9215H	kalkweiß <input type="checkbox"/> V1
				Preisgr. A175 (m ²)	Preisgr. A274 (m ²)	Preisgr. A471 (St.)	
				19026-2320H	19026-2290H	19026-9215H	naturweiß <input type="checkbox"/> V1
				Preisgr. A175 (m ²)	Preisgr. A274 (m ²)	Preisgr. A471 (St.)	
				19022-2320H	19022-2290H	19022-9215H	perlgrau <input type="checkbox"/> V1
				Preisgr. A175 (m ²)	Preisgr. A274 (m ²)	Preisgr. A471 (St.)	
				19021-2320H	19021-2290H ^{1/2}	19021-9215H	naturgrau <input type="checkbox"/> V1
				Preisgr. A175 (m ²)	Preisgr. A274 (m ²)	Preisgr. A471 (St.)	
				19020-2320H	19020-2290H	19020-9215H	schilfgrün <input type="checkbox"/> V2
				Preisgr. A175 (m ²)	Preisgr. A274 (m ²)	Preisgr. A471 (St.)	
				19025-2320H	19025-2290H	19025-9215H	rotbraun <input type="checkbox"/> V3
				Preisgr. A175 (m ²)	Preisgr. A274 (m ²)	Preisgr. A471 (St.)	
				19024-2320H	19024-2290H	19024-9215H	petrolblau <input type="checkbox"/> V3
				Preisgr. A175 (m ²)	Preisgr. A274 (m ²)	Preisgr. A471 (St.)	
				19030-2320H	19030-2290H	19030-9215H	resedagrün <input type="checkbox"/> V1
				Preisgr. A175 (m ²)	Preisgr. A274 (m ²)	Preisgr. A471 (St.)	
				19031-2320H	19031-2290H ^{1/2}	19031-9215H	karmesinrot <input type="checkbox"/> V1
				Preisgr. A175 (m ²)	Preisgr. A274 (m ²)	Preisgr. A471 (St.)	
				19032-2320H	19032-2290H ^{1/2}	19032-9215H	kobaltblau <input type="checkbox"/> V1
				Preisgr. A175 (m ²)	Preisgr. A274 (m ²)	Preisgr. A471 (St.)	
				19033-2320H	19033-2290H ^{1/2}	19033-9215H	tiefschwarz <input type="checkbox"/> V1
				Preisgr. A175 (m ²)	Preisgr. A274 (m ²)	Preisgr. A471 (St.)	



² Mindestabnahmemenge: 250 m²



Für die Serie Craft Extended gilt:

Mindestabnahmemenge bei Sonderfarben: 500 m²

Minderpreisenpreise auf Anfrage.

Eine Überproduktion von 10 % muss mit abgenommen werden.

Überglasierte Kante(n) mit 25 % der Auftragsmenge möglich, gesonderte Bestellung nötig.





Urban und stylish

Facettenfliesen wie District liegen derzeit sehr im Trend. Ob in Küche, Bad, Läden oder Wohnbereichen – sie sorgen für edlen, minimalistischen oder stylischen Look, je nach Farbe und Anwendungsbereich. Mit District stehen acht Trendfarben zur Auswahl. Alle sind in den Formaten 5 x 10 cm und 10 x 25 cm erhältlich. Durch die rückseitige thermoplastische Verklebung beim Format 5 x 10 cm sind diese zudem besonders einfach als Matten zu verlegen.

Studioaufnahme / Architekten: VSBL, Belgrad, Serbien
Foto: Jochen Stüber



Wandfliese 5 x 10 cm, Facette almond beige, reliefiert



Wandfliese 5 x 10 cm, Facette white, reliefiert



Wandfliese 10 x 25 cm, Facette almond beige, reliefiert



Wandfliese 10 x 25 cm, Facette white, reliefiert

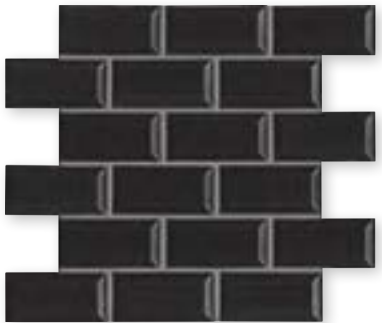

Wandfliese 5 x 10 cm, Facette pitch black, reliefiert



Wandfliese 5 x 10 cm, Facette ash grey, reliefiert



Wandfliese 10 x 25 cm, Facette pitch black, reliefiert



Wandfliese 10 x 25 cm, Facette ash grey, reliefiert



Wandfliese 5 x 10 cm, Facette miami mint, reliefiert

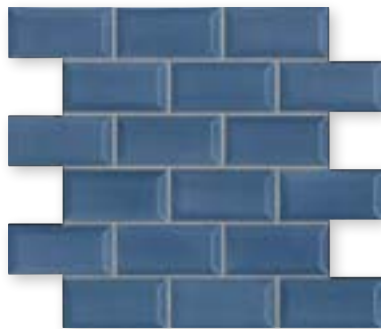

Wandfliese 5 x 10 cm, Facette denim blue, reliefiert



Wandfliese 10 x 25 cm, Facette miami mint, reliefiert



Wandfliese 10 x 25 cm, Facette denim blue, reliefiert



Wandfliese 5 x 10 cm, Facette racing green, reliefiert

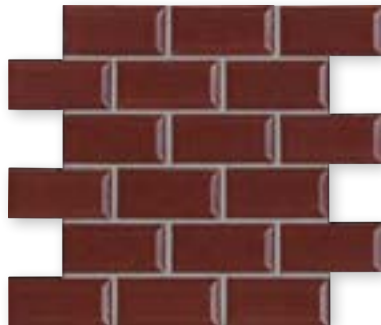

Wandfliese 5 x 10 cm, Facette burgundy red, reliefiert



Wandfliese 10 x 25 cm, Facette racing green, reliefiert



Wandfliese 10 x 25 cm, Facette burgundy red, reliefiert



Rückseitig thermoplastisch verklebte Mosaik von Agrob Buchtal sind nicht nur im Trockenbereich, sondern auch bedenkenlos im Unterwasserbereich (z. B. Schwimmbecken/Whirlpool) sowie im dauernassbelasteten Bereich einsetzbar.

Wandfliesen

5 x 10 cm¹



10 x 25 cm



Facette

Bogen: 316 x 316 mm

Facette



					5 x 10 / 2 x 4	10 x 25 / 4 x 10			Nennmaß - cm/in
					50 x 102 x 6,5 mm	97 x 247 x 6,5 mm			Herstellmaß
					reliefiert, glänzend	reliefiert, glänzend			Oberfläche
					10 Bögen	40,000			m ² - Stück
					16,570	19,000			m ² - kg
					8 Bögen	20			Paket - Stück
					0,800	0,500			Paket - m ²
					13,256	9,500			Paket - kg
					48,000	64,000			Palette - m ²
					795,360	1.216,000			Palette - kg
					Blb	Blb			Produktnorm
					45550H	45600H			almond beige <input type="checkbox"/>
					Preisgr. A169 (m ²)	Preisgr. A151 (m ²)			white <input type="checkbox"/>
					45551H	45601H			pitch black <input type="checkbox"/>
					Preisgr. A169 (m ²)	Preisgr. A151 (m ²)			ash grey <input type="checkbox"/>
					45552H	45602H			miami mint <input type="checkbox"/>
					Preisgr. A169 (m ²)	Preisgr. A151 (m ²)			denim blue <input type="checkbox"/>
					45553H	45603H			racing green <input type="checkbox"/>
					Preisgr. A169 (m ²)	Preisgr. A151 (m ²)			burgundy red <input type="checkbox"/>
					45554H	45604H			
					Preisgr. A169 (m ²)	Preisgr. A151 (m ²)			
					45555H	45605H			
					Preisgr. A169 (m ²)	Preisgr. A151 (m ²)			
					45556H	45606H			
					Preisgr. A169 (m ²)	Preisgr. A151 (m ²)			
					45557H	45607H			
					Preisgr. A169 (m ²)	Preisgr. A151 (m ²)			



Nur für die Verlegung an der Wand geeignet.





Leitfähige Bodenbeläge

Diese beiden speziellen Problemlösungen – einmal als Spaltplatte (Eladuct), einmal als keramische Großplatte im Format 60 x 60 cm (ELA 10.6) – eignen sich zur Anwendung in jenen Bereichen, die wegen elektrostatischer Aufladung einen leitfähigen Bodenbelag aufweisen müssen oder für die ein solcher empfohlen wird. Dabei sind besondere Verlegevorschriften zu beachten. Wir beraten Sie gerne detailliert und auf den Einzelfall abgestimmt.

Eladuct

Elektrostatisch ableitende unglasierte Spaltplatten



355S
Eladuct unglasiert

Schnitt

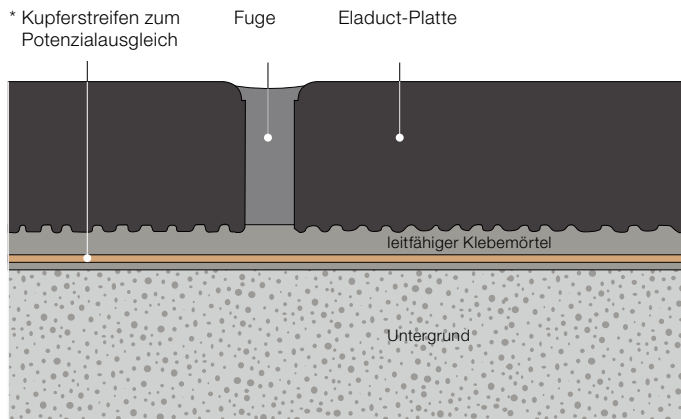

* Anzahl und Anordnung je nach technischen Erfordernissen. Der Anschluss ist durch eine Elektrofachkraft gemäß den entsprechenden Richtlinien vorzunehmen.

Bei Eladuct erfolgt die Ableitung durch den Plattenkörper. Durchgangswiderstand nach Verfahren A gemäß DIN EN 1081: 10^8 Ohm.



Leitfähige Bodenbeläge

Diese beiden speziellen Problemlösungen – einmal als Spaltplatte (Eladuct), einmal als keramische Großplatte im Format 60 x 60 cm (ELA 10.6) – eignen sich zur Anwendung in jenen Bereichen, die wegen elektrostatischer Aufladung einen leitfähigen Bodenbelag aufweisen müssen oder für die ein solcher empfohlen wird. Dabei sind besondere Verlegevorschriften zu beachten. Wir beraten Sie gerne detailliert und auf den Einzelfall abgestimmt.

Eladuct

ist insbesondere prädestiniert für Bereiche, wo elektrostatische Ableitfähigkeit und die Vorteile einer unglasierten Oberfläche (hohe mechanisch-chemische Belastbarkeit) erwünscht sind.

Beispiele: Tief- und Flexodruckbereiche, Laboratorien, Räume für Lackherstellung, -verarbeitung und Umfüllung, Munitionsdepots, chemische Produktionsbetriebe etc.

KerAion ELA 10.6

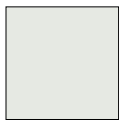

2401 RH · IV
grau glasiert

(RH = rutschhemmende Version)

Schnitt

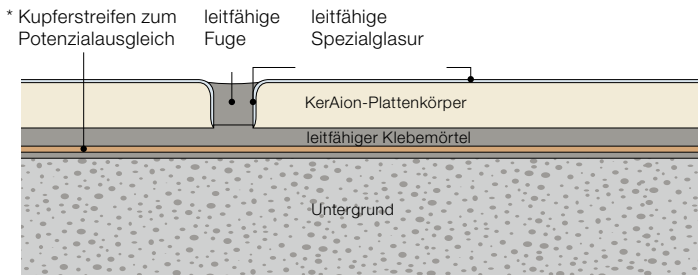

* Anzahl und Anordnung je nach technischen Erfordernissen. Der Anschluss ist durch eine Elektrofachkraft gemäß den entsprechenden Richtlinien vorzunehmen.

Bei ELA 10.6 erfolgt die Ableitung über die vier überglasierten Plattenkanten. Oberflächenwiderstand nach Verfahren C gemäß DIN EN 1081: 10^6 Ohm. Ableitwiderstand R_A gemäß DIN EN 1081: 10^6 Ohm.



KerAion ELA 10.6

empfeht sich für jene Bereiche, wo elektrostatische Ableitfähigkeit erwünscht ist und Wert gelegt wird auf die Vorteile einer glasierten Oberfläche (z. B. besonders reinigungsfreundlich) und eine großzügige, repräsentative Optik. Beispiele: Büroräume, Produktionsräume für elektronische Geräte, physikalische Mess- und Arbeitsräume, Labors, Räume für Microchip- und Computerfertigung, medizinische Bereiche (z. B. OP-Räume), Fernmeldewerkstätten, Elektronik-Verkaufsräume etc.

Bodenplatten Sockelsystem

25 x 12,5 cm



25 x 8,9 cm



			Hohlkehlsockel r = 9 mm	Außenecke Gehrungspaar	Innenecke Gehrungspaar	
		1110	4000	4003	4004	Formatnummer
		25 x 12,5 / 10 x 5	25 x 8,9 / 10 x 3 1/2			Nennmaß - cm/in
		240 x 115 x 20	240 x 79/9 x 11	(2x) 131 x 79/9 x 11	(2x) 115 x 79/9 x 11	Herstellmaß - mm
		eben, matt	eben, matt	eben, matt	eben, matt	Oberfläche
		33,000/m ²	4,000/m			m ² /m - Stück
		53,955/m ²	2,200/m	0,590/Paar	0,550/Paar	m ² /m/Paar - kg
		13 Stück	16 Stück	8 Paar	8 Paar	Paket - St./Paar
		0,394 m ²	4,000 m			Paket - m ² /m
		21,255	8,800	4,720	4,400	Paket - kg
		23,636				Palette - m ²
		1.275,300				Palette - kg
		Alb	Alb	Alb	Alb	Produktnorm
		R10				Trittsicherheit
		4				Belastung
		355S-1110	355S-4000	355S-4003¹	355S-4004¹	355S Eladuct
		Preisgr. A346 (m ²)	Preisgr. A467 (St.)	Preisgr. A528 (Paar)	Preisgr. A528 (Paar)	unglasiert

Bei Eladuct erfolgt die Ableitung durch den Plattenkörper.
Durchgangswiderstand nach Verfahren A gemäß DIN EN 1081: 10⁸ Ohm.
Die 355s definiert sich über den Durchgangswiderstand und nicht über die Farbstellung.
Farbabweichungen müssen akzeptiert werden und sind kein Beanstandungsgrund.



KerAion ELA 10.6

Bodenplatten Sockelsystem (elektrostatisch ableitend) (nicht elektrostatisch ableitend)

60 x 60 cm

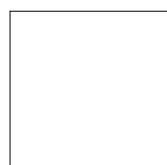

30 x 8,7 cm



			Hohlkehlsockel r = 12 mm	Außenecke links	Außenecke rechts	Innenecke Gehrungspaar	
		K100	37040	37043	37044	37042	Formatnummer
		60 x 60 / 24 x 24	30 x 8,7 / 12 x 3 1/2				Nennmaß - cm/in
		592 x 592 x 8	292 x 79/12 x 8	280/292 x 79/12 x 8	280/292 x 79/12 x 8	(2x) 292 x 79/12 x 8	Herstellmaß - mm
		eben, matt	eben, matt	eben, matt	eben, matt	eben, matt	Oberfläche
		2,860/m ²	3,333/m				m ² /m - Stück
		18,533/m ²	1,700/m	0,550/Stück	0,550/Stück	1,100/Paar	m ² /m/St./Paar - kg
		4 Stück	32 Stück	32 Stück	32 Stück	16 Paar	Paket - St./Paar
		1,399 m ²	9,601 m				Paket - m ² /m
		25,920	16,320	17,600	17,600	17,600	Paket - kg
		41,958					Palette - m ²
		777,600					Palette - kg
		Alb	Alb	Alb	Alb	Alb	Produktnorm
		R9					Trittsicherheit
		2					Belastung
		2401RH-K100-21	590-37040-21	590-37043-21	590-37044-21	590-37042-21	4
		Preisgr. A346 (m ²)	Preisgr. A445 (St.)	Preisgr. A458 (St.)	Preisgr. A458 (St.)	Preisgr. A489 (Paar)	grau glasiert
							grau glasiert

Bei KerAion ELA 10.6 erfolgt die Ableitung über die vier überglasierten Plattenkanten.
Oberflächenwiderstand nach Verfahren C gemäß DIN EN 1081: 10⁶ Ohm.







Modular und zeitlos

Mit aufeinander abgestimmten Farben und Oberflächen, rutschhemmenden Fliesen von R9 bis R12V4 und Formaten von 30 x 30 bis 60 x 60 cm bieten die Fliesen der Serie Emotion Architekten viel Freiraum. Emotion sorgt vor allem dort für eine gute Gestaltung, wo es um den Übergang zwischen Bereichen mit unterschiedlichen Anforderungen an die Rutschhemmung geht. Front cooking im Blickkontakt zu den Restaurantgästen wird dadurch ebenso möglich wie das reibungslose und ästhetisch gelungene Nebeneinander von Werkstatt und Showroom in einem Autohaus.

Studioaufnahme / Architektin: Sylvia Leydecker / Foto: Jochen Stüber



R9 R10/A R11/B



Oberflächen: Bodenfliesen



R9

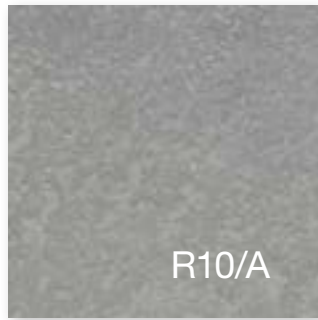

R10/A

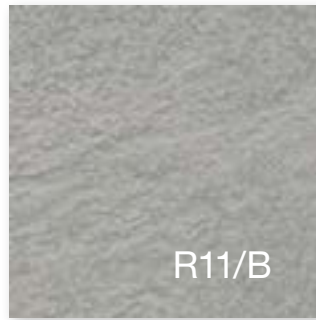

R11/B



basalt



hellbeige



tiefanthrazit



mittelgrau



Bodenfliese 30 x 30 cm
strukturiert, R10/A



Bodenfliese 30 x 30 cm
reliefiert, R11/B



Bodenfliese 30 x 60 cm, eben, R9
Bodenfliese 30 x 60 cm, strukturiert, R10/A
Bodenfliese 30 x 60 cm, reliefiert, R11/B



Bodenfliese 60 x 60 cm, eben, R9
Bodenfliese 60 x 60 cm, strukturiert, R10/A



Treppenfliese 30 x 60 cm (rilliert), eben, R9
Treppenfliese 30 x 60 cm (rilliert), strukturiert, R10/A



Sockel, gerundet 7 x 60 cm, eben
Sockel, gerundet 7 x 60 cm, strukturiert

Keramische Rinnenabdeckung
Ecklösung 30 x 30 cm

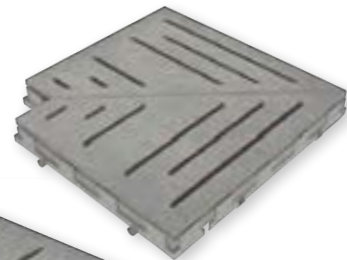

Keramische Rinnenabdeckung
25 x 50 cm



Details zur Keramischen Rinnenabdeckung siehe Lieferprogramm Pool + Spa.

Bodenfliesen¹

30 x 30 cm



30 x 30 cm



30 x 60 cm

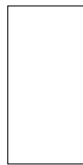

30 x 60 cm



30 x 60 cm



60 x 60 cm



60 x 60 cm

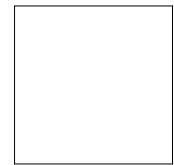

protected

Nennmaß - cm/in	30 x 30 / 12 x 12	30 x 30 / 12 x 12	30 x 60 / 12 x 24	30 x 60 / 12 x 24	30 x 60 / 12 x 24	60 x 60 / 24 x 24	60 x 60 / 24 x 24
Herstellmaß	297 x 297 x 10,5 mm	297 x 297 x 10,5 mm	297 x 597 x 10,5 mm	297 x 597 x 10,5 mm	297 x 597 x 10,5 mm	597 x 597 x 10,5 mm	597 x 597 x 10,5 mm
Oberfläche	strukturiert, matt	reliefiert, matt	eben, matt	strukturiert, matt	reliefiert, matt	eben, matt	strukturiert, matt
m ² - Stück	11,110	11,110	5,556	5,556	5,556	2,778	2,778
m ² - kg	23,142	23,142	23,224	23,224	23,224	23,769	23,769
Paket - Stück	11	11	6	6	6	3	3
Paket - m ²	0,990	0,990	1,080	1,080	1,080	1,080	1,080
Paket - kg	22,913	22,913	25,080	25,080	25,080	25,668	25,668
Palette - m ²	47,525	47,525	43,197	43,197	43,197	38,877	38,877
Palette - kg	1.099,824	1.099,824	1.003,200	1.003,200	1.003,200	924,048	924,048
Produktnorm	Bla	Bla	Bla	Bla	Bla	Bla	Bla
Trittsicherheit	R10/A	R11/B	R9	R10/A	R11/B	R9	R10/A
Belastung	3	3	2	2	2	3	3
tiefanthrazit	433730 Preisgr. A70 (m ²)	433733 Preisgr. A70 (m ²)	433402 Preisgr. A97 (m ²)	433406 Preisgr. A109 (m ²)	433410 Preisgr. A109 (m ²)	433660 Preisgr. A124 (m ²)	433664 Preisgr. A124 (m ²)
hellbeige	433732 Preisgr. A70 (m ²)	433735 Preisgr. A70 (m ²)	433404 Preisgr. A97 (m ²)	433408 Preisgr. A109 (m ²)	433412 Preisgr. A109 (m ²)	433662 Preisgr. A124 (m ²)	433666 Preisgr. A124 (m ²)
mittelgrau	433731 Preisgr. A70 (m ²)	433734 Preisgr. A70 (m ²)	433403 Preisgr. A97 (m ²)	433407 Preisgr. A109 (m ²)	433411 Preisgr. A109 (m ²)	433661 Preisgr. A124 (m ²)	433665 Preisgr. A124 (m ²)
basalt	433440 Preisgr. A70 (m ²)	433442 Preisgr. A70 (m ²)	433430 Preisgr. A97 (m ²)	433432 Preisgr. A109 (m ²)	433434 Preisgr. A109 (m ²)	433436 Preisgr. A124 (m ²)	433438 Preisgr. A124 (m ²)



Treppenfliesen^{1/2}

30 x 60 cm

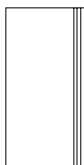

30 x 60 cm

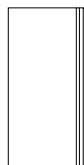

7 x 60 cm



7 x 60 cm



15 x 60 cm



15 x 15 cm



protected

Nennmaß - cm/in	30 x 60 / 12 x 24	30 x 60 / 12 x 24	7 x 60 / 2 13/16 x 24	7 x 60 / 2 13/16 x 24	15 x 60 / 6 x 24	15 x 15 / 6 x 6
Herstellmaß	297 x 597 x 10,5 mm	297 x 597 x 10,5 mm	70 x 597 x 10,5 mm	70 x 597 x 10,5 mm	158 x 597 x 10,5 mm	158 x 158 x 10,5 mm
Oberfläche	eben, matt	strukturiert, matt	eben, matt	strukturiert, matt	strukturiert, matt	strukturiert, matt
m - Stück	1,667	1,667	1,667	1,667	1,667	
m - kg	6,968	6,968	1,717	1,717	4,334	
Paket - Stück	6	6	22	22	4	4
Paket - m	3,599	3,599	13,197	13,197	2,399	
Paket - kg	25,080	25,080	22,660	22,660	10,400	6,000
Palette - m						
Palette - kg						
Produktnorm	Bla	Bla	Bla	Bla	Bla	Bla
Trittsicherheit	R9	R10/A			R10/A	R10/A
Belastung	2	2				
tiefanthrazit	433850 Preisgr. A475 (St.)	433854 Preisgr. A475 (St.)	433802 Preisgr. A434 (m ²)	433806 Preisgr. A434 (m ²)		
hellbeige	433852 Preisgr. A475 (St.)	433856 Preisgr. A475 (St.)	433804 Preisgr. A434 (m ²)	433808 Preisgr. A434 (m ²)	432805-HKS Preisgr. A573 (St.)	432805-IE Preisgr. A601 (St.)
mittelgrau	433851 Preisgr. A475 (St.)	433855 Preisgr. A475 (St.)	433803 Preisgr. A434 (m ²)	433807 Preisgr. A434 (m ²)		
basalt	433817 Preisgr. A475 (St.)	433819 Preisgr. A475 (St.)	433821 Preisgr. A434 (m ²)	433823 Preisgr. A434 (m ²)		



³ Mindestmenge 50 Stück

⁴ Auf Anfrage auch in anderen Farben erhältlich

⁵ Detailzeichnungen Hohlkehlssockel und Innenecke siehe S. 536

Weitere Hohlkehlssockel finden Sie auf S. 201 unter der Serie Emotion Grip. Achtung: Farbabweichung zum Sortiment Emotion, da Feinkornoptik









R10/A R11/B R11V4 R12 R12V4 R12V8 R13 R13V10



Oberflächen: Bodenfliesen

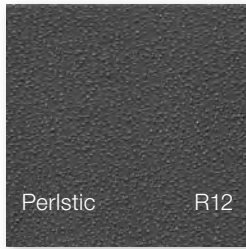
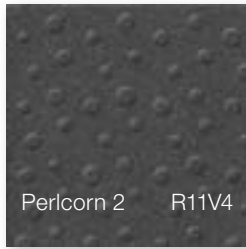
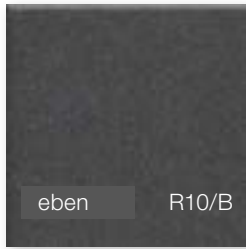

Mosaik 10 x 10 cm

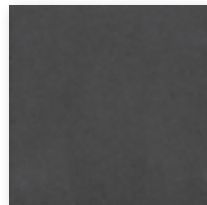
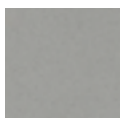
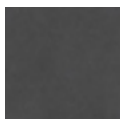
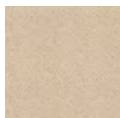

Bodenfliese 20 x 20 cm, eben, R10/A
 Bodenfliese 20 x 20 cm, Softcorn 2, R11/B
 Bodenfliese 20 x 20 cm, Perlcorn 2, R11V4
 Bodenfliese 20 x 20 cm, Perlstic, R12
 Bodenfliese 20 x 20 cm, Carostic, R12V4
 Bodenfliese 20 x 20 cm, Picstic, R12V8, überstark
 Bodenfliese 20 x 20 cm, Geraut, R13, überstark
 Bodenfliese 20 x 20 cm, Kombicorn, R13V10, überstark

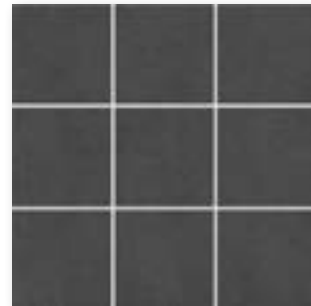

Mosaikbogen 30 x 30 cm, eben, R10/B

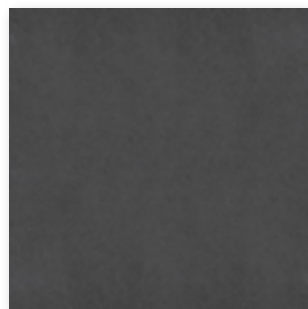

Bodenfliese 30 x 30 cm, eben, R10/A

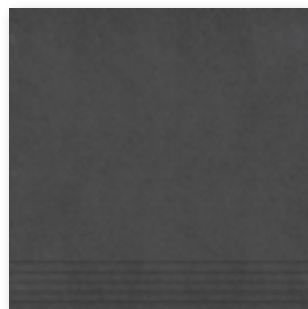

Treppenfliese 30 x 30 cm (rilliert), eben, R10/A



Rückseitig thermoplastisch verklebte Mosaik von Agrob Buchtal sind nicht nur im Trockenbereich, sondern auch bedenkenlos im Unterwasserbereich (z. B. Schwimmbecken/ Whirlpool) sowie im dauernassbelasteten Bereich (z. B. Beckenumgänge/Duschen) einsetzbar.

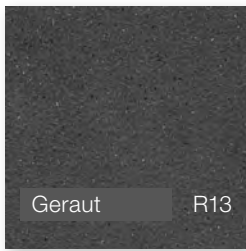
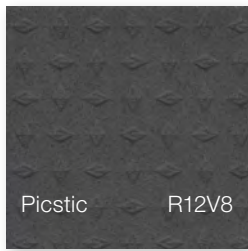

Sockel mit Fase 10 x 20 cm, eben



Hohlkehlssockel 10 x 20 cm
eben, R10/A



Hohlkehlssockel 10 x 30 cm
eben, R10/A



Innenecke
zu Hohlkehlssockel, eben



Außenecke
zu Hohlkehlssockel, eben



gelb



schwarz



Sicherheitsdreiecke, überstark 27,8 x 20 cm, gekörnt, R11



Verlegemuster

Mosaik¹

Wand-/Bodenfliesen

10 x 10 cm

20 x 20 cm

20 x 20 cm

20 x 20 cm

20 x 20 cm

20 x 20 cm



protected

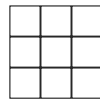

Bogen: 297 x 297 mm

Eben

Softcorn 2

Perlcorn 2

Perlstic

Carostic

Nennmaß - cm/in	10 x 10 / 4 x 4	20 x 20 / 8 x 8	20 x 20 / 8 x 8	20 x 20 / 8 x 8	20 x 20 / 8 x 8	20 x 20 / 8 x 8	20 x 20 / 8 x 8
Herstellmaß	97 x 97 x 6,5 mm	197 x 197 x 10,5 mm	197 x 197 x 10,5 mm	197 x 197 x 10,5 mm	197 x 197 x 10,5 mm	197 x 197 x 10,5 mm	197 x 197 x 10,5 mm
Oberfläche	eben, matt	eben, matt	strukturiert, matt	gekörnt, matt	gekörnt, matt	gekörnt, matt	profiliert, matt
m ² - Stück	11 Bögen	25,000	25,000	25,000	25,000	25,000	25,000
m ² - kg	13,101	22,900	22,900	22,900	22,900	22,900	22,900
Paket - Stück	11 Bögen	21	21	21	21	21	21
Paket - m ²	1,000	0,840	0,840	0,840	0,840	0,840	0,840
Paket - kg	13,101	19,236	19,236	19,236	19,236	19,236	19,236
Palette - m ²	64,000	50,400	50,400	50,400	50,400	50,400	50,400
Palette - kg	838,464	1.154,160	1.154,160	1.154,160	1.154,160	1.154,160	1.154,160
Produktnorm	Bla	Bla	Bla	Bla	Bla	Bla	Bla
Trittsicherheit	R10/B	R10/A	R11/B	R11V4	R12	R12	R12V4
Belastung	1	3	3	3	3	3	3
tiefanthrazit <input type="checkbox"/>	435026 Preisgr. A148 (m ²)	434216 Preisgr. A121 (m ²)	434219 Preisgr. A121 (m ²)	434222 Preisgr. A154 (m ²)	434225 Preisgr. A154 (m ²)	434228 Preisgr. A154 (m ²)	
mittelgrau <input type="checkbox"/>	435027 Preisgr. A148 (m ²)	434217 Preisgr. A121 (m ²)	434220 Preisgr. A121 (m ²)	434223 Preisgr. A154 (m ²)	434226 Preisgr. A154 (m ²)	434229 Preisgr. A154 (m ²)	
hellbeige <input type="checkbox"/>	435028 Preisgr. A148 (m ²)	434218 Preisgr. A121 (m ²)	434221 Preisgr. A121 (m ²)	434224 Preisgr. A154 (m ²)	434227 Preisgr. A154 (m ²)	434230 Preisgr. A154 (m ²)	
basalt <input type="checkbox"/>	435029 Preisgr. A148 (m ²)	434326 Preisgr. A121 (m ²)	434328 Preisgr. A121 (m ²)	434330 Preisgr. A154 (m ²)	434332 Preisgr. A154 (m ²)	434334 Preisgr. A154 (m ²)	



Wand-/
Bodenfliesen

Bodenfliesen²

30 x 30 cm

20 x 20 cm

20 x 20 cm

20 x 20 cm

20 x 20 cm

20 x 20 cm

20 x 20 cm



protected



eben

eben, überstark

Softcorn 2, überstark

Perlstic, überstark

Carostic, überstark

Picstic, überstark

Geraut, überstark

Nennmaß - cm/in	30 x 30 / 12 x 12	20 x 20 / 8 x 8	20 x 20 / 8 x 8	20 x 20 / 8 x 8	20 x 20 / 8 x 8	20 x 20 / 8 x 8	20 x 20 / 8 x 8
Herstellmaß	297 x 297 x 10,5 mm	197 x 197 x 15 mm	197 x 197 x 15 mm	197 x 197 x 15 mm	197 x 197 x 15 mm	197 x 197 x 15 mm	197 x 197 x 15 mm
Oberfläche	eben, matt	eben, matt	strukturiert, matt	gekörnt, matt	gekörnt, matt	eben, matt	profiliert, matt
m ² /m - Stück	11,111/m ²	25,767/m ²	25,767/m ²	25,767/m ²	25,767/m ²	25,767/m ²	25,767/m ²
m ² /m - kg	23,144/m ²	34,322/m ²	34,322/m ²	34,322/m ²	34,322/m ²	34,322/m ²	34,322/m ²
Paket - Stück	11	15	15	15	15	15	15
Paket - m ² /m	0,990 m ²	0,582 m ²	0,582 m ²	0,582 m ²	0,582 m ²	0,582 m ²	0,582 m ²
Paket - kg	22,913	19,980	19,980	19,980	19,980	19,980	19,980
Palette - m ²	47,520	34,928	34,928	34,928	34,928	34,928	34,928
Palette - kg	1.099,824	1.198,800	1.198,800	1.198,800	1.198,800	1.198,800	1.198,800
Produktnorm	Bla	Bla	Bla	Bla	Bla	Bla	Bla
Trittsicherheit	R10/A	R10/A	R11/B	R12	R12V4	R12V8	R13
Belastung	3	4	4	4	4	4	4
tiefanthrazit <input type="checkbox"/>	434239 Preisgr. A100 (m ²)	434231 Preisgr. A154 (m ²)	434233 Preisgr. A154 (m ²)	434235 Preisgr. A166 (m ²)	434237 Preisgr. A166 (m ²)	434976 Preisgr. A181 (m ²)	434978 Preisgr. A181 (m ²)
mittelgrau <input type="checkbox"/>	434240 Preisgr. A100 (m ²)	434232 Preisgr. A154 (m ²)	434234 Preisgr. A154 (m ²)	434236 Preisgr. A166 (m ²)	434238 Preisgr. A166 (m ²)	434977 Preisgr. A181 (m ²)	434979 Preisgr. A181 (m ²)
hellbeige <input type="checkbox"/>	434241 Preisgr. A100 (m ²)						
basalt <input type="checkbox"/>	434336 Preisgr. A100 (m ²)						



² Lieferzeit auf Anfrage

Sockel mit
Fase

Treppenfliesen

20 x 20 cm³

27,8 x 20 cm²

10 x 20 cm

30 x 30 cm¹



Kombicorn,
überstark

Sicherheitsdreiecke,
überstark



protected

			20 x 20 / 8 x 8	27,8 x 20 / 11 x 8	10 x 20 / 4 x 8	30 x 30 / 12 x 12	Nennmaß - cm/in
			197 x 197 x 15 mm	278 x 197/197 x 15 mm	97 x 197 x 10,5 mm	297 x 297 x 10,5 mm	Herstellmaß
			profiliert, matt	gekörnt, matt	eben, matt	eben, matt	Oberfläche
			25,767/m ²	3,597/1,798/m	5,000/m	3,333/m	m ² / m - Stück
			34,322/m ²	2,374/1,187/m	2,250/m	6,943/m	m ² / m/St. - kg
			15	28	20	10	Paket - Stück
			0,582 m ²	7,784/15,573 m	4,000 m	3,003 m	Paket - m/m ²
			19,980	18,480	9,000	20,830	Paket - kg
			34,928				Palette - m ²
			1.198,800				Palette - kg
			Bla	Bla	Bla	Bla	Produktnorm
			R13V10	R11			Trittsicherheit
			4	4		3	Belastung
			434980		434248	434251	tiefanthrazit <input type="checkbox"/>
			Preisgr. A181 (m ²)		Preisgr. A416 (St.)	Preisgr. A449 (St.)	
			434981		434249	434252	mittelgrau <input type="checkbox"/>
			Preisgr. A181 (m ²)		Preisgr. A416 (St.)	Preisgr. A449 (St.)	
					434250	434253	hellbeige <input type="checkbox"/>
					Preisgr. A416 (St.)	Preisgr. A449 (St.)	
					434342	434344	basalt <input type="checkbox"/>
					Preisgr. A416 (St.)	Preisgr. A449 (St.)	
				431321			gelb <input type="checkbox"/>
				Preisgr. A416 (St.)			
				431320			schwarz <input type="checkbox"/>
				Preisgr. A416 (St.)			



Hohlkehls sockel^{4/6}

Innenecke
zu Hohlkehls-
sockel^{4/5}

Außenecke
zu Hohlkehls-
sockel^{4/5}

10 x 20 cm

10 x 30 cm



protected

			10 x 20 / 4 x 8	10 x 30 / 4 x 12	102 x 20 x 9 mm	102 x 35 x 9 mm	Nennmaß - cm/in
			102 x 197 x 9 mm	102 x 297 x 9 mm	102 x 20 x 9 mm	102 x 35 x 9 mm	Herstellmaß
			eben, matt	eben, matt	eben, matt	eben, matt	Oberfläche
			5,000	3,333			m - Stück
			2,000/m	2,000/m	0,080/Stück	0,080/Stück	m/St. - kg
			20	16	18	12	Paket - Stück
			4,000	4,801			Paket - m
			8,000	9,600			Paket - kg
							Palette - m
							Palette - kg
			Bla	Bla	Bla	Bla	Produktnorm
			R10/A	R10/A			Trittsicherheit
			432027	432033	432039	432045	tiefanthrazit <input type="checkbox"/>
			Preisgr. A419 (St.)	Preisgr. A425 (St.)	Preisgr. A418 (St.)	Preisgr. A418 (St.)	
			432028	432034	432040	432046	mittelgrau <input type="checkbox"/>
			Preisgr. A419 (St.)	Preisgr. A425 (St.)	Preisgr. A418 (St.)	Preisgr. A418 (St.)	
			432029	432035	432041	432047	hellbeige <input type="checkbox"/>
			Preisgr. A419 (St.)	Preisgr. A425 (St.)	Preisgr. A418 (St.)	Preisgr. A418 (St.)	
			432030	432036	432042	432048	basalt <input type="checkbox"/>
			Preisgr. A419 (St.)	Preisgr. A425 (St.)	Preisgr. A418 (St.)	Preisgr. A418 (St.)	



² Angabe der logistischen Daten für einreihige bzw. doppelreihige Verlegung

³ Lieferzeit auf Anfrage

⁴ Details siehe S. 536

⁵ passend zu Hohlkehls sockel 10 x 20 / 10 x 30 cm

⁶ Produktionsbedingte Farbabweichungen zum angrenzenden Belag bei liegender Verlegung sind nicht reklamationstauglich





Luxuriös und harmonisch

Ob in Kombination mit Naturmaterialien, Pastellfarben oder Metall: Evalia passt sich individuellen Wohnideen an und bringt eine geschmackvolle, luxuriöse Note ein. Zu den großformatigen Bodenfliesen in Grau, Beige und Anthrazit harmonieren die Wandfliesen in Graubeige matt oder glänzend. Ebenfalls in Graubeige: das Dekor Shino im Format 30 x 60 cm und das R10/B-Mosaik im Format 5 x 5 cm, die im gleichen Look & Feel der Serie für Dynamik in der Gestaltung sorgen. Wandfliesen, Dekor und Mosaik sind durch die Hytect-Oberfläche reinigungsfreundlich. Sockel runden das Fliesenprogramm ab.

Rendering



Wandfliese 30 x 60 cm, graubeige, eben



Wandfliese 30 x 90 cm, graubeige, eben

Dekorationselemente



Dekorfliese Shino 30 x 60 cm, graubeige, eben

Dekorationselemente



Dekorfliese Shino 30 x 90 cm, graubeige, eben

Farbunterschiede sind möglich und Bestandteil des Designs. Bei der von Ihnen ausgewählten Dekoration handelt es sich um ein hochwertiges Produkt aus Steingut glasiert, das mit einer besonders realistischen Steinoptik überzeugt. Die Dekoration besteht aus unterschiedlichen Einzelbildern. Die Anschlüsse der Einzelbilder sind bewusst frei gestaltet, und verbinden sich somit nicht in der fortlaufenden Verlegung.



grau



beige



anthrazit



Bodenfliese 60 x 60 cm, eben, R9



Sockel, gerundet 7 x 60 cm, eben

Mosaik 5 x 5 cm



Mosaikbogen Shino 30 x 30 cm
graubeige, eben, R10/B



Rückseitig thermoplastisch verklebte Mosaik von Agrob Buchtal sind nicht nur im Trockenbereich, sondern auch bedenkenlos im Unterwasserbereich (z. B. Schwimmbecken/Whirlpool) sowie im dauernassbelasteten Bereich (z. B. Beckenumgänge/Duschen) einsetzbar.

Wandfliesen

30 x 60 cm¹



30 x 60 cm¹



30 x 90 cm²

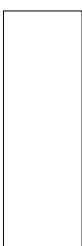

30 x 90 cm²



Dekorationselemente^{4/5}

30 x 60 cm¹



30 x 90 cm²



	30 x 60 / 12 x 24	30 x 60 / 12 x 24	30 x 90 / 12 x 36	30 x 90 / 12 x 36	Shino 30 x 60 / 12 x 24	Shino 30 x 90 / 12 x 36	
	297 x 597 x 9 mm	297 x 597 x 9 mm	297 x 897 x 10,5 mm	297 x 897 x 10,5 mm	297 x 597 x 9 mm	297 x 897 x 10,5 mm	Nennmaß - cm/in
	eben, glänzend	eben, seidenmatt	eben, glänzend	eben, seidenmatt	eben, glänzend	eben, glänzend	Herstellmaß
	5,556	5,556	3,704	3,704	5,556	3,704	Oberfläche
	15,279	15,279	17,976	17,976	15,279	17,976	m ² - Stück
	9	9	5	5	9	5	m ² - kg
	1,620	1,620	1,350	1,350	1,620	1,350	Paket - Stück
	24,750	24,750	24,265	24,265	24,750	24,265	Paket - m ²
	77,754	77,754	32,397	32,397	77,754	32,397	Paket - kg
	1.188,000	1.188,000	582,360	582,360	1.188,000	582,360	Palette - m ²
	BIII	BIII	BIII	BIII	BIII	BIII	Palette - kg
	283102HR	283126HR	393104H	393127H			Produktnorm
	Preisgr. C122 (m ²)	Preisgr. C122 (m ²)	Preisgr. C149 (m ²)	Preisgr. C149 (m ²)			graubeige V2
					283103HR	393105H	graubeige V4
					Preisgr. C128 (m ²)	Preisgr. C155 (m ²)	

Mosaik^{3/6}

5 x 5 cm



Bodenfliesen¹ Sockel, gerundet¹

60 x 60 cm

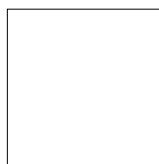

7 x 60 cm



protected

				Shino Bogen: 297 x 297 mm	Shino 5 x 5 / 2 x 2	Shino 60 x 60 / 24 x 24	Shino 7 x 60 / 2 13/16 x 24	
					47 x 47 x 6,5 mm	595 x 595 x 9,5 mm	70 x 595 x 9,5 mm	Nennmaß - cm/in
					eben, matt	eben, lappato	eben, lappato	Herstellmaß
					11 Bögen	2,778/m ²	1,667/m	Oberfläche
					12,331/m ²	21,112/m ²	1,470/m	m ² /m - Stück
					11 Bögen	4	15	m ² /m - kg
					1,000 m ²	1,440 m ²	8,998 m	Paket - Stück
					12,331	30,400	13,230	Paket - m ² /m
					64,000	46,076		Paket - kg
					789,184	972,800		Palette - m ²
					Bla	Bla	Bla	Palette - kg
					R10/B	R9		Produktnorm
					1	2		Trittsicherheit
					431919H			Belastung
					Preisgr. C230 (m ²)			graubeige V4
						431913	431920	grau V3
						Preisgr. C155 (m ²)	Preisgr. C440 (St.)	
						431914	431921	beige V3
						Preisgr. C155 (m ²)	Preisgr. C440 (St.)	
						431915	431922	anthrazit V3
						Preisgr. C155 (m ²)	Preisgr. C440 (St.)	

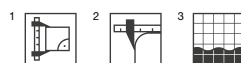

⁴ Die Dekoration besteht aus unterschiedlichen Einzelbildern. Die Anschlüsse der Einzelbilder sind bewusst frei gestaltet und verbinden sich somit nicht in der fortlaufenden Verlegung. Die Motivzusammenstellung im Karton kann produktionsbedingt variieren.

⁵ Abgabe der Dekorationselemente ausschließlich in vollen Kartons.

⁶ ohne Protecta-Vergütung; mit Hytect-Veredelung





Authentische Oberfläche

Die Serie Factory überträgt gelebte Betonböden keramisch, der so entstandene Belag wirkt lebendig und unkompliziert. In Kombination mit klassischen Ornamentakzenten entsteht eine Serie, die die Stilwelten Industrial & Modern Country wohnlich verbindet. Farbtöne aus beiden Welten runden das Konzept ab und bedienen individuelle Gestaltungsvorlieben. Factory enthält mit Circle auch ein vielseitiges Dekorelement für Wand und Boden, das Akzente setzt, ohne modisch oder dominant zu erscheinen. Alle Produkte sind Hytect-veredelt und deshalb besonders pflegeleicht.

Rendering



Wandfliese 30 x 60 cm, cotton, strukturiert

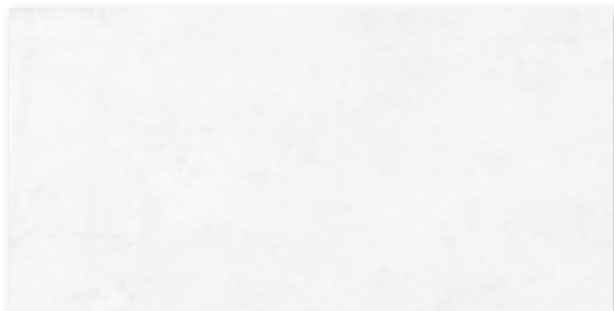

Wandfliese 30 x 60 cm, smoke white, strukturiert



Wandfliese 30 x 90 cm, cotton, strukturiert

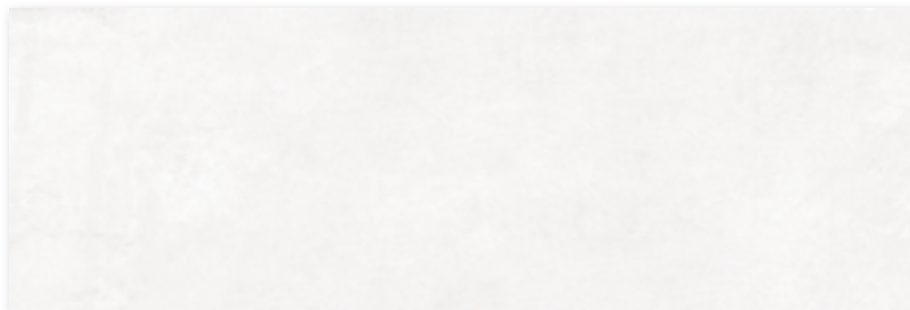

Wandfliese 30 x 90 cm, smoke white, strukturiert

Dekorationselemente



Dekorfliese Circle 30 x 60 cm, cotton, strukturiert



Dekorfliese Circle 30 x 60 cm, smoke white, strukturiert



Dekorfliese Circle 30 x 90 cm, cotton, strukturiert



Dekorfliese Circle 30 x 90 cm, smoke white, strukturiert



lime



bronze grey



aluminium

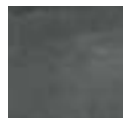

asphalt

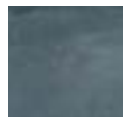

blue steel



Bodenfliese 30 x 60 cm, strukturiert, R10/A+B



Bodenfliese 60 x 60 cm, strukturiert, R10/A+B



Bodenfliese 60 x 120 cm, strukturiert, R10/A+B

Mosaik 5 x 5 cm



Mosaikbogen 30 x 30 cm, strukturiert, R10/A+B

Mosaik: Verklebung rückseitig auf Glasfasernetz,
Bogen: 297 x 297 mm

Dekorationselemente



Bodendekor Circle 60 x 60 cm, strukturiert, R10/A+B



Terrassenplatte 60 x 60 cm, strukturiert, R11/B

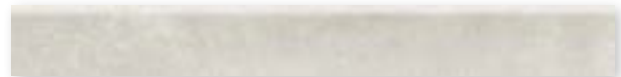

Sockel, gerundet 7 x 60 cm, strukturiert



Treppenfiese 30 x 120 cm (rilliert), strukturiert, R10/A+B

Wandfliesen

Dekorationselemente²

30 x 60 cm



30 x 90 cm¹

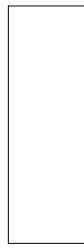

30 x 60 cm



30 x 90 cm¹



Circle

Circle

Nennmaß - cm/in	30 x 60 / 12 x 24	30 x 90 / 12 x 36	30 x 60 / 12 x 24	30 x 90 / 12 x 36			
Herstellmaß	297 x 597 x 6 mm	297 x 897 x 6 mm	297 x 597 x 6 mm	297 x 897 x 6 mm			
Oberfläche	strukturiert, steinmatt	strukturiert, steinmatt	strukturiert, steinmatt	strukturiert, steinmatt			
m ² - Stück	5,556	3,704	5,556	3,704			
m ² - kg	10,279	10,400	10,279	10,400			
Paket - Stück	13	8	13	8			
Paket - m ²	2,340	2,160	2,340	2,160			
Paket - kg	24,050	22,464	24,050	22,464			
Palette - m ²	112,311	51,836	112,311	51,836			
Palette - kg	1.154,400	539,136	1.154,400	539,136			
Produktnorm	BIII	BIII	BIII	BIII			
	203479H	323485H	203481H	323483H			
cotton V2	Preisgr. C107 (m ²)	Preisgr. C149 (m ²)	Preisgr. C116 (m ²)	Preisgr. C155 (m ²)			
	203480H	323486H	203482H	323484H			
smoke white V2	Preisgr. C107 (m ²)	Preisgr. C149 (m ²)	Preisgr. C116 (m ²)	Preisgr. C155 (m ²)			



² Abgabe der Dekorationselemente ausschließlich in vollen Kartons.

Mosaik^{1/2}

Bodenfliesen¹

Dekorations-
elemente¹

5 x 5 cm



30 x 60 cm

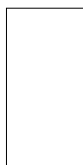

60 x 60 cm



60 x 120 cm^{3/4}

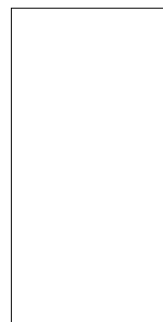

60 x 60 cm

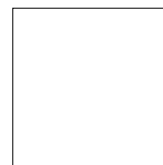

Bogen: 297 x 297 mm

Bodendekor Circle

	5 x 5 / 2 x 2	30 x 60 / 12 x 24	60 x 60 / 24 x 24	60 x 120 / 24 x 48	60 x 60 / 24 x 24	Nennmaß - cm/in
	47 x 47 x 9 mm	297 x 597 x 9 mm	597 x 597 x 9 mm	597 x 1197 x 9 mm	597 x 597 x 9 mm	Herstellmaß
	strukturiert, matt	strukturiert, matt	strukturiert, matt	strukturiert, matt	strukturiert, matt	Oberfläche
	11,111 Bögen	5,556	2,778	1,389	2,778	m ² - Stück
	19,833	19,907	20,371	21,132	20,371	m ² - kg
	12 Bögen	7	3	2	3	Paket - Stück
	1,080	1,260	1,080	1,441	1,080	Paket - m ²
	21,420	25,081	21,999	30,450	21,999	Paket - kg
	32,400	50,396	45,356	50,432	45,356	Palette - m ²
	642,600	1.003,240	923,958	1.065,750	923,958	Palette - kg
	Bla	Bla	Bla	Bla	Bla	Produktnorm
	R10/A+B	R10/A+B	R10/A+B	R10/A+B	R10/A+B	Trittsicherheit
	2	2	2	2	2	Belastung
	435901H	435906H	435911H	435916H	435921H	lime <input type="checkbox"/> V3
	Preisgr. C293 (m ²)	Preisgr. C125 (m ²)	Preisgr. C140 (m ²)	Preisgr. C152 (m ²)	Preisgr. C149 (m ²)	bronze grey <input type="checkbox"/> V3
	435902H	435907H	435912H	435917H	435922H	aluminium <input type="checkbox"/> V3
	Preisgr. C293 (m ²)	Preisgr. C125 (m ²)	Preisgr. C140 (m ²)	Preisgr. C152 (m ²)	Preisgr. C149 (m ²)	asphalt <input type="checkbox"/> V3
	435903H	435908H	435913H	435918H	435923H	blue steel <input type="checkbox"/> V3
	Preisgr. C293 (m ²)	Preisgr. C125 (m ²)	Preisgr. C140 (m ²)	Preisgr. C152 (m ²)	Preisgr. C149 (m ²)	
	435904H	435909H	435914H	435919H	435924H	
	Preisgr. C293 (m ²)	Preisgr. C125 (m ²)	Preisgr. C140 (m ²)	Preisgr. C152 (m ²)	Preisgr. C149 (m ²)	
	435905H	435910H	435915H	435920H	435925H	
	Preisgr. C293 (m ²)	Preisgr. C125 (m ²)	Preisgr. C140 (m ²)	Preisgr. C152 (m ²)	Preisgr. C149 (m ²)	



- ¹ Verklebung rückseitig auf Glasfasernetz
² Achtung: Sonderpalette. Keine Rücknahme, kein Umtausch.
³ Hohes Gewicht! Karton bitte nur zu Zweit transportieren.



Treppen-
fliese^{1/2}

30 x 120 cm



Sockel,
gerundet¹

7 x 60 cm



Terrassenplatte^{1/3}

60 x 60 cm



Nennmaß - cm/in	30 x 120 / 12 x 48	7 x 60 / 2 13/16 x 24	60 x 60 / 24 x 24				
Herstellmaß	297 x 1197 x 9 mm	70 x 597 x 9 mm	597 x 597 x 20 mm				
Oberfläche	strukturiert, matt	strukturiert, matt	strukturiert, matt				
m ² /m - Stück	0,833/m	1,667/m	2,778/m ²				
m ² /m - kg	6,341/m	1,357/m	45,273/m ²				
Paket - Stück	3	15	2				
Paket - m ² /m	3,601 m	8,998 m	0,720 m ²				
Paket - kg	22,836	12,210	32,594				
Palette - m ²			21,598				
Palette - kg			977,820				
Produktnorm	Bla	Bla	Bla				
Trittsicherheit	R10/A+B		R11/B				
Belastung	2		4				
lime V3	435930H Preisgr. C517 (St.)	435935H Preisgr. C440 (St.)	435926H Preisgr. C200 (m ²)				
bronze grey V3	435931H Preisgr. C517 (St.)	435936H Preisgr. C440 (St.)	435927H Preisgr. C200 (m ²)				
aluminium V3	435932H Preisgr. C517 (St.)	435937H Preisgr. C440 (St.)	435928H Preisgr. C200 (m ²)				
asphalt V3	435933H Preisgr. C517 (St.)	435938H Preisgr. C440 (St.)	435929H Preisgr. C200 (m ²)				
blue steel V3	435934H Preisgr. C517 (St.)	435939H Preisgr. C440 (St.)					



³ Hohes Gewicht! Karton bitte nur zu Zweit transportieren.







Innovativ und robust

Spezialisten leisten mehr. Das gilt auch für die keramischen Bodenplatten der Serie Ferrum, die eigens für die harten Anforderungen industrieller Betriebe entwickelt wurden. Die durchgefärbten, unglasierten Spaltplatten sind besonders trittsicher und beugen dadurch Arbeitsunfällen vor. Sie sind extrem robust und übertreffen die Druckfestigkeit von Beton oder Beschichtungsstoffen um ein Vielfaches. Ein technisch ausgefeiltes Zubehörprogramm, das Hohlkehlsöckel und Flachrinnen umfasst, erleichtert die Realisation betriebsspezifischer Komplettlösungen.

Lehr- und Versuchsanstalt für Wein- und Obstbau, Weinsberg, Deutschland / Architekt: Staatl. Hochbauamt / Foto: Andreas Freytag

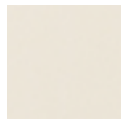

graubeige



grauweiß



steingrau



Bodenplatten 12,5 x 25 cm, eben, R10/A
Bodenplatten 12,5 x 25 cm, eben, R11/B



Hohlkehlsocbel, r = 20 mm
12,5 x 25 cm, eben

Gehrungspaar,
eben

Endstück, eben

Flachrinne, eben

Flachrinne mit Ablauf 1½", eben

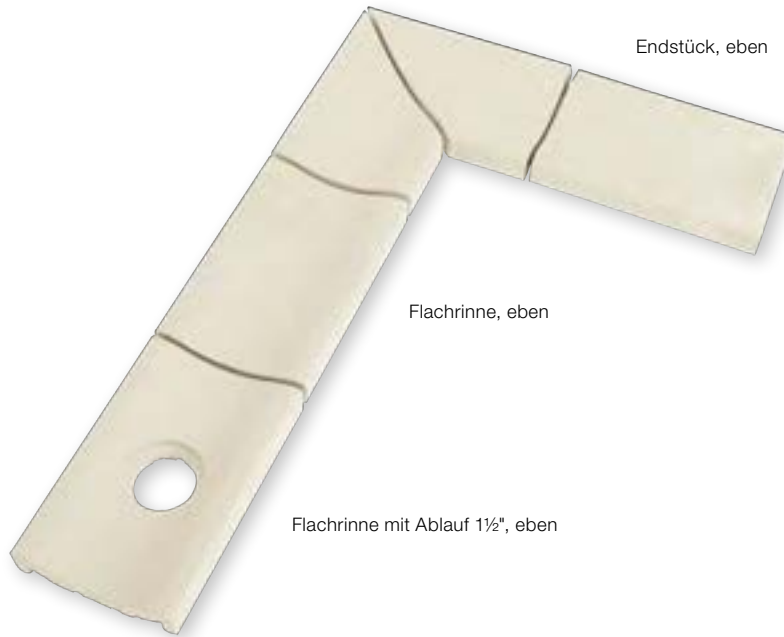

Bodenplatten

Hohlkehls-
sockel¹

12,5 x 25 cm



12,5 x 25 cm



25 x 12,5 cm



11 mm stark

20 mm stark

r= 20 mm

			1100	1110	4035		Formatnummer		
			12,5 x 25 / 5 x 10	12,5 x 25 / 5 x 10	12,5 x 25 / 5 x 10		Nennmaß - cm/in		
			115 x 240 x 11 mm	115 x 240 x 20 mm	125/9 x 240 x 11 mm		Herstellmaß		
			eben, matt	eben, matt	eben, matt		Oberfläche		
			33,000/m ²	33,000/m ²	4,000/m		m ² /m - Stück		
			22,869/m ²	41,679/m ²	3,420/m		m ² /m - kg		
			23	13	18		Paket - Stück		
			0,697 m ²	0,394 m ²	4,500 m		Paket - m ² /m		
			15,939	16,419	15,390		Paket - kg		
			58,545	33,091			Palette - m ²		
			1.338,876	1.379,196			Palette - kg		
			Alb	Alb	Alb		Produktnorm		
			siehe unten	siehe unten	siehe unten		Trittsicherheit		
			2	4			Belastung		
			R10/A	R10/A					
			900R-1100	900R-1110	<i>900R-4035</i>				
			Preisgr. A115 (m ²)	Preisgr. A211 (m ²)	<i>Preisgr. A434 (St.)</i>		graubeige	<input type="checkbox"/>	VO
			R11/B	R11/B					
			902R-1100	902R-1110	<i>902R-4035</i>				
			Preisgr. A115 (m ²)	Preisgr. A211 (m ²)	<i>Preisgr. A434 (St.)</i>		grauweiß	<input type="checkbox"/>	VO
			R11/B	R11/B					
			929R-1100	929R-1110	<i>929R-4035</i>				
			Preisgr. A115 (m ²)	Preisgr. A211 (m ²)	<i>Preisgr. A434 (St.)</i>		steingrau	<input type="checkbox"/>	VO



Flachrinnensystem (Muldentiefe 15 mm)

25 x 15,6 cm

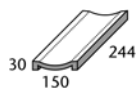

25 x 15,6 cm²

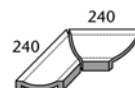

25 x 15,6 cm



Flachrinne

Flachrinne mit
Ablauf 1 1/2"

Flachrinne
Gehrungspaar

Flachrinne Endstück

			54420	54421	54422	54423	Formatnummer		
			25 x 15,6 / 10 x 6 1/4	25 x 15,6 / 10 x 6 1/4		25 x 15,6 / 10 x 6 1/4	Nennmaß - cm/in		
			244 x 150 x 30 mm	244 x 150 x 30 mm	(2x) 240 x 150 x 30 mm	244 x 150 x 30 mm	Herstellmaß		
			eben, matt	eben, matt	eben, matt	eben, matt	Oberfläche		
			4,000				m - Stück		
			1,800/Stück	1,530/Stück	3,030/Paar	1,950/Stück	m/St. - kg		
			8 Stück	8 Stück	4 Paar	8 Stück	Paket - Stück		
			2,000				Paket - m		
			14,400	12,240	12,120	15,600	Paket - kg		
							Palette - m		
							Palette - kg		
			Alb	Alb	Alb	Alb	Produktnorm		
			R10/A	R10/A	R10/A	R10/A	Trittsicherheit		
			900-54420	900-54421	900-54422	900-54423			
			Preisgr. A458 (St.)	Preisgr. A560 (St.)	Preisgr. A581 (Paar)	Preisgr. A560 (St.)	graubeige	<input type="checkbox"/>	VO



¹ Passender Einsatz für den Ablauf: Art.-Nr. 182 - Lieferprogramm Pool + Spa 2025 (Einbau vor Verlegung)

Schenkelplatten 12,5 x 25 cm auf Anfrage geklebt machbar. Preisstellung wird objektspezifisch kalkuliert.

Für das Flachrinnensystem wird kein Palettenrabatt gewährt. Oberfläche mit einer geeigneten Imprägnierung behandeln! Siehe technische Informationen S. 527







Frisch und modern

Fresh bietet eine stimmige Palette an modernen, frischen Farben in den beliebten Mosaikformaten 2,5 x 2,5 cm und 5 x 5 cm, mit denen individuelle, aber zugleich auch unkompliziert zu realisierende Gestaltungen möglich werden. Besonders praktisch ist dabei: Zu den Fliesen gibt es farblich passende rutschhemmende Mosaik in R10/B und R11/C.

Rendering

Fresh: moderne Klarheit für individuelle Gestaltung

snow white	warm grey mix	desert sand-mix	taupe-mix	white grey mix	silver grey mix	light grey-mix	medium grey-mix	midnight black-mix	graphite black mix	deep blue mix	caribbean-blue-mix
------------	---------------	-----------------	-----------	----------------	-----------------	----------------	-----------------	--------------------	--------------------	---------------	--------------------

2,5 x 2,5 cm

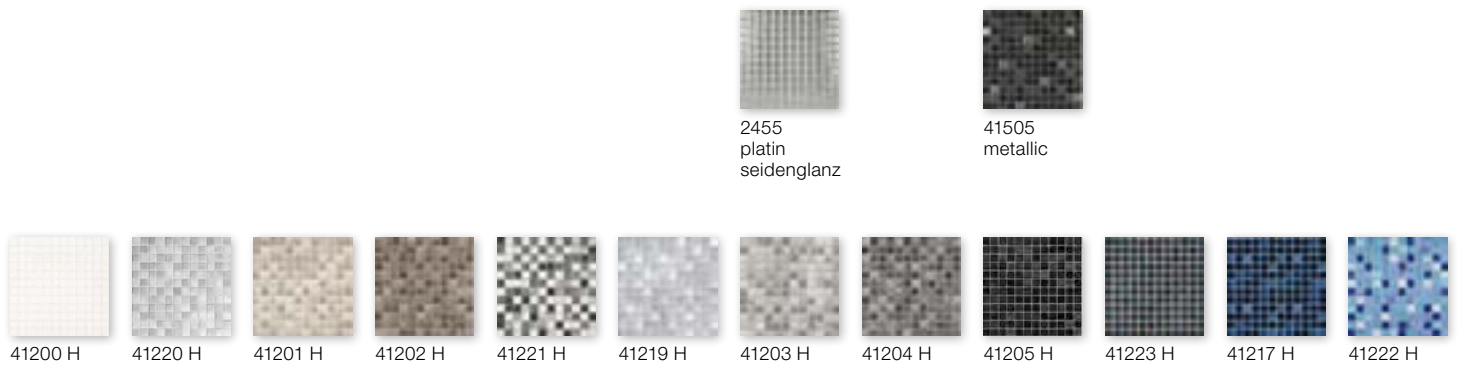

2,5 x 2,5 cm non-slip R10/B



5 x 5 cm non-slip R10/B & R11/C

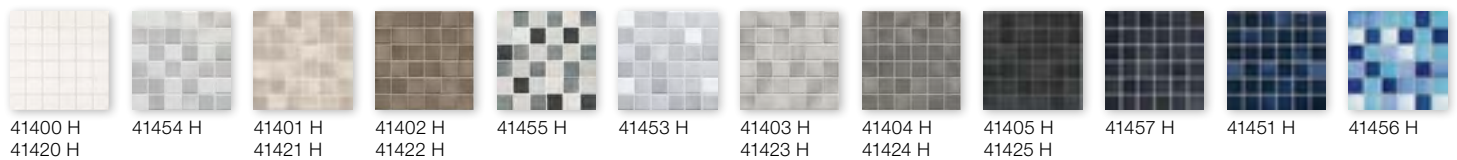

denim blue-mix	light blue-mix	pacific blue-mix	midnight blue-mix	vivid violet-mix	sunset orange-mix	coral red-mix	brick red mix	mystic red-mix	forest green mix	lime green-mix	sunshine yellow-mix
-------------------	-------------------	---------------------	----------------------	---------------------	----------------------	------------------	------------------	-------------------	---------------------	-------------------	------------------------

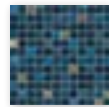

41509
metallic

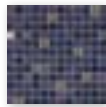

41510
metallic



41513
metallic



2452
gold
seidenglanz

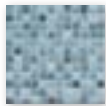

41206 H



41207 H



41208 H



41209 H



41210 H



41211 H

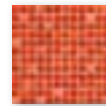

41212 H

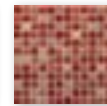

41218 H



41213 H



41216 H



41214 H



41215 H



41306 H



41307 H



41308 H



41309 H



41310 H



41311 H



41312 H

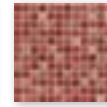

41318 H



41313 H



41316 H



41314 H



41315 H



41406 H



41407 H



41408 H



41409 H



41410 H

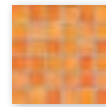

41411 H



41412 H

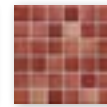

41452 H

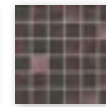

41313 H

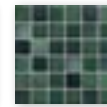

41450 H



41414 H



41415 H

Mosaik 2,5 x 2,5 cm



Mosaikbogen 30 x 30 cm
snow white, eben,
Mosaikbogen 30 x 30 cm
snow white, eben, R10/B

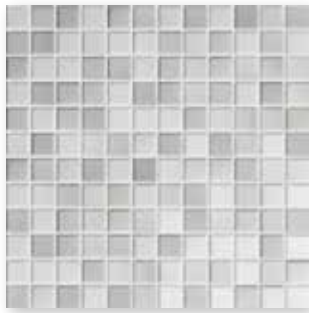

Mosaikbogen 30 x 30 cm,
warm grey-mix, eben,
Mosaikbogen 30 x 30 cm,
warm grey-mix, eben, R10/B



Mosaikbogen 30 x 30 cm
desert sand-mix, eben,
Mosaikbogen 30 x 30 cm
desert sand-mix, eben, R10/B



Mosaikbogen 30 x 30 cm
taupe-mix, eben,
Mosaikbogen 30 x 30 cm
taupe-mix, eben, R10/B



Mosaikbogen 30 x 30 cm
white grey-mix, eben,
Mosaikbogen 30 x 30 cm
white grey-mix, eben, R10/B

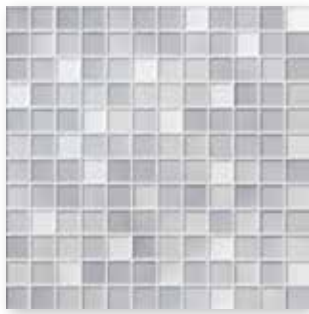

Mosaikbogen 30 x 30 cm
silver grey-mix, eben,
Mosaikbogen 30 x 30 cm
silver grey-mix, eben, R10/B

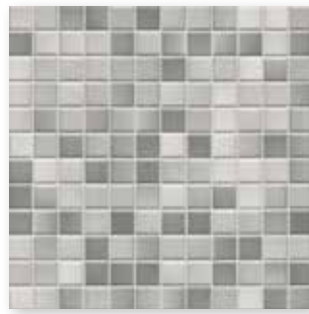

Mosaikbogen 30 x 30 cm
light grey-mix, eben,
Mosaikbogen 30 x 30 cm
light grey-mix, eben, R10/B

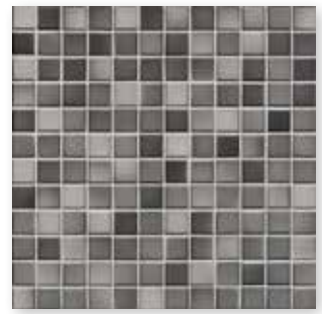

Mosaikbogen 30 x 30 cm
medium grey-mix, eben,
Mosaikbogen 30 x 30 cm
medium grey-mix, eben, R10/B

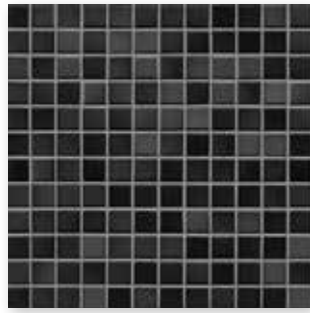

Mosaikbogen 30 x 30 cm
midnight black-mix, eben,
Mosaikbogen 30 x 30 cm
midnight black-mix, eben, R10/B

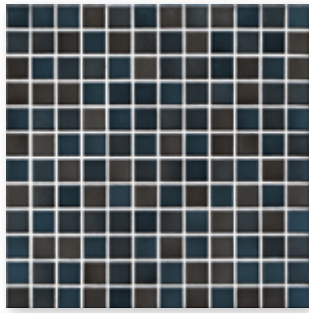

Mosaikbogen 30 x 30 cm
graphite black-mix, eben,
Mosaikbogen 30 x 30 cm
graphite black-mix, eben, R10/B



Mosaikbogen 30 x 30 cm
deep blue-mix, eben,
Mosaikbogen 30 x 30 cm
deep blue-mix, eben, R10/B

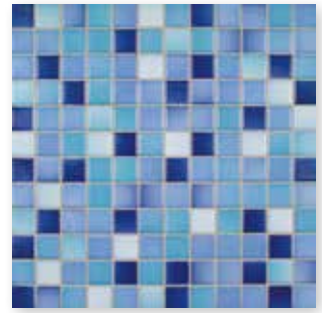

Mosaikbogen 30 x 30 cm
caribbean-blue-mix, eben,
Mosaikbogen 30 x 30 cm
caribbean-blue-mix, eben, R10/B

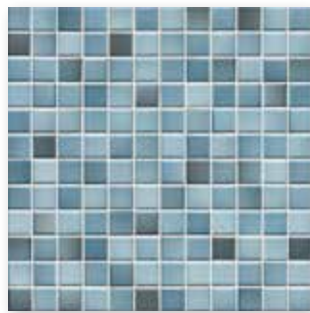

Mosaikbogen 30 x 30 cm
denim blue-mix, eben,
Mosaikbogen 30 x 30 cm
denim blue-mix, eben, R10/B



Mosaikbogen 30 x 30 cm,
light blue-mix, eben,
Mosaikbogen 30 x 30 cm
light blue-mix, eben, R10/B

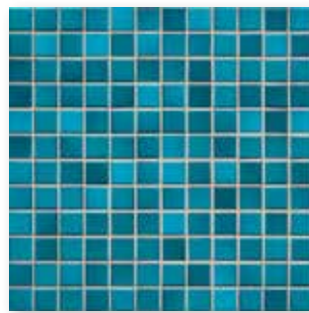

Mosaikbogen 30 x 30 cm
pacific blue-mix, eben,
Mosaikbogen 30 x 30 cm
pacific blue-mix, eben, R10/B

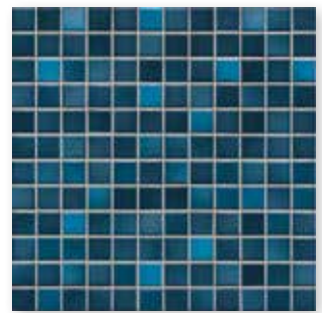

Mosaikbogen 30 x 30 cm
midnight blue-mix, eben,
Mosaikbogen 30 x 30 cm
midnight blue-mix, eben, R10/B



Mosaikbogen 30 x 30 cm
vivid violet-mix, eben,
Mosaikbogen 30 x 30 cm
vivid violet-mix, eben, R10/B

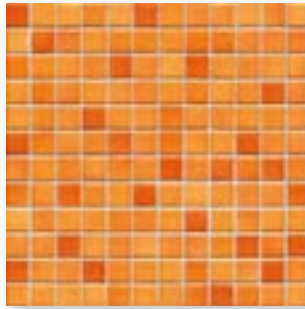

Mosaikbogen 30 x 30 cm
sunset-orange-mix, eben,
Mosaikbogen 30 x 30 cm
sunset-orange-mix, eben, R10/B

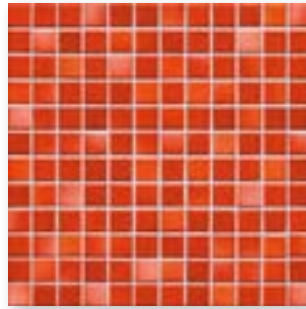

Mosaikbogen 30 x 30 cm
coral red-mix, eben,
Mosaikbogen 30 x 30 cm
coral red-mix, eben, R10/B

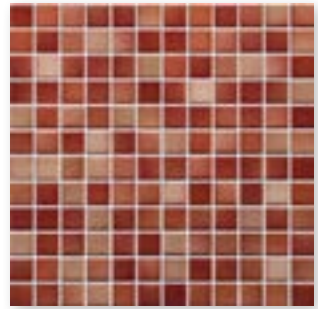

Mosaikbogen 30 x 30 cm
brick red-mix, eben,
Mosaikbogen 30 x 30 cm
brick red-mix, eben, R10/B

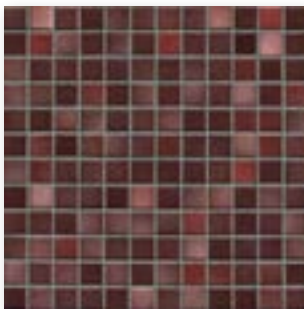

Mosaikbogen 30 x 30 cm
mystic-red-mix, eben,
Mosaikbogen 30 x 30 cm
mystic-red-mix, eben, R10/B

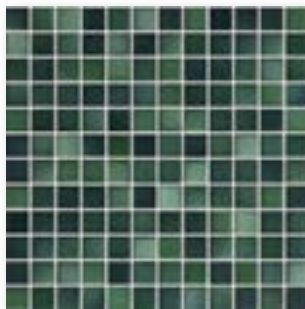

Mosaikbogen 30 x 30 cm
forest green-mix, eben,
Mosaikbogen 30 x 30 cm
forest green-mix, eben, R10/B

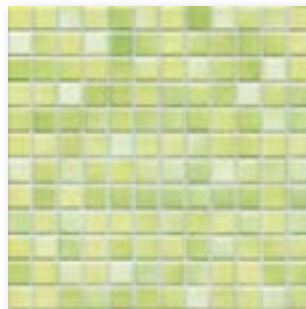

Mosaikbogen 30 x 30 cm
lime green-mix, eben,
Mosaikbogen 30 x 30 cm
lime green-mix, eben, R10/B

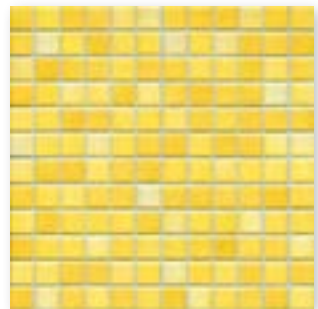

Mosaikbogen 30 x 30 cm
sunshine yellow-mix, eben,
Mosaikbogen 30 x 30 cm
sunshine yellow-mix, eben, R10/B

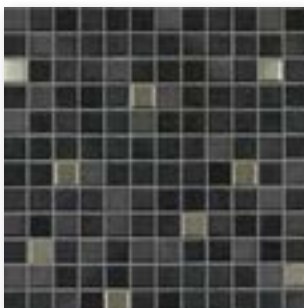

Mosaikbogen 30 x 30 cm
midnight black-mix metallic, eben



Mosaikbogen 30 x 30 cm
midnight blue-mix metallic, eben

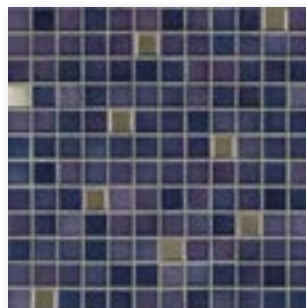

Mosaikbogen 30 x 30 cm
vivid violet-mix metallic, eben

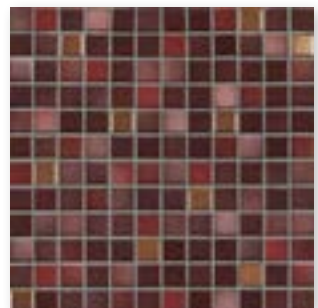

Mosaikbogen 30 x 30 cm
mystic red-mix metallic, eben

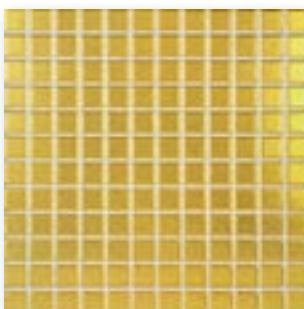

Mosaikbogen 30 x 30 cm, gold,
eben *

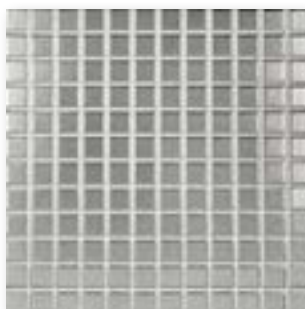

Mosaikbogen 30 x 30 cm, platin,
eben *

* Zur Vermeidung des Abriebs der Oberflächenbeschichtung ist von einer Bodenbelegung oder sonstiger vergleichbarer Beanspruchung zwingend abzugehen.



Rückseitig thermoplastisch verklebte Mosaike von Agrob Buchtal sind nicht nur im Trockenbereich, sondern auch bedenkenlos im Unterwasserbereich (z. B. Schwimmbecken/Whirlpool) sowie im dauernassbelasteten Bereich einsetzbar.



Farbverlauf 2,5 x 2,5 cm

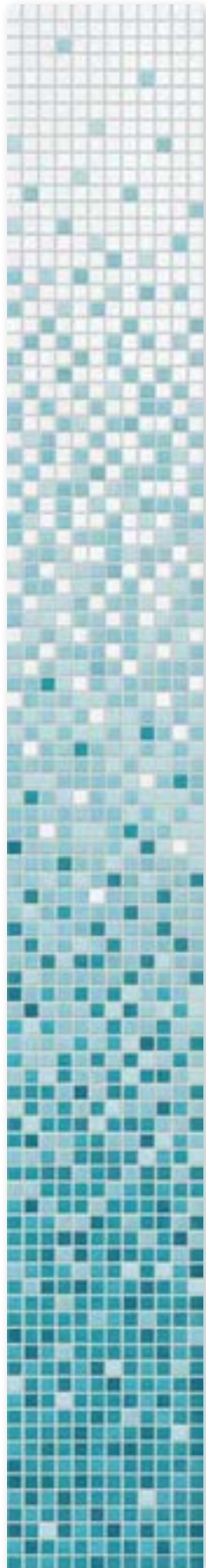

41520H
aqua glänzend

Herstellmaß ohne Außenfuge:
297 x 2376 x 6,5 mm

Weitere Beispiele

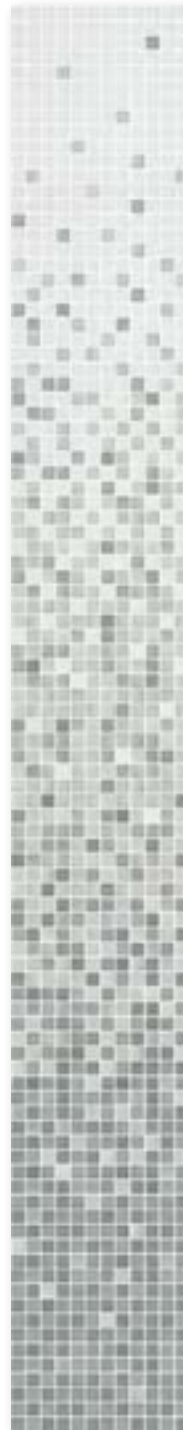

Farben aus Fresh können im Standard Farbverlauf beliebig ohne Aufpreis ausgetauscht werden. Eine individuelle Gestaltung von Farbverläufen bezüglich der Maße und Farbverhältnisse prüfen wir gerne als Sonderproduktion.

Kennen Sie schon unseren Mosaic Designer auf unserer Website www.agrob-buchtal.de?
Hier haben Sie die Möglichkeit Ihre individuellen Farbverläufe, Mosaikmischungen und Bildverlegungen zu gestalten.



Mosaik 5 x 5 cm, non-slip

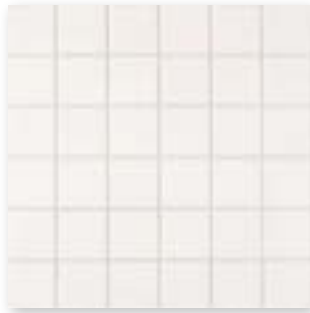

Mosaikbogen 30 x 30 cm
snow white, eben, R10/B,
Mosaikbogen 30 x 30 cm
snow white, eben, R11/C



Mosaikbogen 30 x 30 cm
warm grey-mix, eben, R10/B,
Mosaikbogen 30 x 30 cm
warm grey-mix, eben, R11/C



Mosaikbogen 30 x 30 cm
desert sand-mix, eben, R10/B,
Mosaikbogen 30 x 30 cm
desert sand-mix, eben, R11/C



Mosaikbogen 30 x 30 cm
taupe-mix, eben, R10/B,
Mosaikbogen 30 x 30 cm
taupe-mix, eben, R11/C



Mosaikbogen 30 x 30 cm
white grey-mix, eben, R10/B



Mosaikbogen 30 x 30 cm
silver grey-mix, eben, R10/B



Mosaikbogen 30 x 30 cm
light grey-mix, eben, R10/B,
Mosaikbogen 30 x 30 cm
light grey-mix, eben, R11/C



Mosaikbogen 30 x 30 cm
medium grey-mix, eben, R10/B,
Mosaikbogen 30 x 30 cm
medium grey-mix, eben, R11/C

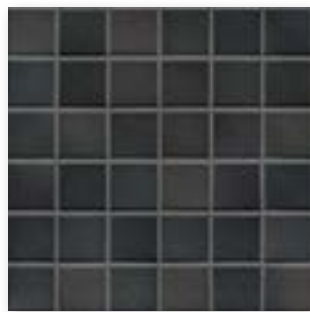

Mosaikbogen 30 x 30 cm
midnight black-mix, eben, R10/B,
Mosaikbogen 30 x 30 cm
midnight black-mix, eben, R11/C



Mosaikbogen 30 x 30 cm
graphite black-mix, eben, R10/B



Mosaikbogen 30 x 30 cm
deep blue-mix, eben, R10/B

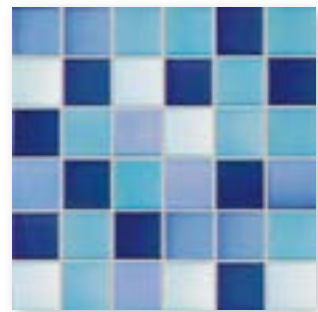

Mosaikbogen 30 x 30 cm
caribbean-blue-mix, eben, R10/B



Rückseitig thermoplastisch verklebte Mosaik von Agrob Buchtal sind nicht nur im Trockenbereich, sondern auch bedenkenlos im Unterwasserbereich (z. B. Schwimmbecken/Whirlpool) sowie im dauernassbelasteten Bereich (z. B. Beckenumgänge/Duschen) einsetzbar.



Mosaikbogen 30 x 30 cm
denim blue-mix, eben, R10/B,
Mosaikbogen 30 x 30 cm
denim blue-mix, eben, R11/C



Mosaikbogen 30 x 30 cm
light blue-mix, eben, R10/B,
Mosaikbogen 30 x 30 cm
light blue-mix, eben, R11/C



Mosaikbogen 30 x 30 cm
pacific blue-mix, eben, R10/B,
Mosaikbogen 30 x 30 cm
pacific blue-mix, eben, R11/C



Mosaikbogen 30 x 30 cm
midnight blue-mix, eben, R10/B,
Mosaikbogen 30 x 30 cm
midnight blue-mix, eben, R11/C



Mosaikbogen 30 x 30 cm
vivid violet-mix, eben, R10/B,
Mosaikbogen 30 x 30 cm
vivid violet-mix, eben, R11/C

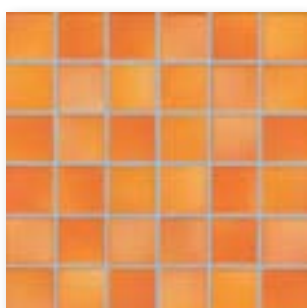

Mosaikbogen 30 x 30 cm
sunset orange-mix, eben, R10/B,
Mosaikbogen 30 x 30 cm
sunset orange-mix, eben, R11/C

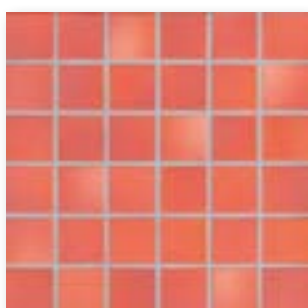

Mosaikbogen 30 x 30 cm
coral red-mix, eben, R10/B,
Mosaikbogen 30 x 30 cm
coral red-mix, eben, R11/C



Mosaikbogen 30 x 30 cm
brick red-mix, eben, R10/B

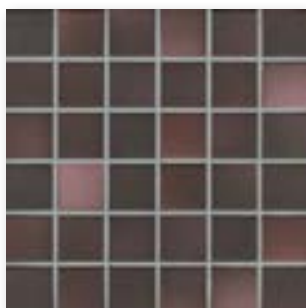

Mosaikbogen 30 x 30 cm
mystic red-mix, eben, R10/B,
Mosaikbogen 30 x 30 cm
mystic red-mix, eben, R11/C



Mosaikbogen 30 x 30 cm
forest green-mix, eben, R10/B

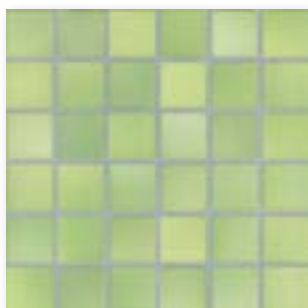

Mosaikbogen 30 x 30 cm
lime green-mix, eben, R10/B,
Mosaikbogen 30 x 30 cm
lime green-mix, eben, R11/C

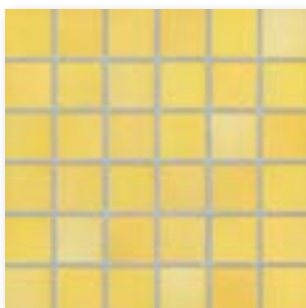

Mosaikbogen 30 x 30 cm
sunshine yellow-mix, eben, R10/B,
Mosaikbogen 30 x 30 cm
sunshine yellow-mix, eben, R11/C

Mosaik

Farbverlauf¹

2,5 x 2,5 cm



2,5 x 2,5 cm



Bogen: 297 x 297 mm

Bogen: 297 x 297 mm

Nennmaß - cm/in	2,5 x 2,5 / 1 x 1	2,5 x 2,5 / 1 x 1				
Herstellmaß	23 x 23 x 6,5 mm	23 x 23 x 6,5 mm				
Oberfläche	eben, glänzend	eben, glänzend				
m ² - Stück	11 Bögen	11 Bögen				
m ² - kg	12,100					
Paket - Stück	11 Bögen	8 Bögen				
Paket - m ²	1,000	0,800				
Paket - kg	12,100	8,800				
Palette - m ²	48,000					
Palette - kg	580,800					
Produktnorm	Blb	Blb				
Trittsicherheit						
Belastung	1	1				
	3					
snow white <input type="checkbox"/> V2	41200H Preisgr. A229 (m ²)					
desert sand-mix <input type="checkbox"/> V2	41201H Preisgr. A229 (m ²)					
taupe-mix <input type="checkbox"/> V2	41202H Preisgr. A229 (m ²)					
light grey-mix <input type="checkbox"/> V2	41203H Preisgr. A229 (m ²)					
medium grey-mix <input type="checkbox"/> V2	41204H Preisgr. A229 (m ²)					
midnight black-mix <input type="checkbox"/> V2	2 41205H Preisgr. A229 (m ²)					
denim blue-mix <input type="checkbox"/> V2	3 41206H Preisgr. A250 (m ²)					
light blue-mix <input type="checkbox"/> V2	3 41207H Preisgr. A250 (m ²)					
pacific blue-mix <input type="checkbox"/> V2	3 41208H Preisgr. A250 (m ²)					
midnight blue-mix <input type="checkbox"/> V2	3 41209H Preisgr. A250 (m ²)					
vivid violet-mix <input type="checkbox"/> V2	2 41210H Preisgr. A250 (m ²)					
sunset orange-mix <input type="checkbox"/> V2	3 41211H Preisgr. A250 (m ²)					
coral red-mix <input type="checkbox"/> V2	3 41212H Preisgr. A250 (m ²)					
mystic red-mix <input type="checkbox"/> V2	2 41213H Preisgr. A250 (m ²)					
lime green-mix <input type="checkbox"/> V2	3 41214H Preisgr. A250 (m ²)					
sunshine <input type="checkbox"/> V2	3 41215H Preisgr. A250 (m ²)					
yellow-mix <input type="checkbox"/> V2						
aqua <input type="checkbox"/> V2						
glänzend <input type="checkbox"/> V2		41520H Preisgr. A750 (St.)				

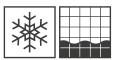

¹ Herstellmaß ohne Außenfuge: 297 x 2376 mm
Preisangabe bezieht sich auf den Farbverlauf = 8 Bögen
Farbverläufe können individuell gestaltet werden. Gerne prüfen wir die Möglichkeiten einer solchen Sonderproduktion im Einzelfall.

Kennen Sie schon unseren Mosaic Designer auf unserer Website www.agrob-buchtal.de?
Hier haben Sie die Möglichkeit Ihre individuellen Farbverläufe, Mosaikmischungen und Bildverlegungen zu gestalten.

Mosaik

2,5 x 2,5 cm

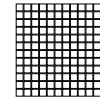

Bogen: 297 x 297 mm



					2,5 x 2,5 / 1 x 1		Nennmaß - cm/in
					23 x 23 x 6,5 mm		Herstellmaß
					eben, glänzend		Oberfläche
					11 Bögen		m ² - Stück
					12,100		m ² - kg
					11 Bögen		Paket - Stück
					1,000		Paket - m ²
					12,100		Paket - kg
					48,000		Palette - m ²
					580,800		Palette - kg
					Blb		Produktnorm
					1		Trittsicherheit
							Belastung
					41216H	2	forest green mix <input type="checkbox"/> V2
					Preisgr. A250 (m ²)		
					41217H	2	deep blue mix <input type="checkbox"/> V2
					Preisgr. A250 (m ²)		
					41218H	2	brick red mix <input type="checkbox"/> V2
					Preisgr. A250 (m ²)		
					41219H	3	silver grey mix <input type="checkbox"/> V2
					Preisgr. A250 (m ²)		
					41220H	3	warm grey mix <input type="checkbox"/> V2
					Preisgr. A250 (m ²)		
					41221H	2	white grey mix <input type="checkbox"/> V2
					Preisgr. A250 (m ²)		
					41222H	2	caribbean-blue-mix <input type="checkbox"/> V2
					Preisgr. A250 (m ²)		
					41223H	2	graphite black mix <input type="checkbox"/> V2
					Preisgr. A250 (m ²)		
					41505³		midnight black-mix
					Preisgr. A458 (St.)		metallic glänzend <input type="checkbox"/> V2
					41509³		midnight blue-mix
					Preisgr. A458 (St.)		metallic glänzend <input type="checkbox"/> V2
					41510³		vivid violet-mix
					Preisgr. A458 (St.)		metallic glänzend <input type="checkbox"/> V2
					41513^{1/3}	1	mystic red-mix
					Preisgr. A458 (St.)		metallic glänzend <input type="checkbox"/> V2
					2452^{2/3}		gold
					Preisgr. A394 (m ²)		seidenglanz <input type="checkbox"/> V1
					2455^{2/3}		platin
					Preisgr. A394 (m ²)		seidenglanz <input type="checkbox"/> V1

¹ Nicht oder nur bedingt säure- und laugenbeständig

² Zur Vermeidung des Abriebs der Oberflächenbeschichtung ist von einer Bodenbelegung oder sonstiger vergleichbarer Beanspruchung zwingend abzusehen.

³ ohne Hytect-Veredelung



Mosaik

2,5 x 2,5 cm

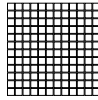

5 x 5 cm

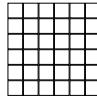

5 x 5 cm

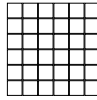

Bogen: 297 x 297 mm

Bogen: 297 x 297 mm

Bogen: 297 x 297 mm



Nennmaß - cm/in	2,5 x 2,5 / 1 x 1	5 x 5 / 2 x 2	5 x 5 / 2 x 2			
Herstellmaß	23 x 23 x 6,5 mm	47 x 47 x 6,5 mm	47 x 47 x 6,5 mm			
Oberfläche	eben, matt	eben, matt	eben, matt			
m ² - Stück	11 Bögen	11 Bögen	11 Bögen			
m ² - kg	12,100	12,331	12,331			
Paket - Stück	11 Bögen	11 Bögen	11 Bögen			
Paket - m ²	1,000	1,000	1,000			
Paket - kg	12,100	12,331	12,331			
Palette - m ²	48,000	64,000	64,000			
Palette - kg	580,800	789,184	789,184			
Produktnorm	Blb	Blb	Blb			
Trittsicherheit	R10/B	R10/B	R11/C			
Belastung	1	1	1			
	4	4	4			
snow white <input type="checkbox"/>	41300H Preisgr. A238 (m ²)	41400H-73 Preisgr. A196 (m ²)	41420H Preisgr. A211 (m ²)			
desert sand-mix <input type="checkbox"/>	41301H Preisgr. A238 (m ²)	41401H-73 Preisgr. A196 (m ²)	41421H Preisgr. A211 (m ²)			
taupe-mix <input type="checkbox"/>	3 41302H Preisgr. A238 (m ²)	41402H-73 Preisgr. A196 (m ²)	41422H Preisgr. A211 (m ²)			
light grey-mix <input type="checkbox"/>	4 41303H Preisgr. A238 (m ²)	41403H-73 Preisgr. A196 (m ²)	41423H Preisgr. A211 (m ²)			
medium grey-mix <input type="checkbox"/>	4 41304H Preisgr. A238 (m ²)	41404H-73 Preisgr. A196 (m ²)	41424H Preisgr. A211 (m ²)			
midnight black-mix <input type="checkbox"/>	3 41305H Preisgr. A238 (m ²)	41405H-73 Preisgr. A196 (m ²)	41425H Preisgr. A211 (m ²)			
denim blue-mix <input type="checkbox"/>	3 41306H Preisgr. A259 (m ²)	41406H Preisgr. A217 (m ²)	41426H Preisgr. A229 (m ²)			
light blue-mix <input type="checkbox"/>	3 41307H Preisgr. A259 (m ²)	41407H Preisgr. A217 (m ²)	41427H Preisgr. A229 (m ²)			
pacific blue-mix <input type="checkbox"/>	4 41308H Preisgr. A259 (m ²)	41408H Preisgr. A217 (m ²)	41428H Preisgr. A229 (m ²)			
midnight blue-mix <input type="checkbox"/>	3 41309H Preisgr. A259 (m ²)	41409H Preisgr. A217 (m ²)	41429H Preisgr. A229 (m ²)			
vivid violet-mix <input type="checkbox"/>	3 41310H Preisgr. A259 (m ²)	41410H Preisgr. A217 (m ²)	41430H Preisgr. A229 (m ²)			
sunset orange-mix <input type="checkbox"/>	4 41311H Preisgr. A259 (m ²)	41411H Preisgr. A217 (m ²)	41431H Preisgr. A229 (m ²)			
coral red-mix <input type="checkbox"/>	3 41312H Preisgr. A259 (m ²)	41412H Preisgr. A217 (m ²)	41432H Preisgr. A229 (m ²)			
mystic red-mix <input type="checkbox"/>	3 41313H Preisgr. A259 (m ²)	41413H Preisgr. A217 (m ²)	41433H Preisgr. A229 (m ²)			
lime green-mix <input type="checkbox"/>	3 41314H Preisgr. A259 (m ²)	41414H Preisgr. A217 (m ²)	41434H Preisgr. A229 (m ²)			
sunshine yellow-mix <input type="checkbox"/>	4 41315H Preisgr. A259 (m ²)	41415H Preisgr. A217 (m ²)	41435H Preisgr. A229 (m ²)			
forest green mix <input type="checkbox"/>	3 41316H Preisgr. A259 (m ²)	41450H Preisgr. A217 (m ²)				
deep blue mix <input type="checkbox"/>	2 41317H Preisgr. A259 (m ²)	41451H Preisgr. A217 (m ²)				
brick red mix <input type="checkbox"/>	3 41318H Preisgr. A259 (m ²)	41452H Preisgr. A217 (m ²)				
silver grey mix <input type="checkbox"/>	4 41319H Preisgr. A259 (m ²)	41453H Preisgr. A217 (m ²)				
warm grey mix <input type="checkbox"/>	4 41320H Preisgr. A259 (m ²)	41454H Preisgr. A217 (m ²)				
white grey mix <input type="checkbox"/>	3 41321H Preisgr. A259 (m ²)	41455H Preisgr. A217 (m ²)				
carribbean blue mix <input type="checkbox"/>	4 41322H Preisgr. A259 (m ²)	41456H Preisgr. A217 (m ²)				
graphite black mix <input type="checkbox"/>	3 41323H Preisgr. A259 (m ²)	41457H Preisgr. A217 (m ²)				

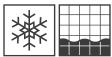



Hallenbad, Höxter, Deutschland / Architekt: Hooper Architects / Serien: Fresh, Quarzit / Foto: Jochen Stüber







Hommage ans Handwerk

Die Kollektion Karl interpretiert Handwerkliches und ursprüngliche Glasuren außergewöhnlich kreativ. Durch die Art der Glasur und die Rohstoff-Rezeptur entstehen im Brennvorgang jedes Mal unterschiedliche Fliesenbilder, die – in Fläche verlegt – authentische und elementare Anziehungskraft ausstrahlen: Sinnbild für einen Weg des einfachen Lebens mit Fokus aufs Wesentliche. Die glasierte Version empfiehlt sich vornehmlich für die Wandgestaltung, die steinmatte dank Rutschhemmung R10/B zusätzlich für den Boden. Mit der 2,5 x 2,5 cm-Variante lassen sich besonders effektiv größere Flächen, Säulen oder andere Baukörper gestalten. Wie ein maßgeschneidertes keramisches Kleid. Als passende Bodenfliese empfiehlt sich die Serie Stories.

Studioaufnahme / Architekt: VSBL, Belgrad, Serbien
Foto: Jochen Stüber

Mosaik 2,5 x 2,5 cm



Mosaikbogen 30 x 30 cm
white strukturiert,
Mosaikbogen 30 x 30 cm
white, strukturiert, R10/B



Mosaikbogen 30 x 30 cm
nude, strukturiert,
Mosaikbogen 30 x 30 cm
nude, strukturiert, R10/B

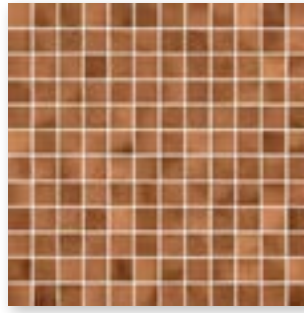

Mosaikbogen 30 x 30 cm
terra, strukturiert,
Mosaikbogen 30 x 30 cm
terra, strukturiert, R10/B



Mosaikbogen 30 x 30 cm
indigo, strukturiert,
Mosaikbogen 30 x 30 cm
indigo, strukturiert, R10/B

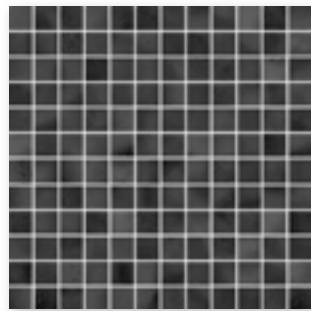

Mosaikbogen 30 x 30 cm
black, strukturiert,
Mosaikbogen 30 x 30 cm
black, strukturiert, R10/B



Rückseitig thermoplastisch verklebte Mosaike von Agrob Buchtal sind nicht nur im Trockenbereich, sondern auch bedenkenlos im Unterwasserbereich (z. B. Schwimmbecken/Whirlpool) sowie im dauernassbelasteten Bereich einsetzbar.

Mosaik 10 x 10 cm



Mosaikbogen 30 x 30 cm
white, strukturiert,
Mosaikbogen 30 x 30 cm
white, strukturiert, R10/B



Mosaikbogen 30 x 30 cm
nude, strukturiert,
Mosaikbogen 30 x 30 cm
nude, strukturiert, R10/B



Mosaikbogen 30 x 30 cm
terra, strukturiert,
Mosaikbogen 30 x 30 cm
terra, strukturiert, R10/B



Mosaikbogen 30 x 30 cm
indigo, strukturiert,
Mosaikbogen 30 x 30 cm
indigo, strukturiert, R10/B

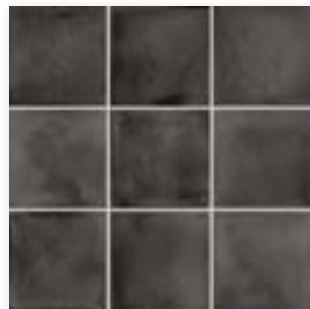

Mosaikbogen 30 x 30 cm
black, strukturiert,
Mosaikbogen 30 x 30 cm
black, strukturiert, R10/B



Mosaikbogen 30 x 30 cm
forest, strukturiert,
Mosaikbogen 30 x 30 cm
forest, strukturiert, R10/B



Mosaikbogen 30 x 30 cm
grey green, strukturiert,
Mosaikbogen 30 x 30 cm
grey green, strukturiert, R10/B



Mosaikbogen 30 x 30 cm
grey, strukturiert,
Mosaikbogen 30 x 30 cm
grey, strukturiert, R10/B



Mosaikbogen 30 x 30 cm
aqua, strukturiert,
Mosaikbogen 30 x 30 cm
aqua, strukturiert, R10/B



Mosaikbogen 30 x 30 cm
ocean blue, strukturiert,
Mosaikbogen 30 x 30 cm
ocean blue, strukturiert, R10/B

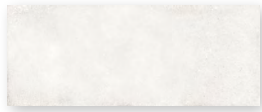

Wandfliese 10 x 25 cm
white, strukturiert



Wandfliese 10 x 25 cm
nude, strukturiert

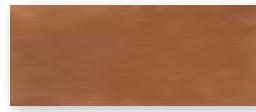

Wandfliese 10 x 25 cm
terra, strukturiert



Wandfliese 10 x 25 cm
indigo, strukturiert



Wandfliese 10 x 25 cm
black, strukturiert



Wandfliese 10 x 25 cm
forest, strukturiert



Wandfliese 10 x 25 cm
grey green, strukturiert



Wandfliese 10 x 25 cm
grey, strukturiert

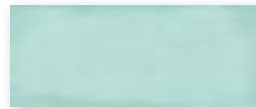

Wandfliese 10 x 25 cm
aqua, strukturiert

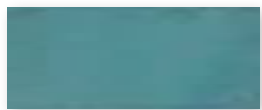

Wandfliese 10 x 25 cm
ocean blue, strukturiert

Mosaik¹

Wand-
fliese

2,5 x 2,5 cm

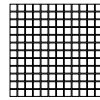

2,5 x 2,5 cm

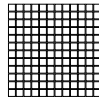

10 x 10 cm

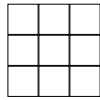

10 x 10 cm

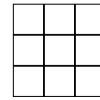

10 x 25 cm



Bogen: 297 x 297 mm

Bogen: 297 x 297 mm

Bogen: 297 x 297 mm

Bogen: 297 x 297 mm

	2,5 x 2,5 / 1 x 1	2,5 x 2,5 / 1 x 1	10 x 10 / 4 x 4	10 x 10 / 4 x 4	10 x 25 / 4 x 10	Nennmaß - cm/in
	23 x 23 x 6,5 mm	23 x 23 x 6,5 mm	97 x 97 x 6,5 mm	97 x 97 x 6,5 mm	97 x 247 x 6,5 mm	Herstellmaß
	strukturiert, glänzend	strukturiert, matt	strukturiert, glänzend	strukturiert, matt	strukturiert, glänzend	Oberfläche
	11 Bögen	11 Bögen	11 Bögen	11 Bögen	40,000	m ² - Stück
	12,100	12,100	13,101	13,101	12,560	m ² - kg
	11 Bögen	11 Bögen	11 Bögen	11 Bögen	27	Paket - Stück
	1,000	1,000	1,000	1,000	0,675	Paket - m ²
	12,100	12,100	13,101	13,101	8,478	Paket - kg
	48,000	48,000	64,000	64,000	86,400	Palette - m ²
	580,800	580,800	838,464	838,464	1.058,184	Palette - kg
	Bla (GL)	Bla (UGL)	Bla (GL)	Bla (UGL)	Bla (GL)	Produktnorm
		R10/B		R10/B		Trittsicherheit
	1	1	1	1	1	Belastung
	47050H	47075H	47250H	47275H	47650H	white <input type="checkbox"/> V3
	Preisgr. A244 (m ²)	Preisgr. A250 (m ²)	Preisgr. A139 (m ²)	Preisgr. A163 (m ²)	Preisgr. A181 (m ²)	
	47051H	47076H	47251H	47276H	47651H	nude <input type="checkbox"/> V3
	Preisgr. A244 (m ²)	Preisgr. A250 (m ²)	Preisgr. A139 (m ²)	Preisgr. A163 (m ²)	Preisgr. A181 (m ²)	
	47052H	47077H	47252H	47277H	47652H	terra <input type="checkbox"/> V3
	Preisgr. A244 (m ²)	Preisgr. A250 (m ²)	Preisgr. A139 (m ²)	Preisgr. A163 (m ²)	Preisgr. A181 (m ²)	
	47053H	47078H	47253H	47278H	47653H	indigo <input type="checkbox"/> V3
	Preisgr. A244 (m ²)	Preisgr. A250 (m ²)	Preisgr. A139 (m ²)	Preisgr. A163 (m ²)	Preisgr. A181 (m ²)	
	47054H	47079H	47254H	47279H	47654H	black <input type="checkbox"/> V3
	Preisgr. A244 (m ²)	Preisgr. A250 (m ²)	Preisgr. A139 (m ²)	Preisgr. A163 (m ²)	Preisgr. A181 (m ²)	
			47255H	47280H	47655H	forest <input type="checkbox"/> V3
			Preisgr. A139 (m ²)	Preisgr. A163 (m ²)	Preisgr. A181 (m ²)	
			47256H	47281H	47656H	grey green <input type="checkbox"/> V3
			Preisgr. A139 (m ²)	Preisgr. A163 (m ²)	Preisgr. A181 (m ²)	
			47257H	47282H	47657H	grey <input type="checkbox"/> V3
			Preisgr. A139 (m ²)	Preisgr. A163 (m ²)	Preisgr. A181 (m ²)	
			47258H	47283H	47658H	aqua <input type="checkbox"/> V3
			Preisgr. A139 (m ²)	Preisgr. A163 (m ²)	Preisgr. A181 (m ²)	
			47259H	47284H	47659H	ocean blue <input type="checkbox"/> V3
			Preisgr. A139 (m ²)	Preisgr. A163 (m ²)	Preisgr. A181 (m ²)	







KerAion-OP-Spezialglasuren

Zur Wandbekleidung von Räumen, in denen mit Lasern gearbeitet wird, z. B. OP-Säle. Die Forderung nach diffus reflektierenden Oberflächen wird hervorragend erfüllt: Auftreffende Laserstrahlen werden „zerlegt“ und unkontrollierte Reflektion somit vermieden. Das Gutachten des Laser-Medizin-Zentrums Berlin bestätigt, dass folgende im medizinischen Bereich übliche Lasertypen abgedeckt werden:

- Argon – typischer sichtbarer Laser
 - Nd:YAG – typischer Laser im nahen Infrarotbereich
 - Excimer – typischer UV-Laser
 - CO₂ – typischer Laser im mittleren Infrarotbereich
- Spezifischer Vorteil im Format 60 x 60 cm: fugenarm, daher leicht zu reinigen, hygienisch. Perfekte Ergänzung für den Boden: elektrostatisch ableitende Platte ELA 10.6 (siehe Seite 189), ebenfalls im Format 60 x 60 cm.



blau



grün



grau



hellgrau

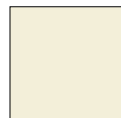

beige



weiß



Boden-/Wandplatten 60 x 60 cm, eben

Folgende Serie ist ebenfalls geeignet:

- matte Glasuren der Serien Plural (siehe Seite 338 ff.)

Im Kapitel Technische Informationen
finden Sie folgende zusätzliche
Erläuterungen zu dieser Uni-Serie:

- NCS Natural Color System
- RAL-Farbskalen
- Hellbezugswerte

Boden-/
 Wandplatten

60 x 60 cm¹

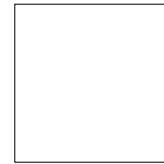

						B600HK		Formatnummer
						60 x 60 / 24 x 24		Nennmaß - cm/in
						597 x 597 x 8 mm		Herstellmaß
						eben, seidenmatt		Oberfläche
						2,780		m ² - Stück
						18,014		m ² - kg
						4		Paket - Stück
						1,439		Paket - m ²
						25,920		Paket - kg
						43,165		Palette - m ²
						777,600		Palette - kg
						Alb		Produktnorm
						2203-B600HK	4	
						Preisgr. A256 (m ²)		weiß <input type="checkbox"/> VO
						2204-B600HK	4	
						Preisgr. A256 (m ²)		beige <input type="checkbox"/> VO
						2205-B600HK	4	
						Preisgr. A256 (m ²)		hellgrau <input type="checkbox"/> VO
						2206-B600HK	3	
						Preisgr. A256 (m ²)		grau <input type="checkbox"/> VO
						2207-B600HK	3	
						Preisgr. A256 (m ²)		grün <input type="checkbox"/> VO
						2208-B600HK	4	
						Preisgr. A256 (m ²)		blau <input type="checkbox"/> VO

Die Platten der Serie KerAion-OP-Spezialglasuren sind auch in anderen Formaten
 (bis zur maximalen Kantenlänge von 120 cm) und Glasuren erhältlich.
 Bitte richten Sie bei Bedarf eine Anfrage an Ihren Kundenbetreuer.



Die geringe Fugenbreite, das Großformat und die Oberflächenveredelung Hytect
 unterstützen wirkungsvoll die leichte Reinigung und einen hohen Hygienestandard.





Fliesen für Lebensräume

Fliesen für Lebensräume – privates Wohnen, Gastronomie & Hotellerie oder öffentliche Gebäude in denen das Wohlfühlen im Vordergrund steht. Räume in denen man sich gerne aufhält. Like ist eine Fliesenkollektion, die dafür gemacht ist, im Zusammenspiel mit anderen Materialien ein perfektes Ganzes zu ergeben. Die Optik ist dezent lebendig – feine Unregelmäßigkeiten geben den Fliesen ihren unverwechselbaren Charakter und bringen jede der 5 Farben perfekt zur Geltung. Ob Mosaik oder Großformat, die Serie Like entfaltet immer ihren vollen Charme – sowohl im Raum als auch auf der Terrasse.

Rendering



R10/A+B



graphite



ash grey



cement



warm grey



off white



Bodenfliese 30 x 60 cm, strukturiert, R10/A+B



Bodenfliese 60 x 60 cm, strukturiert, R10/A+B



Bodenfliese 80 x 80 cm, strukturiert, R10/A+B



Bodenfliese 120 x 120 cm, strukturiert, R10/A+B



Treppenfiese 30 x 60 cm (rilliert), strukturiert, R10/A+B



Sockel, gerundet 7 x 60 cm, strukturiert



R10/A+B



Mosaik 5 x 5 cm

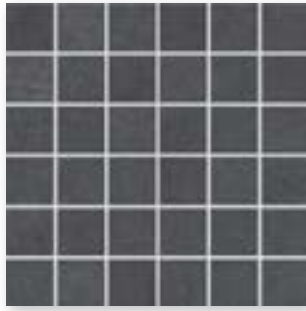

Mosaik 30 x 30 cm
graphite, strukturiert, R10/A+B

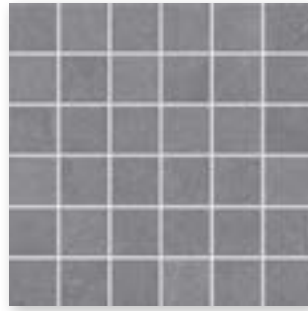

Mosaik 30 x 30 cm
ash grey, strukturiert, R10/A+B



Mosaik 30 x 30 cm
cement, strukturiert, R10/A+B



Mosaik 30 x 30 cm
warm grey, strukturiert, R10/A+B



Mosaik 30 x 30 cm
off white, strukturiert, R10/A+B

Mosaik: Verklebung rückseitig auf Glasfasernetz,
Bogen: 297 x 297 mm.

Dekorationselemente



Bordüre Tweed 30 x 44,5 cm
graphite, strukturiert, R10/A+B



Bordüre Tweed 30 x 44,5 cm
ash grey, strukturiert, R10/A+B



Bordüre Tweed 30 x 44,5 cm
cement, strukturiert, R10/A+B

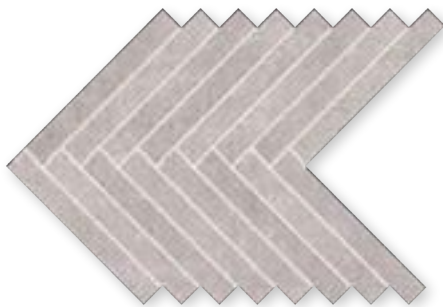

Bordüre Tweed 30 x 44,5 cm
warm grey, strukturiert, R10/A+B



Bordüre Tweed 30 x 44,5 cm
off white, strukturiert, R10/A+B

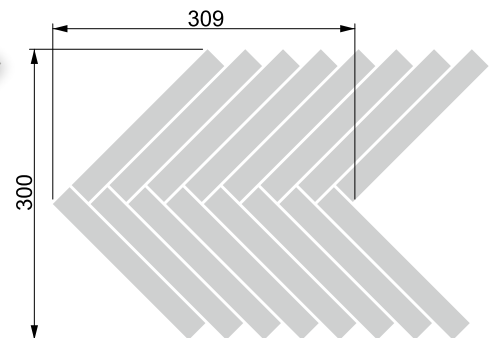

Bordüre: Verklebung rückseitig auf Glasfasernetz,
Bogen: 297 x 442 mm.



graphite



ash grey



cement



warm grey



off white



Terrassenplatte 60 x 60 cm, strukturiert, R11/B



graphite



cement

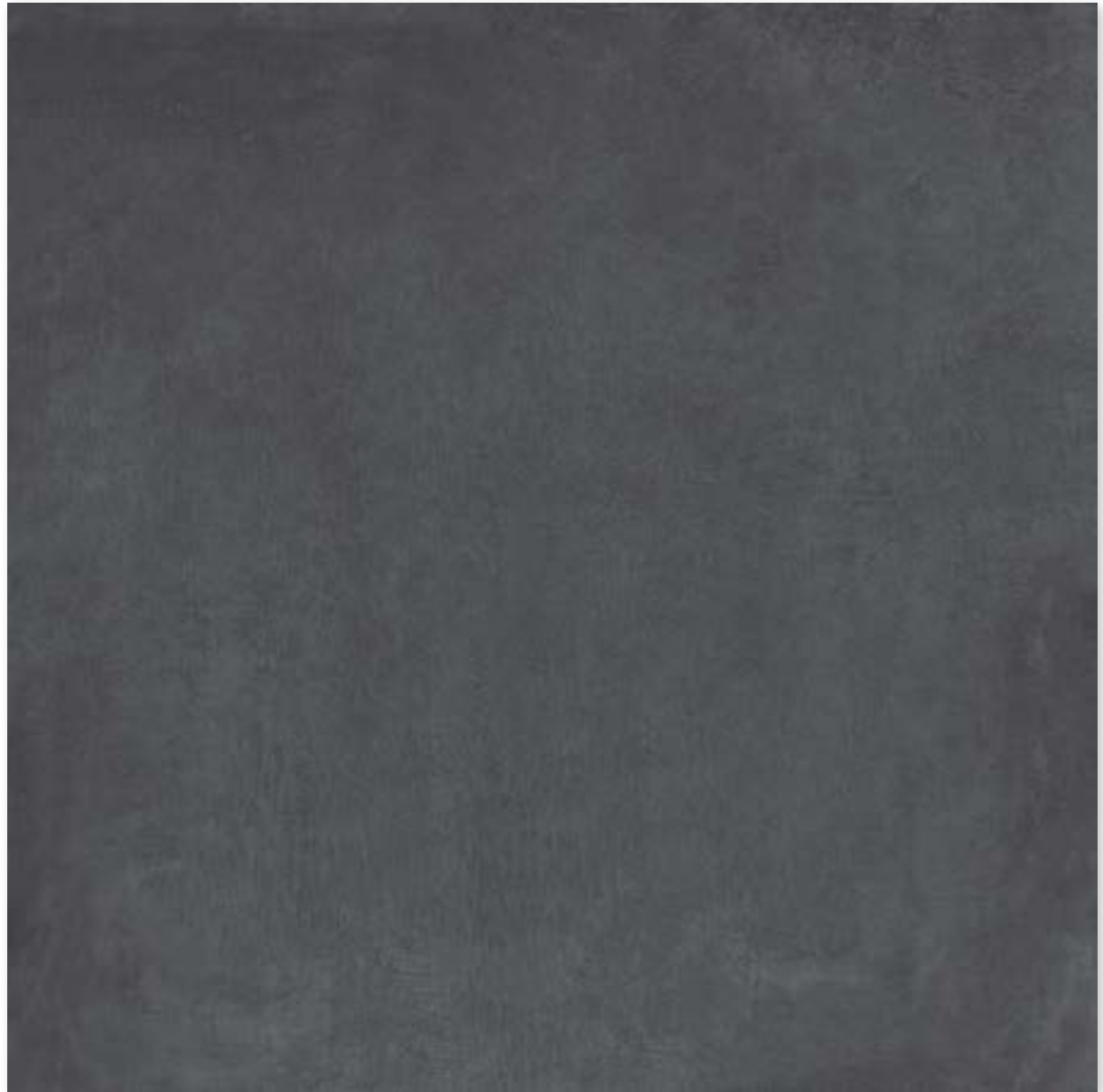

Terrassenplatte 120 x 120 cm, strukturiert, R11/B

Mosaik^{1/3}

5 x 5 cm



Dekorations-
elemente^{2/3}

30 x 44,5 cm

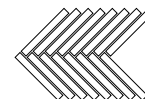

protected

Bogen: 297 x 297 mm

Bordüre

Bogen: 297 x 442 mm

					5 x 5 / 2 x 2	30 x 44,5 / 12 x 18			Nennmaß - cm/in
					47 x 47 x 9 mm	297 x 442 x 9 mm			Herstellmaß
					strukturiert, matt	strukturiert, matt			Oberfläche
					11,111/m ²	3,236/m			m ² /m - Stück
					19,833/m ²	5,191/m			m ² /m - kg
					12	2			Paket - Stück
					1,080 m ²	0,618 m			Paket - m ² /m
					21,420	3,208			Paket - kg
					32,400				Palette - m ²
					642,600				Palette - kg
					Bla	Bla			Produktnorm
					R10/A+B	R10/A+B			Trittsicherheit
					2	2			Belastung
					430640	430635			graphite <input type="checkbox"/> V2
					Preisgr. W303 (m ²)	Preisgr. W515 (St.)			ash grey <input type="checkbox"/> V2
					430641	430636			cement <input type="checkbox"/> V2
					Preisgr. W303 (m ²)	Preisgr. W515 (St.)			warm grey <input type="checkbox"/> V2
					430642	430637			off white <input type="checkbox"/> V2
					Preisgr. W303 (m ²)	Preisgr. W515 (St.)			
					430643	430638			
					Preisgr. W303 (m ²)	Preisgr. W515 (St.)			
					430644	430639			
					Preisgr. W303 (m ²)	Preisgr. W515 (St.)			



¹ Abgabe der Dekorationselemente nur in vollen Kartons.

² Verklebung rückseitig auf Glasfasernetz



Bodenfliesen¹

30 x 60 cm



60 x 60 cm

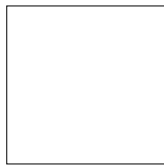



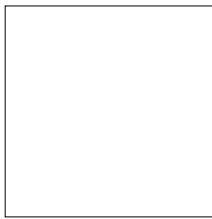

80 x 80 cm²

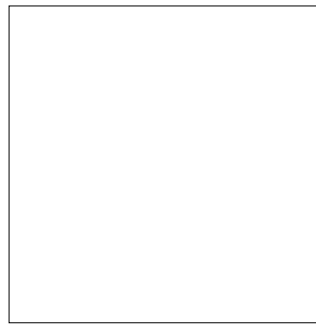

120 x 120 cm^{2/3}



protected

Nennmaß - cm/in	30 x 60 / 12 x 24	60 x 60 / 24 x 24	80 x 80 / 32 x 32		120 x 120 / 48 x 48		
Herstellmaß	297 x 596 x 9 mm	596 x 596 x 9 mm	795 x 795 x 9 mm		1194 x 1194 x 9 mm		
Oberfläche	strukturiert, matt	strukturiert, matt	strukturiert, matt		strukturiert, matt		
m ² - Stück	5,556	2,778	1,563		0,694		
m ² - kg	19,841	19,288	21,381		21,098		
Paket - Stück	7	3	2		2		
Paket - m ²	1,260	1,080	1,280		2,882		
Paket - kg	24,997	20,829	27,360		60,800		
Palette - m ²	50,396	43,197	61,420		57,637		
Palette - kg	999,880	833,160	1.313,280		1.216,000		
Produktnorm	Bla	Bla	Bla		Bla		
Trittsicherheit	R10/A+B	R10/A+B	R10/A+B		R10/A+B		
Belastung	2	2	2		2		
graphite 	430645 Preisgr. W102 (m ²)	430650 Preisgr. W117 (m ²)	430655 Preisgr. W138 (m ²)		430660 Preisgr. W177 (m ²)		
ash grey 	430646 Preisgr. W102 (m ²)	430651 Preisgr. W117 (m ²)	430656 Preisgr. W138 (m ²)		430661 Preisgr. W177 (m ²)		
cement 	430647 Preisgr. W102 (m ²)	430652 Preisgr. W117 (m ²)	430657 Preisgr. W138 (m ²)		430662 Preisgr. W177 (m ²)		
warm grey 	430648 Preisgr. W102 (m ²)	430653 Preisgr. W117 (m ²)	430658 Preisgr. W138 (m ²)		430663 Preisgr. W177 (m ²)		
off white 	430649 Preisgr. W102 (m ²)	430654 Preisgr. W117 (m ²)	430659 Preisgr. W138 (m ²)		430664 Preisgr. W177 (m ²)		



¹ ² Achtung: Sonderpalette. Keine Rücknahme, kein Umtausch.
³ Hohes Gewicht! Karton bitte nur zu Zweit transportieren.

Treppenfliese¹ Sockel, gerundet¹

30 x 60 cm²

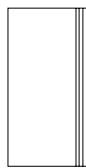

7 x 60 cm



Terrassenplatten¹

60 x 60 cm³



120 x 120 cm^{3/4}



protected

	30 x 60 / 12 x 24	7 x 60 / 2 13/16 x 24	60 x 60 / 24 x 24	120 x 120 / 48 x 48		Nennmaß - cm/in
	297 x 596 x 9 mm	70 x 596 x 9 mm	596 x 596 x 20 mm	1198 x 1198 x 20 mm		Herstellmaß
	strukturiert, matt	strukturiert, matt	strukturiert, matt	strukturiert, matt		Oberfläche
	1,667/m	1,667/m	2,778/m ²	0,700/m ²		m ² /m - Stück
	5,972/m	1,357/m	47,226/m ²	46,567/m ²		m ² /m - kg
	7	22	2	1		Paket - Stück
	4,199 m	13,197 m	0,720 m ²	1,440 m ²		Paket - m ² /m
	25,081	17,908	34,000	67,100		Paket - kg
			21,598	28,563		Palette - m ²
			1.020,000	1.342,000		Palette - kg
	Bla	Bla	Bla	Bla		Produktnorm
	R10/A+B		R11/B	R11/B		Trittsicherheit
	2		4	4		Belastung
	430672	430677	430665	430670		graphite <input type="checkbox"/> V2
	Preisgr. W473 (St.)	Preisgr. W439 (St.)	Preisgr. W177 (m ²)	Preisgr. W261 (m ²)		ash grey <input type="checkbox"/> V2
	430673	430678	430666			cement <input type="checkbox"/> V2
	Preisgr. W473 (St.)	Preisgr. W439 (St.)	Preisgr. W177 (m ²)			warm grey <input type="checkbox"/> V2
	430674	430679	430667	430671		off white <input type="checkbox"/> V2
	Preisgr. W473 (St.)	Preisgr. W439 (St.)	Preisgr. W177 (m ²)	Preisgr. W261 (m ²)		
	430675	430680	430668			
	Preisgr. W473 (St.)	Preisgr. W439 (St.)	Preisgr. W177 (m ²)			
	430676	430681	430669			
	Preisgr. W473 (St.)	Preisgr. W439 (St.)	Preisgr. W177 (m ²)			



¹ Hohes Gewicht! Karton bitte nur zu Zweit transportieren.
² Achtung: Sonderpalette. Keine Rücknahme, kein Umtausch.



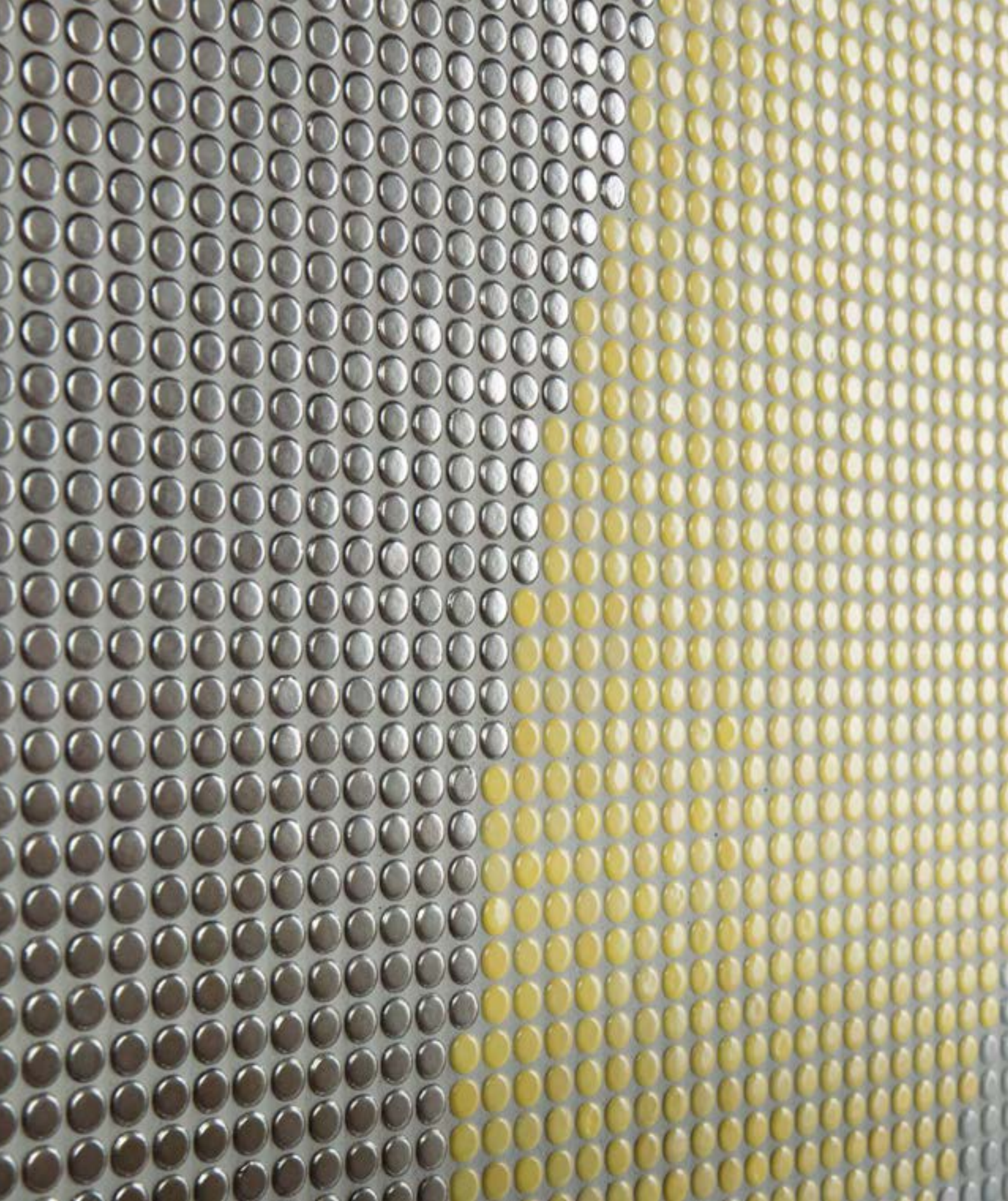



Fein und rund

Die perfekte Antwort auf den Trend zu weichen, abgerundeten Designs gibt das Mosaik Loop. Es wird in 15 fein nuancierten, hochglänzenden Farbstellungen geliefert, von denen sechs auch in matter, rutschhemmender Ausführung erhältlich sind. So wird das Einsatzspektrum auf Duschen und andere Nassbereiche erweitert. Neben dem Mosaik mit 2 cm Durchmesser steht auch eine 1 cm Variante zur Verfügung, die besonders filigran und edel wirkt. In Kontrastfarben eignet sie sich auch für Piktogramme, Buchstaben, Pfeile und QR-Codes.

Studioaufnahme

Mosaik Ø 1 cm

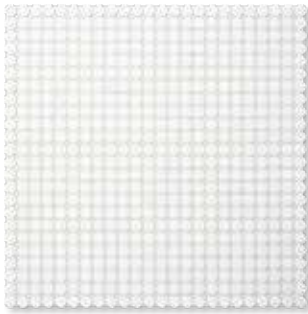

Mosaikbogen 32 x 32 cm arktisweiß glänzend, eben

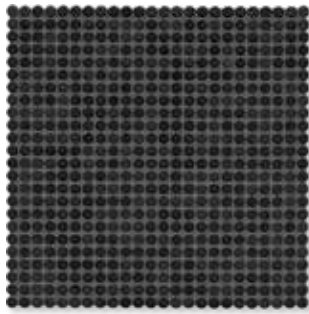

Mosaikbogen 32 x 32 cm nachtschwarz glänzend, eben



Mosaikbogen 32 x 32 cm elfenbein hell glänzend, eben



Mosaikbogen 32 x 32 cm elfenbein glänzend, eben



Mosaikbogen 32 x 32 cm diamantgrau hell glänzend, eben



Mosaikbogen 32 x 32 cm diamantgrau glänzend, eben

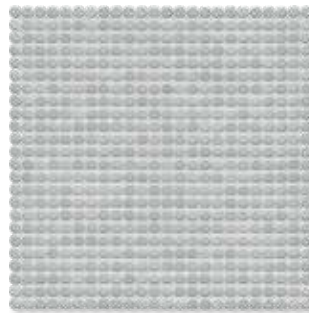

Mosaikbogen 32 x 32 cm denim glänzend, eben



Mosaikbogen 32 x 32 cm aquablau hell glänzend, eben

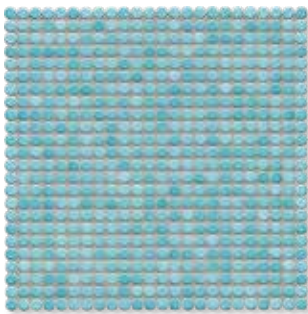

Mosaikbogen 32 x 32 cm aquablau glänzend, eben

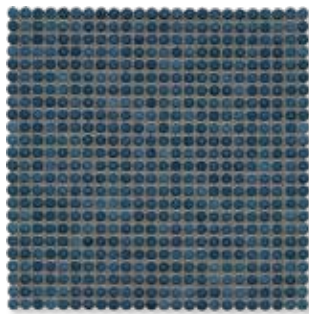

Mosaikbogen 32 x 32 cm stahlblau glänzend, eben

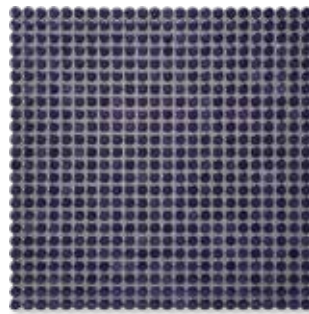

Mosaikbogen 32 x 32 cm dunkelviolet glänzend, eben

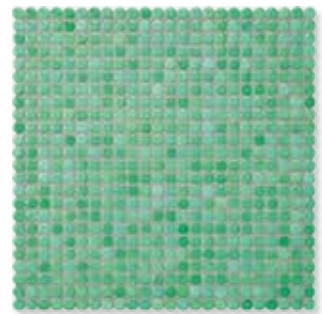

Mosaikbogen 32 x 32 cm seegrün glänzend, eben



Mosaikbogen 32 x 32 cm korallenrot glänzend, eben

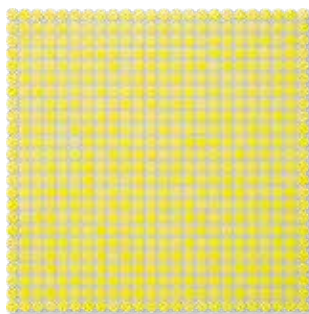

Mosaikbogen 32 x 32 cm zitronengelb glänzend, eben

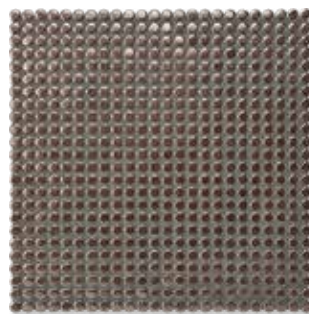

Mosaikbogen 32 x 32 cm bronze metallic, eben

Die dargestellten Produkte können auch in anderen Farben gefertigt werden. Gerne prüfen wir die Möglichkeit einer solchen Sonderproduktion im Einzelfall.



Rückseitig thermoplastisch verklebte Mosaik von Agrob Buchtal sind nicht nur im Trockenbereich, sondern auch bedenkenlos im Unterwasserbereich (z. B. Schwimmbecken/Whirlpool) sowie im dauernassbelasteten Bereich einsetzbar.

Farbverlauf Ø 1 cm

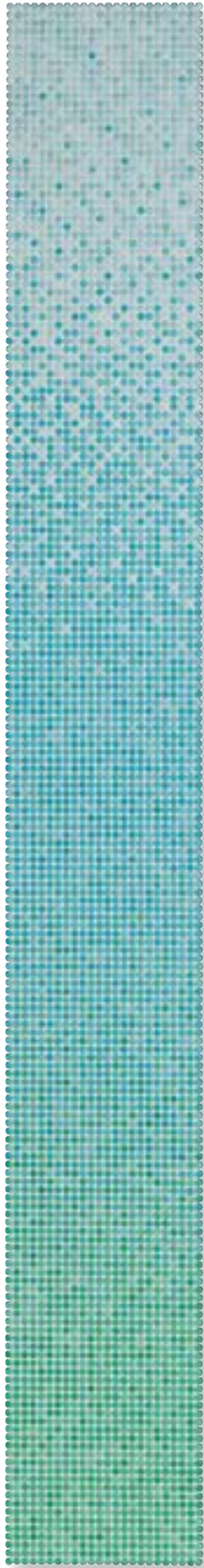

ocean glänzend

Farbverlauf Ø 2 cm



ocean glänzend

Weitere Beispiele

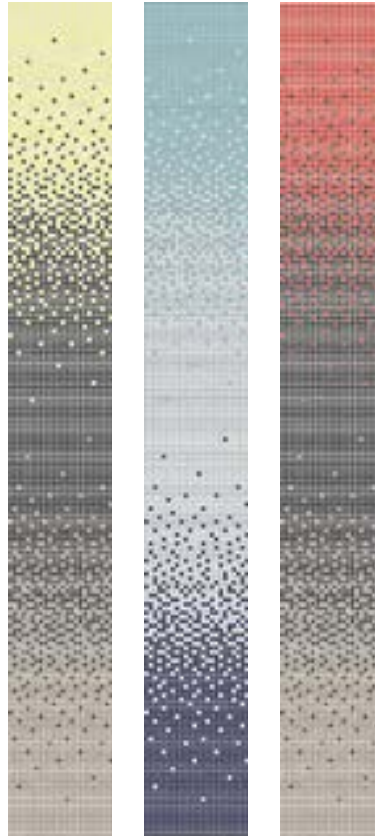

Herstellmaß ohne Außenfuge
314 x 2528 x 6,5 mm

Farben aus Loop können im Standard Farbverlauf beliebig ohne Aufpreis ausgetauscht werden. Eine individuelle Gestaltung von Farbverläufen bezüglich der Maße und Farbverhältnisse prüfen wir gerne als Sonderproduktion.

Kennen Sie schon unseren Mosaic Designer auf unserer Website www.agrob-buchtal.de? Hier haben Sie die Möglichkeit Ihre individuellen Farbverläufe, Mosaikmischungen und Bildverlegungen zu gestalten.

Mosaik Ø 2 cm



Mosaikbogen 32 x 32 cm arktisweiß glänzend, eben, Mosaikbogen 32 x 32 cm arktisweiß, eben, R10/B

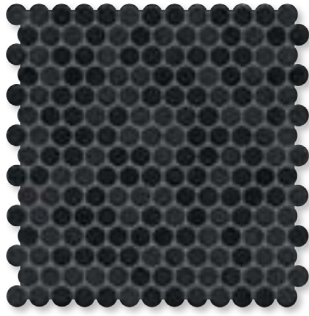

Mosaikbogen 32 x 32 cm nachtschwarz glänzend, eben, Mosaikbogen 32 x 32 cm nachtschwarz, eben, R10/B



Mosaikbogen 32 x 32 cm elfenbein glänzend, eben, Mosaikbogen 32 x 32 cm elfenbein, eben, R10/B



Mosaikbogen 32 x 32 cm elfenbein glänzend, eben

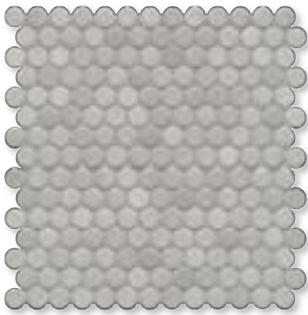

Mosaikbogen 32 x 32 cm diamantgrau glänzend, eben, Mosaikbogen 32 x 32 cm diamantgrau, eben, R10/B

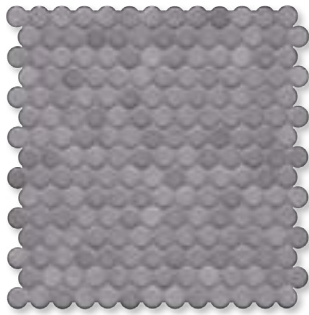

Mosaikbogen 32 x 32 cm diamantgrau glänzend, eben



Mosaikbogen 32 x 32 cm denim glänzend, eben



Mosaikbogen 32 x 32 cm aquablau hell glänzend, eben, Mosaikbogen 32 x 32 cm aquablau hell, eben, R10/B



Mosaikbogen 32 x 32 cm aquablau glänzend, eben, Mosaikbogen 32 x 32 cm aquablau, eben, R10/B

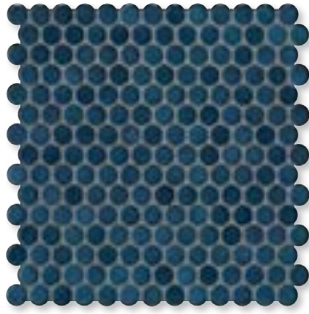

Mosaikbogen 32 x 32 cm stahlblau glänzend, eben

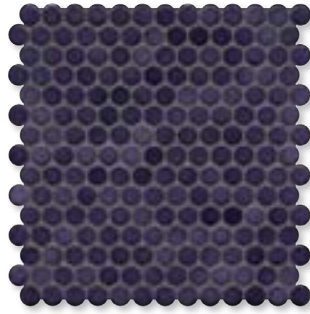

Mosaikbogen 32 x 32 cm dunkelviolet glänzend, eben



Mosaikbogen 32 x 32 cm seegrün glänzend, eben, Mosaikbogen 32 x 32 cm seegrün, eben, R10/B

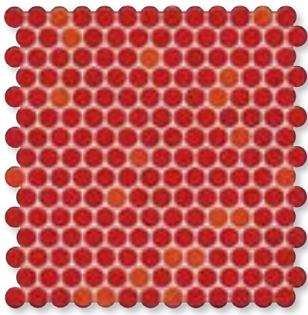

Mosaikbogen 32 x 32 cm korallenrot glänzend, eben

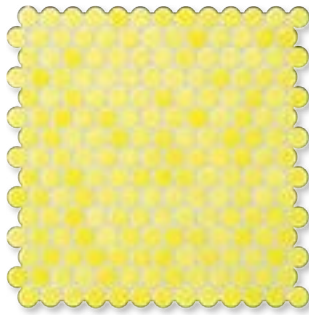

Mosaikbogen 32 x 32 cm zitronengelb glänzend, eben



Mosaikbogen 32 x 32 cm bronze metallic glänzend, eben



Rückseitig thermoplastisch verklebte Mosaik sind nicht nur im Trockenbereich, sondern auch bedenkenlos im Unterwasserbereich (z. B. Schwimmbecken/Whirlpool) sowie im dauernassbelasteten Bereich einsetzbar.

Mosaik

Farbverlauf

Ø 1 cm

Ø 2 cm

Ø 1 cm^{1/3}

Ø 2 cm^{2/3}

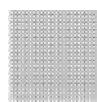

		Bogen: 316 x 316 mm	Bogen: 326 x 316 mm	Bogen: 316 x 316 mm	Bogen: 326 x 316 mm	Beanspruchungsgruppe
		Ø 1 / 3/8	Ø 2 / 6/8	Ø 1 / Ø 3/8	Ø 2 / 6/8	
		Ø 12 x 6,5 mm	Ø 22,3 x 6,5 mm	Ø 12 x 6,5 mm	Ø 22,3 x 6,5 mm	Nennmaß - cm/in
		eben, glänzend	eben, glänzend	eben, glänzend	eben, glänzend	Herstellmaß
		10 Bögen	10 Bögen			Oberfläche
		9,720	11,600			m ² - Stück
		10 Bögen	10 Bögen	8 Bögen	8 Bögen	m ² - kg
		1,000	1,000	0,800	0,800	Paket - Stück
		9,720	11,600	7,776	8,872	Paket - m ²
		24,000	48,000			Paket - kg
		233,280	556,800			Palette - m ²
		Blb	Blb	Blb	Blb	Palette - kg
		40000H	40020H			Produktnorm
		Preisgr. A382 (m ²)	Preisgr. A304 (m ²)			3 arktisweiß
		40001H	40021H			glänzend <input type="checkbox"/> V2
		Preisgr. A382 (m ²)	Preisgr. A304 (m ²)			2 nachtschwarz
		40002H	40022H			glänzend <input type="checkbox"/> V2
		Preisgr. A382 (m ²)	Preisgr. A304 (m ²)			3 elfenbein hell
		40003H	40023H			glänzend <input type="checkbox"/> V2
		Preisgr. A382 (m ²)	Preisgr. A304 (m ²)			3 elfenbein
		40004H	40024H			glänzend <input type="checkbox"/> V2
		Preisgr. A382 (m ²)	Preisgr. A304 (m ²)			3 diamantgrau hell
		40005H	40025H			glänzend <input type="checkbox"/> V2
		Preisgr. A382 (m ²)	Preisgr. A304 (m ²)			2 diamantgrau
		40006H	40026H			glänzend <input type="checkbox"/> V2
		Preisgr. A382 (m ²)	Preisgr. A304 (m ²)			3 denim
		40007H	40027H			glänzend <input type="checkbox"/> V2
		Preisgr. A382 (m ²)	Preisgr. A304 (m ²)			3 aquablau hell
		40008H	40028H			glänzend <input type="checkbox"/> V2
		Preisgr. A382 (m ²)	Preisgr. A304 (m ²)			2 aquablau
		40009H	40029H			glänzend <input type="checkbox"/> V2
		Preisgr. A382 (m ²)	Preisgr. A304 (m ²)			2 stahlblau
		40010H	40030H			glänzend <input type="checkbox"/> V2
		Preisgr. A382 (m ²)	Preisgr. A304 (m ²)			2 dunkelviolet
		40011H	40031H			glänzend <input type="checkbox"/> V2
		Preisgr. A382 (m ²)	Preisgr. A304 (m ²)			3 seegrün
		40012H	40032H			glänzend <input type="checkbox"/> V2
		Preisgr. A382 (m ²)	Preisgr. A304 (m ²)			2 korallenrot
		40013H	40033H			glänzend <input type="checkbox"/> V2
		Preisgr. A382 (m ²)	Preisgr. A304 (m ²)			3 zitronengelb
		40014^{4/5}	40034^{4/5}			glänzend <input type="checkbox"/> V2
		Preisgr. A385 (m ²)	Preisgr. A346 (m ²)			1 bronze-metallic
				40056H	40057H	2 ocean
				Preisgr. A791 (St.)	Preisgr. A750 (St.)	glänzend <input type="checkbox"/> V2

¹ Herstellmaß ohne Außenfuge: 316 x 2528 x 6,5 mm

² Herstellmaß ohne Außenfuge: 326 x 2528 x 6,5 mm

³ Preisangabe bezieht sich auf den Farbverlauf = 8 Bögen

⁴ Nicht oder nur bedingt säure- und laugenbeständig.

⁵ ohne Hytect

Farbverläufe können individuell gestaltet werden. Gerne prüfen wir die Möglichkeit einer solchen Sonderproduktion im Einzelfall.

Kennen Sie schon unseren Mosaic Designer auf unserer Website www.agrob-buchtal.de?

Hier haben Sie die Möglichkeit Ihre individuellen Farbverläufe, Mosaikmischungen und Bildverlegungen zu gestalten.



Mosaik

Ø 2 cm



Bogen: 326 x 316 mm

Nennmaß - cm/in		Ø 2 / 6/8					
Herstellmaß		Ø 22,3 x 6,5 mm					
Oberfläche		eben, matt					
m ² - Stück	Beanspruchungsgruppe	10 Bögen					
m ² - kg		11,600					
Paket - Stück		10 Bögen					
Paket - m ²		1,000					
Paket - kg		11,600					
Palette - m ²		48,000					
Palette - kg		556,800					
Produktnorm			Blb				
Trittsicherheit			R10/B				
			4 40040H				
arktischweiß <input type="checkbox"/>	<input type="checkbox"/>	Preisgr. A313 (m ²)					
		2 40041H					
nachtschwarz <input type="checkbox"/>	<input type="checkbox"/>	Preisgr. A313 (m ²)					
		4 40042H					
elfenbein hell <input type="checkbox"/>	<input type="checkbox"/>	Preisgr. A313 (m ²)					
		4 40044H					
diamantgrau hell <input type="checkbox"/>	<input type="checkbox"/>	Preisgr. A313 (m ²)					
		4 40047H					
aquablau hell <input type="checkbox"/>	<input type="checkbox"/>	Preisgr. A313 (m ²)					
		3 40048H					
aquablau <input type="checkbox"/>	<input type="checkbox"/>	Preisgr. A313 (m ²)					
		3 40071H					
seegrün <input type="checkbox"/>	<input type="checkbox"/>	Preisgr. A313 (m ²)					



Die dargestellten Produkte können auch in anderen Farben gefertigt werden. Gerne prüfen wir die Möglichkeit einer solchen Sonderproduktion im Einzelfall.

Lintharena, Näfels, Schweiz / Architekt: K & L Architekten AG, St. Gallen, Schweiz
Serie: Loop Sondermischung / Foto: Kim Britt Photography







Natürliche Spielräume in der Gestaltung

Einzigartig in ihrer keramischen Komposition sowie mit Farbnuancen zwischen Anthrazit und Weiß macht sich die Lounge in jedem Raum hervorragend. Das Dekor Stone mit dezenter Marmor- und Steinoptik ist das Highlight jeder Raumgestaltung – auf großen oder kleinen Flächen. Die farbenfrohe Dekoration Garden entführt uns in die exotischen Gärten dieser Welt. Alle Fliesen sind Hytect-veredelt und besonders pflegeleicht.

Rendering

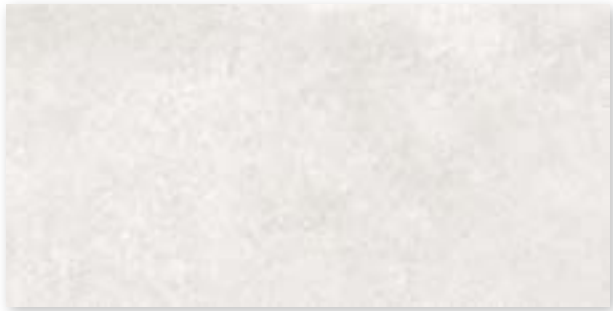

Wandfliese 30 x 60 cm, light taupe, strukturiert



Wandfliese 30 x 60 cm, grey white, strukturiert



Wandfliese 30 x 90 cm, light taupe, strukturiert

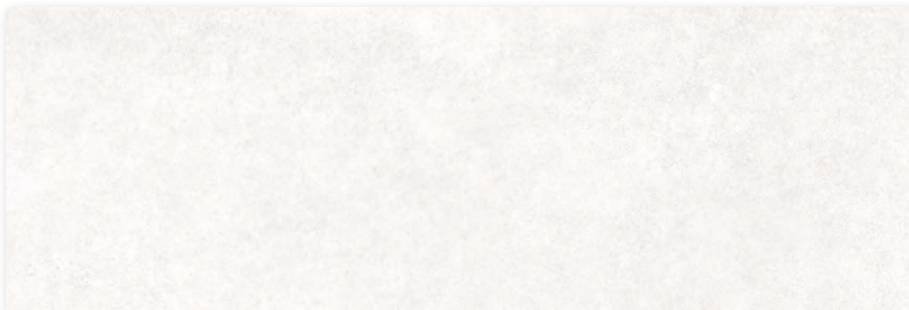

Wandfliese 30 x 90 cm, grey white, strukturiert

Dekorationselemente



Dekorfliese Garden 30 x 60 cm, green mix, strukturiert



Dekorfliese Stone 30 x 90 cm, grey mix, strukturiert

Bei der von Ihnen ausgewählten Dekoration handelt es sich um ein hochwertiges Produkt aus Steingut glasiert. Die Dekoration besteht aus unterschiedlichen Einzelbildern. Die Anschlüsse der Einzelbilder sind bewusst frei gestaltet und verbinden sich somit nicht in der fortlaufenden Verlegung. Die Motivzusammenstellung im Karton kann produktionsbedingt variieren.



R10/A+B



dark taupe



light sand



warm grey



dark anthracite



Bodenfliese 30 x 60 cm, strukturiert, R10/A+B



Bodenfliese 60 x 60 cm, strukturiert, R10/A+B

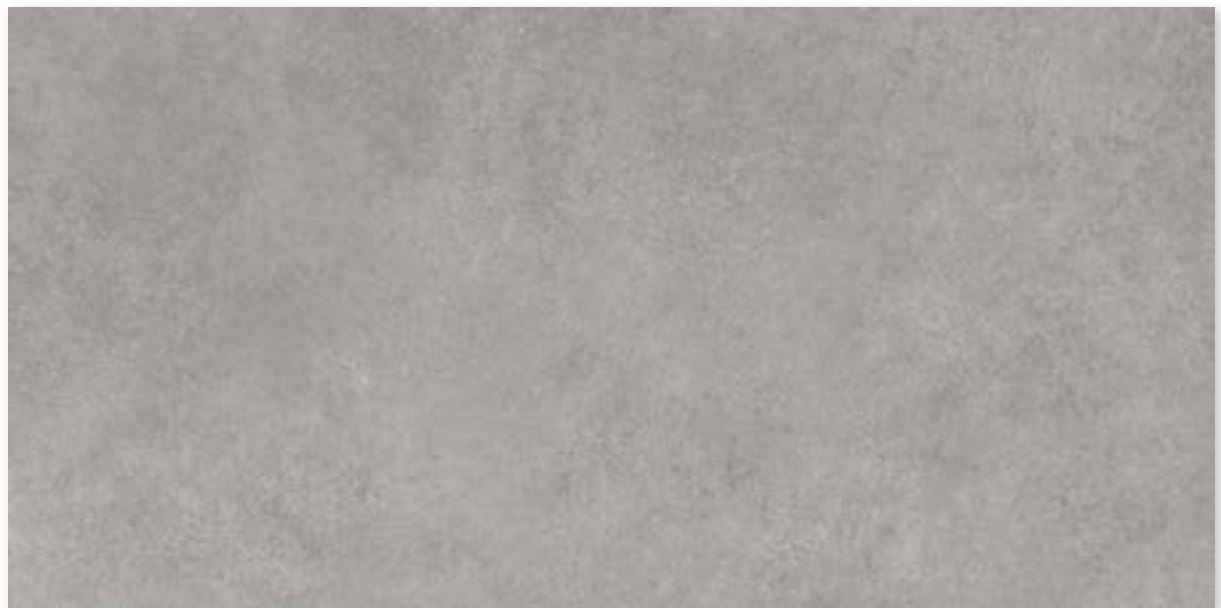

Bodenfliese 60 x 120 cm, strukturiert, R10/A+B

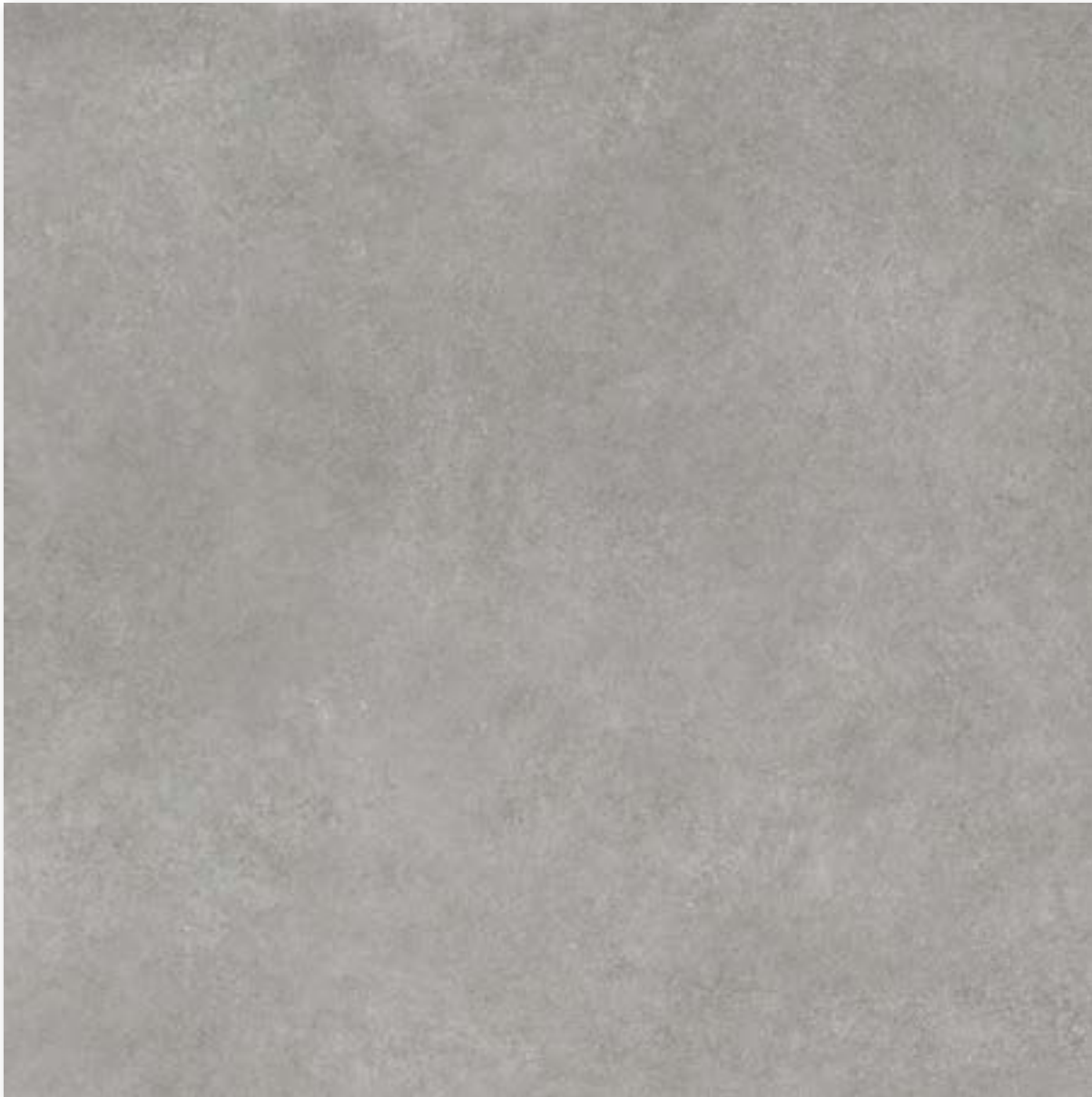

Bodenfliese 120 x 120 cm, strukturiert, R10/A+B



Sockel, geschnitten 7 x 60 cm, strukturiert

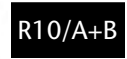

Mosaik 5 x 5 cm

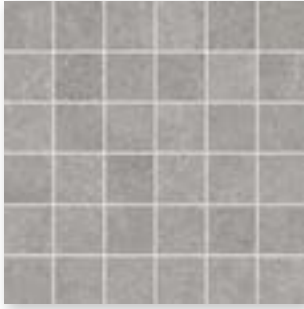

Mosaik 30 x 30 cm
dark taupe, strukturiert, R10/A+B



Mosaik 30 x 30 cm
light sand, strukturiert, R10/A+B



Mosaik 30 x 30 cm
warm grey, strukturiert, R10/A+B

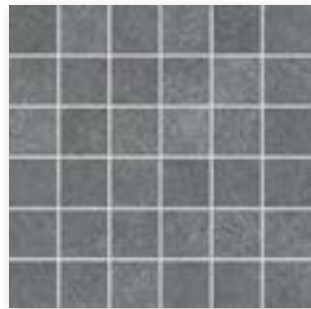

Mosaik 30 x 30 cm
dark anthracite, strukturiert, R10/A+B

Mosaik: Verklebung rückseitig auf Glasfasernetz,
Bogen: 297 x 297 mm.

Wandfliesen

Dekorationselemente²

30 x 60 cm

30 x 90 cm¹

30 x 60 cm

30 x 90 cm¹

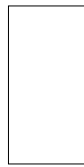

		<i>Dekorfliese Garden</i>		<i>Dekorfliese Stone</i>		
		30 x 60 / 12 x 24	30 x 90 / 12 x 36	30 x 60 / 12 x 24	30 x 90 / 6 x 36	Nennmaß - cm/in
		297 x 597 x 6 mm	297 x 897 x 6 mm	297 x 597 x 6 mm	297 x 897 x 6 mm	Herstellmaß
		strukturiert, seidenmatt	strukturiert, seidenmatt	strukturiert, steinmatt	strukturiert, steinmatt	Oberfläche
		5,556	3,704	5,556	3,704	m ² - Stück
		10,279	10,400	10,279	10,400	m ² - kg
		13	8	13	8	Paket - Stück
		2,340	2,160	2,340	2,160	Paket - m ²
		24,050	22,464	24,050	22,464	Paket - kg
		112,311	51,836	112,311	51,836	Palette - m ²
		1.154,400	539,136	1.154,400	539,136	Palette - kg
		BIII	BIII	BIII	BIII	Produktnorm
		203392H	323395H			light taupe <input type="checkbox"/> V2
		Preisgr. C77 (m ²)	Preisgr. C143 (m ²)			grey white <input type="checkbox"/> V2
		203393H	323396H			green mix <input type="checkbox"/> V4
		Preisgr. C77 (m ²)	Preisgr. C143 (m ²)	203394H		grey mix <input type="checkbox"/> V4
				Preisgr. C89 (m ²)		
					323397H	
					Preisgr. C149 (m ²)	



² Abgabe der Dekorationselemente ausschließlich in vollen Kartons.

Mosaik^{1/5}

Bodenfliesen¹

Sockel,
geschnitten¹

5 x 5 cm



30 x 60 cm

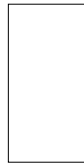

60 x 60 cm

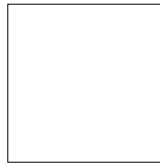

60 x 120 cm^{3/4}

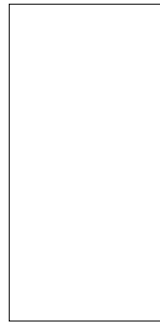

120 x 120 cm^{2/3/4}

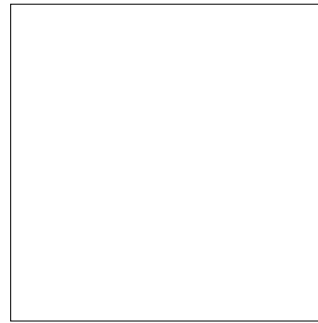

7 x 60 cm



Bogen: 297 x 297 mm

Nennmaß - cm/in	5 x 5 / 2 x 2	30 x 60 / 12 x 24	60 x 60 / 24 x 24	60 x 120 / 24 x 48	120 x 120 / 48 x 48	7 x 60 / 2 13/16 x 24
Herstellmaß	47 x 47 x 6 mm	297 x 597 x 6 mm	597 x 597 x 6 mm	597 x 1197 x 6 mm	1198 x 1198 x 6 mm	70 x 597 x 6 mm
Oberfläche	strukturiert, matt	strukturiert, matt	strukturiert, matt	strukturiert, matt	strukturiert, matt	strukturiert, matt
m ² /m - Stück	11,111/m ²	5,556/m ²	2,778/m ²	1,388/m ²	0,694/m ²	1,667/m
m ² /m - kg	11,488/m ²	13,273/m ²	13,581/m ²	14,088/m ²	14,100/m ²	0,938/m
Paket - Stück	11 Bögen	10	5	3	2	38
Paket - m ² /m	0,990 m ²	1,800 m ²	1,800 m ²	2,161 m ²	2,882 m ²	22,795 m
Paket - kg	11,374	23,890	24,445	30,450	40,600	21,394
Palette - m ²	35,640	71,994	64,795	75,648	69,124	
Palette - kg	409,464	955,600	880,020	1.065,750	974,400	
Produktnorm	Bla	Bla	Bla	Bla	Bla	Bla
Trittsicherheit	R10/A+B	R10/A+B	R10/A+B	R10/A+B	R10/A+B	
Belastung	1	1	1	1	1	1
dark taupe	431328H Preisgr. C308 (m ²)	431332H Preisgr. C98 (m ²)	431336H Preisgr. C107 (m ²)	431340H Preisgr. C137 (m ²)	431344 Preisgr. C188 (m ²)	431348H Preisgr. C437 (St.)
light sand	431329H Preisgr. C308 (m ²)	431333H Preisgr. C98 (m ²)	431337H Preisgr. C107 (m ²)	431341H Preisgr. C137 (m ²)	431345 Preisgr. C188 (m ²)	431349H Preisgr. C437 (St.)
warm grey	431330H Preisgr. C308 (m ²)	431334H Preisgr. C98 (m ²)	431338H Preisgr. C107 (m ²)	431342H Preisgr. C137 (m ²)	431346 Preisgr. C188 (m ²)	431350H Preisgr. C437 (St.)
dark anthracite	431331H Preisgr. C308 (m ²)	431335H Preisgr. C98 (m ²)	431339H Preisgr. C107 (m ²)	431343H Preisgr. C137 (m ²)	431347 Preisgr. C188 (m ²)	431351H Preisgr. C437 (St.)



- ¹ ohne Hytect-Veredelung; mit Protecta-Vergütung
- ³ Hohes Gewicht! Karton bitte nur zu Zweit transportieren.
- ⁴ Achtung: Sonderpalette. Keine Rücknahme, kein Umtausch.
- ⁵ Verklebung rückseitig auf auf Glasfasernetz

Rendering







Natürlich und lässig

Der gewollte Used Look berücksichtigt natürliche Gebrauchsspuren und zarte Verfärbungen. Die Wandfliese ist eine Collage aus streifigen Maserungen und freien Pinselfstrichen. Durch Überlagerungen und Überkreuzungen entsteht eine richtungsfreie Optik die besonders in der Farbstellung weiß-bunt ihren künstlerischen Charakter entfaltet.

Rendering / Architekt: STELLWERK architekten, Dresden, Deutschland



Wandfliese 30 x 60 cm, naturweiß, eben



Wandfliese 30 x 60 cm, weiß-bunt, eben

Dekorationselemente



Bordüre Canvas 4 x 60 cm, grau-schwarz, strukturiert

Wandfliese³

Dekorations-
elemente^{1/2/4/5}

30 x 60 cm

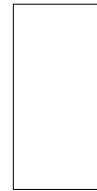

4 x 60 cm



					<i>Bordüre Canvas</i>			
				30 x 60 / 12 x 24	4 x 60 / 1 5/8 x 24	Nennmaß - cm/in		
				297 x 597 x 9 mm	37 x 597 x 10,5 mm	Herstellmaß		
				eben, seidenmatt	strukturiert, matt	Oberfläche		
				5,556/m ²	1,667/m	m ² /m - Stück		
				14,946/m ²	0,910/m	m ² /m - kg		
				9	3	Paket - Stück		
				1,620 m ²	1,800 m	Paket - m ² /m		
				24,210	1,638	Paket - kg		
				77,754		Palette - m ²		
				1.162,080		Palette - kg		
				BIII	Bla	Produktnorm		
				282901				
				Preisgr. C89 (m ²)		naturweiß	V2	
				282902				
				Preisgr. C89 (m ²)		weiß-bunt	V4	
					282903			
					Preisgr. C437 (St.)	grau-schwarz	V3	



- ³ nicht frostsicher
- ⁴ Nur für die Verlegung an der Wand im Innenbereich geeignet.
- ⁵ Abgabe der Dekorationselemente ausschließlich in vollen Kartons.





Herr der Gezeiten – Zeit für Inspiration

Mando verleiht einem Bad ein helles und luftiges, an Sand, Treibgut und Wind erinnerndes Ambiente. Matt- oder glänzend-weiße Wandfliesen in 35 x 100 cm schaffen einen klaren Rahmen für das Volldekor Spirit im gleichen Format – in grau-blau matt oder creme-cotto matt. Ein weiteres optisches Highlight in korrespondierenden Farben: das Riegel-Dekor Cabana mit Holz-Mix-Optik in 8,45 x 33 cm. In diese Gesamtidee von authentischer Natürlichkeit fügt sich die Vintage-Holz-Serie Walden als Boden harmonisch ein. Alle Fliesen von Mando sind aufgrund ihrer Hytect-Oberfläche reinigungsfreundlich.

Studioaufnahme / Architekt: STELLWERK architekten, Dresden, Deutschland / Foto: Jochen Stüber



Wandfliese 35 x 100 cm, weiß

Dekorationselemente



Dekorfliese Cabana 8,45 x 33 cm, braun-mix, eben

Die Riegel Cabana variieren bewusst in der Farbigkeit. Bitte gemischt aus mehreren Kartons verlegen, damit sich ein gleichmäßiges Bild ergibt.

Dekorationselemente



Dekorfliese Spirit 35 x 100 cm, grau-blau, eben

Dekorationselemente



Dekorfliese Spirit 35 x 100 cm, creme-cotto, eben

Wandfliese¹ Dekorationselemente³

35 x 100 cm

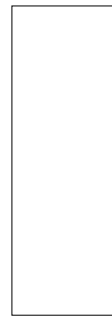

8,45 x 33 cm²



35 x 100 cm^{1/4}

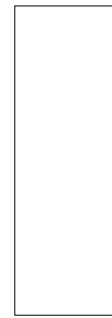

				Dekorfliese Cabana	Dekorfliese Spirit		
				35 x 100 / 14 x 40	8,45 x 33 / 313/32 x 1313/64	35 x 100 / 14 x 40	Nennmaß - cm/in
				347 x 997 x 6 mm	84,5 x 330 x 6 mm	347 x 997 x 6 mm	Herstellmaß
				eben	eben, seidenmatt	eben, seidenmatt	Oberfläche
				2,857/m ²	3,030/m	1,000/m	m ² /m - Stück
				10,108/m ²	0,878/m	3,538/m	m ² /m - kg
				5	18	3	Paket - Stück
				1,750 m ²	5,940 m	3,000 m	Paket - m ² /m
				17,690	5,220	10,614	Paket - kg
				70,004			Palette - m ²
				707,600			Palette - kg
				BIII	BIII	BIII	Produktnorm
				363347H			weiß glänzend <input type="checkbox"/> V3
				Preisgr. W132 (m ²)			weiß matt <input type="checkbox"/> V3
				363348H			braun-mix <input type="checkbox"/> V4
				Preisgr. W132 (m ²)			grau-blau <input type="checkbox"/> V4
					363351H		creme-cotto <input type="checkbox"/> V4
					Preisgr. W421 (St.)		
						363349H	
						Preisgr. 3x W499 (St.)	
						363350H	
						Preisgr. 3x W499 (St.)	



¹ Die Riegel Cabana variieren bewusst in der Farbigkeit. Bitte gemischt aus mehreren Kartons verlegen, damit sich ein gleichmäßiges Bild ergibt.
³ Abgabe der Dekorationselemente ausschließlich in vollen Kartons.
⁴ 3er Set





Detailreiche Möglichkeiten

Während Marmor in der Regel in großen Formaten eingesetzt wird, besteht die Marble & More Mosaikserie mit ihrer fast schon kleinteiligen Ästhetik und ihrer vielfältigen Farbigkeit. Anders als ihr natürliches Marmor-Vorbild ist diese Fliese unempfindlich gegen aggressive Medien wie Reinigungsmittel, Shampoos und Seifen. Trittsichere Varianten erweitern die verlegerischen Freiheiten von Planern und Architekten. Als Hytect-Fliesen sind Marble & More sehr pflegeleicht und sie sorgen für Hygiene. Zudem ist die Serie an Boden und Wand farblich auf die Serie Ascona abgestimmt.

Rendering

Mosaik 2,5 x 2,5 cm



Mosaikbogen 30 x 30 cm
carrara white, eben,
Mosaikbogen 30 x 30 cm,
carrara white, eben, R10/B



Mosaikbogen 30 x 30 cm
illusion beige, eben,
Mosaikbogen 30 x 30 cm
illusion beige, eben, R10/B

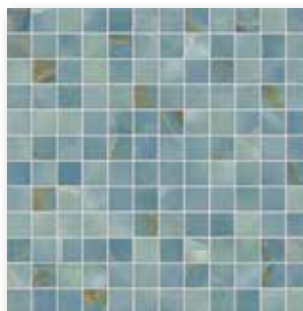

Mosaikbogen 30 x 30 cm
cielo, eben,
Mosaikbogen 30 x 30 cm,
cielo, eben, R10/B



Mosaikbogen 30 x 30 cm,
labradorit blue, eben,
Mosaikbogen 30 x 30 cm
labradorit blue, eben, R10/B



Mosaikbogen 30 x 30 cm
verde alpi, eben,
Mosaikbogen 30 x 30 cm
verde alpi, eben, R10/B

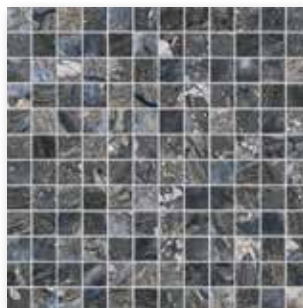

Mosaikbogen 30 x 30 cm
illusion dark, eben,
Mosaikbogen 30 x 30 cm
illusion dark, eben, R10/B



Rückseitig thermoplastisch verklebte Mosaik von Agrob Buchtal sind nicht nur im Trockenbereich, sondern auch bedenkenlos im Unterwasserbereich (z. B. Schwimmbecken/Whirlpool) sowie im dauernassbelasteten Bereich einsetzbar.

Mosaik

2,5 x 2,5 cm

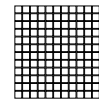

Bogen: 297 x 297 mm



						2,5 x 2,5 / 1 x 1	Nennmaß - cm/in
						23 x 23 x 6,5 mm	Herstellmaß
						eben, glänzend	Oberfläche
						11,000	m ² - Stück
						12,100	m ² - kg
						11	Paket - Stück
						1,000	Paket - m ²
						12,100	Paket - kg
						48,000	Palette - m ²
						580,800	Palette - kg
						Blb	Produktnorm
						1	Trittsicherheit
						431117H	Belastung
						Preisgr. A229 (m ²)	3 carrara white <input type="checkbox"/> V4
						431118H	3 illusion beige <input type="checkbox"/> V4
						Preisgr. A229 (m ²)	3 cielo <input type="checkbox"/> V4
						431119H	2 labradorit blue <input type="checkbox"/> V4
						Preisgr. A229 (m ²)	2 verde alpi <input type="checkbox"/> V4
						431120H	2 illusion dark <input type="checkbox"/> V4
						Preisgr. A229 (m ²)	
						431121H	
						Preisgr. A229 (m ²)	
						431122H	
						Preisgr. A229 (m ²)	



Mosaik

2,5 x 2,5 cm

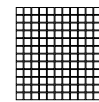

Bogen: 297 x 297 mm



						2,5 x 2,5 / 1 x 1	Nennmaß - cm/in
						23 x 23 x 6,5 mm	Herstellmaß
						eben, matt	Oberfläche
						11,000	m ² - Stück
						12,100	m ² - kg
						11	Paket - Stück
						1,000	Paket - m ²
						12,100	Paket - kg
						48,000	Palette - m ²
						580,800	Palette - kg
						Blb	Produktnorm
						R10/B	Trittsicherheit
						1	Belastung
						431111H	4 carrara white <input type="checkbox"/> V4
						Preisgr. A238 (m ²)	4 illusion beige <input type="checkbox"/> V4
						431112H	4 cielo <input type="checkbox"/> V4
						Preisgr. A238 (m ²)	3 labradorit blue <input type="checkbox"/> V4
						431113H	2 verde alpi <input type="checkbox"/> V4
						Preisgr. A238 (m ²)	4 illusion dark <input type="checkbox"/> V4
						431114H	
						Preisgr. A238 (m ²)	
						431115H	
						Preisgr. A238 (m ²)	
						431116H	
						Preisgr. A238 (m ²)	



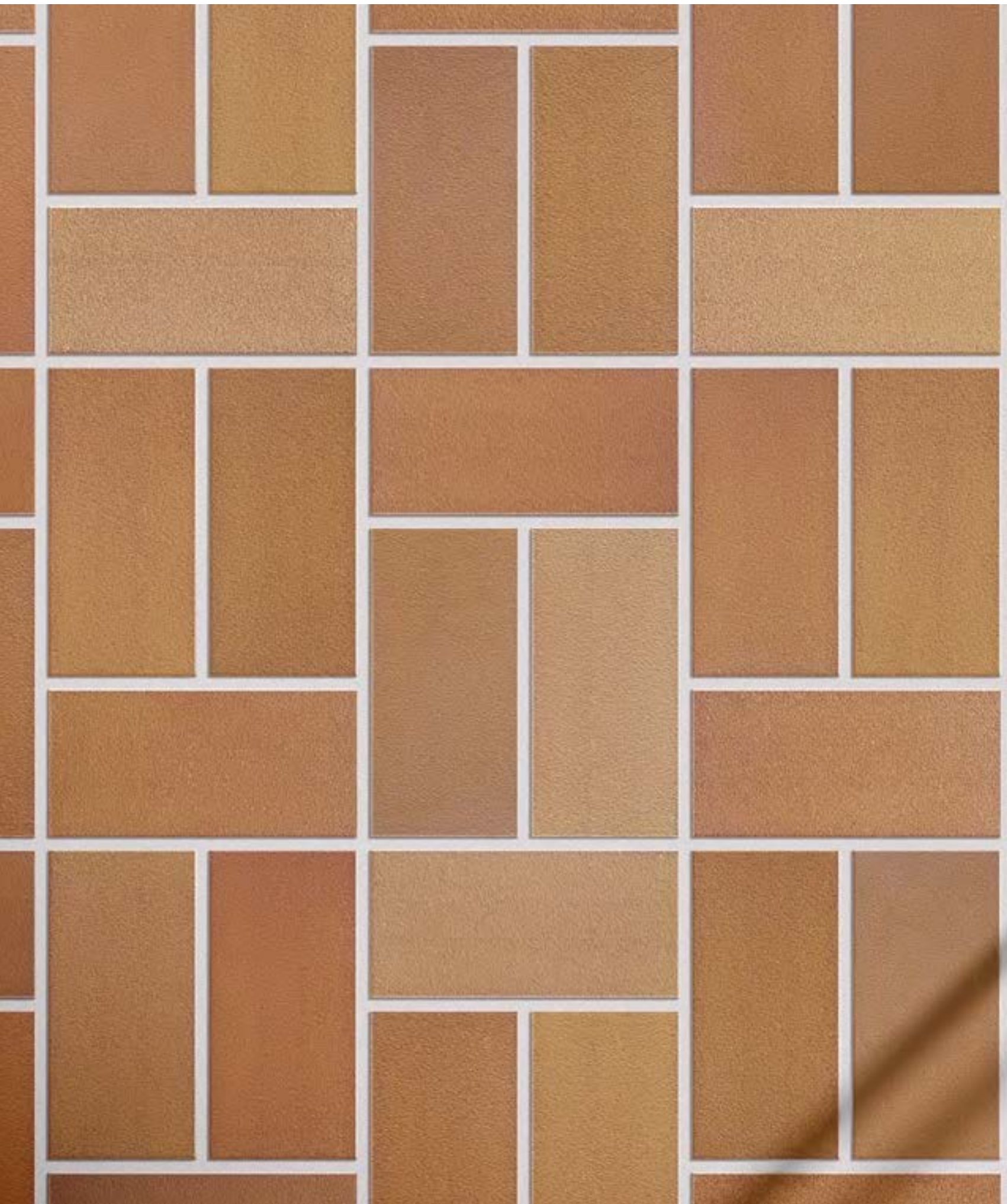

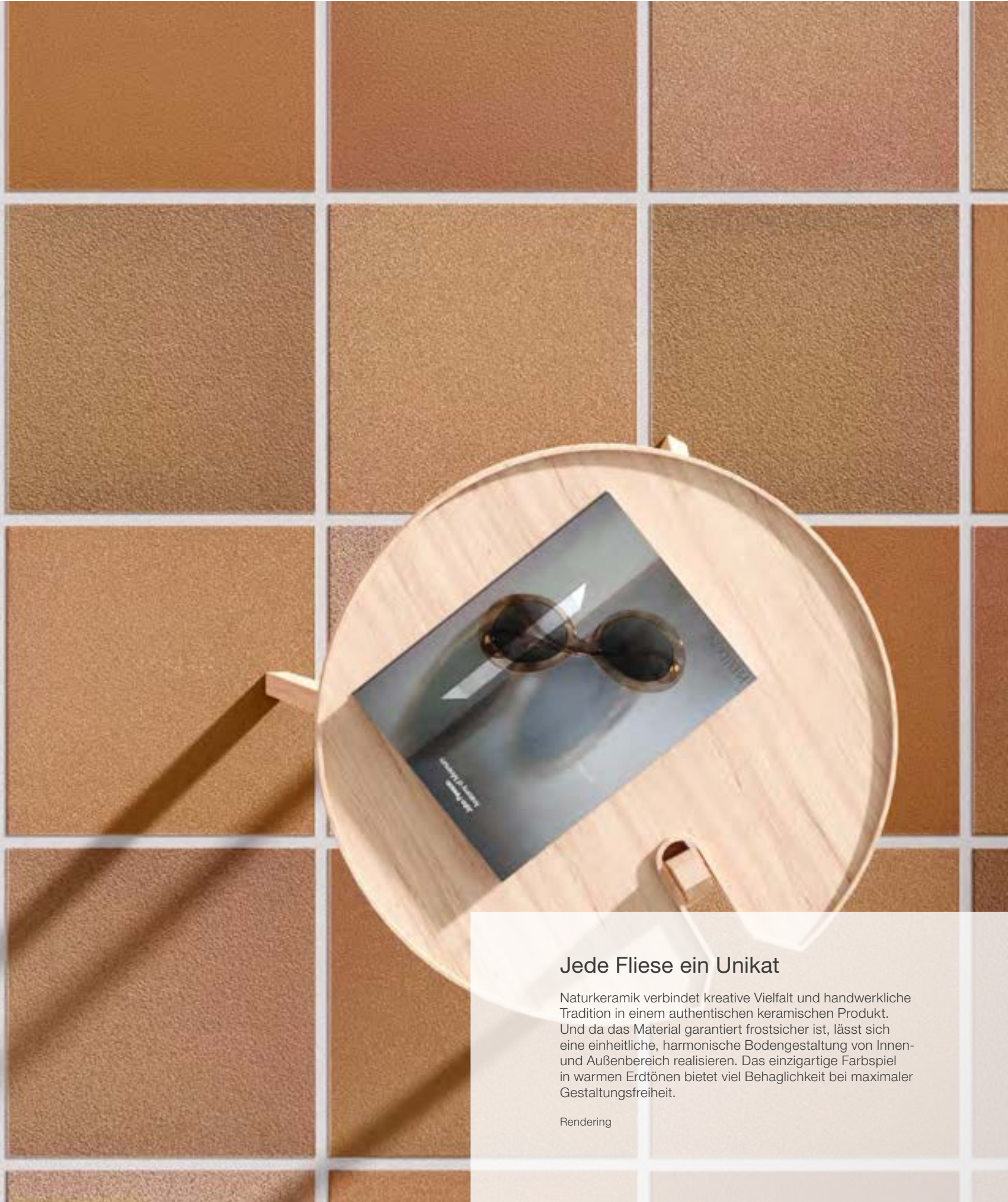

Jede Fliese ein Unikat

Naturkeramik verbindet kreative Vielfalt und handwerkliche Tradition in einem authentischen keramischen Produkt. Und da das Material garantiert frostsicher ist, lässt sich eine einheitliche, harmonische Bodengestaltung von Innen- und Außenbereich realisieren. Das einzigartige Farbspiel in warmen Erdtönen bietet viel Behaglichkeit bei maximaler Gestaltungsfreiheit.

Rendering



R11/A R11/B

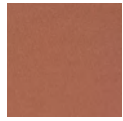

herbstlaub



portofino

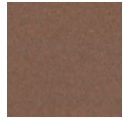

braunpalette



Bodenplatte 12,5 x 25 cm, eben, R11/A
Bodenplatte 12,5 x 25 cm, eben, R11/B



Bodenplatte 25 x 25 cm, eben, R11/A
Bodenplatte 25 x 25 cm, eben R11/B

Bodenplatten

12,5 x 25 cm



25 x 25 cm



					1010	1630	Formatnummer
					12,5 x 25 / 5 x 10	25 x 25 / 10 x 10	Nennmaß - cm/in
					115 x 240 x 10 mm	240 x 240 x 10 mm	Herstellmaß
					eben, matt	eben, matt	Oberfläche
					33,000/m ²	16,000/m ²	m ² /m - Stück
					19,800/m ²	20,160/m ²	m ² /m - kg
					26	11	Paket - Stück/Paar
					0,788 m ²	0,688 m ²	Paket - m/m ²
					15,600	13,860	Paket - kg
					66,182	55,688	Palette - m ²
					1.310,400	1.122,600	Palette - kg
					Alla	Alla	Produktnorm
					siehe unten	siehe unten	Trittsicherheit
					2	2	Belastung
					R11/B	R11/B	herbstlaub <input type="checkbox"/> V3
					010D-1010	010D-1630	
					Preisgr. A109 (m ²)	Preisgr. A124 (m ²)	
					R11/A	R11/A	portofino <input type="checkbox"/> V4
					948D-1010	948D-1630	
					Preisgr. A109 (m ²)	Preisgr. A124 (m ²)	
					R11/B	R11/B	braunpalette <input type="checkbox"/> V4
					950D-1010	950D-1630	
					Preisgr. A109 (m ²)	Preisgr. A124 (m ²)	

Schenkelplatten 12,5 x 25 cm auf Anfrage geklebt machbar. Preisstellung wird objektspezifisch kalkuliert.







Härtetest: Jedem Druck gewachsen

Böden in Supermärkten sollen ansprechend, pflegeleicht und enorm belastbar sein. Diese Ansprüche erfüllt Agrob Buchtal mit überstarken Fliesen und Platten in Dicken bis zu 14 mm. Mit Bruchfestigkeitswerten, die erheblich über den einschlägigen Normen liegen, halten die rektifizierten Großformate auch das Befahren mit Gabelstaplern und Hubwagen ohne Probleme aus. Dabei verbindet sich extreme Robustheit mit attraktiver Optik: Feinsteinzeug-Oberflächen in vielen Farbstellungen bieten alle Voraussetzungen für eine repräsentative Gestaltung.

Design Area Pro

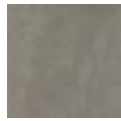

kiesel



sandweiß

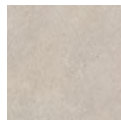

sandgrau



Bodenfliese 60 x 60 cm, überstark, eben, R10



Design Basis Pro



betongrau



aschbraun



sandbeige

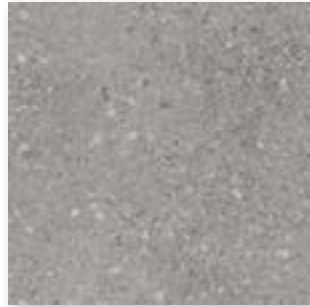

Bodenfliese 30 x 30 cm, überstark, eben, R10



Bodenfliese 30 x 60 cm, überstark, eben, R10



Bodenfliese 60 x 60 cm, überstark, eben, R10

 Die Formate 30 x 60 cm und 60 x 60 cm werden konisch rektifiziert.



Made in
Germany



R10



Design Like



cement



Bodenfliese 60 x 60 cm, überstark, strukturiert, R10

Design Portland



anthrazit



Bodenfliese 30 x 30 cm, überstark, eben, R10



Die Formate 30 x 60 cm und 60 x 60 cm werden konisch rektifiziert.



Design Trio



Terrazzo black



Terrazzo red



Terrazzo ivory

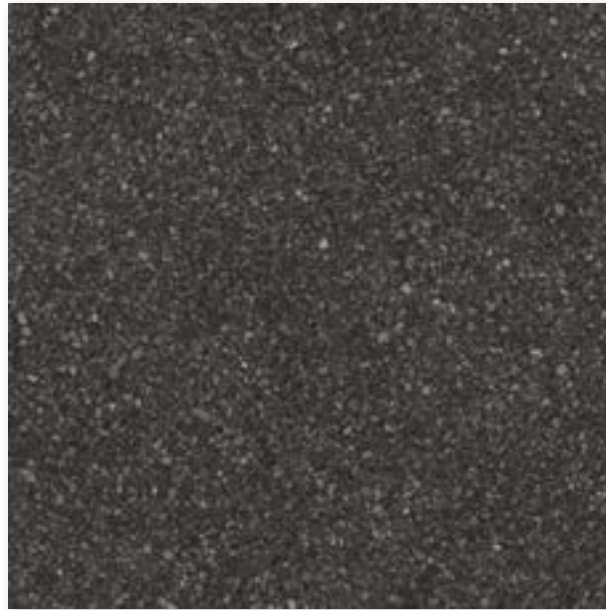

Bodenfliese 60 x 60 cm, überstark, eben, R10

Design Walden



classic oak



relax beige



smokey brown



Bodenfliese 30 x 60 cm, überstark, strukturiert, R10

 Die Formate 30 x 60 cm und 60 x 60 cm werden konisch rektifiziert.

Bodenfliesen²

30 x 30 cm



30 x 30 cm



30 x 60 cm¹

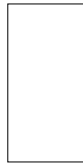

30 x 60 cm¹



60 x 60 cm¹

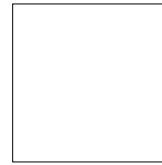

60 x 60 cm^{1/3}

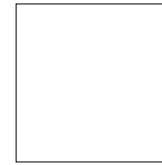

60 x 60 cm¹

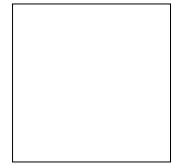

protected

	<i>Design Portland</i>	<i>Design Basis Pro</i>	<i>Design Basis Pro</i>	<i>Design Walden</i>	<i>Design Basis Pro</i>	<i>Design Area Pro</i>	<i>Design Like</i>
Nennmaß - cm/in	30 x 30 / 12 x 12	30 x 30 / 12 x 12	30 x 60 / 12 x 24	30 x 60 / 12 x 24	60 x 60 / 24 x 24	60 x 60 / 24 x 24	60 x 60 / 24 x 24
Herstellmaß	297 x 297 x 14 mm	297 x 297 x 14 mm	300 x 600 x 14 mm	300 x 600 x 14 mm	600 x 600 x 14 mm	600 x 600 x 14 mm	600 x 600 x 14 mm
Oberfläche	eben, matt	eben, matt	eben, matt	strukturiert, matt	eben, matt	eben, matt	strukturiert, matt
m ² - Stück	11,337	11,337	5,589	5,589	2,778	2,778	2,778
m ² - kg	32,027	32,027	32,159	32,159	31,669	31,669	31,669
Paket - Stück	8	8	4	4	2	2	2
Paket - m ²	0,706	0,706	0,716	0,716	0,720	0,720	0,720
Paket - kg	22,600	22,600	23,016	23,016	22,800	22,800	22,800
Palette - m ²	33,871	33,871	28,628	28,628	30,238	30,238	30,238
Palette - kg	1.084,800	1.084,800	920,640	920,640	957,600	957,600	957,600
Produktnorm	Bla	Bla	Bla	Bla	Bla	Bla	Bla
Trittsicherheit	R10	R10	R10	R10	R10	R10	R10
Belastung	4	4	3	3	4	4	4
Portland	434194						
anthrazit <input type="checkbox"/> V3							
Basis Pro		430993	430995		430977		
betongrau <input type="checkbox"/> V2							
Basis Pro			430996		430978		
aschbraun <input type="checkbox"/> V2							
Basis Pro			430997		430979		
sandbeige <input type="checkbox"/> V2							
Walden				432292			
classic oak <input type="checkbox"/> V2							
Walden				432293			
relax beige <input type="checkbox"/> V2							
Walden				432294			
smokey brown <input type="checkbox"/> V2							
Area Pro						430200H	
kiesel <input type="checkbox"/> V2							
Area Pro						430201H	
sandweiß <input type="checkbox"/> V2							
Area Pro						430202H	
sandgrau <input type="checkbox"/> V2							
Like							430684
cement <input type="checkbox"/> V2							

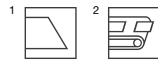

³ Mit Hytect-Veredelung

Preisstellungen werden objektspezifisch kalkuliert

Bodenfliese^{1/2}

60 x 60 cm

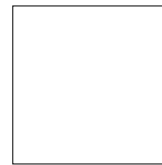

Design Trio

					60 x 60 / 24 x 24	Nennmaß - cm/in
					600 x 600 x 14 mm	Herstellmaß
					strukturiert, matt	Oberfläche
					2,778	m ² - Stück
					31,669	m ² - kg
					2	Paket - Stück
					0,720	Paket - m ²
					22,800	Paket - kg
					30,238	Palette - m ²
					957,600	Palette - kg
					Bla	Produktnorm
					R10	Trittsicherheit
					4	Belastung
					431692H	Trio
					431693H	terrazzo red <input type="checkbox"/> V4
					431694H	Trio
						terrazzo black <input type="checkbox"/> V4
						Trio
						terrazzo ivory <input type="checkbox"/> V4

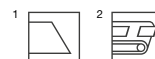

Preisstellungen werden objektspezifisch kalkuliert



Höhenausgleichsmatte Nivella 30 x 60 cm



Nivella Höhengleichsmatte

Nivella dient als Problemlöser für den Ausgleich des Höhenunterschieds zwischen dem Mosaik (6,5 mm) und den Wand-/Bodenfliesen (8 mm). Sie sorgt somit für eine durchgehend ebene Fläche und damit vollendete Raumwirkung. Nivella ist ideal für die Arbeit mit kleinformatischen Belägen und geeignet für den Innen- und Außenbereich. Ein weiterer Vorteil ist von akustischer Natur: wirkungsvoll minimiert Nivella eventuelle Hohlklang-Effekte. Auf das jeweilig benötigte Maß zugeschnitten, wird die Matte vollflächig in den Verlegemörtel gedrückt.



Höhenausgleichsmatte

30 x 60 cm



						30 x 60 / 12 x 24	Nennmaß - cm/in
						316 x 632 x 2,5 mm	Herstellmaß
						5 Bögen	Oberfläche
						0,380	m ² - Stück
						5 Bögen	m ² - kg
						1,000	Paket - Stück
						0,380	Paket - m ²
						30,000	Paket - kg
						11,400	Palette - m ²
							Palette - kg
							Produktnorm
							Trittsicherheit
						0002	
						Preisgr. A22 (m ²)	blau

Technische Daten

Brandklasse: B2
 Verkehrslast bis: 2 KN/m² (Kategorie A1-B1)
 Punktlast für Fliesen im Format 1 x 1 cm:
 Nicht größer als 0,25 KN/cm²
 (entspricht ca. 25 kg/cm²)

Gesonderte Konditionierung bei Zubehör

Höhenausgleichsmatte für den gewerblichen und privaten Einsatz im Innen- und Außenbereich (Wand & Boden)

Eigenschaften:

- Höhengleichend
- Speziell unter kleinformatischen Belägen
- Kein Hohlklang
- Hohe Haftzugfestigkeit

Produktbeschreibung:

Nivella ist eine spezielle Höhengleichsmatte zur idealen Kombination der Mosaik (6,5 mm) mit den angebotenen Wand-/Bodenfliesen (8 mm). Hohe Haftzugwerte sowie Biege-, Zug- und Druckfestigkeit sind prägnante Leistungsmerkmale dieser Höhengleichsmatte.

Untergründe:

Untergründe, auf denen Nivella zum Einsatz kommen soll, müssen grundsätzlich auf Ebenheit, Tragfähigkeit und Oberflächenfestigkeit geprüft werden. Höhenversätze sind auszuschließen. Haftungsmindernde Schichten sind durch Schleifen zu entfernen. Grundierungen, abgestimmt auf Untergrund,

Verlegemörtel bzw. Ausgleichsschichten sind gegebenenfalls vorzusehen. Ausgleichspachtelungen, Höhengleiche sind vor dem Verlegen der Höhengleichsmatte auch für die angrenzenden Beläge herzustellen. Feuchtigkeitsempfindliche Untergründe sind durch entsprechende Abdichtungsmaßnahmen zu schützen.

- Zementäre Untergründe wie Estriche, Beton mind. 28 Tage alt, junge Estriche nach Begehbarkeit bis 7 Tage
- Calciumsulfatestriche mit Restfeuchten < 1%
- Gussasphaltestriche
- Magnesia/Steinholzestriche
- Heizestriche
- Trockenestriche
- Alte, feste keramische Beläge
- Alte Natursteinbeläge
- Gipskartonplatten
- Faserzementplatten
- Putze

Verarbeitung:

Auf den vorbereiteten Untergrund geeigneten Fliesenkleber nach DIN EN 12004 C2 und DIN EN 12002 S1 auftragen. Die Matten der Nivella werden auf das erforderliche Maß zugeschnitten und vollflächig in den zuvor aufgetragenen Kleber eingebettet und dicht gestoßen. Der Fliesenkleber wird gleichmäßig in die Vertiefungen (Gitterstruktur) eingespachtelt. Die Gitterhohlräume müssen hierbei überall zu 100% gefüllt werden. Mit der entsprechenden Zahnleiste den Verlegemörtel aufkämmen und das Mosaik verlegen. Frühestens nach 24 Stunden werden die Flächen mit einem kunststoffvergüteten Fugenmörtel verfugt.

Achtung:

Die richtige und damit erfolgreiche Anwendung unserer Produkte unterliegt nicht unserer Kontrolle. Eine Gewährleistung kann deshalb nur für die Güte unserer Erzeugnisse im Rahmen unserer Verkaufs- und Lieferbedingungen, nicht aber für die erfolgreiche Verarbeitung übernommen werden. Veränderungen, die einen technischen Fortschritt bedeuten, behalten wir uns vor.

Lotrechte Nutzlasten für Decken nach DIN 1055-3 (Auszug)				
Kategorie	Nutzung	Beispiele	Flächenlast qk (kN/m ²)	Einzellast Qk (kN)
A1	Spitzböden	Dachraum bis 1,8 m lichter Höhe	1,0	1,0
A2	Wohn- und Aufenthaltsräume	Räume mit ausreichender Querverteilung der Lasten wie Räume und Flure in Wohngebäuden, Hotelzimmern, sowie Bettenräume in Krankenhäusern	1,5	-
A3		wie A2, aber ohne ausreichende Querverteilung	2,0	1,0
B1	Büro-, Arbeitsflächen	Flure in Bürogebäuden, Büroflächen, Arztpraxen, Stationsräume, Aufenthaltsräume einschl. der Flure, Kleinviehställe	2,0	2,0





Lebendig und vielfältig

Durch ihren modularen Aufbau in Farben und Formaten ermöglicht die trittsichere Feinsteinzeugserie Nova individuelle Lösungen in unterschiedlichsten Einsatzbereichen. Die von Terrazzoböden inspirierte Optik umfasst acht fein abgestimmte Farbnuancen von cremebeige über mittelgrau bis hin zu anthrazit bunt.

Rendering / Architekt: VSBL, Belgrad, Serbien



R10/A R10/B R11/C



cremebeige

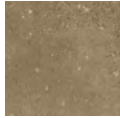

mittelbraun



mittelgrau



basalt



anthrazit



cremebeige bunt

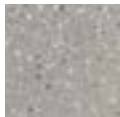

mittelgrau bunt



anthrazit bunt



Bodenfliese 15 x 15 cm, eben, R10/B
Bodenfliese 15 x 15 cm, eben, R11/C



Riegelformat 10 x 60 cm, eben, R10/A



Riegelformat 15 x 60 cm, eben, R10/A



Bodenfliese 30 x 60 cm, eben, R10/A
Bodenfliese 30 x 60 cm, eben, R11/B



Bodenfliese 60 x 60 cm, eben, R10/A



Bodenfliese 60 x 120 cm, eben, R10/A



R10/A R10/B



Treppenfliese 30 x 60 cm (rilliert), eben, R10/A

Mosaik 5 x 5 cm



Mosaikbogen 30 x 30 cm, eben, R10/B



Hohlkehlssockel 10 x 60 cm, eben



Sockel, gerundet 7 x 60 cm, eben



Treppenfliese mit Schräge 31 x 145 cm, eben, R10/A



Setzstufe 28 x 145 cm, eben

Mosaik: Verklebung rückseitig auf Glasfasernetz,
Bogen: 297 x 297 mm

Mosaik^{1/3}

Bodenfliesen

5 x 5 cm



15 x 15 cm



15 x 15 cm



10 x 60 cm^{1/2}



15 x 60 cm^{1/2}



Bogen: 297 x 297 mm

Riegelformat

Riegelformat

	5 x 5 / 2 x 2	15 x 15 / 6 x 6	15 x 15 / 6 x 6	10 x 60 / 4 x 24	15 x 60 / 6 x 24	Nennmaß - cm/in
	47 x 47 x 10,5 mm	147 x 147 x 8 mm	147 x 147 x 8 mm	97 x 597 x 10,5 mm	147 x 597 x 10,5 mm	Herstellmaß
	eben, matt	eben, matt	eben, matt	eben, matt	eben, matt	Oberfläche
	11,111 Bögen	44,444	44,444	16,667	11,111	m ² - Stück
	21,966	17,555	17,555	21,967	21,966	m ² - kg
	11 Bögen	35	35	15	11	Paket - Stück
	0,990	0,788	0,788	0,900	0,990	Paket - m ²
	21,747	13,825	13,825	19,770	21,747	Paket - kg
	29,700	63,001	63,001	35,999	39,600	Palette - m ²
	652,410	1.106,000	1.106,000	790,800	869,880	Palette - kg
	Ala	Bla	Bla	Ala	Ala	Produktnorm
	R10/B	R10/B	R11/C	R10/A	R10/A	Trittsicherheit
	2	2	2	2	2	Belastung
	431801H	431807H	431873H	<i>431817H</i>	<i>431823H</i>	cremebeige <input type="checkbox"/> V3
	Preisgr. A286 (m ²)	Preisgr. A142 (m ²)	Preisgr. A157 (m ²)	<i>Preisgr. A199</i> (m ²)	<i>Preisgr. A199</i> (m ²)	
	431802H	431808H	431874H	<i>431818H</i>	<i>431824H</i>	mittelbraun <input type="checkbox"/> V3
	Preisgr. A286 (m ²)	Preisgr. A142 (m ²)	Preisgr. A157 (m ²)	<i>Preisgr. A199</i> (m ²)	<i>Preisgr. A199</i> (m ²)	
	431803H	431809H	431875H	<i>431819H</i>	<i>431825H</i>	mittelgrau <input type="checkbox"/> V3
	Preisgr. A286 (m ²)	Preisgr. A142 (m ²)	Preisgr. A157 (m ²)	<i>Preisgr. A199</i> (m ²)	<i>Preisgr. A199</i> (m ²)	
	431804H	431810H	431876H	<i>431820H</i>	<i>431826H</i>	basalt <input type="checkbox"/> V3
	Preisgr. A286 (m ²)	Preisgr. A142 (m ²)	Preisgr. A157 (m ²)	<i>Preisgr. A199</i> (m ²)	<i>Preisgr. A199</i> (m ²)	
	431805H	431811H	431877H	<i>431821H</i>	<i>431827H</i>	anthrazit <input type="checkbox"/> V3
	Preisgr. A286 (m ²)	Preisgr. A142 (m ²)	Preisgr. A157 (m ²)	<i>Preisgr. A199</i> (m ²)	<i>Preisgr. A199</i> (m ²)	
	431744H			<i>431746H</i>	<i>431748H</i>	cremebeige <input type="checkbox"/> V4
	Preisgr. A286 (m ²)			<i>Preisgr. A199</i> (m ²)	<i>Preisgr. A199</i> (m ²)	
	431745H			<i>431747H</i>	<i>431749H</i>	bunt <input type="checkbox"/> V4
	Preisgr. A286 (m ²)			<i>Preisgr. A199</i> (m ²)	<i>Preisgr. A199</i> (m ²)	
	431806H			<i>431822H</i>	<i>431828H</i>	anthrazit <input type="checkbox"/> V4
	Preisgr. A286 (m ²)			<i>Preisgr. A199</i> (m ²)	<i>Preisgr. A199</i> (m ²)	
						bunt <input type="checkbox"/> V4



³ Verklebung auf Glasfasernetz



Bodenfliesen¹

30 x 60 cm



30 x 60 cm

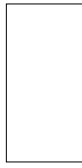

60 x 60 cm²



60 x 120 cm²



Nennmaß - cm/in	30 x 60 / 12 x 24	30 x 60 / 12 x 24	60 x 60 / 24 x 24	60 x 120 / 24 x 48			
Herstellmaß	297 x 597 x 10,5 mm	297 x 597 x 10,5 mm	597 x 597 x 10,5 mm	597 x 1197 x 10,5 mm			
Oberfläche	eben, matt	eben, matt	eben, matt	eben, matt			
m ² - Stück	5,556	5,556	2,778	1,388			
m ² - kg	21,974	21,974	21,996	21,996			
Paket - Stück	6	6	3	2			
Paket - m ²	1,080	1,080	1,080	1,441			
Paket - kg	23,730	23,730	23,754	31,672			
Palette - m ²	43,197	43,197	32,397	30,259			
Palette - kg	949,200	949,200	712,620	665,112			
Produktnorm	Ala	Ala	Ala	Ala			
Trittsicherheit	R10/A	R11/B	R10/A	R10/A			
Belastung	2	2	2	2			
cremebeige <input type="checkbox"/> V3	431829H Preisgr. A121 (m ²)	431835H Preisgr. A154 (m ²)	431840H Preisgr. A136 (m ²)	431846H Preisgr. A154 (m ²)			
mittelbraun <input type="checkbox"/> V3	431830H Preisgr. A121 (m ²)	431836H Preisgr. A154 (m ²)	431841H Preisgr. A136 (m ²)	431847H Preisgr. A154 (m ²)			
mittelgrau <input type="checkbox"/> V3	431831H Preisgr. A121 (m ²)	431837H Preisgr. A154 (m ²)	431842H Preisgr. A136 (m ²)	431848H Preisgr. A154 (m ²)			
basalt <input type="checkbox"/> V3	431832H Preisgr. A121 (m ²)	431838H Preisgr. A154 (m ²)	431843H Preisgr. A136 (m ²)	431849H Preisgr. A154 (m ²)			
anthrazit <input type="checkbox"/> V3	431833H Preisgr. A121 (m ²)	431839H Preisgr. A154 (m ²)	431844H Preisgr. A136 (m ²)	431850H Preisgr. A154 (m ²)			
cremebeige <input type="checkbox"/> V4	431750H Preisgr. A121 (m ²)		431752H Preisgr. A136 (m ²)	431754H Preisgr. A154 (m ²)			
bunt <input type="checkbox"/> V4	431751H Preisgr. A121 (m ²)		431753H Preisgr. A136 (m ²)	431755H Preisgr. A154 (m ²)			
mittelgrau <input type="checkbox"/> V4	431834H Preisgr. A121 (m ²)		431845H Preisgr. A136 (m ²)	431851H Preisgr. A154 (m ²)			
anthrazit <input type="checkbox"/> V4	431834H Preisgr. A121 (m ²)		431845H Preisgr. A136 (m ²)	431851H Preisgr. A154 (m ²)			
bunt <input type="checkbox"/> V4	431834H Preisgr. A121 (m ²)		431845H Preisgr. A136 (m ²)	431851H Preisgr. A154 (m ²)			



² Hohes Gewicht! Karton bitte nur zu Zweit transportieren.

Treppenfliese^{2/4}

30 x 60 cm

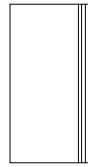

Treppenfliese mit Schräge^{2/3/4}

31 x 145 cm

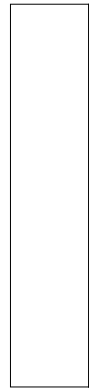

Setzstufe^{2/3/4}

28 x 145 cm



Sockel, gerundet¹

7 x 60 cm



Hohlkehlsockel, dekoriert^{1/2/5}

10 x 60 cm



	30 x 60 / 12 x 24	31 x 145 / 12 13/64 x 57	28 x 145 / 11 x 57	7 x 60 / 2 13/16 x 24	10 x 60 / 4 x 24	Nennmaß - cm/in
	297 x 597 x 10,5 mm	307 x 1447 x 10,5 mm	280 x 1447 x 10,5 mm	70 x 597 x 10,5 mm	100 x 597/35 x 9 mm	Herstellmaß
	eben, matt	eben, matt	eben, matt	eben, matt	eben, matt	Oberfläche
	1,667	0,690	0,690	1,667	1,667	m - Stück
	6,593	7,480	6,716	1,554	2,000	m - kg
	6	2	2	15	20	Paket - Stück
	3,599 m	2,899 m	2,899 m	8,998	11,998	Paket - m ² /m
	23,730	21,682	19,466	13,980	24,000	Paket - kg
						Palette - m ²
						Palette - kg
	Ala	Ala	Ala	Ala	Alb	Produktnorm
	R10/A	R10/A	R10/A			Trittsicherheit
	2	2	2			Belastung
	431852H	431797H	431785H	431864H	431887H	
	Preisgr. A475 (St.)	Preisgr. A560 (St.)	Preisgr. A528 (St.)	Preisgr. A438 (St.)	Preisgr. A445 (St.)	cremebeige <input type="checkbox"/> V3
	431853H	431715H	431719H	431865H	431893H	
	Preisgr. A475 (St.)	Preisgr. A560 (St.)	Preisgr. A528 (St.)	Preisgr. A438 (St.)	Preisgr. A445 (St.)	mittelbraun <input type="checkbox"/> V3
	431854H	431736H	431765H	431866H	431894H	
	Preisgr. A475 (St.)	Preisgr. A560 (St.)	Preisgr. A528 (St.)	Preisgr. A438 (St.)	Preisgr. A445 (St.)	mittelgrau <input type="checkbox"/> V3
	431855H	431794H	431727H	431867H	431786H	
	Preisgr. A475 (St.)	Preisgr. A560 (St.)	Preisgr. A528 (St.)	Preisgr. A438 (St.)	Preisgr. A445 (St.)	basalt <input type="checkbox"/> V3
	431856H	430599H	431720H	431868H	431787H	
	Preisgr. A475 (St.)	Preisgr. A560 (St.)	Preisgr. A528 (St.)	Preisgr. A438 (St.)	Preisgr. A445 (St.)	anthrazit <input type="checkbox"/> V3
	431756H	431716H	431721H	431762H		
	Preisgr. A475 (St.)	Preisgr. A560 (St.)	Preisgr. A528 (St.)	Preisgr. A438 (St.)		cremebeige <input type="checkbox"/> V4
	431757H	431717H	431722H	431763H		
	Preisgr. A475 (St.)	Preisgr. A560 (St.)	Preisgr. A528 (St.)	Preisgr. A438 (St.)		bunt <input type="checkbox"/> V4
	431857H	431718H	431723H	431869H		
	Preisgr. A475 (St.)	Preisgr. A560 (St.)	Preisgr. A528 (St.)	Preisgr. A438 (St.)		bunt <input type="checkbox"/> V4



¹ Nur an den zwei kurzen Seiten rektifiziert. Längsseite kann nicht rektifiziert werden.

² Details siehe S. 538. Weitere Lösungen zu Treppenausführungen siehe Serie Area Pro

⁵ Produktionsbedingte Farbabweichungen zum angrenzenden Belag bei liegender Verlegung sind nicht reklamationsfähig







Pflegeleichter Holz-Look

Mit Oak gelingt eine elegante und raffinierte Holzoptik – in Eiche natur oder Eiche anthrazit. Die Bodenserie verfügt über 5 Formatvarianten, Treppenelemente, Sockel sowie ein 6-eckiges Bodendekor mit 30 x 35 cm – alle mit Hytect-Oberfläche – für viel Gestaltungsspielraum im einheitlichen Look. Für modernen Touch sorgen drei Paneelen-Formate mit 30 x 120, 40 x 120 und 60 x 120 cm. Durch die großen Formate kommt die Maserung besonders gut zur Geltung.

Studioaufnahme



Eiche natur



Eiche anthrazit



Bodenfliese 15 x 90 cm, strukturiert, R10/A



Bodenfliese 30 x 90 cm, strukturiert, R10/A



Bodenfliese 30 x 120 cm, strukturiert, R10/A



Bodenfliese 40 x 120 cm, strukturiert, R10/A



Bodenfliese 60 x 120 cm, strukturiert, R10/A



Treppenfliese 30 x 120 cm (rilliert), strukturiert, R10/A

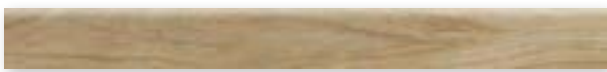

Sockel, gerundet 6 x 60 cm, strukturiert

Dekorationselemente



Dekorfliese Hexagon 30 x 35 cm,
Eiche natur, strukturiert, R10/A



Dekorfliese Hexagon 30 x 35 cm,
Eiche anthrazit, strukturiert, R10/A

Verklebung rückseitig auf Glasfasernetz,
Bogen: 298 x 344,1 mm.

Dekorationselemente³

30 x 35 cm



Dekorfliese Hexagon
Bogen: 298 x 344,1 mm



Nennmaß - cm/in	30 x 35 / 12 x 14						
Herstellmaß	298 x 344,1 x 8 mm						
Oberfläche	strukturiert, matt						
m - Stück	3,333						
m - kg	4,166						
Paket - Stück	3						
Paket - m	0,900						
Paket - kg	3,750						
Produktnorm	Alb						
Trittsicherheit	R10/A						
Belastung	2						
Eiche natur <input type="checkbox"/> V4	8471-B698HK Preisgr. W518 (St.)						
Eiche anthrazit <input type="checkbox"/> V3	8472-B698HK Preisgr. W518 (St.)						



Bodenfliesen¹

15 x 90 cm²



30 x 90 cm

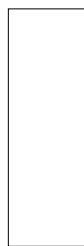

30 x 120 cm



40 x 120 cm



60 x 120 cm⁴

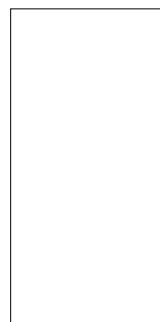

30 x 120 cm



6 x 60 cm



Treppenfliese^{1/2}

Sockel, gerundet¹



Nennmaß - cm/in	15 x 90 / 6 x 36	30 x 90 / 12 x 36	30 x 120 / 12 x 48	40 x 120 / 16 x 48	60 x 120 / 24 x 48	30 x 120 / 12 x 48	6 x 60 / 2 3/8 x 24
Herstellmaß	147 x 897 x 8 mm	297 x 897 x 8 mm	297 x 1197 x 8 mm	397 x 1197 x 8 mm	597 x 1197 x 8 mm	297 x 1197 x 8 mm	60 x 597 x 8 mm
Oberfläche	strukturiert, matt	strukturiert, matt	strukturiert, matt	strukturiert, matt	strukturiert, matt	strukturiert, matt	strukturiert, matt
m ² /m - Stück	7,407/m ²	3,704/m ²	2,778/m ²	2,083/m ²	1,388/m ²	0,833/m	1,667/m
m ² /m - kg	17,495/m ²	17,501/m ²	17,501/m ²	17,497/m ²	17,489/m ²	5,248/m	1,100/m
Paket - Stück	8	5	4	3	2	4	27
Paket - m ² /m	1,080 m ²	1,350 m ²	1,440 m ²	1,440 m ²	1,441 m ²	4,802 m	16,197 m
Paket - kg	18,896	23,625	25,200	25,200	25,200	25,200	17,820
Palette - m ²	43,202	40,497	43,197	51,848	36,023		
Palette - kg	755,840	708,750	756,000	907,200	630,000		
Produktnorm	Alb	Alb	Alb	Alb	Alb	Alb	Alb
Trittsicherheit	R10/A	R10/A	R10/A	R10/A	R10/A	R10/A	R10/A
Belastung	2	2	2	2	2	2	2
Eiche natur <input type="checkbox"/> V4	8471-B695HK Preisgr. W171 (m ²)	8471-B690HK Preisgr. W162 (m ²)	8471-B620HK Preisgr. W171 (m ²)	8471-B660HK Preisgr. W171 (m ²)	8471-B670HK Preisgr. W171 (m ²)	8471-B629HK Preisgr. W559 (St.)	8471-B610HK Preisgr. W439 (St.)
Eiche anthrazit <input type="checkbox"/> V3	8472-B695HK Preisgr. W171 (m ²)	8472-B690HK Preisgr. W162 (m ²)	8472-B620HK Preisgr. W171 (m ²)	8472-B660HK Preisgr. W171 (m ²)	8472-B670HK Preisgr. W171 (m ²)	8472-B629HK Preisgr. W559 (St.)	8472-B610HK Preisgr. W439 (St.)

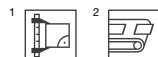

³ Abgabe der Dekorationselemente ausschließlich in vollen Kartons.
⁴ Hohes Gewicht! Karton bitte nur zu Zweit transportieren.

Studioaufnahme







Meer aus Farben

Die Serie Ocean bietet eine vielfältige Farbpalette für Pools, Spas und Wellnessbereiche, die das Element Wasser in seiner ganzen Lebendigkeit widerspiegelt. Zarte Wolken- und feinkörnige Strukturen vermischen sich mit dem Schimmer der Sonnenreflexionen. Durch Digitaldruck und Glasurpigmente entstehen changierende Farben wie kristallklares Grün, karibisches Türkis oder tiefes Blau. Die Formate in Riegel- und Mosaikoptik eignen sich für atmosphärische und funktionale Poolgestaltungen und ergänzen sich perfekt mit Serien wie ChromaPlural.

Rendering

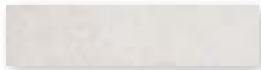

Wandfliese 6,2 x 25 cm
sunset beige, eben



Wandfliese 6,2 x 25 cm
wave blue, eben

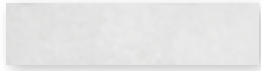

Wandfliese 6,2 x 25 cm
cliff white, eben



Wandfliese 6,2 x 25 cm
atlantic blue, eben

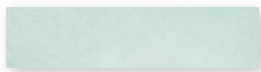

Wandfliese 6,2 x 25 cm
crystal green, eben

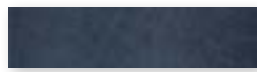

Wandfliese 6,2 x 25 cm
pacific blue, eben



Wandfliese 6,2 x 25 cm
island green, eben

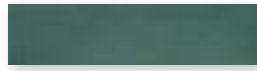

Wandfliese 6,2 x 25 cm
moos green, eben



Wandfliese 12,5 x 25 cm
sunset beige, eben



Wandfliese 12,5 x 25 cm
wave blue, eben

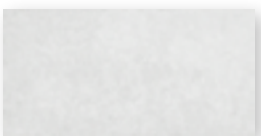

Wandfliese 12,5 x 25 cm
cliff white, eben



Wandfliese 12,5 x 25 cm
atlantic blue, eben

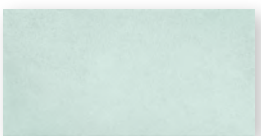

Wandfliese 12,5 x 25 cm
crystal green, eben



Wandfliese 12,5 x 25 cm
pacific blue, eben



Wandfliese 12,5 x 25 cm
island green, eben



Wandfliese 12,5 x 25 cm
moos green, eben



R10/B



Mosaik 2,5 x 2,5 cm



Mosaikbogen 30 x 30 cm
seaside beige, strukturiert,
Mosaikbogen 30 x 30 cm,
seaside beige, strukturiert, R10/B

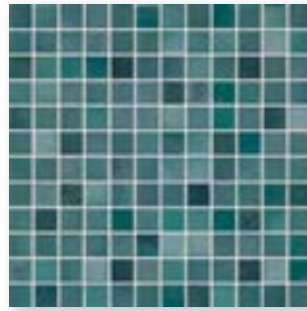

Mosaikbogen 30 x 30 cm
caribic blue, strukturiert,
Mosaikbogen 30 x 30 cm,
caribic blue, strukturiert, R10/B



Mosaikbogen 30 x 30 cm
ocean green, strukturiert,
Mosaikbogen 30 x 30 cm,
ocean green, strukturiert, R10/B



Mosaikbogen 30 x 30 cm
deep sea blue, strukturiert,
Mosaikbogen 30 x 30 cm,
deep sea blue, strukturiert, R10/B



Rückseitig thermoplastisch verklebte Mosaik von sind nicht nur im Trockenbereich, sondern auch bedenkenlos im Unterwasserbereich (z. B. Schwimmbecken/Whirlpool) sowie im dauernassbelasteten Bereich (z. B. Beckenumgänge/Duschen) einsetzbar.

Mosaik - 3 mm Fuge¹

Wandfliesen - 6 mm Fuge

2,5 x 2,5 cm

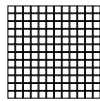

2,5 x 2,5 cm

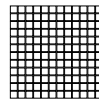
6,2 x 25 cm²

12,5 x 25 cm



Bogen 297 x 297 cm

Bogen 297 x 297 cm

Nennmaß - cm/in	2,5 x 2,5 / 1 x 1	2,5 x 2,5 / 1 x 1	6,2 x 25 / 2 1/2 x 10	12,5 x 25 / 5 x 10			
Herstellmaß	23 x 23 x 6,5 mm	23 x 23 x 6,5 mm	56 x 244 x 6 mm	119 x 244 x 6 mm			
Oberfläche	strukturiert, glänzend	strukturiert, matt	eben, glänzend	eben, glänzend			
m ² - Stück	11 Bögen	11 Bögen	64,000	32,000			
m ² - kg	12,100	12,100	10,880	12,160			
Paket - Stück	11 Bögen	11 Bögen	88	44			
Paket - m ²	1,000	1,000	1,375	1,375			
Paket - kg	12,100	12,100	14,960	16,720			
Palette - m ²	48,000	48,000	132,000	115,500			
Palette - kg	580,800	580,800	1.436,160	1.404,480			
Produktnorm	Blb	Blb	Alb	Alb			
Trittsicherheit		R10/B					
Belastung	1	1					
seaside beige <input type="checkbox"/>	436220H Preisgr. A250 (m ²)	436224H Preisgr. A259 (m ²)					
ocean green <input type="checkbox"/>	436221H Preisgr. A250 (m ²)	436225H Preisgr. A259 (m ²)					
caribic blue <input type="checkbox"/>	436222H Preisgr. A250 (m ²)	436226H Preisgr. A259 (m ²)					
deep sea blue <input type="checkbox"/>	436223H Preisgr. A250 (m ²)	436227H Preisgr. A259 (m ²)					
sunset beige <input type="checkbox"/>			436228H Preisgr. A175 (m ²)	436236H Preisgr. A175 (m ²)			
cliff white <input type="checkbox"/>			436229H Preisgr. A175 (m ²)	436237H Preisgr. A175 (m ²)			
crystal green <input type="checkbox"/>			436230H Preisgr. A175 (m ²)	436238H Preisgr. A175 (m ²)			
island green <input type="checkbox"/>			436231H Preisgr. A175 (m ²)	436239H Preisgr. A175 (m ²)			
wave blue <input type="checkbox"/>			436232H Preisgr. A175 (m ²)	436240H Preisgr. A175 (m ²)			
atlantic blue <input type="checkbox"/>			436233H Preisgr. A175 (m ²)	436241H Preisgr. A175 (m ²)			
pacific blue <input type="checkbox"/>			436234H Preisgr. A175 (m ²)	436242H Preisgr. A175 (m ²)			
moos green <input type="checkbox"/>			436235H Preisgr. A175 (m ²)	436243H Preisgr. A175 (m ²)			

² Lieferung als Doppelfliese; müssen örtlich gebrochen werden.

Die Serie Ocean ist ab 2. Quartal 2025 erhältlich.

Rendering







Mit einem Hauch von Nostalgie

Ursprüngliches neu erleben. Motive spielerisch kombinieren, im Innen- wie im Außenbereich: Mit zusätzlichen Mustern und Einzeldekoren ist der „Vintage-Baukasten“ der Serie Pattern umfangreich bestückt und fügt sich perfekt in jeden Wohnstil ein. Das Dekor Vanda bietet einen Mix aus 12 verschiedenen floralen und geometrischen Motiven. Als Einzelmotive bieten sich das florale Dekor Isola und das geometrische Dekor Baleno an. Alle drei Dekorvarianten harmonisieren durch ihre zarte Farbkomposition mit der Basisfliese in Zementgrau. Sie lassen sich aber auch zu vergrößerten Motiven aneinanderlegen – bis hin zum keramischen „Teppich“.

Rendering / Architekt: STELLWERK architekten, Dresden, Deutschland



Mosaik 2,5 x 2,5 cm



Mosaikbogen Vola 30 x 30 cm, mehrfarbig, eben



Mosaikbogen Vola 30 x 30 cm, beige-braun, eben

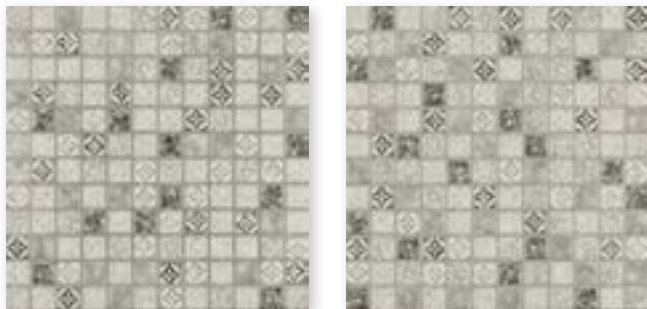

Mosaikbogen Vola 30 x 30 cm, grau, eben

Mosaik 5 x 5 cm



Mosaikbogen Vola 30 x 30 cm, mehrfarbig, eben, R10/B

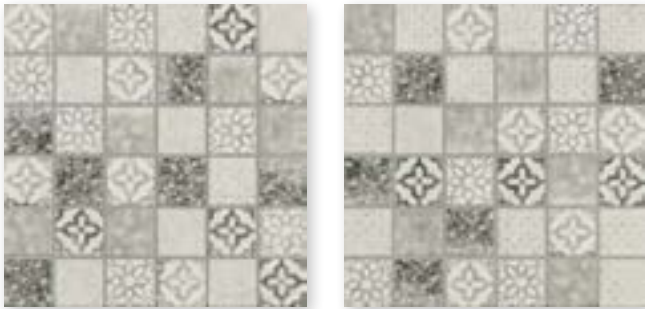

Mosaikbogen Vola 30 x 30 cm, grau, eben, R10/B



Mosaikbogen Ornamenta 30 x 30 cm, blue, eben



Mosaikbogen Ornamenta 30 x 30 cm, multicolor, eben

Die Dekorationen Ornamenta sind farblich abgestimmt auf die Dekorfliesen der Serie Trio: Color und Lines (siehe Seite 472 ff).



Rückseitig thermoplastisch verklebte Mosaik von Agrob Buchtal sind nicht nur im Trockenbereich, sondern auch bedenkenlos im Unterwasserbereich (z. B. Schwimmbecken/ Whirlpool) sowie im dauernassbelasteten Bereich einsetzbar.

Die Artikel Vola und Ornamenta bestehen jeweils aus unterschiedlichen Motiven. Die Anordnung und Konfektionierung erfolgt zufällig und willkürlich.

Mosaik 10 x 10 cm



Mosaikbogen Vola 30 x 30 cm, mehrfarbig, eben



Mosaikbogen Mesh 30 x 30 cm, Natur-mix, eben



Mosaikbogen 30 x 30 cm
weiß, eben



Mosaikbogen 30 x 30 cm
beige, eben



Mosaikbogen 30 x 30 cm
grau, eben



Rückseitig thermoplastisch verklebte Mosaike von Agrob Buchtal sind nicht nur im Trockenbereich, sondern auch bedenkenlos im Unterwasserbereich (z. B. Schwimmbecken/ Whirlpool) sowie im dauernassbelasteten Bereich einsetzbar.



Wand-/Bodenfliese Ornamenta 15 x 15 cm, blue, eben



Wand-/Bodenfliese Ornamenta 15 x 15 cm, multicolor, eben

Die Dekorationen Ornamenta sind farblich abgestimmt auf die Dekorfliesen der Serie Trio: Color und Lines (siehe Seite 472 ff).

Die Artikel Vola, Mesh und Ornamenta bestehen jeweils aus unterschiedlichen Motiven. Die Anordnung und Konfektionierung erfolgt zufällig und willkürlich.



Wand-/Bodenfliese Vola 20 x 20 cm, mehrfarbig, eben



Wand-/Bodenfliese Vola 20 x 20 cm, grau, eben

Die Artikel Vola und Salina bestehen jeweils aus unterschiedlichen Motiven. Die Anordnung und Konfektionierung erfolgt zufällig und willkürlich.



Wand-/Bodenfliese Salina 20 x 20 cm, mehrfarbig, eben



Einzelmotiv Nelas 20 x 20 cm, schwarz-weiß, eben



Einzelmotiv Mellby 20 x 20 cm, grau, eben



Wand-/Bodenfliese 20 x 20 cm, weiß, eben



Wand-/Bodenfliese 20 x 20 cm, beige, eben



Wand-/Bodenfliese 20 x 20 cm, grau, eben



Wand-/Bodenfliese 20 x 20 cm, anthrazit, eben



Wand-/Bodenfliese
20 x 20 cm, cementgrau,
strukturiert, R10/B



Wand-/Bodenfliese Vanda 20 x 20 cm, mehrfarbig, eben, R10/B

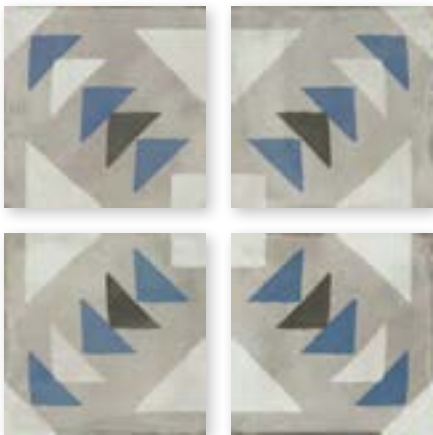

Einzelmotiv Baleno 20 x 20 cm, mehrfarbig, eben, R10/B

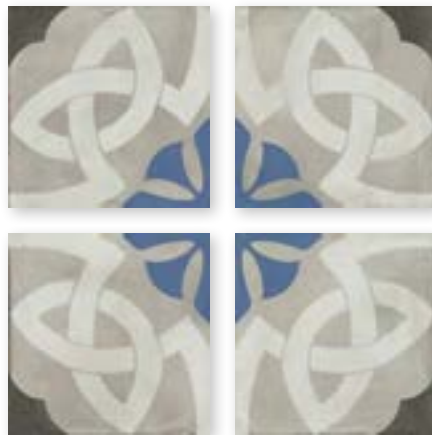

Einzelmotiv Isola 20 x 20 cm, mehrfarbig, eben, R10/B

Der Artikel Vanda besteht aus unterschiedlichen Motiven. Die Anordnung und Konfektionierung erfolgt zufällig und willkürlich.

Mosaik

2,5 x 2,5 cm

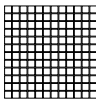

5 x 5 cm

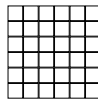

5 x 5 cmw

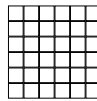

10 x 10 cm

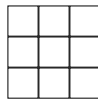

10 x 10 cm

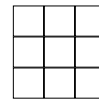

10 x 10 cm

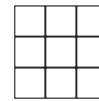

Vola
Bogen: 297 x 297 mm

Vola
Bogen: 297 x 297 mm

Ornamenta
Bogen: 297 x 297 mm

Vola
Bogen: 297 x 297 mm

Mesh
Bogen: 297 x 297 mm

Bogen: 297 x 297 mm



	2,5 x 2,5 / 1 x 1	5 x 5 / 2 x 2	5 x 5 cm / 2 x 2	10 x 10 / 4 x 4	10 x 10 / 4 x 4	10 x 10 / 4 x 4	Beanspruchungsgruppe
	23 x 23 x 6,5 mm	47 x 47 x 6,5 mm	47 x 47 x 6,5 mm	97 x 97 x 6,5 mm	97 x 97 x 6,5 mm	97 x 97 x 6,5 mm	Nennmaß - cm/in
	eben, seidenmatt	eben, seidenmatt	eben, matt	eben, seidenmatt	eben, seidenmatt	eben, seidenmatt	Herstellmaß
	11 Bögen	11 Bögen	11,000	11 Bögen	11 Bögen	11 Bögen	Oberfläche
	12,100	12,331	12,331	13,101	13,101	13,101	m ² - Stück
	11 Bögen	11 Bögen	11 Bögen	11 Bögen	11 Bögen	11 Bögen	m ² - kg
	1,000	1,000	1,000	1,000	1,000	1,000	Paket - Stück
	12,100	12,331	12,331	13,101	13,101	13,101	Paket - m ²
	48,000	64,000	64,000	64,000	64,000	64,000	Paket - kg
	580,800	789,184	789,184	838,464	838,464	838,464	Palette - m ²
	Bib	Bib	Bib	Bib	Bib	Bib	Palette - kg
		R10/B					Produktnorm
	1	1	1	1	1	1	Trittsicherheit
							Belastung
	42400H	42500H		42020H			4
	Preisgr. W303 (St.)	Preisgr. W171 (m ²)		Preisgr. W150 (m ²)			mehrfarbig <input type="checkbox"/> V4
	42401H						3
	Preisgr. W303 (St.)						beige-braun <input type="checkbox"/> V4
	42402H	42501H					4
	Preisgr. W303 (St.)	Preisgr. W171 (m ²)					grau <input type="checkbox"/> V4
			42502H				3
			Preisgr. W171 (m ²)				blue <input type="checkbox"/> V2
			42503H				3
			Preisgr. W171 (m ²)				Multicolor <input type="checkbox"/> V3
					42010H		4
					Preisgr. W150 (m ²)		Natur-mix <input type="checkbox"/> V4
						42000H	4
						Preisgr. W117 (m ²)	weiß <input type="checkbox"/> V1
						42001H	4
						Preisgr. W117 (m ²)	beige <input type="checkbox"/> V1
						42002H	4
						Preisgr. W117 (m ²)	grau <input type="checkbox"/> V1

Die Artikel Vola, Mesh und Ornamenta bestehen jeweils aus unterschiedlichen Motiven.
Die Anordnung und Konfektionierung erfolgt zufällig und willkürlich.



Wand- und Bodenfliesen

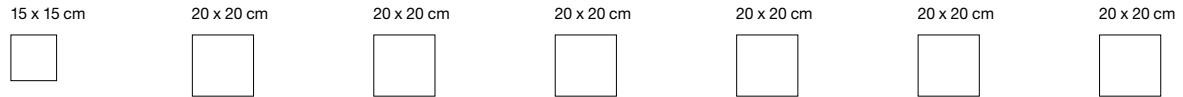

	<i>Ornamenta</i>	<i>Vola</i>	<i>Salina</i>	<i>Einzelmotiv Nelas</i>	<i>Einzelmotiv Mellby</i>
Nennmaß - cm/in	15 x 15 / 6 x 6	20 x 20 / 8 x 8	20 x 20 / 8 x 8	20 x 20 / 8 x 8	20 x 20 / 8 x 8
Herstellmaß	147 x 147 x 6,5 mm	197 x 197 x 6,5 mm	197 x 197 x 6,5 mm	197 x 197 x 6,5 mm	197 x 197 x 6,5 mm
Oberfläche	eben, matt	eben, seidenmatt	strukturiert, matt	eben, seidenmatt	eben, seidenmatt
m ² - Stück	44,444	25	25	25	25
m ² - kg	13,955	13,875	13,875	13,875	13,875
Paket - Stück	44	25	25	25	25
Paket - m ²	0,990	1,000	1,000	1,000	1,000
Paket - kg	13,816	13,875	13,875	13,875	13,875
Palette - m ²	79,201	72,000	72,000	72,000	72,000
Palette - kg	1.105,280	999,000	999,000	999,000	999,000
Produktnorm	Bib	Bib	Bla	Bib	Bib
Trittsicherheit			R10/B		
Belastung	1	1	1	1	1
Beanspruchungsgruppe	4	4	4	4	4
weiß <input type="checkbox"/> V1		42100H Preisgr. W117 (m ²)			
beige <input type="checkbox"/> V1		42101H Preisgr. W117 (m ²)			
grau <input type="checkbox"/> V1		42102H Preisgr. W117 (m ²)			
anthrazit <input type="checkbox"/> V1		42103H Preisgr. W117 (m ²)			
cementgrau <input type="checkbox"/> V4		44425H Preisgr. W117 (m ²)			
mehrfarbig <input type="checkbox"/> V4			42120H Preisgr. W150 (m ²)	42130H Preisgr. W150 (m ²)	
schwarz-weiß <input type="checkbox"/> V4				44400H Preisgr. W150 (m ²)	
grau <input type="checkbox"/> V4			42121H Preisgr. W150 (m ²)		44401H Preisgr. W150 (m ²)
blue <input type="checkbox"/> V3	44500H Preisgr. W111 (m ²)				
multicolor <input type="checkbox"/> V4	44501H Preisgr. W111 (m ²)				



Die Artikel Vola, Ornamenta und Salina bestehen jeweils aus unterschiedlichen Motiven.
Die Anordnung und Konfektionierung erfolgt zufällig und willkürlich.

Wand- und Bodenfliesen

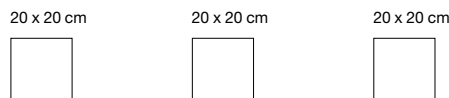

	<i>Einzelmotiv Baleno</i>	<i>Einzelmotiv Isola</i>	<i>Vanda</i>
Nennmaß - cm/in	20 x 20 / 8 x 8	20 x 20 / 8 x 8	20 x 20 / 8 x 8
Herstellmaß	197 x 197 x 6,5 mm	197 x 197 x 6,5 mm	197 x 197 x 6,5 mm
Oberfläche	strukturiert, matt	strukturiert, matt	strukturiert, matt
m ² - Stück	25	25	25
m ² - kg	13,875	13,875	13,875
Paket - Stück	25	25	25
Paket - m ²	1,000	1,000	1,000
Paket - kg	13,875	13,875	13,875
Palette - m ²	72,000	72,000	72,000
Palette - kg	999,000	999,000	999,000
Produktnorm	Bla	Bla	Bla
Trittsicherheit	R10/B	R10/B	R10/B
Belastung	1	1	1
mehrfarbig <input type="checkbox"/> V4	44447H Preisgr. W150 (m ²)	44448H Preisgr. W150 (m ²)	44449H Preisgr. W150 (m ²)



Der Artikel Vanda besteht aus unterschiedlichen Motiven.
Die Anordnung und Konfektionierung erfolgt zufällig und willkürlich.

Rendering







Ein Zitat aus der Natur

Für Liebhaber von natürlicher Optik: Die markant strukturierte Oberfläche der Serie Pizarro erinnert an Schiefergestein – keramisch umgesetzt. Die Wandfliesen in schlichtem Weiß und zartem Grau sind eine perfekte Wandbekleidung für zeitlose Badezimmer in einem reduzierten Ambiente. Für eine Rhythmisierung oder Akzentuierung der Wandfläche stehen elegante Bordüren mit metallischen Einlegern zur Verfügung.

Rendering



Wandfliese 30 x 60 cm, weiß, strukturiert



Wandfliese 30 x 60 cm, grau, strukturiert

Dekorationselemente



Bordüre 15 x 60 cm, anthrazit, strukturiert



Bordüre 15 x 60 cm, schwarz, strukturiert

Bordüre: Verklebung rückseitig auf Glasfasernetz,
Bogen: 147 x 597 mm

Wandfliesen³ Dekorations-
elemente^{1/2/4/5}

30 x 60 cm

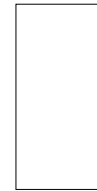

15 x 60 cm



Bordüre
Bogen: 147 x 597 mm

				30 x 60 / 12 x 24	15 x 60 / 6 x 24	Nennmaß - cm/in
				297 x 597 x 9 mm	147 x 597 x 10,5 mm	Herstellmaß
				strukturiert, seidenmatt	strukturiert, matt	Oberfläche
				5,556/m ²	1,667/m	m ² /m - Stück
				14,946/m ²	3,584/m	m ² /m - kg
				9	1	Paket - Stück
				1,620 m ²	0,600 m	Paket - m ² /m
				24,210	2,150	Paket - kg
				77,754		Palette - m ²
				1.162,080		Palette - kg
				BIII	Bla	Produktnorm
				281476		weiß <input type="checkbox"/> V1
				Preisgr. C89 (m ²)		
				281477		grau <input type="checkbox"/> V1
				Preisgr. C89 (m ²)		
					281479	anthrazit <input type="checkbox"/> V2
					Preisgr. C502 (St.)	
					281480	schwarz <input type="checkbox"/> V1
					Preisgr. C502 (St.)	



³ nicht frostsicher

⁴ Abgabe der Dekorationselemente ausschließlich in vollen Kartons.

⁵ Nur für die Verlegung an der Wand geeignet



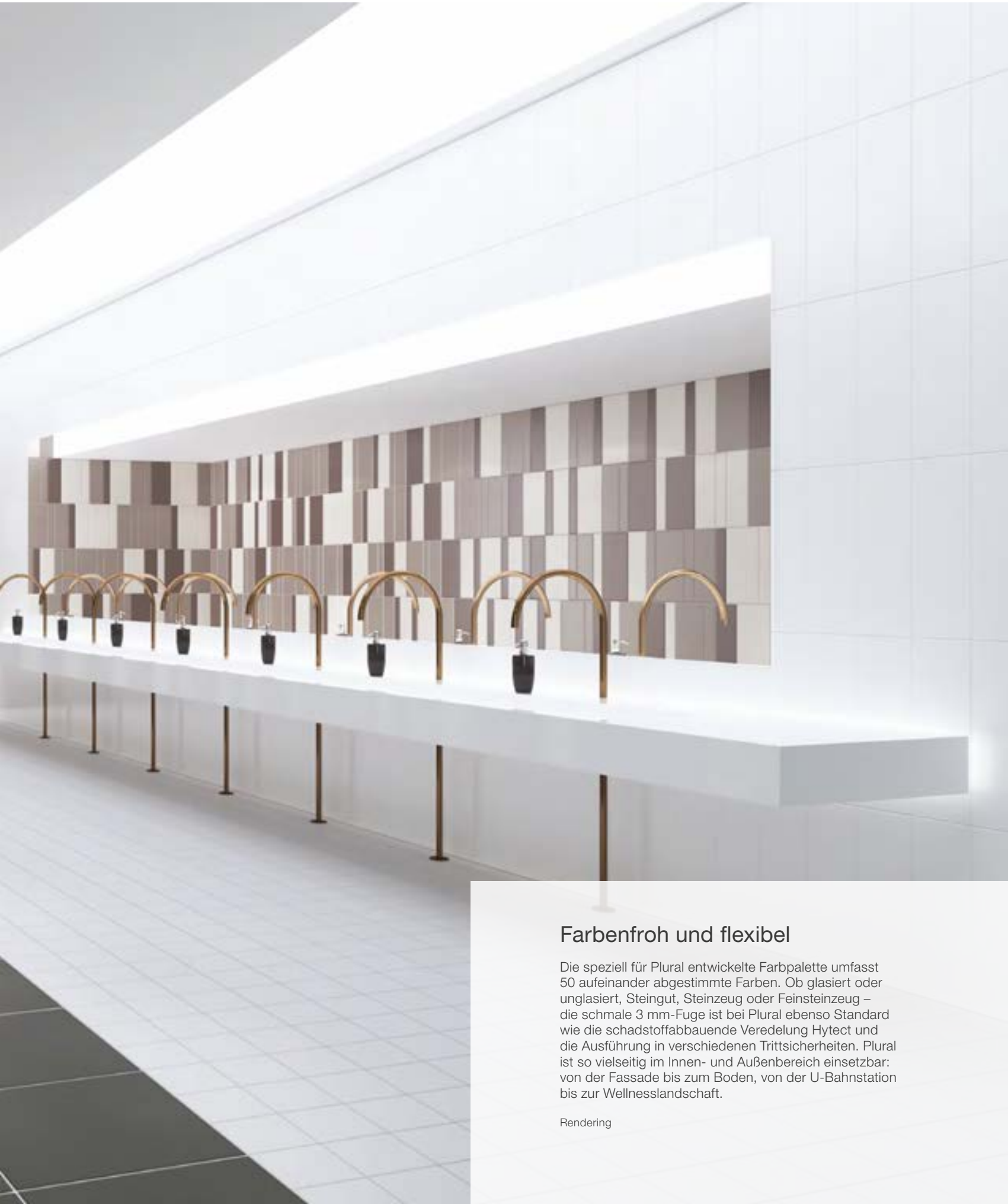

Farbenfroh und flexibel

Die speziell für Plural entwickelte Farbpalette umfasst 50 aufeinander abgestimmte Farben. Ob glasiert oder unglasiert, Steingut, Steinzeug oder Feinsteinzeug – die schmale 3 mm-Fuge ist bei Plural ebenso Standard wie die schadstoffabbauende Veredelung Hytect und die Ausführung in verschiedenen Trittsicherheiten. Plural ist so vielseitig im Innen- und Außenbereich einsetzbar: von der Fassade bis zum Boden, von der U-Bahnstation bis zur Wellnesslandschaft.

Rendering

FARBSYSTEM UNICOLOR – Vom Farb- zum Möglichkeitsraum



Intensivfarben



ocker aktiv NCS S 3050-Y40R	lachs aktiv NCS S 4040-Y70R	oxidrot aktiv NCS S 4050-Y90R	steingrau aktiv NCS S 5030-Y90R	sandgrau aktiv NCS S 7010-Y90R
ocker hell NCS S 2030-Y20R	lachs hell NCS S 1515-Y50R	oxidrot hell NCS S 2010-Y80R	steingrau hell NCS S 2502-R	sandgrau hell NCS S 1502-Y
ocker mittel NCS S 3030-Y30R	lachs mittel NCS S 2020-Y50R	oxidrot mittel NCS S 3020-Y80R	steingrau mittel NCS S 3502-R oder RAL 7036	sandgrau mittel NCS S 3005-Y50R
ocker dunkel NCS S 4030-Y50R	lachs dunkel NCS S 3040-Y60R	oxidrot dunkel NCS S 5020-Y80R	steingrau dunkel NCS S 6005-Y80R	sandgrau dunkel NCS S 6010-Y50R
ocker	lachs	oxidrot	steingrau	sandgrau
neutral 5 (basaltgrau) NCS S 5502-B oder RAL 7046	neutral 4 (graphitschwarz) NCS S 6000-N oder RAL 7037	neutral 3 (asphaltschwarz) NCS S 6500-N	neutral 2 (anthrazit) NCS S 7500-N oder RAL 7015	neutral 1 (tiefschwarz) NCS S 9000-N oder RAL 9017



seegrün
NCS S4030-G
oder RAL-Design
6000



blaugrün
NCS S3040-B50G
oder RAL-Design
190 50 25



kobaltblau
NCS S4055-R70B
oder RAL-Design
290 30 40

Intensivfarben



1120/1121
neutral 10 (aktivweiß)

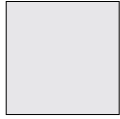

1119
neutral 9 (weißgrau)



1118
neutral 8 (lichtgrau)



1117
neutral 7 (kieselgrau)



1115
neutral 5 (basaltgrau)



1113
neutral 3 (asphaltschwarz)



1112
neutral 2 (anthrazit)



1111
neutral 1 (tiefschwarz)



1004
azur dunkel



1003
azur mittel



1002
azur hell



1001
azur aktiv



1050
kobaltblau



1008
blau dunkel



1007
blau mittel



1006
blau hell



1005
blau aktiv



1049
blaugrün



1012
türkis dunkel



1011
türkis mittel



1010
türkis hell



1009
türkis aktiv



1048
seegrün



1016
grün dunkel



1015
grün mittel



1014
grün hell



1013
grün aktiv



1047
gelbgrün



1020
gelb dunkel



1019
gelb mittel



1018
gelb hell



1017
gelb aktiv



1046
sonnengelb



1024
ocker dunkel



1023
ocker mittel



1022
ocker hell



1021
ocker aktiv



1045
signalorange



1028
lachs dunkel



1027
lachs mittel



1026
lachs hell



1025
lachs aktiv



1044
feuerrot



1032
oxidrot dunkel



1031
oxidrot mittel



1030
oxidrot hell



1029
oxidrot aktiv



1043
braunrot



1036
steingrau dunkel



1035
steingrau mittel



1034
steingrau hell



1033
steingrau aktiv



1042
beerenrot



1040
sandgrau dunkel



1039
sandgrau mittel



1038
sandgrau hell



1037
sandgrau aktiv



1041
violett

Formate Steingut



Wandfliese 15 x 30 cm, eben



Wandfliese 20 x 40 cm, eben

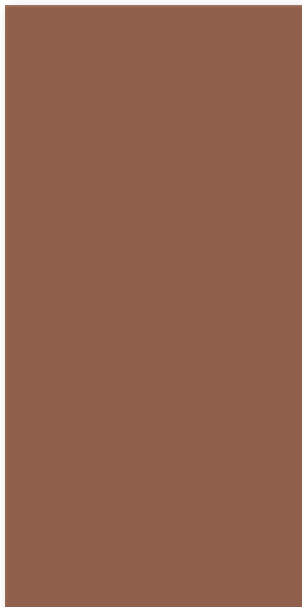

Wandfliese 30 x 60 cm, eben

Wandfliesen³

15 x 30 cm²



20 x 40 cm²

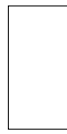

30 x 60 cm



Nennmaß - cm/in	15 x 30 / 6 x 12	20 x 40 / 8 x 16	30 x 60 / 12 x 24			
Herstellmaß	147 x 297 x 6,5 mm	197 x 397 x 7,5 mm	297 x 597 x 9 mm			
Oberfläche	eben, seidenmatt	eben, seidenmatt	eben, seidenmatt			
m ² - Stück	22,222	12,500	5,556			
m ² - kg	10,622	12,975	14,946			
Paket - Stück	24	16	9			
Paket - m ²	1,080	1,280	1,620			
Paket - kg	11,472	16,608	24,210			
Palette - m ²	91,801	92,160	77,754			
Palette - kg	975,120	1.195,776	1.162,080			
Produktnorm	BIII	BIII	BIII			
neutral 10 (aktivweiß glzd.)	130-1121H Preisgr. A100 (m ²)	240-1121H Preisgr. A100 (m ²)	360-1121H Preisgr. A88 (m ²)			
neutral 10 (aktivweiß)	130-1120H Preisgr. A100 (m ²)	240-1120H Preisgr. A100 (m ²)	360-1120H Preisgr. A88 (m ²)			
neutral 9 (weißgrau)	130-1119H Preisgr. A121 (m ²)	240-1119H Preisgr. A121 (m ²)	360-1119H Preisgr. A109 (m ²)			
neutral 8 (lichtgrau)	130-1118H¹ Preisgr. A148 (m ²)	240-1118H¹ Preisgr. A148 (m ²)	360-1118H Preisgr. A109 (m ²)			
neutral 7 (kieselgrau)	130-1117H Preisgr. A121 (m ²)	240-1117H Preisgr. A121 (m ²)	360-1117H Preisgr. A109 (m ²)			
neutral 5 (basaltgrau)	130-1115H Preisgr. A121 (m ²)	240-1115H Preisgr. A121 (m ²)	360-1115H Preisgr. A109 (m ²)			
neutral 3 (asphaltschwarz)	130-1113H Preisgr. A121 (m ²)	240-1113H Preisgr. A121 (m ²)	360-1113H Preisgr. A109 (m ²)			
neutral 2 (anthrazit)	130-1112H¹ Preisgr. A121 (m ²)	240-1112H¹ Preisgr. A148 (m ²)	360-1112H¹ Preisgr. A136 (m ²)			
neutral 1 (tiefschwarz)	130-1111H Preisgr. A121 (m ²)	240-1111H Preisgr. A121 (m ²)	360-1111H Preisgr. A109 (m ²)			
azur aktiv	130-1001H¹ Preisgr. A148 (m ²)	240-1001H¹ Preisgr. A148 (m ²)	360-1001H¹ Preisgr. A136 (m ²)			
azur hell	130-1002H¹ Preisgr. A148 (m ²)	240-1002H Preisgr. A121 (m ²)	360-1002H¹ Preisgr. A136 (m ²)			
azur mittel	130-1003H¹ Preisgr. A148 (m ²)	240-1003H¹ Preisgr. A148 (m ²)	360-1003H¹ Preisgr. A136 (m ²)			
azur dunkel	130-1004H Preisgr. A121 (m ²)	240-1004H Preisgr. A121 (m ²)	360-1004H Preisgr. A109 (m ²)			
blau aktiv	130-1005H¹ Preisgr. A148 (m ²)	240-1005H¹ Preisgr. A148 (m ²)	360-1005H¹ Preisgr. A136 (m ²)			
blau hell	130-1006H¹ Preisgr. A148 (m ²)	240-1006H Preisgr. A121 (m ²)	360-1006H¹ Preisgr. A136 (m ²)			
blau mittel	130-1007H¹ Preisgr. A148 (m ²)	240-1007H¹ Preisgr. A148 (m ²)	360-1007H¹ Preisgr. A136 (m ²)			
blau dunkel	130-1008H Preisgr. A121 (m ²)	240-1008H Preisgr. A121 (m ²)	360-1008H Preisgr. A109 (m ²)			
türkis aktiv	130-1009H¹ Preisgr. A148 (m ²)	240-1009H¹ Preisgr. A148 (m ²)	360-1009H¹ Preisgr. A136 (m ²)			
türkis hell	130-1010H¹ Preisgr. A148 (m ²)	240-1010H Preisgr. A121 (m ²)	360-1010H¹ Preisgr. A136 (m ²)			
türkis mittel	130-1011H¹ Preisgr. A148 (m ²)	240-1011H¹ Preisgr. A148 (m ²)	360-1011H¹ Preisgr. A136 (m ²)			
türkis dunkel	130-1012H Preisgr. A121 (m ²)	240-1012H Preisgr. A121 (m ²)	360-1012H Preisgr. A109 (m ²)			
grün aktiv	130-1013H¹ Preisgr. A148 (m ²)	240-1013H¹ Preisgr. A148 (m ²)	360-1013H¹ Preisgr. A136 (m ²)			
grün hell	130-1014H¹ Preisgr. A148 (m ²)	240-1014H Preisgr. A121 (m ²)	360-1014H¹ Preisgr. A136 (m ²)			
grün mittel	130-1015H¹ Preisgr. A148 (m ²)	240-1015H¹ Preisgr. A148 (m ²)	360-1015H¹ Preisgr. A136 (m ²)			
grün dunkel	130-1016H Preisgr. A121 (m ²)	240-1016H Preisgr. A121 (m ²)	360-1016H Preisgr. A109 (m ²)			



² Eine überglasierte Kopfkante 10 % pro Lieferung. Kanten jeweils zu 2/3 überglasiert.

³ OP-Eignung auf Anfrage.

Wandfliesen³

15 x 30 cm²



20 x 40 cm²



30 x 60 cm



	15 x 30 / 6 x 12	20 x 40 / 8 x 16	30 x 60 / 12 x 24	Nennmaß - cm/in
	147 x 297 x 6,5 mm	197 x 397 x 7,5 mm	297 x 597 x 9 mm	Herstellmaß
	eben, seidenmatt	eben, seidenmatt	eben, seidenmatt	Oberfläche
	22,222	12,500	5,556	m ² - Stück
	10,622	12,975	14,946	m ² - kg
	24	16	9	Paket - Stück
	1,080	1,280	1,620	Paket - m ²
	11,472	16,608	24,210	Paket - kg
	91,801	92,160	77,754	Palette - m ²
	975,120	1.195,776	1.162,080	Palette - kg
	BIII	BIII	BIII	Produktnorm
	130-1017H ¹	240-1017H ¹	360-1017H ¹	gelb aktiv <input type="checkbox"/>
	Preisgr. A148 (m ²)	Preisgr. A148 (m ²)	Preisgr. A136 (m ²)	
	130-1018H ¹	240-1018H	360-1018H ¹	gelb hell <input type="checkbox"/>
	Preisgr. A148 (m ²)	Preisgr. A121 (m ²)	Preisgr. A136 (m ²)	
	130-1019H ¹	240-1019H ¹	360-1019H ¹	gelb mittel <input type="checkbox"/>
	Preisgr. A148 (m ²)	Preisgr. A148 (m ²)	Preisgr. A136 (m ²)	
	130-1020H	240-1020H	360-1020H	gelb dunkel <input type="checkbox"/>
	Preisgr. A121 (m ²)	Preisgr. A121 (m ²)	Preisgr. A109 (m ²)	
	130-1021H ¹	240-1021H ¹	360-1021H ¹	ocker aktiv <input type="checkbox"/>
	Preisgr. A148 (m ²)	Preisgr. A148 (m ²)	Preisgr. A136 (m ²)	
	130-1022H ¹	240-1022H	360-1022H ¹	ocker hell <input type="checkbox"/>
	Preisgr. A148 (m ²)	Preisgr. A121 (m ²)	Preisgr. A136 (m ²)	
	130-1023H ¹	240-1023H ¹	360-1023H ¹	ocker mittel <input type="checkbox"/>
	Preisgr. A148 (m ²)	Preisgr. A148 (m ²)	Preisgr. A136 (m ²)	
	130-1024H	240-1024H	360-1024H	ocker dunkel <input type="checkbox"/>
	Preisgr. A121 (m ²)	Preisgr. A121 (m ²)	Preisgr. A109 (m ²)	
	130-1025H ¹	240-1025H ¹	360-1025H ¹	lachs aktiv <input type="checkbox"/>
	Preisgr. A148 (m ²)	Preisgr. A148 (m ²)	Preisgr. A136 (m ²)	
	130-1026H ¹	240-1026H	360-1026H ¹	lachs hell <input type="checkbox"/>
	Preisgr. A148 (m ²)	Preisgr. A121 (m ²)	Preisgr. A136 (m ²)	
	130-1027H ¹	240-1027H ¹	360-1027H ¹	lachs mittel <input type="checkbox"/>
	Preisgr. A148 (m ²)	Preisgr. A148 (m ²)	Preisgr. A136 (m ²)	
	130-1028H	240-1028H	360-1028H	lachs dunkel <input type="checkbox"/>
	Preisgr. A121 (m ²)	Preisgr. A121 (m ²)	Preisgr. A109 (m ²)	
	130-1029H ¹	240-1029H ¹	360-1029H ¹	oxidrot aktiv <input type="checkbox"/>
	Preisgr. A148 (m ²)	Preisgr. A148 (m ²)	Preisgr. A136 (m ²)	
	130-1030H ¹	240-1030H	360-1030H ¹	oxidrot hell <input type="checkbox"/>
	Preisgr. A148 (m ²)	Preisgr. A121 (m ²)	Preisgr. A136 (m ²)	
	130-1031H ¹	240-1031H ¹	360-1031H ¹	oxidrot mittel <input type="checkbox"/>
	Preisgr. A148 (m ²)	Preisgr. A148 (m ²)	Preisgr. A136 (m ²)	
	130-1032H	240-1032H	360-1032H	oxidrot dunkel <input type="checkbox"/>
	Preisgr. A121 (m ²)	Preisgr. A121 (m ²)	Preisgr. A109 (m ²)	
	130-1033H ¹	240-1033H ¹	360-1033H ¹	steingrau aktiv <input type="checkbox"/>
	Preisgr. A148 (m ²)	Preisgr. A148 (m ²)	Preisgr. A136 (m ²)	
	130-1034H ¹	240-1034H	360-1034H ¹	steingrau hell <input type="checkbox"/>
	Preisgr. A148 (m ²)	Preisgr. A121 (m ²)	Preisgr. A136 (m ²)	
	130-1035H ¹	240-1035H ¹	360-1035H ¹	steingrau mittel <input type="checkbox"/>
	Preisgr. A148 (m ²)	Preisgr. A148 (m ²)	Preisgr. A136 (m ²)	
	130-1036H	240-1036H	360-1036H	steingrau dunkel <input type="checkbox"/>
	Preisgr. A121 (m ²)	Preisgr. A121 (m ²)	Preisgr. A109 (m ²)	
	130-1037H ¹	240-1037H ¹	360-1037H ¹	sandgrau aktiv <input type="checkbox"/>
	Preisgr. A148 (m ²)	Preisgr. A148 (m ²)	Preisgr. A136 (m ²)	
	130-1038H	240-1038H	360-1038H	sandgrau hell <input type="checkbox"/>
	Preisgr. A121 (m ²)	Preisgr. A121 (m ²)	Preisgr. A109 (m ²)	
	130-1039H	240-1039H ¹	360-1039H ¹	sandgrau mittel <input type="checkbox"/>
	Preisgr. A121 (m ²)	Preisgr. A148 (m ²)	Preisgr. A136 (m ²)	
	130-1040H	240-1040H	360-1040H	sandgrau dunkel <input type="checkbox"/>
	Preisgr. A121 (m ²)	Preisgr. A121 (m ²)	Preisgr. A109 (m ²)	



² Eine überglaste Kopfkante 10 % pro Lieferung. Kanten jeweils zu 2/3 überglast.

³ OP-Eignung auf Anfrage.

Wandfliesen¹ **NEU**

15 x 30 cm



30 x 60 cm

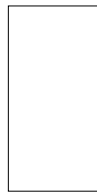

Nennmaß - cm/in	15 x 30 / 6 x 12	30 x 60 / 12 x 24				
Herstellmaß	147 x 297 x 6,5 mm	297 x 597 x 9 mm				
Oberfläche	eben, seidenmatt	eben, seidenmatt				
m ² - Stück	22,222	5,556				
m ² - kg	10,622	14,946				
Paket - Stück	24	9				
Paket - m ²	1,080	1,620				
Paket - kg	11,472	24,210				
Palette - m ²	91,801	77,754				
Palette - kg	975,120	1.162,080				
Produktnorm	BIII	BIII				
violett <input type="checkbox"/>	<i>130-1041H</i> Preisgr. A148 (m ²)	<i>360-1041H</i> Preisgr. A148 (m ²)				
beerenrot <input type="checkbox"/>	<i>130-1042H</i> Preisgr. A148 (m ²)	<i>360-1042H</i> Preisgr. A148 (m ²)				
braunrot <input type="checkbox"/>	<i>130-1043H</i> Preisgr. A148 (m ²)	<i>360-1043H</i> Preisgr. A148 (m ²)				
feuerrot <input type="checkbox"/>	<i>130-1044H</i> Preisgr. A148 (m ²)	<i>360-1044H</i> Preisgr. A148 (m ²)				
signalorange <input type="checkbox"/>	<i>130-1045H</i> Preisgr. A148 (m ²)	<i>360-1045H</i> Preisgr. A148 (m ²)				
sonnengelb <input type="checkbox"/>	<i>130-1046H</i> Preisgr. A148 (m ²)	<i>360-1046H</i> Preisgr. A148 (m ²)				
gelbgrün <input type="checkbox"/>	<i>130-1047H</i> Preisgr. A148 (m ²)	<i>360-1047H</i> Preisgr. A148 (m ²)				
seegrün <input type="checkbox"/>	<i>130-1048H</i> Preisgr. A148 (m ²)	<i>360-1048H</i> Preisgr. A148 (m ²)				
blaugrün <input type="checkbox"/>	<i>130-1049H</i> Preisgr. A148 (m ²)	<i>360-1049H</i> Preisgr. A148 (m ²)				
kobaltblau <input type="checkbox"/>	<i>130-1050H</i> Preisgr. A148 (m ²)	<i>360-1050H</i> Preisgr. A148 (m ²)				





Intensivfarben



2120/2121/700/701
neutral 10 (aktivweiß)



2119/552119
neutral 9 (weißgrau)



2118/552118
neutral 8 (lichtgrau)



2117/552117
neutral 7 (kieselgrau)



2116/552116
neutral 6 (perigräu)



2115/552115
neutral 5 (basaltgräu)



2114/552114
neutral 4 (graphitschwarz)



2113/552113
neutral 3 (asphaltschwarz)



2112/552112
neutral 2 (anthrazit)



2111/5716
neutral 1 (tiefschwarz)



2004/552004
azur dunkel



2003/552003
azur mittel



2002/552002
azur hell



2008/552008
blau dunkel



2007/552007
blau mittel

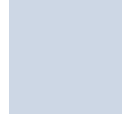

2006/552006
blau hell



2012/552012
türkis dunkel



2011/552011
türkis mittel



2010/552010
türkis hell



2016/552016
grün dunkel



2015/552015
grün mittel



2014/552014
grün hell



2020/552020
gelb dunkel



2019/552019
gelb mittel



2018/552018
gelb hell



2024/552024
ocker dunkel



2023/552023
ocker mittel



2022/552022
ocker hell



2028/552028
lachs dunkel



2027/552027
lachs mittel



2026/552026
lachs hell



2032/552032
oxidrot dunkel



2031/552031
oxidrot mittel



2030/552030
oxidrot hell



2036/552036
steingrau dunkel



2035/552035
steingrau mittel



2034/552034
steingrau hell



2040/552040
sandgrau dunkel



2039/552039
sandgrau mittel



2038/552038
sandgrau hell



2001/552001
azur aktiv



2005/552005
blau aktiv



2009/552009
türkis aktiv



2013/552013
grün aktiv



2017/552017
gelb aktiv



2021/552021
ocker aktiv



2025/552025
lachs aktiv



2029/552029
oxidrot aktiv



2033/552033
steingrau aktiv



2037/552037
sandgrau aktiv



2050
kobaltblau



2049
blaugrün



2048
seegrün



2047
gelbgrün



2046
sonnengelb



2045
signalorange



2044
feuerrot



2043
braunrot



2042
beerenrot



2041
violett

Formate Steinzeug

Mosaik 2,5 x 2,5 cm

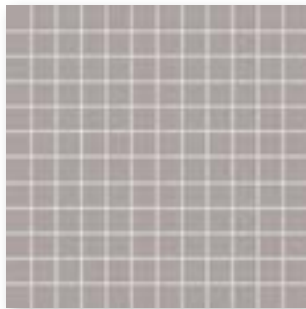

Mosaikbogen 30 x 30 cm, eben

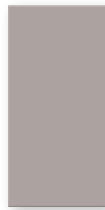

Boden-/Wandfliese
10 x 20 cm, eben

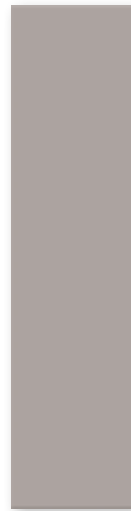

Boden-/Wandfliese
12,5 x 50 cm, eben

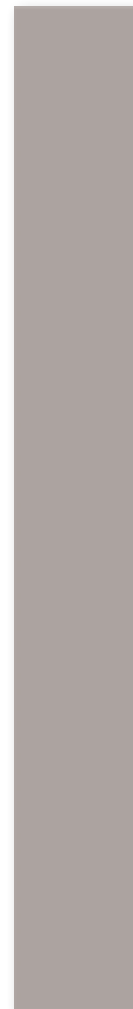

Boden-/Wandfliese
12,5 x 100 cm, eben

Mosaik 5 x 5 cm

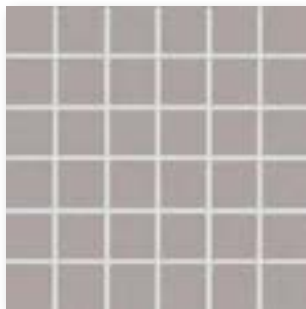

Mosaikbogen 30 x 30 cm, eben



Boden-/Wandfliese
10 x 30 cm, eben



Boden-/Wandfliese
15 x 15 cm, eben

Mosaik 10 x 10 cm



Mosaikbogen 30 x 30 cm, eben

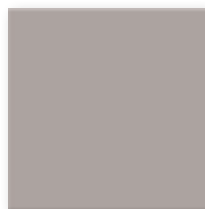

Boden-/Wandfliese
20 x 20 cm, eben



Rückseitig thermoplastisch verklebte Mosaik von Agrob Buchtal sind nicht nur im Trockenbereich, sondern auch bedenkenlos im Unterwasserbereich (z. B. Schwimmbecken/Whirlpool) sowie im dauernassbelasteten Bereich einsetzbar.

Kennen Sie schon unseren Mosaic Designer auf unserer Website www.agrob-buchtal.de? Hier haben Sie die Möglichkeit Ihre individuellen Farbverläufe, Mosaikmischungen und Bildverlegungen zu gestalten.

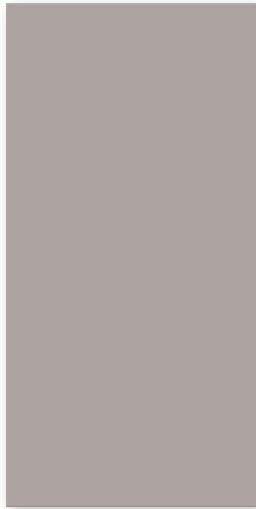

Boden-/Wandfliese
25 x 50 cm, eben



Boden-/Wandfliese
30 x 30 cm, eben



Boden-/Wandfliese
30 x 60 cm, eben

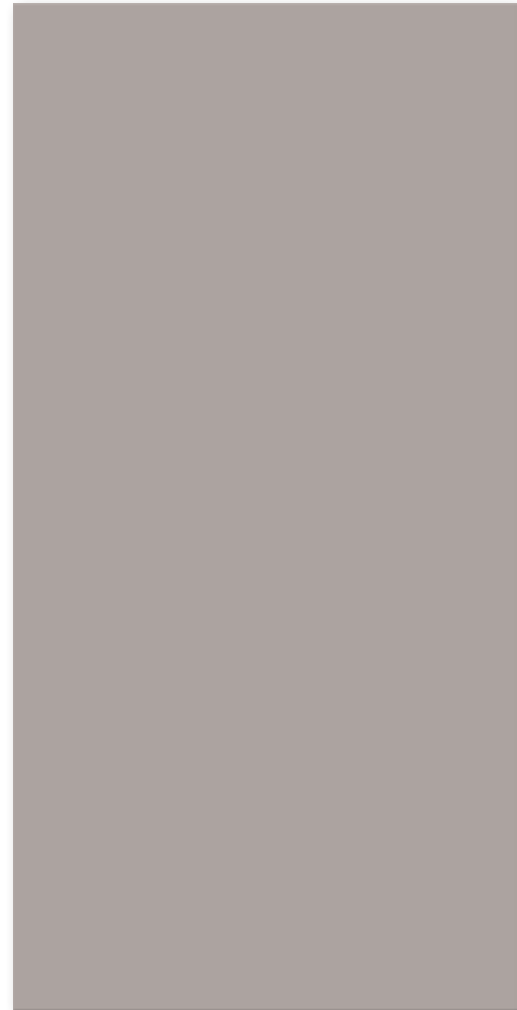

Boden-/Wandfliese
50 x 100 cm, eben



Hohlkehlssockel
10 x 10 cm,
eben



Innenecke
eben



Außenecke
eben

Mosaik

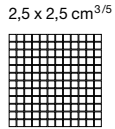

2,5 x 2,5 cm^{3/5}

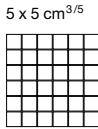

5 x 5 cm^{3/5}

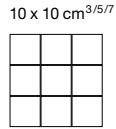

10 x 10 cm^{3/5/7}

Boden-/Wandfliesen

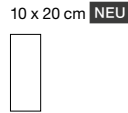

10 x 20 cm **NEU**

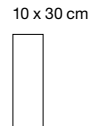

10 x 30 cm

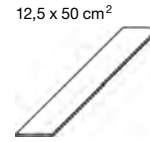

12,5 x 50 cm²

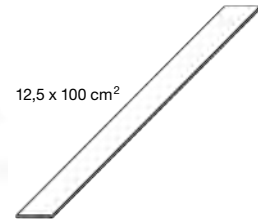

12,5 x 100 cm²



Bogen: 297 x 297 mm

Bogen: 297 x 297 mm

Bogen: 297 x 297 mm

2,5 x 2,5 / 1 x 1	5 x 5 / 2 x 2	10 x 10 / 4 x 4	10 x 20 / 4 x 8	10 x 30 / 4 x 12	12,5 x 50 / 5 x 20	12,5 x 100 / 5 x 40	Beanspruchungsgruppe	Formatnummer
23 x 23 x 6,5 mm eben, OP-geeig.	47 x 47 x 6,5 mm eben, OP-geeig.	97 x 97 x 6,5 mm eben, OP-geeig.	97 x 197 x 6,5 mm eben, OP-geeig.	97 x 297 x 6 mm eben, seidenmatt ⁶	122 x 497 x 8 mm eben, seidenmatt ⁶	122 x 997 x 8 mm eben, seidenmatt ⁶		Nennmaß - cm/in
11 Bögen 12,100	11 Bögen 12,331	11 Bögen 13,101	50,000 13,600	33,333 12,333	16,000 17,040	8,000 17,040		Herstellmaß
11 Bögen 1,000	11 Bögen 1,000	11 Bögen 1,000	33 0,660	38 1,140	8 0,500	10 1,250	m ² - Stück	m ² - kg
12,100	12,331	13,101	8,976	14,060	8,520	21,300	Paket - Stück	Paket - m ²
48,000	64,000	64,000	59,400	95,761	55,000	67,500	Paket - kg	Palette - m ²
580,800	789,184	838,464	807,840	1.181,040	937,200	1.150,200	Palette - kg	Produktnorm
Blb 1	Blb 1	Blb 1	Blb 1	Alb 1	Alb 1	Alb 1	Belastung	
702-2120H Preisgr. A229 (m ²) 702-2119H ¹ Preisgr. A280 (m ²) 702-2118H Preisgr. A229 (m ²) 702-2117H ¹ Preisgr. A280 (m ²) 702-2116H ¹ Preisgr. A280 (m ²) 702-2115H ¹ Preisgr. A280 (m ²) 702-2114H ¹ Preisgr. A280 (m ²) 702-2113H ¹ Preisgr. A280 (m ²) 702-2112H ¹ Preisgr. A280 (m ²) 702-2111H Preisgr. A250 (m ²)	705-2121H Preisgr. A187 (m ²) 705-2120H Preisgr. A187 (m ²) 705-2119H Preisgr. A211 (m ²) 705-2118H Preisgr. A187 (m ²) 705-2117H Preisgr. A211 (m ²) 705-2116H Preisgr. A238 (m ²) 705-2115H Preisgr. A211 (m ²) 705-2114H Preisgr. A211 (m ²) 705-2113H Preisgr. A211 (m ²) 705-2112H Preisgr. A211 (m ²) 705-2111H Preisgr. A211 (m ²) 705-2001H Preisgr. A211 (m ²) 705-2002H Preisgr. A211 (m ²) 705-2003H Preisgr. A211 (m ²) 705-2004H Preisgr. A211 (m ²) 705-2005H Preisgr. A211 (m ²) 705-2006H Preisgr. A211 (m ²) 705-2007H Preisgr. A211 (m ²) 705-2008H Preisgr. A211 (m ²) 705-2009H Preisgr. A211 (m ²) 705-2010H Preisgr. A211 (m ²) 705-2011H Preisgr. A211 (m ²) 705-2012H Preisgr. A211 (m ²) 705-2013H Preisgr. A211 (m ²) 705-2014H Preisgr. A211 (m ²) 705-2015H Preisgr. A211 (m ²) 705-2016H Preisgr. A211 (m ²)	710-2121H Preisgr. A142 (m ²) 710-2120H Preisgr. A142 (m ²) 710-2119H Preisgr. A157 (m ²) 710-2118H Preisgr. A142 (m ²) 710-2117H Preisgr. A157 (m ²) 710-2116H Preisgr. A187 (m ²) 710-2115H Preisgr. A157 (m ²) 710-2114H Preisgr. A157 (m ²) 710-2113H Preisgr. A157 (m ²) 710-2112H Preisgr. A157 (m ²) 710-2111H Preisgr. A157 (m ²) 710-2001H Preisgr. A157 (m ²) 710-2002H Preisgr. A157 (m ²) 710-2003H Preisgr. A157 (m ²) 710-2004H Preisgr. A157 (m ²) 710-2005H Preisgr. A157 (m ²) 710-2006H Preisgr. A157 (m ²) 710-2007H Preisgr. A157 (m ²) 710-2008H Preisgr. A157 (m ²) 710-2009H Preisgr. A157 (m ²) 710-2010H Preisgr. A157 (m ²) 710-2011H Preisgr. A157 (m ²) 710-2012H Preisgr. A157 (m ²) 710-2013H Preisgr. A157 (m ²) 710-2014H Preisgr. A157 (m ²) 710-2015H Preisgr. A157 (m ²) 710-2016H Preisgr. A157 (m ²)	712-2121H Preisgr. A157 (m ²) 712-2120H Preisgr. A157 (m ²) 712-2119H Preisgr. A178 (m ²) 712-2118H ¹ Preisgr. A12 (m ²) 712-2117H Preisgr. A178 (m ²) 712-2116H ¹ Preisgr. A211 (m ²) 712-2115H Preisgr. A178 (m ²) 712-2114H ¹ Preisgr. A211 (m ²) 712-2113H Preisgr. A178 (m ²) 712-2112H ¹ Preisgr. A211 (m ²) 712-2111H Preisgr. A178 (m ²) 712-2001H ¹ Preisgr. A211 (m ²) 712-2002H ¹ Preisgr. A211 (m ²) 712-2003H ¹ Preisgr. A211 (m ²) 712-2004H Preisgr. A178 (m ²) 712-2005H ¹ Preisgr. A211 (m ²) 712-2006H ¹ Preisgr. A211 (m ²) 712-2007H ¹ Preisgr. A211 (m ²) 712-2008H Preisgr. A178 (m ²) 712-2009H ¹ Preisgr. A211 (m ²) 712-2010H ¹ Preisgr. A211 (m ²) 712-2011H ¹ Preisgr. A211 (m ²) 712-2012H Preisgr. A178 (m ²) 712-2013H ¹ Preisgr. A211 (m ²) 712-2014H ¹ Preisgr. A211 (m ²) 712-2015H ¹ Preisgr. A211 (m ²) 712-2016H Preisgr. A178 (m ²)	703 703-2121H Preisgr. A142 (m ²) 703-2120H Preisgr. A142 (m ²) 703-2119H ¹ Preisgr. A187 (m ²) 703-2118H Preisgr. A142 (m ²) 703-2117H ¹ Preisgr. A187 (m ²) 703-2115H ¹ Preisgr. A187 (m ²) 703-2113H Preisgr. A157 (m ²) 703-2112H ¹ Preisgr. A187 (m ²) 703-2111H ⁴ Preisgr. A187 (m ²) 703-2001H Preisgr. A157 (m ²) 703-2002H ¹ Preisgr. A187 (m ²) 703-2003H Preisgr. A157 (m ²) 703-2004H ¹ Preisgr. A187 (m ²) 703-2005H ¹ Preisgr. A187 (m ²) 703-2006H ¹ Preisgr. A187 (m ²) 703-2007H ¹ Preisgr. A187 (m ²) 703-2008H ¹ Preisgr. A187 (m ²) 703-2009H ¹ Preisgr. A187 (m ²) 703-2010H ¹ Preisgr. A187 (m ²) 703-2011H ¹ Preisgr. A187 (m ²) 703-2012H ^{1/4} Preisgr. A187 (m ²) 703-2013H ¹ Preisgr. A187 (m ²) 703-2014H ¹ Preisgr. A187 (m ²) 703-2015H ¹ Preisgr. A187 (m ²) 703-2016H ¹ Preisgr. A187 (m ²)	341550HK 700i-341550HK Preisgr. A211 (m ²) 701i-341550HK Preisgr. A211 (m ²) 552119-341550HK ¹ Preisgr. A259 (m ²) 552118-341550HK Preisgr. A211 (m ²) 552117-341550HK Preisgr. A229 (m ²) 552113-341550HK Preisgr. A229 (m ²) 552112-341550HK ¹ Preisgr. A259 (m ²) 5716-341550HK ^{1/4} Preisgr. A259 (m ²) 552001-341550HK Preisgr. A229 (m ²) 552002-341550HK ¹ Preisgr. A259 (m ²) 552003-341550HK Preisgr. A229 (m ²) 552004-341550HK ¹ Preisgr. A259 (m ²) 552005-341550HK ¹ Preisgr. A259 (m ²) 552006-341550HK ¹ Preisgr. A259 (m ²) 552007-341550HK ¹ Preisgr. A259 (m ²) 552008-341550HK ¹ Preisgr. A259 (m ²) 552009-341550HK ¹ Preisgr. A259 (m ²) 552010-341550HK ¹ Preisgr. A259 (m ²) 552011-341550HK ¹ Preisgr. A259 (m ²) 552012-341550HK ^{1/4} Preisgr. A259 (m ²) 552013-341550HK ¹ Preisgr. A259 (m ²) 552014-341550HK ¹ Preisgr. A259 (m ²) 552015-341550HK ¹ Preisgr. A259 (m ²) 552016-341550HK ¹ Preisgr. A259 (m ²)	352010HK 700i-352010HK Preisgr. A265 (m ²) 701i-352010HK Preisgr. A265 (m ²) 552119-352010HK ¹ Preisgr. A313 (m ²) 552118-352010HK Preisgr. A265 (m ²) 552117-352010HK Preisgr. A289 (m ²) 552115-352010HK Preisgr. A313 (m ²) 552113-352010HK Preisgr. A289 (m ²) 552112-352010HK ¹ Preisgr. A313 (m ²) 5716-352010HK ^{1/4} Preisgr. A313 (m ²) 552001-352010HK Preisgr. A289 (m ²) 552002-352010HK ¹ Preisgr. A313 (m ²) 552003-352010HK Preisgr. A289 (m ²) 552004-352010HK ¹ Preisgr. A313 (m ²) 552005-352010HK ¹ Preisgr. A313 (m ²) 552006-352010HK ¹ Preisgr. A313 (m ²) 552007-352010HK ¹ Preisgr. A313 (m ²) 552008-352010HK ¹ Preisgr. A313 (m ²) 552009-352010HK ¹ Preisgr. A313 (m ²) 552010-352010HK ¹ Preisgr. A313 (m ²) 552011-352010HK ¹ Preisgr. A313 (m ²) 552012-352010HK ^{1/4} Preisgr. A313 (m ²) 552013-352010HK ¹ Preisgr. A313 (m ²) 552014-352010HK ¹ Preisgr. A313 (m ²) 552015-352010HK ¹ Preisgr. A313 (m ²) 552016-352010HK ¹ Preisgr. A313 (m ²)	4 4 4 4 4 3 3 3 2 1 2 4 3 2 2 4 3 4 3 2 4 3 2 4 3 2 4 3 2 4 3 2	neutral 10 (aktivweiß glzd.) <input type="checkbox"/> VO neutral 10 (aktivweiß) <input type="checkbox"/> VO neutral 9 (weißgrau) <input type="checkbox"/> VO neutral 8 (lichtgrau) <input type="checkbox"/> VO neutral 7 (kieselgrau) <input type="checkbox"/> VO neutral 6 (perigräu) <input type="checkbox"/> VO neutral 5 (basaltgrau) <input type="checkbox"/> VO neutral 4 (graphitschwarz) <input type="checkbox"/> VO neutral 3 (asphaltischwarz) <input type="checkbox"/> VO neutral 2 (anthrazit) <input type="checkbox"/> VO neutral 1 (tiefschwarz) <input type="checkbox"/> VO azur aktiv <input type="checkbox"/> VO azur hell <input type="checkbox"/> VO azur mittel <input type="checkbox"/> VO azur dunkel <input type="checkbox"/> VO blau aktiv <input type="checkbox"/> VO blau hell <input type="checkbox"/> VO blau mittel <input type="checkbox"/> VO blau dunkel <input type="checkbox"/> VO türkis aktiv <input type="checkbox"/> VO türkis hell <input type="checkbox"/> VO türkis mittel <input type="checkbox"/> VO türkis dunkel <input type="checkbox"/> VO grün aktiv <input type="checkbox"/> VO grün hell <input type="checkbox"/> VO grün mittel <input type="checkbox"/> VO grün dunkel <input type="checkbox"/> VO



⁴ Produktionsbedingte Farbabweichung zum Standard ist möglich.

⁵ Auf Anfrage können auch definierte Farbverläufe und Mosaikbilder geliefert werden.

⁶ Ausnahme: neutral 10 (glänzend), eben, glänzend

⁷ Überglasierte Kanten anteilmäßig im Bogen
Duschassensystem: siehe Serie Plural non-slip, S. 363/365



Boden-/Wandfliesen

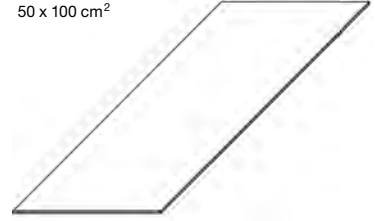
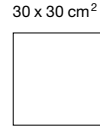

Formatnummer	15 x 15 cm	20 x 20 cm	25 x 50 cm ²	30 x 30 cm ²	30 x 60 cm ²	50 x 100 cm ²
Formatnummer	Beanspruchungsgruppe					
Nennmaß - cm/in	15 x 15 / 6 x 6	20 x 20 / 8 x 8	25 x 50 / 10 x 20	30 x 30 / 12 x 12	30 x 60 / 12 x 24	50 x 100 / 20 x 40
Herstellmaß	147 x 147 x 6,5 mm	197 x 197 x 6,5 mm	247 x 497 x 8 mm	297 x 297 x 8 mm	297 x 597 x 8 mm	497 x 997 x 8 mm
Oberfläche	eben, OP-geeig.	eben, OP-geeig.	eben, seidenmatt ⁴	eben, seidenmatt ⁴	eben, seidenmatt ⁴	eben, seidenmatt ⁴
m ² - Stück	44,000	25,000	8,000	11,111	5,556	2,000
m ² - kg	13,816	13,875	17,040	17,222	17,413	18,080
Paket - Stück	44	25	9	14	6	2
Paket - m ²	1,000	1,000	1,125	1,260	1,080	1,000
Paket - kg	13,816	13,875	19,170	21,700	18,804	18,080
Palette - m ²	80,000	72,000	40,500	52,921	43,197	52,000
Palette - kg	1.105,280	999,000	690,120	911,400	752,160	940,160
Produktnorm	Blb	Blb	Alb	Alb	Alb	Alb
Belastung	1	1	1	2	1	1
neutral 10 (aktivweiß glzd.) <input type="checkbox"/>	4 715-2121H NEU Preisgr. A115 (m ²)	720-2121H NEU Preisgr. A115 (m ²)	700i-342550HK Preisgr. A157 (m ²)	730-2121H Preisgr. A166 (m ²)	760-2121H Preisgr. A166 (m ²)	700i-352050HK Preisgr. A211 (m ²)
neutral 10 (aktivweiß) <input type="checkbox"/>	4 715-2120H Preisgr. A115 (m ²)	720-2120H Preisgr. A115 (m ²)	701i-342550HK Preisgr. A157 (m ²)	730-2120H Preisgr. A166 (m ²)	760-2120H Preisgr. A166 (m ²)	701i-352050HK Preisgr. A211 (m ²)
neutral 9 (weißgrau) <input type="checkbox"/>	4 715-2119H¹ Preisgr. A166 (m ²)	720-2119H¹ Preisgr. A166 (m ²)	552119-342550HK Preisgr. A181 (m ²)	730-2119H¹ Preisgr. A217 (m ²)	760-2119H¹ Preisgr. A217 (m ²)	552119-352050HK¹ Preisgr. A259 (m ²)
neutral 8 (lichtgrau) <input type="checkbox"/>	4 715-2118H Preisgr. A115 (m ²)	720-2118H Preisgr. A115 (m ²)	552118-342550HK Preisgr. A157 (m ²)	730-2118H Preisgr. A166 (m ²)	760-2118H Preisgr. A166 (m ²)	552118-352050HK Preisgr. A211 (m ²)
neutral 7 (kieselgrau) <input type="checkbox"/>	4 715-2117H¹ Preisgr. A166 (m ²)	720-2117H¹ Preisgr. A166 (m ²)	552117-342550HK Preisgr. A181 (m ²)	730-2117H¹ Preisgr. A217 (m ²)	760-2117H¹ Preisgr. A217 (m ²)	552117-352050HK Preisgr. A229 (m ²)
neutral 6 (perlgrau) <input type="checkbox"/>	3 715-2116H¹ Preisgr. A166 (m ²)	720-2116H¹ Preisgr. A166 (m ²)				
neutral 5 (basaltgrau) <input type="checkbox"/>	3 715-2115H¹ Preisgr. A166 (m ²)	720-2115H¹ Preisgr. A166 (m ²)	552115-342550HK Preisgr. A181 (m ²)	730-2115H¹ Preisgr. A217 (m ²)	760-2115H¹ Preisgr. A217 (m ²)	552115-352050HK¹ Preisgr. A259 (m ²)
neutral 4 (graphitschwarz) <input type="checkbox"/>	3 715-2114H Preisgr. A142 (m ²)	720-2114H Preisgr. A142 (m ²)				
neutral 3 (asphaltischwarz) <input type="checkbox"/>	3 715-2113H¹ Preisgr. A166 (m ²)	720-2113H¹ Preisgr. A166 (m ²)	552113-342550HK Preisgr. A181 (m ²)	730-2113H Preisgr. A187 (m ²)	760-2113H Preisgr. A187 (m ²)	552113-352050HK Preisgr. A229 (m ²)
neutral 2 (anthrazit) <input type="checkbox"/>	2 715-2112H Preisgr. A142 (m ²)	720-2112H Preisgr. A142 (m ²)	552112-342550HK Preisgr. A181 (m ²)	730-2112H¹ Preisgr. A217 (m ²)	760-2112H Preisgr. A187 (m ²)	552112-352050HK¹ Preisgr. A259 (m ²)
neutral 1 (tiefschwarz) <input type="checkbox"/>	1 715-2111H Preisgr. A142 (m ²)	720-2111H Preisgr. A142 (m ²)	5716-342550HK³ Preisgr. A181 (m ²)	730-2111H³ Preisgr. A217 (m ²)	760-2111H^{1/3} Preisgr. A217 (m ²)	5716-352050HK^{1/3} Preisgr. A259 (m ²)
azur aktiv <input type="checkbox"/>	2 715-2001H¹ Preisgr. A166 (m ²)	720-2001H¹ Preisgr. A166 (m ²)	552001-342550HK Preisgr. A181 (m ²)	730-2001H Preisgr. A187 (m ²)	760-2001H Preisgr. A187 (m ²)	552001-352050HK Preisgr. A229 (m ²)
azur hell <input type="checkbox"/>	4 715-2002H¹ Preisgr. A166 (m ²)	720-2002H¹ Preisgr. A166 (m ²)	552002-342550HK Preisgr. A181 (m ²)	730-2002H¹ Preisgr. A217 (m ²)	760-2002H¹ Preisgr. A217 (m ²)	552002-352050HK¹ Preisgr. A259 (m ²)
azur mittel <input type="checkbox"/>	3 715-2003H Preisgr. A142 (m ²)	720-2003H Preisgr. A142 (m ²)	552003-342550HK Preisgr. A181 (m ²)	730-2003H Preisgr. A187 (m ²)	760-2003H Preisgr. A187 (m ²)	552003-352050HK Preisgr. A229 (m ²)
azur dunkel <input type="checkbox"/>	2 715-2004H¹ Preisgr. A166 (m ²)	720-2004H Preisgr. A142 (m ²)	552004-342550HK Preisgr. A181 (m ²)	730-2004H¹ Preisgr. A217 (m ²)	760-2004H¹ Preisgr. A217 (m ²)	552004-352050HK¹ Preisgr. A259 (m ²)
blau aktiv <input type="checkbox"/>	2 715-2005H¹ Preisgr. A166 (m ²)	720-2005H¹ Preisgr. A166 (m ²)	552005-342550HK Preisgr. A181 (m ²)	730-2005H¹ Preisgr. A217 (m ²)	760-2005H¹ Preisgr. A217 (m ²)	552005-352050HK¹ Preisgr. A259 (m ²)
blau hell <input type="checkbox"/>	4 715-2006H¹ Preisgr. A166 (m ²)	720-2006H¹ Preisgr. A166 (m ²)	552006-342550HK Preisgr. A181 (m ²)	730-2006H¹ Preisgr. A217 (m ²)	760-2006H¹ Preisgr. A217 (m ²)	552006-352050HK¹ Preisgr. A259 (m ²)
blau mittel <input type="checkbox"/>	3 715-2007H Preisgr. A142 (m ²)	720-2007H Preisgr. A142 (m ²)	552007-342550HK Preisgr. A181 (m ²)	730-2007H¹ Preisgr. A217 (m ²)	760-2007H¹ Preisgr. A217 (m ²)	552007-352050HK¹ Preisgr. A259 (m ²)
blau dunkel <input type="checkbox"/>	2 715-2008H¹ Preisgr. A166 (m ²)	720-2008H Preisgr. A142 (m ²)	552008-342550HK Preisgr. A181 (m ²)	730-2008H¹ Preisgr. A217 (m ²)	760-2008H¹ Preisgr. A217 (m ²)	552008-352050HK¹ Preisgr. A259 (m ²)
türkis aktiv <input type="checkbox"/>	2 715-2009H¹ Preisgr. A166 (m ²)	720-2009H¹ Preisgr. A166 (m ²)	552009-342550HK Preisgr. A181 (m ²)	730-2009H¹ Preisgr. A217 (m ²)	760-2009H¹ Preisgr. A217 (m ²)	552009-352050HK¹ Preisgr. A259 (m ²)
türkis hell <input type="checkbox"/>	4 715-2010H Preisgr. A142 (m ²)	720-2010H Preisgr. A142 (m ²)	552010-342550HK Preisgr. A181 (m ²)	730-2010H¹ Preisgr. A217 (m ²)	760-2010H¹ Preisgr. A217 (m ²)	552010-352050HK¹ Preisgr. A259 (m ²)
türkis mittel <input type="checkbox"/>	3 715-2011H¹ Preisgr. A166 (m ²)	720-2011H¹ Preisgr. A166 (m ²)	552011-342550HK Preisgr. A181 (m ²)	730-2011H¹ Preisgr. A217 (m ²)	760-2011H¹ Preisgr. A217 (m ²)	552011-352050HK¹ Preisgr. A259 (m ²)
türkis dunkel <input type="checkbox"/>	2 715-2012H¹ Preisgr. A166 (m ²)	720-2012H¹ Preisgr. A166 (m ²)	552012-342550HK³ Preisgr. A181 (m ²)	730-2012H^{1/3} Preisgr. A217 (m ²)	760-2012H^{1/3} Preisgr. A217 (m ²)	552012-352050HK^{1/3} Preisgr. A259 (m ²)
grün aktiv <input type="checkbox"/>	2 715-2013H¹ Preisgr. A166 (m ²)	720-2013H¹ Preisgr. A166 (m ²)	552013-342550HK Preisgr. A181 (m ²)	730-2013H¹ Preisgr. A217 (m ²)	760-2013H¹ Preisgr. A217 (m ²)	552013-352050HK¹ Preisgr. A259 (m ²)
grün hell <input type="checkbox"/>	4 715-2014H Preisgr. A142 (m ²)	720-2014H Preisgr. A142 (m ²)	552014-342550HK Preisgr. A181 (m ²)	730-2014H¹ Preisgr. A217 (m ²)	760-2014H¹ Preisgr. A217 (m ²)	552014-352050HK¹ Preisgr. A259 (m ²)
grün mittel <input type="checkbox"/>	3 715-2015H¹ Preisgr. A166 (m ²)	720-2015H¹ Preisgr. A166 (m ²)	552015-342550HK Preisgr. A181 (m ²)	730-2015H¹ Preisgr. A217 (m ²)	760-2015H¹ Preisgr. A217 (m ²)	552015-352050HK¹ Preisgr. A259 (m ²)
grün dunkel <input type="checkbox"/>	2 715-2016H¹ Preisgr. A166 (m ²)	720-2016H¹ Preisgr. A166 (m ²)	552016-342550HK Preisgr. A181 (m ²)	730-2016H¹ Preisgr. A217 (m ²)	760-2016H¹ Preisgr. A217 (m ²)	552016-352050HK¹ Preisgr. A259 (m ²)



³ Produktionsbedingte Farbabweichung zum Standard ist möglich
⁴ Ausnahme: neutral 10 (glänzend), eben, glänzend

Mosaik

2,5 x 2,5 cm^{3/5}

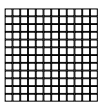

5 x 5 cm^{3/5}

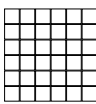

10 x 10 cm^{3/5/6}

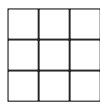

Boden-/Wandfliesen

10 x 20 cm **NEU**



10 x 30 cm



12,5 x 50 cm²



12,5 x 100 cm²



Bogen: 297 x 297 mm

Bogen: 297 x 297 mm

Bogen: 297 x 297 mm

2,5 x 2,5 / 1 x 1 23 x 23 x 6,5 mm eben, OP-geeig. 11 Bögen 12,100 11 Bögen 1,000 12,100 48,000 580,800 Blb 1	5 x 5 / 2 x 2 47 x 47 x 6,5 mm eben, OP-geeig. 11 Bögen 12,331 11 Bögen 1,000 12,331 64,000 789,184 Blb 1	10 x 10 / 4 x 4 97 x 97 x 6,5 mm eben, OP-geeig. 11 Bögen 13,101 11 Bögen 1,000 13,101 64,000 838,464 Blb 1	10 x 20 / 4 x 8 97 x 197 x 6,5 mm eben, OP-geeig. 50,000 13,600 33 0,660 8,976 59,400 807,840 Blb 1	703 10 x 30 / 4 x 12 97 x 297 x 6 mm eben, seidenmatt 50,000 12,333 38 1,140 14,060 95,770 1.181,040 Alb 1	341550HK 12,5 x 50 / 5 x 20 122 x 497 x 8 mm eben, seidenmatt 16,000 17,040 8 0,500 8,520 55,000 937,200 Alb 1	352010HK 12,5 x 100 / 5 x 40 122 x 997 x 8 mm eben, seidenmatt 8,000 17,040 10 1,250 21,300 67,500 1.150,200 Alb 1	Beanspruchungsgruppe Formatnummer Nennmaß - cm/in Herstellmaß Oberfläche m ² - Stück m ² - kg Paket - Stück Paket - m ² Palette - m ² Palette - kg Produktnorm Belastung
702-2018H ¹ Preisgr. A280 (m ²)	705-2017H Preisgr. A211 (m ²)	710-2017H Preisgr. A157 (m ²)	712-2017H ¹ Preisgr. A211 (m ²)	703-2017H ^{1/4} Preisgr. A187 (m ²)	552017-341550HK ^{1/4} Preisgr. A259 (m ²)	552017-352010HK ^{1/4} Preisgr. A313 (m ²)	2
702-2019H ¹ Preisgr. A280 (m ²)	705-2018H Preisgr. A211 (m ²)	710-2018H Preisgr. A157 (m ²)	712-2018H ¹ Preisgr. A211 (m ²)	703-2018H ¹ Preisgr. A187 (m ²)	552018-341550HK ¹ Preisgr. A259 (m ²)	552018-352010HK ¹ Preisgr. A313 (m ²)	4
702-2020H ¹ Preisgr. A280 (m ²)	705-2019H Preisgr. A211 (m ²)	710-2019H Preisgr. A157 (m ²)	712-2019H ¹ Preisgr. A211 (m ²)	703-2019H ¹ Preisgr. A187 (m ²)	552019-341550HK ¹ Preisgr. A259 (m ²)	552019-352010HK ¹ Preisgr. A313 (m ²)	3
	705-2020H Preisgr. A211 (m ²)	710-2020H Preisgr. A157 (m ²)	712-2020H Preisgr. A178 (m ²)	703-2020H ^{1/4} Preisgr. A187 (m ²)	552020-341550HK ^{1/4} Preisgr. A259 (m ²)	552020-352010HK ^{1/4} Preisgr. A313 (m ²)	2
	705-2021H Preisgr. A211 (m ²)	710-2021H Preisgr. A157 (m ²)	712-2021H ¹ Preisgr. A211 (m ²)	703-2021H ^{1/4} Preisgr. A187 (m ²)	552021-341550HK ^{1/4} Preisgr. A259 (m ²)	552021-352010HK ^{1/4} Preisgr. A313 (m ²)	2
702-2022H ¹ Preisgr. A280 (m ²)	705-2022H Preisgr. A211 (m ²)	710-2022H Preisgr. A157 (m ²)	712-2022H ¹ Preisgr. A211 (m ²)	703-2022H ¹ Preisgr. A187 (m ²)	552022-341550HK ¹ Preisgr. A259 (m ²)	552022-352010HK ¹ Preisgr. A313 (m ²)	4
702-2023H ¹ Preisgr. A280 (m ²)	705-2023H Preisgr. A211 (m ²)	710-2023H Preisgr. A157 (m ²)	712-2023H ¹ Preisgr. A211 (m ²)	703-2023H ¹ Preisgr. A187 (m ²)	552023-341550HK ¹ Preisgr. A259 (m ²)	552023-352010HK ¹ Preisgr. A313 (m ²)	3
702-2024H ¹ Preisgr. A280 (m ²)	705-2024H Preisgr. A211 (m ²)	710-2024H Preisgr. A157 (m ²)	712-2024H Preisgr. A178 (m ²)	703-2024H ¹ Preisgr. A187 (m ²)	552024-341550HK ¹ Preisgr. A259 (m ²)	552024-352010HK ¹ Preisgr. A313 (m ²)	2
	705-2025H Preisgr. A211 (m ²)	710-2025H Preisgr. A157 (m ²)	712-2025H Preisgr. A211 (m ²)	703-2025H ^{1/4} Preisgr. A187 (m ²)	552025-341550HK ^{1/4} Preisgr. A259 (m ²)	552025-352010HK ^{1/4} Preisgr. A313 (m ²)	2
702-2026H ¹ Preisgr. A280 (m ²)	705-2026H Preisgr. A211 (m ²)	710-2026H Preisgr. A157 (m ²)	712-2026H Preisgr. A211 (m ²)	703-2026H ¹ Preisgr. A187 (m ²)	552026-341550HK ¹ Preisgr. A259 (m ²)	552026-352010HK ¹ Preisgr. A313 (m ²)	4
702-2027H ¹ Preisgr. A280 (m ²)	705-2027H Preisgr. A211 (m ²)	710-2027H Preisgr. A157 (m ²)	712-2027H Preisgr. A211 (m ²)	703-2027H ¹ Preisgr. A187 (m ²)	552027-341550HK ¹ Preisgr. A259 (m ²)	552027-352010HK ¹ Preisgr. A313 (m ²)	3
702-2028H ¹ Preisgr. A280 (m ²)	705-2028H Preisgr. A211 (m ²)	710-2028H Preisgr. A157 (m ²)	712-2028H Preisgr. A178 (m ²)	703-2028H ¹ Preisgr. A187 (m ²)	552028-341550HK ¹ Preisgr. A259 (m ²)	552028-352010HK ¹ Preisgr. A313 (m ²)	2
	705-2029H Preisgr. A211 (m ²)	710-2029H Preisgr. A157 (m ²)	712-2029H ¹ Preisgr. A211 (m ²)	703-2029H ¹ Preisgr. A187 (m ²)	552029-341550HK ¹ Preisgr. A259 (m ²)	552029-352010HK ¹ Preisgr. A313 (m ²)	2
702-2030H ¹ Preisgr. A280 (m ²)	705-2030H Preisgr. A211 (m ²)	710-2030H Preisgr. A157 (m ²)	712-2030H ¹ Preisgr. A211 (m ²)	703-2030H ¹ Preisgr. A187 (m ²)	552030-341550HK ¹ Preisgr. A259 (m ²)	552030-352010HK ¹ Preisgr. A313 (m ²)	4
702-2031H ¹ Preisgr. A280 (m ²)	705-2031H Preisgr. A211 (m ²)	710-2031H Preisgr. A157 (m ²)	712-2031H ¹ Preisgr. A211 (m ²)	703-2031H ¹ Preisgr. A187 (m ²)	552031-341550HK ¹ Preisgr. A259 (m ²)	552031-352010HK ¹ Preisgr. A313 (m ²)	3
702-2032H ¹ Preisgr. A280 (m ²)	705-2032H Preisgr. A211 (m ²)	710-2032H Preisgr. A157 (m ²)	712-2032H Preisgr. A178 (m ²)	703-2032H ¹ Preisgr. A187 (m ²)	552032-341550HK ¹ Preisgr. A259 (m ²)	552032-352010HK ¹ Preisgr. A313 (m ²)	2
	705-2033H Preisgr. A211 (m ²)	710-2033H Preisgr. A157 (m ²)	712-2033H ¹ Preisgr. A211 (m ²)	703-2033H ¹ Preisgr. A187 (m ²)	552033-341550HK ¹ Preisgr. A259 (m ²)	552033-352010HK ¹ Preisgr. A313 (m ²)	2
702-2034H ¹ Preisgr. A280 (m ²)	705-2034H Preisgr. A211 (m ²)	710-2034H Preisgr. A157 (m ²)	712-2034H ¹ Preisgr. A211 (m ²)	703-2034H ¹ Preisgr. A187 (m ²)	552034-341550HK ¹ Preisgr. A259 (m ²)	552034-352010HK ¹ Preisgr. A313 (m ²)	4
702-2035H ¹ Preisgr. A280 (m ²)	705-2035H Preisgr. A211 (m ²)	710-2035H Preisgr. A157 (m ²)	712-2035H ¹ Preisgr. A211 (m ²)	703-2035H Preisgr. A157 (m ²)	552035-341550HK Preisgr. A229 (m ²)	552035-352010HK Preisgr. A289 (m ²)	3
702-2036H Preisgr. A280 (m ²)	705-2036H Preisgr. A211 (m ²)	710-2036H Preisgr. A157 (m ²)	712-2036H Preisgr. A178 (m ²)	703-2036H ¹ Preisgr. A187 (m ²)	552036-341550HK ¹ Preisgr. A259 (m ²)	552036-352010HK ¹ Preisgr. A313 (m ²)	2
	705-2037H Preisgr. A211 (m ²)	710-2037H Preisgr. A157 (m ²)	712-2037H ¹ Preisgr. A211 (m ²)	703-2037H ¹ Preisgr. A187 (m ²)	552037-341550HK ¹ Preisgr. A259 (m ²)	552037-352010HK ¹ Preisgr. A313 (m ²)	2
702-2038H ¹ Preisgr. A280 (m ²)	705-2038H Preisgr. A211 (m ²)	710-2038H Preisgr. A157 (m ²)	712-2038H ¹ Preisgr. A211 (m ²)	703-2038H ¹ Preisgr. A187 (m ²)	552038-341550HK ¹ Preisgr. A259 (m ²)	552038-352010HK ¹ Preisgr. A313 (m ²)	4
702-2039H ¹ Preisgr. A280 (m ²)	705-2039H Preisgr. A211 (m ²)	710-2039H Preisgr. A157 (m ²)	712-2039H ¹ Preisgr. A211 (m ²)	703-2039H Preisgr. A157 (m ²)	552039-341550HK Preisgr. A229 (m ²)	552039-352010HK Preisgr. A289 (m ²)	3
702-2040H Preisgr. A280 (m ²)	705-2040H Preisgr. A211 (m ²)	710-2040H Preisgr. A157 (m ²)	712-2040H Preisgr. A178 (m ²)	703-2040H ¹ Preisgr. A187 (m ²)	552040-341550HK ¹ Preisgr. A259 (m ²)	552040-352010HK ¹ Preisgr. A313 (m ²)	2



⁴ Produktionsbedingte Farbabweichung zum Standard ist möglich.
⁵ Auf Anfrage können auch definierte Farbverläufe und Mosaikbilder geliefert werden.
⁶ Überglaste Kanten anteilmäßig im Bogen
 Duschtassensystem: siehe Serie Plural non-slip, S. 363/365



Boden-/Wandfliesen

15 x 15 cm



20 x 20 cm



25 x 50 cm²



30 x 30 cm²



30 x 60 cm²



50 x 100 cm²

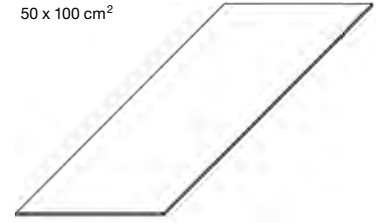

Formatnummer	15 x 15 cm	20 x 20 cm	25 x 50 cm ²	30 x 30 cm ²	30 x 60 cm ²	50 x 100 cm ²
Nennmaß - cm/in	15 x 15 / 6 x 6	20 x 20 / 8 x 8	25 x 50 / 10 x 20	30 x 30 / 12 x 12	30 x 60 / 12 x 24	50 x 100 / 20 x 40
Herstellmaß	147 x 147 x 6,5 mm	197 x 197 x 6,5 mm	247 x 497 x 8 mm	297 x 297 x 8 mm	297 x 597 x 8 mm	497 x 997 x 8 mm
Oberfläche	eben, OP-geeig.	eben, OP-geeig.	eben, seidenmatt	eben, seidenmatt	eben, seidenmatt	eben, seidenmatt
m ² - Stück	44,000	25,000	8,000	11,111	5,556	2,000
m ² - kg	13,816	13,875	17,040	17,222	17,413	18,080
Paket - Stück	44	25	9	14	6	2
Paket - m ²	1,000	1,000	1,125	1,260	1,080	1,000
Paket - kg	13,816	13,875	19,170	21,700	18,804	18,080
Palette - m ²	80,000	72,000	40,500	52,921	43,197	52,000
Palette - kg	1.105,280	999,000	690,120	911,400	752,160	940,160
Produktnorm	Blb	Blb	Alb	Alb	Alb	Alb
Belastung	1	1	1	2	1	1
Beanspruchungsgruppe	2	2	3	3	3	3
gelb aktiv <input type="checkbox"/>	715-2017H ¹ Preisgr. A166 (m ²)	720-2017H Preisgr. A142 (m ²)	552017-342550HK ³ Preisgr. A181 (m ²)	730-2017H ^{1/3} Preisgr. A217 (m ²)	760-2017H ^{1/3} Preisgr. A217 (m ²)	552017-352050HK ^{1/3} Preisgr. A259 (m ²)
gelb hell <input type="checkbox"/>	4 715-2018H Preisgr. A142 (m ²)	720-2018H Preisgr. A142 (m ²)	552018-342550HK Preisgr. A181 (m ²)	730-2018H ¹ Preisgr. A217 (m ²)	760-2018H ¹ Preisgr. A217 (m ²)	552018-352050HK ¹ Preisgr. A259 (m ²)
gelb mittel <input type="checkbox"/>	3 715-2019H ¹ Preisgr. A166 (m ²)	720-2019H ¹ Preisgr. A166 (m ²)	552019-342550HK Preisgr. A181 (m ²)	730-2019H ¹ Preisgr. A217 (m ²)	760-2019H ¹ Preisgr. A217 (m ²)	552019-352050HK ¹ Preisgr. A259 (m ²)
gelb dunkel <input type="checkbox"/>	2 715-2020H ¹ Preisgr. A166 (m ²)	720-2020H ¹ Preisgr. A166 (m ²)	552020-342550HK ³ Preisgr. A181 (m ²)	730-2020H ^{1/3} Preisgr. A217 (m ²)	760-2020H ^{1/3} Preisgr. A217 (m ²)	552020-352050HK ^{1/3} Preisgr. A259 (m ²)
ocker aktiv <input type="checkbox"/>	2 715-2021H ¹ Preisgr. A166 (m ²)	720-2021H ¹ Preisgr. A166 (m ²)	552021-342550HK ³ Preisgr. A181 (m ²)	730-2021H ^{1/3} Preisgr. A217 (m ²)	760-2021H ^{1/3} Preisgr. A217 (m ²)	552021-352050HK ^{1/3} Preisgr. A259 (m ²)
ocker hell <input type="checkbox"/>	4 715-2022H Preisgr. A142 (m ²)	720-2022H Preisgr. A142 (m ²)	552022-342550HK Preisgr. A181 (m ²)	730-2022H ¹ Preisgr. A217 (m ²)	760-2022H ¹ Preisgr. A217 (m ²)	552022-352050HK ¹ Preisgr. A259 (m ²)
ocker mittel <input type="checkbox"/>	3 715-2023H ¹ Preisgr. A166 (m ²)	720-2023H ¹ Preisgr. A166 (m ²)	552023-342550HK Preisgr. A181 (m ²)	730-2023H ¹ Preisgr. A217 (m ²)	760-2023H ¹ Preisgr. A217 (m ²)	552023-352050HK ¹ Preisgr. A259 (m ²)
ocker dunkel <input type="checkbox"/>	2 715-2024H ¹ Preisgr. A166 (m ²)	720-2024H ¹ Preisgr. A166 (m ²)	552024-342550HK Preisgr. A181 (m ²)	730-2024H ¹ Preisgr. A217 (m ²)	760-2024H ¹ Preisgr. A217 (m ²)	552024-352050HK ¹ Preisgr. A259 (m ²)
lachs aktiv <input type="checkbox"/>	2 715-2025H ¹ Preisgr. A166 (m ²)	720-2025H ¹ Preisgr. A166 (m ²)	552025-342550HK ³ Preisgr. A181 (m ²)	730-2025H ^{1/3} Preisgr. A217 (m ²)	760-2025H ^{1/3} Preisgr. A217 (m ²)	552025-352050HK ^{1/3} Preisgr. A259 (m ²)
lachs hell <input type="checkbox"/>	4 715-2026H Preisgr. A142 (m ²)	720-2026H ¹ Preisgr. A166 (m ²)	552026-342550HK Preisgr. A181 (m ²)	730-2026H ¹ Preisgr. A217 (m ²)	760-2026H ¹ Preisgr. A217 (m ²)	552026-352050HK ¹ Preisgr. A259 (m ²)
lachs mittel <input type="checkbox"/>	3 715-2027H Preisgr. A142 (m ²)	720-2027H Preisgr. A142 (m ²)	552027-342550HK Preisgr. A181 (m ²)	730-2027H ¹ Preisgr. A217 (m ²)	760-2027H ¹ Preisgr. A217 (m ²)	552027-352050HK ¹ Preisgr. A259 (m ²)
lachs dunkel <input type="checkbox"/>	2 715-2028H ¹ Preisgr. A166 (m ²)	720-2028H ¹ Preisgr. A166 (m ²)	552028-342550HK Preisgr. A181 (m ²)	730-2028H ¹ Preisgr. A217 (m ²)	760-2028H ¹ Preisgr. A217 (m ²)	552028-352050HK ¹ Preisgr. A259 (m ²)
oxidrot aktiv <input type="checkbox"/>	2 715-2029H ¹ Preisgr. A166 (m ²)	720-2029H ¹ Preisgr. A166 (m ²)	552029-342550HK Preisgr. A181 (m ²)	730-2029H ¹ Preisgr. A217 (m ²)	760-2029H ¹ Preisgr. A217 (m ²)	552029-352050HK ¹ Preisgr. A259 (m ²)
oxidrot hell <input type="checkbox"/>	4 715-2030H ¹ Preisgr. A166 (m ²)	720-2030H ¹ Preisgr. A166 (m ²)	552030-342550HK Preisgr. A181 (m ²)	730-2030H ¹ Preisgr. A217 (m ²)	760-2030H ¹ Preisgr. A217 (m ²)	552030-352050HK ¹ Preisgr. A259 (m ²)
oxidrot mittel <input type="checkbox"/>	3 715-2031H Preisgr. A142 (m ²)	720-2031H Preisgr. A142 (m ²)	552031-342550HK Preisgr. A181 (m ²)	730-2031H ¹ Preisgr. A217 (m ²)	760-2031H ¹ Preisgr. A217 (m ²)	552031-352050HK ¹ Preisgr. A259 (m ²)
oxidrot dunkel <input type="checkbox"/>	2 715-2032H ¹ Preisgr. A166 (m ²)	720-2032H ¹ Preisgr. A166 (m ²)	552032-342550HK Preisgr. A181 (m ²)	730-2032H ¹ Preisgr. A217 (m ²)	760-2032H ¹ Preisgr. A217 (m ²)	552032-352050HK ¹ Preisgr. A259 (m ²)
steingrau aktiv <input type="checkbox"/>	2 715-2033H ¹ Preisgr. A166 (m ²)	720-2033H ¹ Preisgr. A166 (m ²)	552033-342550HK Preisgr. A181 (m ²)	730-2033H ¹ Preisgr. A217 (m ²)	760-2033H ¹ Preisgr. A217 (m ²)	552033-352050HK ¹ Preisgr. A259 (m ²)
steingrau hell <input type="checkbox"/>	4 715-2034H ¹ Preisgr. A166 (m ²)	720-2034H ¹ Preisgr. A166 (m ²)	552034-342550HK Preisgr. A181 (m ²)	730-2034H ¹ Preisgr. A217 (m ²)	760-2034H ¹ Preisgr. A217 (m ²)	552034-352050HK ¹ Preisgr. A259 (m ²)
steingrau mittel <input type="checkbox"/>	3 715-2035H ¹ Preisgr. A166 (m ²)	720-2035H ¹ Preisgr. A166 (m ²)	552035-342550HK Preisgr. A181 (m ²)	730-2035H Preisgr. A187 (m ²)	760-2035H Preisgr. A187 (m ²)	552035-352050HK Preisgr. A229 (m ²)
steingrau dunkel <input type="checkbox"/>	2 715-2036H Preisgr. A142 (m ²)	720-2036H Preisgr. A142 (m ²)	552036-342550HK Preisgr. A181 (m ²)	730-2036H ¹ Preisgr. A217 (m ²)	760-2036H ¹ Preisgr. A217 (m ²)	552036-352050HK ¹ Preisgr. A259 (m ²)
sandgrau aktiv <input type="checkbox"/>	2 715-2037H ¹ Preisgr. A166 (m ²)	720-2037H ¹ Preisgr. A166 (m ²)	552037-342550HK Preisgr. A181 (m ²)	730-2037H ¹ Preisgr. A217 (m ²)	760-2037H ¹ Preisgr. A217 (m ²)	552037-352050HK ¹ Preisgr. A259 (m ²)
sandgrau hell <input type="checkbox"/>	4 715-2038H Preisgr. A142 (m ²)	720-2038H Preisgr. A142 (m ²)	552038-342550HK Preisgr. A181 (m ²)	730-2038H ¹ Preisgr. A217 (m ²)	760-2038H ¹ Preisgr. A217 (m ²)	552038-352050HK ¹ Preisgr. A259 (m ²)
sandgrau mittel <input type="checkbox"/>	3 715-2039H Preisgr. A142 (m ²)	720-2039H Preisgr. A142 (m ²)	552039-342550HK Preisgr. A181 (m ²)	730-2039H Preisgr. A187 (m ²)	760-2039H Preisgr. A187 (m ²)	552039-352050HK Preisgr. A229 (m ²)
sandgrau dunkel <input type="checkbox"/>	2 715-2040H Preisgr. A142 (m ²)	720-2040H Preisgr. A142 (m ²)	552040-342550HK Preisgr. A181 (m ²)	730-2040H ¹ Preisgr. A217 (m ²)	760-2040H ¹ Preisgr. A217 (m ²)	552040-352050HK ¹ Preisgr. A259 (m ²)



³ Produktionsbedingte Farbabweichung zum Standard ist möglich.

Mosaik **NEU** Boden-/ **NEU**
Wandfliesen

10 x 10 cm¹



20 x 20 cm¹



Bogen: 297 x 297 mm				
	10 x 10 / 4 x 4	20 x 20 / 8 x 8		Nennmaß - cm/in
	97 x 97 x 6,5 mm	197 x 197 x 6,5 mm		Herstellmaß
	eben, OP-geeig.	eben, OP-geeig.		Oberfläche
	11,000	25,000		m ² - Stück
	13,101	13,875		m ² - kg
	11	25		Paket - Stück
	1,000	1,000		Paket - m ²
	13,101	13,875		Paket - kg
	64,000	72,000		Palette - m ²
	838,464	999,000		Palette - kg
	Blb	Blb		Produktnorm
	1	1		Belastung
	710-2041H	720-2041H		violett <input type="checkbox"/>
	Preisgr. A196 (m ²)	Preisgr. A181 (m ²)		
	710-2042H	720-2042H		beerenrot <input type="checkbox"/>
	Preisgr. A196 (m ²)	Preisgr. A181 (m ²)		
	710-2043H	720-2043H		braunrot <input type="checkbox"/>
	Preisgr. A196 (m ²)	Preisgr. A181 (m ²)		
	710-2044H	720-2044H		feuerrot <input type="checkbox"/>
	Preisgr. A196 (m ²)	Preisgr. A181 (m ²)		
	710-2045H	720-2045H		signalorange <input type="checkbox"/>
	Preisgr. A196 (m ²)	Preisgr. A181 (m ²)		
	710-2046H	720-2046H		sonnengelb <input type="checkbox"/>
	Preisgr. A196 (m ²)	Preisgr. A181 (m ²)		
	710-2047H	720-2047H		gelbgrün <input type="checkbox"/>
	Preisgr. A196 (m ²)	Preisgr. A181 (m ²)		
	710-2048H	720-2048H		seegrün <input type="checkbox"/>
	Preisgr. A196 (m ²)	Preisgr. A181 (m ²)		
	710-2049H	720-2049H		blaugrün <input type="checkbox"/>
	Preisgr. A196 (m ²)	Preisgr. A181 (m ²)		
	710-2050H	720-2050H		kobaltblau <input type="checkbox"/>
	Preisgr. A196 (m ²)	Preisgr. A181 (m ²)		



Hohlkehls-
sockel¹

Innenecke
zu Hohlkehls-
sockel¹

Außenecke
zu Hohlkehls-
sockel¹

10 x 10 cm



Nennmaß - cm/in	10 x 10 / 4 x 4	100 x 18 x 6,5 mm	100 x 18 x 6,5 mm			
Herstellmaß	100 x 97 x 6,5 mm	100 x 18 x 6,5 mm	100 x 18 x 6,5 mm			
Oberfläche	eben, seidenmatt	eben, seidenmatt	eben, seidenmatt			
m ² - Stück	10,000					
m ² - kg	1,500/m	0,030/Stück	0,030/Stück			
Paket - Stück	40	40	30			
Paket - m ²	4,000					
Paket - kg	6,000					
Palette - m ²						
Palette - kg						
Produktnorm	B1b	B1b	B1b			
Trittsicherheit	Alb	Alb	Alb			
Belastung	1	1	1			
neutral 10 (aktivweiß) <input type="checkbox"/>	4 763-2120H Preisgr. A416 (St.)	759-2120H Preisgr. A430 (St.)	761-2120H Preisgr. A430 (St.)			
neutral 9 (weißgrau) <input type="checkbox"/>	4	759-2119H Preisgr. A430 (St.)	761-2119H Preisgr. A430 (St.)			
neutral 8 (lichtgrau) <input type="checkbox"/>	4 763-2118H Preisgr. A416 (St.)	759-2118H Preisgr. A430 (St.)	761-2118H Preisgr. A430 (St.)			
neutral 7 (kieselgrau) <input type="checkbox"/>	4	759-2117H Preisgr. A430 (St.)	761-2117H Preisgr. A430 (St.)			
neutral 5 (basaltgrau) <input type="checkbox"/>	3 763-2115H Preisgr. A416 (St.)	759-2115H Preisgr. A430 (St.)	761-2115H Preisgr. A430 (St.)			
neutral 3 (asphaltschwarz) <input type="checkbox"/>	3	759-2113H Preisgr. A430 (St.)	761-2113H Preisgr. A430 (St.)			
neutral 1 (tiefschwarz) <input type="checkbox"/>	1 763-2111H Preisgr. A416 (St.)	759-2111H Preisgr. A430 (St.)	761-2111H Preisgr. A430 (St.)			
azur aktiv <input type="checkbox"/>	2	759-2001H Preisgr. A430 (St.)	761-2001H Preisgr. A430 (St.)			
azur hell <input type="checkbox"/>	4	759-2002H Preisgr. A430 (St.)	761-2002H Preisgr. A430 (St.)			
azur mittel <input type="checkbox"/>	3 763-2003H Preisgr. A416 (St.)	759-2003H Preisgr. A430 (St.)	761-2003H Preisgr. A430 (St.)			
azur dunkel <input type="checkbox"/>	2	759-2004H Preisgr. A430 (St.)	761-2004H Preisgr. A430 (St.)			
blau hell <input type="checkbox"/>	4	759-2006H Preisgr. A430 (St.)	761-2006H Preisgr. A430 (St.)			
blau mittel <input type="checkbox"/>	3	759-2007H Preisgr. A430 (St.)	761-2007H Preisgr. A430 (St.)			
blau dunkel <input type="checkbox"/>	2	759-2008H Preisgr. A430 (St.)	761-2008H Preisgr. A430 (St.)			
türkis mittel <input type="checkbox"/>	3	759-2011H Preisgr. A430 (St.)	761-2011H Preisgr. A430 (St.)			
grün mittel <input type="checkbox"/>	3	759-2015H Preisgr. A430 (St.)	761-2015H Preisgr. A430 (St.)			
grün dunkel <input type="checkbox"/>	2	759-2016H Preisgr. A430 (St.)	761-2016H Preisgr. A430 (St.)			
gelb mittel <input type="checkbox"/>	3	759-2019H Preisgr. A430 (St.)	761-2019H Preisgr. A430 (St.)			
ocker mittel <input type="checkbox"/>	3	759-2023H Preisgr. A430 (St.)	761-2023H Preisgr. A430 (St.)			
lachs mittel <input type="checkbox"/>	3	759-2027H Preisgr. A430 (St.)	761-2027H Preisgr. A430 (St.)			
oxidrot mittel <input type="checkbox"/>	3	759-2031H Preisgr. A430 (St.)	761-2031H Preisgr. A430 (St.)			
steingrau hell <input type="checkbox"/>	4 763-2034H Preisgr. A416 (St.)	759-2034H Preisgr. A430 (St.)	761-2034H Preisgr. A430 (St.)			
steingrau dunkel <input type="checkbox"/>	2 763-2036H Preisgr. A416 (St.)	759-2036H Preisgr. A430 (St.)	761-2036H Preisgr. A430 (St.)			
sandgrau aktiv <input type="checkbox"/>	2 763-2037H Preisgr. A416 (St.)	759-2037H Preisgr. A430 (St.)	761-2037H Preisgr. A430 (St.)			
sandgrau dunkel <input type="checkbox"/>	2 763-2040H Preisgr. A416 (St.)	759-2040H Preisgr. A430 (St.)	761-2040H Preisgr. A430 (St.)			

¹ Details siehe S. 536
Produktionsbedingte Farbabweichungen zum angrenzenden Belag bei liegender Verlegung sind nicht reklamationstauglich



Saftbar "The Juizza" in der Opernpassage, Wien, Österreich / Architekt: Schuberth und Schuberth ZT-GmbH, Wien, Österreich / Foto: Christoph Panzer







360 Plural non-slip Steinzeug

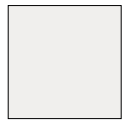

2120/2121
neutral 10 (aktivweiß)

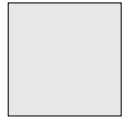

2119
neutral 9 (weißgrau)



2118
neutral 8 (lichtgrau)



2117
neutral 7 (kieselgrau)



2116
neutral 6 (perigräu)



2115
neutral 5 (basaltgräu)



2114
neutral 4 (graphitschwarz)



2113
neutral 3 (asphaltschwarz)



2112
neutral 2 (anthrazit)



2111
neutral 1 (tiefschwarz)



2004
azur dunkel



2003
azur mittel



2002
azur hell



2001
azur aktiv



2008
blau dunkel



2007
blau mittel



2006
blau hell



2005
blau aktiv



2012
türkis dunkel



2011
türkis mittel



2010
türkis hell



2009
türkis aktiv



2016
grün dunkel



2015
grün mittel



2014
grün hell



2013
grün aktiv



2020
gelb dunkel



2019
gelb mittel



2018
gelb hell



2017
gelb aktiv



2024
ocker dunkel



2023
ocker mittel



2022
ocker hell



2021
ocker aktiv



2028
lachs dunkel



2027
lachs mittel



2026
lachs hell



2025
lachs aktiv



2032
oxidrot dunkel



2031
oxidrot mittel



2030
oxidrot hell



2029
oxidrot aktiv



2036
steingrau dunkel



2035
steingrau mittel



2034
steingrau hell



2033
steingrau aktiv



2040
sandgräu dunkel



2039
sandgräu mittel

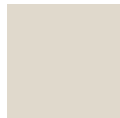

2038
sandgräu hell



2037
sandgräu aktiv

Mosaik 2,5 x 2,5 cm

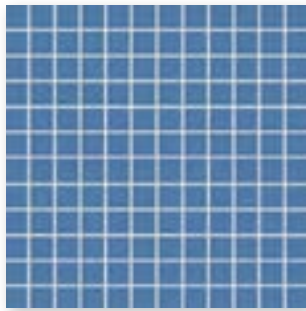

Mosaikbogen 30 x 30 cm, eben, R10/B



Hohlkehlssockel
10 x 10 cm, eben, R10/B



Duschtassensystem Ecke
10 x 10 cm, eben, R10/B



Innenecke
eben



Außenecke
eben



Duschtassensystem Läufer
10 x 10 cm, eben, R10/B

Mosaik 5 x 5 cm

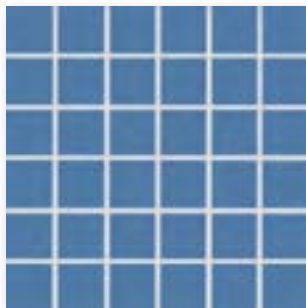

Mosaikbogen 30 x 30 cm, eben, R10/B

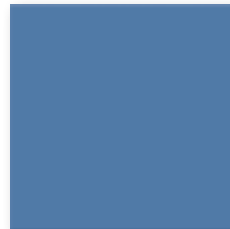

Bodenfliese 20 x 20 cm, eben, R10/B

Mosaik 10 x 10 cm

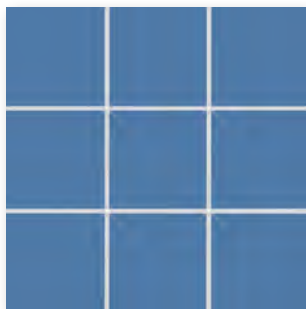

Mosaikbogen 30 x 30 cm, eben, R10/B



Bodenfliese 30 x 60 cm, eben, R10/B



Rückseitig thermoplastisch verklebte Mosaik von Agrob Buchtal sind nicht nur im Trockenbereich, sondern auch bedenkenlos im Unterwasserbereich (z. B. Schwimmbecken/Whirlpool) sowie im dauernassbelasteten Bereich (z. B. Beckenumgänge/Duschen) einsetzbar.

Kennen Sie schon unseren Mosaic Designer auf unserer Website www.agrob-buchtal.de? Hier haben Sie die Möglichkeit Ihre individuellen Farbverläufe, Mosaikmischungen und Bildverlegungen zu gestalten.

Mosaik^{2/4}

2,5 x 2,5 cm

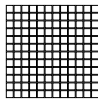

5 x 5 cm

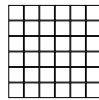

10 x 10 cm

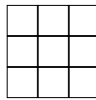

Wand-/Bodenfliesen

20 x 20 cm



30 x 60 cm^{1/3}



Nennmaß - cm/in	2,5 x 2,5 / 1 x 1	5 x 5 / 2 x 2	10 x 10 / 4 x 4	20 x 20 / 8 x 8	30 x 60 / 12 x 24
Herstellmaß	23 x 23 x 6,5 mm	47 x 47 x 6,5 mm	97 x 97 x 6,5 mm	197 x 197 x 6,5 mm	297 x 597 x 8 mm
Oberfläche	eben, matt	eben, matt	eben, matt	eben, matt	eben, matt
m ² - Stück	11 Bögen	11 Bögen	11 Bögen	25,000	5,556
m ² - kg	12,100	12,331	13,101	13,875	17,413
Paket - Stück	11 Bögen	11 Bögen	11 Bögen	25	6
Paket - m ²	1,000	1,000	1,000	1,000	1,080
Paket - kg	12,100	12,331	13,101	13,875	18,804
Palette - m ²	48,000	64,000	64,000	72,000	43,197
Palette - kg	580,800	789,184	838,464	999,000	752,160
Produktnorm	Blb	Blb	Blb	Blb	Alb
Trittsicherheit	R10/B	R10/B	R10/B	R10/B	R10/B
Belastung	1	1	1	1	2
neutral 10 (aktivweiß) <input type="checkbox"/>	4 902-2120H Preisgr. A238 (m ²)	905-2120H Preisgr. A205 (m ²)	910-2120H Preisgr. A166 (m ²)	920-2120H Preisgr. A148 (m ²)	980-2120H Preisgr. A181 (m ²)
neutral 9 (weißgrau) <input type="checkbox"/>	4 902-2119H¹ Preisgr. A289 (m ²)	905-2119H¹ Preisgr. A250 (m ²)	910-2119H Preisgr. A190 (m ²)	920-2119H¹ Preisgr. A190 (m ²)	
neutral 8 (lichtgrau) <input type="checkbox"/>	4 902-2118H Preisgr. A238 (m ²)	905-2118H Preisgr. A205 (m ²)	910-2118H Preisgr. A166 (m ²)	920-2118H Preisgr. A148 (m ²)	980-2118H Preisgr. A205 (m ²)
neutral 7 (kieselgrau) <input type="checkbox"/>	4 902-2117H¹ Preisgr. A289 (m ²)	905-2117H¹ Preisgr. A256 (m ²)	910-2117H Preisgr. A190 (m ²)	920-2117H¹ Preisgr. A190 (m ²)	
neutral 6 (perlgrau) <input type="checkbox"/>	3 902-2116H¹ Preisgr. A289 (m ²)	905-2116H¹ Preisgr. A256 (m ²)	910-2116H¹ Preisgr. A223 (m ²)	920-2116H¹ Preisgr. A190 (m ²)	
neutral 5 (basaltgrau) <input type="checkbox"/>	3 902-2115H¹ Preisgr. A289 (m ²)	905-2115H¹ Preisgr. A256 (m ²)	910-2115H Preisgr. A190 (m ²)	920-2115H Preisgr. A166 (m ²)	
neutral 4 (graphitschwarz) <input type="checkbox"/>	3 902-2114H¹ Preisgr. A289 (m ²)	905-2114H¹ Preisgr. A256 (m ²)	910-2114H Preisgr. A190 (m ²)	920-2114H Preisgr. A166 (m ²)	
neutral 3 (asphaltschwarz) <input type="checkbox"/>	3 902-2113H¹ Preisgr. A289 (m ²)	905-2113H¹ Preisgr. A256 (m ²)	910-2113H Preisgr. A190 (m ²)	920-2113H¹ Preisgr. A190 (m ²)	
neutral 2 (anthrazit) <input type="checkbox"/>	2 902-2112H¹ Preisgr. A289 (m ²)	905-2112H¹ Preisgr. A256 (m ²)	910-2112H Preisgr. A190 (m ²)	920-2112H Preisgr. A166 (m ²)	
neutral 1 (tiefschwarz) <input type="checkbox"/>	1 902-2111H Preisgr. A259 (m ²)	905-2111H Preisgr. A229 (m ²)	910-2111H Preisgr. A190 (m ²)	920-2111H Preisgr. A166 (m ²)	980-2111H Preisgr. A181 (m ²)
azur aktiv <input type="checkbox"/>	2 902-2001H¹ Preisgr. A289 (m ²)	905-2001H¹ Preisgr. A256 (m ²)	910-2001H Preisgr. A190 (m ²)	920-2001H¹ Preisgr. A190 (m ²)	
azur hell <input type="checkbox"/>	4 902-2002H¹ Preisgr. A289 (m ²)	905-2002H¹ Preisgr. A256 (m ²)	910-2002H Preisgr. A190 (m ²)	920-2002H¹ Preisgr. A190 (m ²)	
azur mittel <input type="checkbox"/>	3 902-2003H Preisgr. A259 (m ²)	905-2003H Preisgr. A229 (m ²)	910-2003H Preisgr. A190 (m ²)	920-2003H Preisgr. A166 (m ²)	980-2003H Preisgr. A205 (m ²)
azur dunkel <input type="checkbox"/>	2 902-2004H Preisgr. A259 (m ²)	905-2004H¹ Preisgr. A256 (m ²)	910-2004H Preisgr. A190 (m ²)	920-2004H Preisgr. A166 (m ²)	
blau aktiv <input type="checkbox"/>	2 902-2005H¹ Preisgr. A289 (m ²)	905-2005H¹ Preisgr. A256 (m ²)	910-2005H¹ Preisgr. A223 (m ²)	920-2005H¹ Preisgr. A190 (m ²)	
blau hell <input type="checkbox"/>	4 902-2006H¹ Preisgr. A289 (m ²)	905-2006H¹ Preisgr. A256 (m ²)	910-2006H Preisgr. A190 (m ²)	920-2006H¹ Preisgr. A190 (m ²)	
blau mittel <input type="checkbox"/>	3 902-2007H¹ Preisgr. A289 (m ²)	905-2007H¹ Preisgr. A256 (m ²)	910-2007H Preisgr. A190 (m ²)	920-2007H Preisgr. A166 (m ²)	980-2007H Preisgr. A205 (m ²)
blau dunkel <input type="checkbox"/>	2 902-2008H Preisgr. A259 (m ²)	905-2008H Preisgr. A229 (m ²)	910-2008H Preisgr. A190 (m ²)	920-2008H Preisgr. A166 (m ²)	
türkis aktiv <input type="checkbox"/>	2 902-2009H¹ Preisgr. A289 (m ²)	905-2009H¹ Preisgr. A256 (m ²)	910-2009H¹ Preisgr. A223 (m ²)	920-2009H¹ Preisgr. A190 (m ²)	
türkis hell <input type="checkbox"/>	4 902-2010H¹ Preisgr. A289 (m ²)	905-2010H¹ Preisgr. A256 (m ²)	910-2010H¹ Preisgr. A223 (m ²)	920-2010H¹ Preisgr. A190 (m ²)	
türkis mittel <input type="checkbox"/>	3 902-2011H¹ Preisgr. A289 (m ²)	905-2011H¹ Preisgr. A256 (m ²)	910-2011H Preisgr. A190 (m ²)	920-2011H Preisgr. A166 (m ²)	980-2011H Preisgr. A205 (m ²)
türkis dunkel <input type="checkbox"/>	2 902-2012H¹ Preisgr. A289 (m ²)	905-2012H¹ Preisgr. A256 (m ²)	910-2012H¹ Preisgr. A223 (m ²)	920-2012H¹ Preisgr. A190 (m ²)	
grün aktiv <input type="checkbox"/>	2 902-2013H¹ Preisgr. A289 (m ²)	905-2013H¹ Preisgr. A256 (m ²)	910-2013H¹ Preisgr. A223 (m ²)	920-2013H¹ Preisgr. A190 (m ²)	
grün hell <input type="checkbox"/>	4 902-2014H¹ Preisgr. A289 (m ²)	905-2014H Preisgr. A229 (m ²)	910-2014H¹ Preisgr. A223 (m ²)	920-2014H¹ Preisgr. A190 (m ²)	
grün mittel <input type="checkbox"/>	3 902-2015H¹ Preisgr. A289 (m ²)	905-2015H¹ Preisgr. A256 (m ²)	910-2015H Preisgr. A190 (m ²)	920-2015H Preisgr. A166 (m ²)	980-2015H Preisgr. A205 (m ²)
grün dunkel <input type="checkbox"/>	2 902-2016H¹ Preisgr. A289 (m ²)	905-2016H¹ Preisgr. A256 (m ²)	910-2016H Preisgr. A190 (m ²)	920-2016H Preisgr. A166 (m ²)	

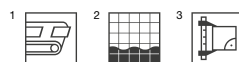

⁴ Auf Anfrage können auch definierte Farbverläufe und Mosaikbilder geliefert werden.

Hohlkehls-
sockel^{1/3}

10 x 10 cm



Innenecke
zu Hohlkehls-
sockel^{1/3}



Außenecke
zu Hohlkehls-
sockel^{1/3}



Duschtassensystem²

10 x 10 cm



10 x 10 cm



					Läufer		Ecke		Beanspruchungsgruppe
		10 x 10 / 4 x 4	100 x 18 x 6,5 mm	100 x 18 x 6,5 mm	10 x 10 / 4 x 4	10 x 10 / 4 x 4	10 x 10 / 4 x 4	10 x 10 / 4 x 4	
		100 x 97 x 6,5 mm			97 x 97 x 6,5 mm			97 x 97 x 6,5 mm	Nennmaß - cm/in
		eben, matt	eben, matt	eben, matt	eben, matt	eben, matt	eben, matt	eben, matt	Herstellmaß
		10,000			10,000			10,000	Oberfläche
		1,500/m	0,030/Stück	0,030/Stück	1,700/m	0,170/Stück	0,170/Stück	0,170/Stück	m - Stück
		40	40	30	16	4	4	4	m/St. - kg
		4,000			1,600			1,600	Paket - Stück
		6,000			2,720	0,680	0,680	0,680	Paket - m
									Paket - kg
									Palette - m
									Palette - kg
		Blb	Blb	Blb	Blb	Blb	Blb	Blb	Produktnorm
		R10/B			R10/B			R10/B	Trittsicherheit
		764-2120H	759-2120H	761-2120H	785-2120H	786-2120H	786-2120H	786-2120H	4 neutral 10
		Preisgr. A418 (St.)	Preisgr. A430 (St.)	Preisgr. A430 (St.)	Preisgr. A428 (St.)	Preisgr. A455 (St.)	Preisgr. A455 (St.)	Preisgr. A455 (St.)	(aktivweiß) <input type="checkbox"/>
		764-2119H	759-2119H	761-2119H	785-2119H	786-2119H	786-2119H	786-2119H	4 neutral 9
		Preisgr. A418 (St.)	Preisgr. A430 (St.)	Preisgr. A430 (St.)	Preisgr. A428 (St.)	Preisgr. A455 (St.)	Preisgr. A455 (St.)	Preisgr. A455 (St.)	(weißgrau) <input type="checkbox"/>
		764-2118H	759-2118H	761-2118H	785-2118H	786-2118H	786-2118H	786-2118H	4 neutral 8
		Preisgr. A418 (St.)	Preisgr. A430 (St.)	Preisgr. A430 (St.)	Preisgr. A428 (St.)	Preisgr. A455 (St.)	Preisgr. A455 (St.)	Preisgr. A455 (St.)	(lichtgrau) <input type="checkbox"/>
		764-2117H	759-2117H	761-2117H	785-2117H	786-2117H	786-2117H	786-2117H	4 neutral 7
		Preisgr. A418 (St.)	Preisgr. A430 (St.)	Preisgr. A430 (St.)	Preisgr. A428 (St.)	Preisgr. A455 (St.)	Preisgr. A455 (St.)	Preisgr. A455 (St.)	(kieselgrau) <input type="checkbox"/>
		764-2115H	759-2115H	761-2115H	785-2115H	786-2115H	786-2115H	786-2115H	3 neutral 5
		Preisgr. A418 (St.)	Preisgr. A430 (St.)	Preisgr. A430 (St.)	Preisgr. A428 (St.)	Preisgr. A455 (St.)	Preisgr. A455 (St.)	Preisgr. A455 (St.)	(basaltgrau) <input type="checkbox"/>
		764-2113H	759-2113H	761-2113H	785-2113H	786-2113H	786-2113H	786-2113H	3 neutral 3
		Preisgr. A418 (St.)	Preisgr. A430 (St.)	Preisgr. A430 (St.)	Preisgr. A428 (St.)	Preisgr. A455 (St.)	Preisgr. A455 (St.)	Preisgr. A455 (St.)	(asphaltschwarz) <input type="checkbox"/>
		764-2111H	759-2111H	761-2111H	785-2111H	786-2111H	786-2111H	786-2111H	1 neutral 1
		Preisgr. A418 (St.)	Preisgr. A430 (St.)	Preisgr. A430 (St.)	Preisgr. A428 (St.)	Preisgr. A455 (St.)	Preisgr. A455 (St.)	Preisgr. A455 (St.)	(tiefschwarz) <input type="checkbox"/>
		764-2001H	759-2001H	761-2001H	785-2001H	786-2001H	786-2001H	786-2001H	2 azur aktiv
		Preisgr. A418 (St.)	Preisgr. A430 (St.)	Preisgr. A430 (St.)	Preisgr. A428 (St.)	Preisgr. A455 (St.)	Preisgr. A455 (St.)	Preisgr. A455 (St.)	<input type="checkbox"/>
		764-2002H	759-2002H	761-2002H	785-2002H	786-2002H	786-2002H	786-2002H	4 azur hell
		Preisgr. A418 (St.)	Preisgr. A430 (St.)	Preisgr. A430 (St.)	Preisgr. A428 (St.)	Preisgr. A455 (St.)	Preisgr. A455 (St.)	Preisgr. A455 (St.)	<input type="checkbox"/>
		764-2003H	759-2003H	761-2003H	785-2003H	786-2003H	786-2003H	786-2003H	3 azur mittel
		Preisgr. A418 (St.)	Preisgr. A430 (St.)	Preisgr. A430 (St.)	Preisgr. A428 (St.)	Preisgr. A455 (St.)	Preisgr. A455 (St.)	Preisgr. A455 (St.)	<input type="checkbox"/>
		764-2004H	759-2004H	761-2004H	785-2004H	786-2004H	786-2004H	786-2004H	2 azur dunkel
		Preisgr. A418 (St.)	Preisgr. A430 (St.)	Preisgr. A430 (St.)	Preisgr. A428 (St.)	Preisgr. A455 (St.)	Preisgr. A455 (St.)	Preisgr. A455 (St.)	<input type="checkbox"/>
		764-2006H	759-2006H	761-2006H	785-2006H	786-2006H	786-2006H	786-2006H	4 blau hell
		Preisgr. A418 (St.)	Preisgr. A430 (St.)	Preisgr. A430 (St.)	Preisgr. A428 (St.)	Preisgr. A455 (St.)	Preisgr. A455 (St.)	Preisgr. A455 (St.)	<input type="checkbox"/>
		764-2007H	759-2007H	761-2007H	785-2007H	786-2007H	786-2007H	786-2007H	3 blau mittel
		Preisgr. A418 (St.)	Preisgr. A430 (St.)	Preisgr. A430 (St.)	Preisgr. A428 (St.)	Preisgr. A455 (St.)	Preisgr. A455 (St.)	Preisgr. A455 (St.)	<input type="checkbox"/>
		764-2008H	759-2008H	761-2008H	785-2008H	786-2008H	786-2008H	786-2008H	2 blau dunkel
		Preisgr. A418 (St.)	Preisgr. A430 (St.)	Preisgr. A430 (St.)	Preisgr. A428 (St.)	Preisgr. A455 (St.)	Preisgr. A455 (St.)	Preisgr. A455 (St.)	<input type="checkbox"/>
		764-2011H	759-2011H	761-2011H	785-2011H	786-2011H	786-2011H	786-2011H	3 türkis mittel
		Preisgr. A418 (St.)	Preisgr. A430 (St.)	Preisgr. A430 (St.)	Preisgr. A428 (St.)	Preisgr. A455 (St.)	Preisgr. A455 (St.)	Preisgr. A455 (St.)	<input type="checkbox"/>
		764-2015H	759-2015H	761-2015H	785-2015H	786-2015H	786-2015H	786-2015H	3 grün mittel
		Preisgr. A418 (St.)	Preisgr. A430 (St.)	Preisgr. A430 (St.)	Preisgr. A428 (St.)	Preisgr. A455 (St.)	Preisgr. A455 (St.)	Preisgr. A455 (St.)	<input type="checkbox"/>
		764-2016H	759-2016H	761-2016H	785-2016H	786-2016H	786-2016H	786-2016H	2 grün dunkel
		Preisgr. A418 (St.)	Preisgr. A430 (St.)	Preisgr. A430 (St.)	Preisgr. A428 (St.)	Preisgr. A455 (St.)	Preisgr. A455 (St.)	Preisgr. A455 (St.)	<input type="checkbox"/>

¹ Details siehe S. 536

² Details siehe S. 534

³ Produktionsbedingte Farbabweichungen zum angrenzenden Belag bei liegender Verlegung sind nicht reklamationsfähig



Mosaik^{2/4}

2,5 x 2,5 cm

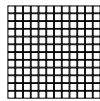

5 x 5 cm

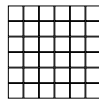

10 x 10 cm

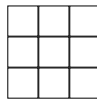

Wand-/Bodenfliesen

20 x 20 cm



30 x 60 cm^{1/3}

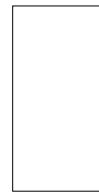

Bogen: 297 x 297 mm

Bogen: 297 x 297 mm

Bogen: 297 x 297 mm

Nennmaß - cm/in	2,5 x 2,5 / 1 x 1	5 x 5 / 2 x 2	10 x 10 / 4 x 4	20 x 20 / 8 x 8	30 x 60 / 12 x 24		
Herstellmaß	23 x 23 x 6,5 mm	47 x 47 x 6,5 mm	97 x 97 x 6,5 mm	197 x 197 x 6,5 mm	297 x 597 x 8 mm		
Oberfläche	eben, matt	eben, matt	eben, matt	eben, matt	eben, matt		
m ² - Stück	11 Bögen	11 Bögen	11 Bögen	25,000	5,556		
m ² - kg	12,100	12,331	13,101	13,875	17,413		
Paket - Stück	11 Bögen	11 Bögen	11 Bögen	25	6		
Paket - m ²	1,000	1,000	1,000	1,000	1,080		
Paket - kg	12,100	12,331	13,101	13,875	18,804		
Palette - m ²	48,000	64,000	64,000	72,000	43,197		
Palette - kg	580,800	789,184	838,464	999,000	752,160		
Produktnorm	Blb	Blb	Blb	Blb	Alb		
Trittsicherheit	R10/B	R10/B	R10/B	R10/B	R10/B		
Belastung	1	1	1	1	2		
gelb aktiv <input type="checkbox"/>	2 902-2017H ¹ Preisgr. A289 (m ²)	905-2017H ¹ Preisgr. A256 (m ²)	910-2017H ¹ Preisgr. A223 (m ²)	920-2017H ¹ Preisgr. A190 (m ²)			
gelb hell <input type="checkbox"/>	4 902-2018H ¹ Preisgr. A289 (m ²)	905-2018H ¹ Preisgr. A256 (m ²)	910-2018H ¹ Preisgr. A223 (m ²)	920-2018H ¹ Preisgr. A190 (m ²)			
gelb mittel <input type="checkbox"/>	3 902-2019H ¹ Preisgr. A289 (m ²)	905-2019H ¹ Preisgr. A256 (m ²)	910-2019H Preisgr. A190 (m ²)	920-2019H Preisgr. A166 (m ²)	980-2019H Preisgr. A205 (m ²)		
gelb dunkel <input type="checkbox"/>	2 902-2020H ¹ Preisgr. A289 (m ²)	905-2020H ¹ Preisgr. A256 (m ²)	910-2020H ¹ Preisgr. A223 (m ²)	920-2020H ¹ Preisgr. A190 (m ²)			
ocker aktiv <input type="checkbox"/>	2 902-2021H ¹ Preisgr. A289 (m ²)	905-2021H ¹ Preisgr. A256 (m ²)	910-2021H ¹ Preisgr. A223 (m ²)	920-2021H ¹ Preisgr. A190 (m ²)			
ocker hell <input type="checkbox"/>	4 902-2022H ¹ Preisgr. A289 (m ²)	905-2022H ¹ Preisgr. A256 (m ²)	910-2022H Preisgr. A190 (m ²)	920-2022H ¹ Preisgr. A190 (m ²)			
ocker mittel <input type="checkbox"/>	3 902-2023H ¹ Preisgr. A289 (m ²)	905-2023H ¹ Preisgr. A256 (m ²)	910-2023H Preisgr. A190 (m ²)	920-2023H Preisgr. A166 (m ²)	980-2023H Preisgr. A205 (m ²)		
ocker dunkel <input type="checkbox"/>	2 902-2024H ¹ Preisgr. A289 (m ²)	905-2024H ¹ Preisgr. A256 (m ²)	910-2024H ¹ Preisgr. A223 (m ²)	920-2024H ¹ Preisgr. A190 (m ²)			
lachs aktiv <input type="checkbox"/>	2 902-2025H ¹ Preisgr. A289 (m ²)	905-2025H ¹ Preisgr. A256 (m ²)	910-2025H ¹ Preisgr. A223 (m ²)	920-2025H ¹ Preisgr. A190 (m ²)			
lachs hell <input type="checkbox"/>	4 902-2026H ¹ Preisgr. A289 (m ²)	905-2026H ¹ Preisgr. A256 (m ²)	910-2026H ¹ Preisgr. A223 (m ²)	920-2026H ¹ Preisgr. A190 (m ²)			
lachs mittel <input type="checkbox"/>	3 902-2027H ¹ Preisgr. A289 (m ²)	905-2027H Preisgr. A229 (m ²)	910-2027H Preisgr. A190 (m ²)	920-2027H Preisgr. A166 (m ²)	980-2027H Preisgr. A205 (m ²)		
lachs dunkel <input type="checkbox"/>	2 902-2028H ¹ Preisgr. A289 (m ²)	905-2028H ¹ Preisgr. A256 (m ²)	910-2028H ¹ Preisgr. A223 (m ²)	920-2028H Preisgr. A166 (m ²)			
oxidrot aktiv <input type="checkbox"/>	2 902-2029H ¹ Preisgr. A289 (m ²)	905-2029H Preisgr. A229 (m ²)	910-2029H ¹ Preisgr. A223 (m ²)	920-2029H ¹ Preisgr. A190 (m ²)			
oxidrot hell <input type="checkbox"/>	4 902-2030H ¹ Preisgr. A289 (m ²)	905-2030H ¹ Preisgr. A256 (m ²)	910-2030H ¹ Preisgr. A223 (m ²)	920-2030H ¹ Preisgr. A190 (m ²)			
oxidrot mittel <input type="checkbox"/>	3 902-2031H ¹ Preisgr. A289 (m ²)	905-2031H ¹ Preisgr. A256 (m ²)	910-2031H Preisgr. A190 (m ²)	920-2031H Preisgr. A166 (m ²)	980-2031H Preisgr. A205 (m ²)		
oxidrot dunkel <input type="checkbox"/>	2 902-2032H ¹ Preisgr. A289 (m ²)	905-2032H ¹ Preisgr. A256 (m ²)	910-2032H ¹ Preisgr. A223 (m ²)	920-2032H ¹ Preisgr. A190 (m ²)			
steingrau aktiv <input type="checkbox"/>	2 902-2033H ¹ Preisgr. A289 (m ²)	905-2033H ¹ Preisgr. A256 (m ²)	910-2033H Preisgr. A190 (m ²)	920-2033H ¹ Preisgr. A190 (m ²)			
steingrau hell <input type="checkbox"/>	4 902-2034H ¹ Preisgr. A289 (m ²)	905-2034H ¹ Preisgr. A256 (m ²)	910-2034H Preisgr. A190 (m ²)	920-2034H ¹ Preisgr. A190 (m ²)			
steingrau mittel <input type="checkbox"/>	3 902-2035H ¹ Preisgr. A289 (m ²)	905-2035H ¹ Preisgr. A256 (m ²)	910-2035H Preisgr. A190 (m ²)	920-2035H Preisgr. A190 (m ²)			
steingrau dunkel <input type="checkbox"/>	2 902-2036H Preisgr. A259 (m ²)	905-2036H Preisgr. A229 (m ²)	910-2036H Preisgr. A190 (m ²)	920-2036H Preisgr. A166 (m ²)			
sandgrau aktiv <input type="checkbox"/>	2 902-2037H ¹ Preisgr. A289 (m ²)	905-2037H ¹ Preisgr. A256 (m ²)	910-2037H Preisgr. A190 (m ²)	920-2037H ¹ Preisgr. A190 (m ²)			
sandgrau hell <input type="checkbox"/>	4 902-2038H ¹ Preisgr. A289 (m ²)	905-2038H Preisgr. A229 (m ²)	910-2038H Preisgr. A190 (m ²)	920-2038H Preisgr. A166 (m ²)			
sandgrau mittel <input type="checkbox"/>	3 902-2039H ¹ Preisgr. A289 (m ²)	905-2039H Preisgr. A229 (m ²)	910-2039H Preisgr. A190 (m ²)	920-2039H Preisgr. A166 (m ²)	980-2039H Preisgr. A205 (m ²)		
sandgrau dunkel <input type="checkbox"/>	2 902-2040H Preisgr. A259 (m ²)	905-2040H Preisgr. A229 (m ²)	910-2040H Preisgr. A190 (m ²)	920-2040H Preisgr. A166 (m ²)			

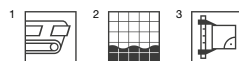

⁴ Auf Anfrage können auch definierte Farbverläufe und Mosaikbilder geliefert werden.

Hohlkehls-
sockel^{1/3}

10 x 10 cm



Innenecke
zu Hohlkehls-
sockel^{1/3}



Außenecke
zu Hohlkehls-
sockel^{1/3}



Duschtassensystem²

10 x 10 cm



10 x 10 cm



					Läufer	Ecke		Beanspruchungsgruppe	Nennmaß - cm/in Herstellmaß Oberfläche m - Stück m/St. - kg Paket - Stück Paket - m Paket - kg Palette - m Palette - kg Produktnorm Trittsicherheit Belastung
		10 x 10 / 4 x 4 100 x 97 x 6,5 mm eben, matt 10,000 1,500/m 40 4,000 6,000	100 x 18 x 6,5 mm eben, matt 0,030/Stück 40	100 x 18 x 6,5 mm eben, matt 0,030/Stück 30	10 x 10 / 4 x 4 97 x 97 x 6,5 mm eben, matt 10,000 1,700/m 16 1,600 2,720	10 x 10 / 4 x 4 97 x 97 x 6,5 mm eben, matt 0,170/Stück 4 0,680			
		764-2019H Preisgr. A418 (St.)	759-2019H Preisgr. A430 (St.)	761-2019H Preisgr. A430 (St.)	785-2019H Preisgr. A428 (St.)	786-2019H Preisgr. A455 (St.)		3	gelb mittel <input type="checkbox"/> VO
		764-2023H Preisgr. A418 (St.)	759-2023H Preisgr. A430 (St.)	761-2023H Preisgr. A430 (St.)	785-2023H Preisgr. A428 (St.)	786-2023H Preisgr. A455 (St.)		3	ocker mittel <input type="checkbox"/> VO
		764-2027H Preisgr. A418 (St.)	759-2027H Preisgr. A430 (St.)	761-2027H Preisgr. A430 (St.)	785-2027H Preisgr. A428 (St.)	786-2027H Preisgr. A455 (St.)		3	lachs mittel <input type="checkbox"/> VO
		764-2031H Preisgr. A418 (St.)	759-2031H Preisgr. A430 (St.)	761-2031H Preisgr. A430 (St.)	785-2031H Preisgr. A428 (St.)	786-2031H Preisgr. A455 (St.)		3	oxidrot mittel <input type="checkbox"/> VO
		764-2034H Preisgr. A418 (St.)	759-2034H Preisgr. A430 (St.)	761-2034H Preisgr. A430 (St.)	785-2034H Preisgr. A428 (St.)	786-2034H Preisgr. A455 (St.)		4	steingrau hell <input type="checkbox"/> VO
		764-2036H Preisgr. A418 (St.)	759-2036H Preisgr. A430 (St.)	761-2036H Preisgr. A430 (St.)	785-2036H Preisgr. A428 (St.)	786-2036H Preisgr. A455 (St.)		2	steingrau dunkel <input type="checkbox"/> VO
		764-2037H Preisgr. A418 (St.)	759-2037H Preisgr. A430 (St.)	761-2037H Preisgr. A430 (St.)	785-2037H Preisgr. A428 (St.)	786-2037H Preisgr. A455 (St.)		2	sandgrau aktiv <input type="checkbox"/> VO
		764-2040H Preisgr. A418 (St.)	759-2040H Preisgr. A430 (St.)	761-2040H Preisgr. A430 (St.)	785-2040H Preisgr. A428 (St.)	786-2040H Preisgr. A455 (St.)		2	sandgrau dunkel <input type="checkbox"/> VO

¹ Details siehe S. 536

² Details siehe S. 534

³ Produktionsbedingte Farbabweichungen zum angrenzenden Belag bei liegender Verlegung sind nicht reklamationsfähig







368 Plural unglasiert
Feinsteinzeug



R10/B R11/C



2008
blau dunkel



2040
sandgrau dunkel



2016
grün dunkel



2041
braun mittel



2023
ocker mittel



2042
grau mittel



2033
steingrau aktiv



2043
sandbeige mittel

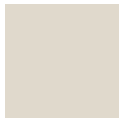

2038
sandweiß



2111
neutral 1 (tiefschwarz)



2039
sandgrau mittel



2113
neutral 3 (asphaltschwarz)

Mosaik 2,5 x 2,5 cm

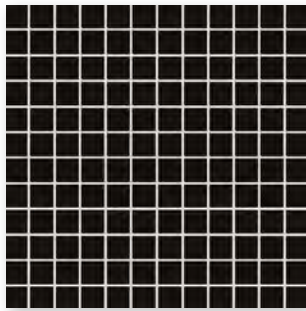

Mosaikbogen 30 x 30 cm, eben, R10/B



Bodenfliese 15 x 15 cm, eben, R10/B
Bodenfliese 15 x 15 cm, reliefiert, R11/C

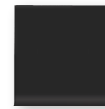

Hohlkehlsockel
10 x 10 cm, eben, R10/B



Duschtassensystem Ecke
10 x 10 cm, eben, R10/B

Mosaik 5 x 5 cm

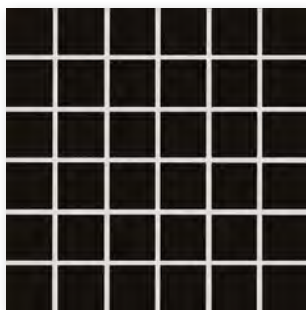

Mosaikbogen 30 x 30 cm, eben, R10/B



Bodenfliese 20 x 20 cm, eben, R10/B



Duschtassensystem Läufer
10 x 10 cm, eben, R10/B

Mosaik 10 x 10 cm



Mosaikbogen 30 x 30 cm, eben, R10/B
Mosaikbogen 30 x 30 cm, reliefiert, R11/C



Bodenfliese 30 x 60 cm, eben, R10/B



Rückseitig thermoplastisch verklebte Mosaik von Agrob Buchtal sind nicht nur im Trockenbereich, sondern auch bedenkenlos im Unterwasserbereich (z. B. Schwimmbecken/Whirlpool) sowie im dauernassbelasteten Bereich (z. B. Beckenumgänge/Duschen) einsetzbar.

Mosaik^{2/3}

Bodenfliesen



protected

2,5 x 2,5 cm

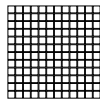

5 x 5 cm

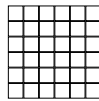

10 x 10 cm

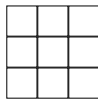

10 x 10 cm

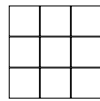

15 x 15 cm



15 x 15 cm



Bogen: 297 x 297 mm

Bogen: 297 x 297 mm

Bogen: 297 x 297 mm

Bogen: 297 x 297 mm

Nennmaß - cm/in	2,5 x 2,5 / 1 x 1	5 x 5 / 2 x 2	10 x 10 / 4 x 4	10 x 10 / 4 x 4	15 x 15 / 6 x 6	15 x 15 / 6 x 6
Herstellmaß	23 x 23 x 6,5 mm	47 x 47 x 6,5 mm	97 x 97 x 6,5 mm	97 x 97 x 6,5 mm	147 x 147 x 6,5 mm	147 x 147 x 6,5 mm
Oberfläche	eben, matt	eben, matt	eben, matt	reliefiert, matt	eben, matt	reliefiert, matt
m ² - Stück	11 Bögen	11 Bögen	11 Bögen	11 Bögen	44,000	44,000
m ² - kg	12,100	12,331	13,101	13,101	13,816	13,816
Paket - Stück	11 Bögen	11 Bögen	11 Bögen	11 Bögen	44	44
Paket - m ²	1,000	1,000	1,000	1,000	1,000	1,000
Paket - kg	12,100	12,331	13,101	13,101	13,816	13,816
Palette - m ²	48,000	64,000	64,000	64,000	80,000	80,000
Palette - kg	580,800	789,184	838,464	838,464	1.105,280	1.105,280
Produktnorm	Bla	Bla	Bla	Bla	Bla	Bla
Trittsicherheit	R10/B	R10/B	R10/B	R11/C	R10/B	R11/C
Belastung	1	1	1	1	1	1
neutral 3 (asphaltschwarz) <input type="checkbox"/>	410-2113 Preisgr. A199 (m ²)	610-2113 Preisgr. A175 (m ²)	810-2113 Preisgr. A136 (m ²)	811-2113 Preisgr. A166 (m ²)	812-2113 Preisgr. A127 (m ²)	813-2113 Preisgr. A148 (m ²)
neutral 1 (tiefschwarz) <input type="checkbox"/>	410-2111 Preisgr. A199 (m ²)	610-2111 Preisgr. A175 (m ²)	810-2111 Preisgr. A136 (m ²)	811-2111 Preisgr. A166 (m ²)	812-2111 Preisgr. A127 (m ²)	813-2111 Preisgr. A148 (m ²)
blau dunkel <input type="checkbox"/>	410-2008 Preisgr. A238 (m ²)	610-2008 Preisgr. A211 (m ²)	810-2008 Preisgr. A175 (m ²)		812-2008 ¹ NEU Preisgr. A160 (m ²)	
grün dunkel <input type="checkbox"/>	410-2016 ¹ NEU Preisgr. A253 (m ²)	610-2016 Preisgr. A211 (m ²)	810-2016 Preisgr. A175 (m ²)		812-2016 ¹ NEU Preisgr. A160 (m ²)	
ocker mittel <input type="checkbox"/>	410-2023 Preisgr. A238 (m ²)	610-2023 Preisgr. A211 (m ²)	810-2023 Preisgr. A175 (m ²)		812-2023 ¹ NEU Preisgr. A160 (m ²)	
steingrau aktiv <input type="checkbox"/>	410-2033 ¹ NEU Preisgr. A253 (m ²)	610-2033 Preisgr. A211 (m ²)	810-2033 Preisgr. A175 (m ²)		812-2033 ¹ NEU Preisgr. A160 (m ²)	
sandweiß <input type="checkbox"/>	410-2038 Preisgr. A199 (m ²)	610-2038 Preisgr. A175 (m ²)	810-2038 Preisgr. A136 (m ²)	811-2038 Preisgr. A166 (m ²)	812-2038 Preisgr. A127 (m ²)	813-2038 Preisgr. A148 (m ²)
sandgrau mittel <input type="checkbox"/>	410-2039 Preisgr. A199 (m ²)	610-2039 Preisgr. A175 (m ²)	810-2039 Preisgr. A136 (m ²)		812-2039 ¹ NEU Preisgr. A148 (m ²)	
sandgrau dunkel <input type="checkbox"/>	410-2040 Preisgr. A199 (m ²)	610-2040 Preisgr. A175 (m ²)	810-2040 Preisgr. A136 (m ²)		812-2040 ¹ NEU Preisgr. A148 (m ²)	
braun mittel <input type="checkbox"/>	410-2041 Preisgr. A238 (m ²)	610-2041 Preisgr. A211 (m ²)	810-2041 Preisgr. A175 (m ²)		812-2041 ¹ NEU Preisgr. A148 (m ²)	
grau mittel <input type="checkbox"/>	410-2042 Preisgr. A238 (m ²)	610-2042 Preisgr. A211 (m ²)	810-2042 Preisgr. A175 (m ²)	811-2042 Preisgr. A181 (m ²)	812-2042 Preisgr. A154 (m ²)	813-2042 Preisgr. A175 (m ²)
sandbeige mittel <input type="checkbox"/>	410-2043 Preisgr. A238 (m ²)	610-2043 Preisgr. A211 (m ²)	810-2043 Preisgr. A175 (m ²)		812-2043 ¹ NEU Preisgr. A160 (m ²)	

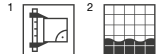

³ Auf Anfrage können auch definierte Farbverläufe und Mosaikbilder geliefert werden.

Bodenfliesen

20 x 20 cm



30 x 60 cm¹

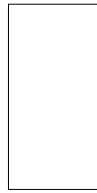

Hohlkehls-
sockel^{3/4}

10 x 10 cm



Duschtassensystem²

10 x 10 cm



10 x 10 cm



				Läufer	Ecke	
	20 x 20 / 8 x 8	30 x 60 / 12 x 24	10 x 10 / 4 x 4	10 x 10 / 4 x 4	10 x 10 / 4 x 4	Nennmaß - cm/in
	197 x 197 x 6,5 mm	297 x 597 x 6 mm	100 x 97 x 6,5 mm	97 x 97 x 6,5 mm	97 x 97 x 6,5 mm	Herstellmaß
	eben, matt	eben, matt	eben, matt	eben, matt	eben, matt	Oberfläche
	25,000/m ²	5,556/m ²	10,000/m	10,000/m		m ² /m - Stück
	13,875/m ²	13,273/m ²	1,500/m	1,700/m	0,170/Stück	m ² /mSt. - kg
	25	10	40	16	4	Paket - Stück
	1,000 m ²	1,800/m ²	4,000 m	1,600 m		Paket - m ² /m
	13,875	23,890	6,000	2,720	0,680	Paket - kg
	72,000	71,994				Palette - m ²
	999,000	955,600				Palette - kg
	Bla	Bla	Bla	Bla	Bla	Produktnorm
	R10/B	R10/B	R10/B	R10/B	R10/B	Trittsicherheit
	1	1				Belastung
	815-2113	806-2113	864-2113	885-2113	886-2113	neutral 3
	Preisgr. A115 (m ²)	Preisgr. A121 (m ²)	Preisgr. A419 (St.)	Preisgr. A445 (St.)	Preisgr. A475 (St.)	(asphaltschwarz) <input type="checkbox"/>
	815-2111	806-2111	864-2111	885-2111	886-2111	neutral 1
	Preisgr. A115 (m ²)	Preisgr. A121 (m ²)	Preisgr. A419 (St.)	Preisgr. A445 (St.)	Preisgr. A475 (St.)	(tiefschwarz) <input type="checkbox"/>
	815-2008		864-2008	885-2008	886-2008	blau dunkel <input type="checkbox"/>
	Preisgr. A148 (m ²)		Preisgr. A419 (St.)	Preisgr. A445 (St.)	Preisgr. A475 (St.)	<input type="checkbox"/>
	815-2016¹ NEU		864-2016			grün dunkel <input type="checkbox"/>
	Preisgr. A160 (m ²)		Preisgr. A419 (St.)			<input type="checkbox"/>
	815-2023		864-2023	885-2023	886-2023	ocker mittel <input type="checkbox"/>
	Preisgr. A148 (m ²)		Preisgr. A419 (St.)	Preisgr. A445 (St.)	Preisgr. A475 (St.)	<input type="checkbox"/>
	815-2033¹ NEU		864-2033			steingrau aktiv <input type="checkbox"/>
	Preisgr. A160 (m ²)		Preisgr. A419 (St.)			<input type="checkbox"/>
	815-2038	806-2038	864-2038	885-2038	886-2038	sandweiß <input type="checkbox"/>
	Preisgr. A115 (m ²)	Preisgr. A121 (m ²)	Preisgr. A419 (St.)	Preisgr. A445 (St.)	Preisgr. A475 (St.)	<input type="checkbox"/>
	815-2039		864-2039	885-2039	886-2039	sandgrau mittel <input type="checkbox"/>
	Preisgr. A115 (m ²)		Preisgr. A419 (St.)	Preisgr. A445 (St.)	Preisgr. A475 (St.)	<input type="checkbox"/>
	815-2040		864-2040	885-2040	886-2040	sandgrau dunkel <input type="checkbox"/>
	Preisgr. A115 (m ²)		Preisgr. A419 (St.)	Preisgr. A445 (St.)	Preisgr. A475 (St.)	<input type="checkbox"/>
	815-2041		864-2041	885-2041	886-2041	braun mittel <input type="checkbox"/>
	Preisgr. A148 (m ²)		Preisgr. A419 (St.)	Preisgr. A445 (St.)	Preisgr. A475 (St.)	<input type="checkbox"/>
	815-2042	806-2042	864-2042	885-2042	886-2042	grau mittel <input type="checkbox"/>
	Preisgr. A148 (m ²)	Preisgr. A121 (m ²)	Preisgr. A419 (St.)	Preisgr. A445 (St.)	Preisgr. A475 (St.)	<input type="checkbox"/>
	815-2043		864-2043	885-2043	886-2043	sandbeige mittel <input type="checkbox"/>
	Preisgr. A148 (m ²)		Preisgr. A419 (St.)	Preisgr. A445 (St.)	Preisgr. A475 (St.)	<input type="checkbox"/>



¹ Details siehe S. 534

² Details siehe S. 536

³ Produktionsbedingte Farbabweichungen zum angrenzenden Belag bei liegender Verlegung sind nicht reklamationsfähig.







Natürlich und lebhaft

Natürlich in der Anmutung, überzeugt Quarzit durch ungewöhnliche Glanz- und Glimmerpunkte lebendig nuancierter Oberfläche in authentischer Steinoptik. Zu den ästhetischen Vorzügen kommen praktische hinzu: Angenehme Haptik verbindet sich mit hoher Trittsicherheit und enormer Verschleißfestigkeit.

Studioaufnahme / Architekt: VSBL, Belgrad, Serbien / Foto: Jochen Stüber



basaltgrau



quarzgrau



sandbeige



sepiabraun



weißgrau

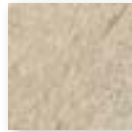

Bodenfliese 12,5 x 12,5 cm
strukturiert, R11/B



Bodenfliese 12,5 x 25 cm
strukturiert, R11/B



Rasterprofilfliese 12,5 x 25 cm
reliefiert, R11/C

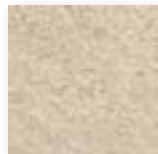

Bodenfliese 15 x 15 cm
strukturiert, R11/C



Bodenfliese 25 x 25 cm
strukturiert, R10/A,
Bodenfliese 25 x 25 cm
strukturiert, R11/B

Mosaik 5 x 5 cm



Mosaikbogen 30 x 30 cm
strukturiert, R11/B



Bodenfliese 25 x 50 cm, strukturiert, R10/A
Bodenfliese 25 x 50 cm, strukturiert, R11/B



Bodenfliese 30 x 60 cm, strukturiert, R10/A
Bodenfliese 30 x 60 cm, strukturiert, R11/B



Bodenfliese 60 x 60 cm, strukturiert, R10/A
Terrassenplatte 60 x 60 cm, strukturiert, R11/B



Treppenfliese mit Schräge 31 x 145 cm, strukturiert, R10/A



Setzstufe 28 x 145 cm, strukturiert, R10/A



basaltgrau



quarzgrau



sandbeige



sepiabraun



weißgrau



Schriftplatte 25 x 50 cm, strukturiert, R11/B



Sockel, geschnitten 6 x 50 cm, strukturiert



Sockel, geschnitten 6 x 60 cm, strukturiert



Hohlkehlsockel dekoriert 10 x 60 cm, strukturiert, R10/A



Rillenplatte 50 x 25 cm gerillt, R11/C



Rillenplatte 25 x 25 cm gerillt, R11/C



Rillenplatte 12,5 x 25 cm gerillt, R11/C



Rasterprofilfliese
25 x 50 cm, reliefiert, R11/C

Flachrinnensystem
(Muldentiefe 5 mm)



Flachrinne
50 x 25 cm, strukturiert, R11/B

ohne Abbildung: Rinnenstein mit Ablauf,
Gehrungspaar, Endstück

Keramische Rinnenabdeckung
50 x 25 cm, strukturiert



Keramische Rinnenabdeckung
Ecklösung 30 x 30 cm, strukturiert



Details zu Flachrinnen und Keramischer Rinnenabdeckung siehe Lieferprogramm Pool+Spa.

Bodenfliesen 3 mm Fuge

5 x 5 cm^{1/4}



15 x 15 cm



25 x 25 cm¹



25 x 25 cm¹



25 x 50 cm¹

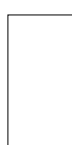

25 x 50 cm¹



25 x 50 cm^{1/2}



Bogen: 297 x 297 mm

7161H	342030H	332050HK	332050HK	342550HK	342550HK	342580HK	Rasterprofilfliese	Formatnummer
5 x 5 / 2 x 2	15 x 15 / 6 x 6	25 x 25 / 10 x 10	25 x 25 / 10 x 10	25 x 50 / 10 x 20	25 x 50 / 10 x 20	25 x 50 / 10 x 20		Nennmaß - cm/in
47 x 47 x 8 mm	147 x 147 x 8 mm	247 x 247 x 8 mm	247 x 247 x 8 mm	247 x 497 x 8 mm	247 x 497 x 8 mm	247 x 497 x 8 mm		Herstellmaß
strukturiert, matt	strukturiert, matt	strukturiert, matt	strukturiert, matt	strukturiert, matt	strukturiert, matt	reliefiert, matt		Oberfläche
11,111	44,444	16,000	16,000	8,000	8,000	8,000		m ² - Stück
16,389	17,555	16,960	16,960	17,040	17,040	17,040		m ² - kg
14	35	14	14	9	9	9		Paket - Stück
1,260	0,788	0,875	0,875	1,125	1,125	1,125		Paket - m ²
20,650	13,825	14,840	14,840	19,170	19,170	19,170		Paket - kg
37,800	63,001	70,875	70,875	40,500	40,500	40,500		Palette - m ²
619,500	1.106,000	1.202,040	1.202,040	690,120	690,120	690,120		Palette - kg
Ala	Bla	Ala	Ala	Ala	Ala	Ala		Produktnorm
R11/B	R11/C	R10/A	R11/B	R10/A	R11/B	R11/C		Trittsicherheit
2	2	2	2	2	2	2		Belastung
8460-7161H	8460-342030H	8450-332050HK	8460-332050HK	8450-342550HK	8460-342550HK	<i>8460-342580HK</i>		basaltgrau <input type="checkbox"/> V4
Preisgr. A289 (m ²)	Preisgr. A157 (m ²)	Preisgr. A148 (m ²)	Preisgr. A157 (m ²)	Preisgr. A157 (m ²)	Preisgr. A166 (m ²)	<i>Preisgr. A181</i> (m ²)		
8461-7161H	8461-342030H	8451-332050HK	8461-332050HK	8451-342550HK	8461-342550HK	<i>8461-342580HK</i>		quarzgrau <input type="checkbox"/> V4
Preisgr. A289 (m ²)	Preisgr. A157 (m ²)	Preisgr. A148 (m ²)	Preisgr. A157 (m ²)	Preisgr. A157 (m ²)	Preisgr. A166 (m ²)	<i>Preisgr. A181</i> (m ²)		
8462-7161H	8462-342030H	8452-332050HK	8462-332050HK	8452-342550HK	8462-342550HK	<i>8462-342580HK</i>		sandbeige <input type="checkbox"/> V4
Preisgr. A289 (m ²)	Preisgr. A157 (m ²)	Preisgr. A148 (m ²)	Preisgr. A157 (m ²)	Preisgr. A157 (m ²)	Preisgr. A166 (m ²)	<i>Preisgr. A181</i> (m ²)		
8463-7161H	8463-342030H	8453-332050HK	8463-332050HK	8453-342550HK	8463-342550HK	<i>8463-342580HK</i>		sepiabraun <input type="checkbox"/> V4
Preisgr. A289 (m ²)	Preisgr. A157 (m ²)	Preisgr. A148 (m ²)	Preisgr. A157 (m ²)	Preisgr. A157 (m ²)	Preisgr. A166 (m ²)	<i>Preisgr. A181</i> (m ²)		
8464-7161H	8464-342030H	8454-332050HK	8464-332050HK	8454-342550HK	8464-342550HK	<i>8464-342580HK</i>		weißgrau <input type="checkbox"/> V4
Preisgr. A289 (m ²)	Preisgr. A157 (m ²)	Preisgr. A148 (m ²)	Preisgr. A157 (m ²)	Preisgr. A157 (m ²)	Preisgr. A166 (m ²)	<i>Preisgr. A181</i> (m ²)		



Bodenfliesen 3 mm Fuge¹

30 x 60 cm



30 x 60 cm

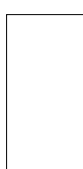

60 x 60 cm

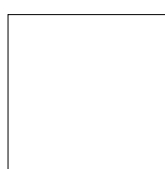

12,5 x 12,5 cm³



12,5 x 25 cm



12,5 x 25 cm²



Rasterprofilfliese

B200HK	B200HK	B600HK		32020H	38110H	34090H	Rasterprofilfliese	Formatnummer
30 x 60 / 12 x 24	30 x 60 / 12 x 24	60 x 60 / 24 x 24		12,5 x 12,5 / 5 x 5	12,5 x 25 / 5 x 10	12,5 x 25 / 5 x 10		Nennmaß - cm/in
297 x 597 x 8 mm	297 x 597 x 8 mm	597 x 597 x 8 mm		119 x 119 x 8 mm	119 x 244 x 8 mm	119 x 244 x 8 mm		Herstellmaß
strukturiert, matt	strukturiert, matt	strukturiert, matt		strukturiert, matt	strukturiert, matt	reliefiert, matt		Oberfläche
5,556	5,556	2,778		64,000	32,000	32,000		m ² - Stück
17,413	17,413	18,001		15,360	15,680	15,360		m ² - kg
6	6	4		66	33	33		Paket - Stück
1,080	1,080	1,440		1,031	1,031	1,031		Paket - m ²
18,804	18,804	25,920		15,840	16,170	15,840		Paket - kg
43,197	43,197	43,197		86,625	86,625	86,625		Palette - m ²
752,160	752,160	777,600		1.330,560	1.358,280	1.330,560		Palette - kg
Ala	Ala	Ala		Ala	Ala	Ala		Produktnorm
R10/A	R11/B	R10/A		R11/B	R11/B	R11/C		Trittsicherheit
2	2	2		2	2	2		Belastung
8450-B200HK	8460-B200HK	8450-B600HK		8460-32020H	8460-38110H	<i>8460-34090H</i>		basaltgrau <input type="checkbox"/> V4
Preisgr. A124 (m ²)	Preisgr. A142 (m ²)	Preisgr. A136 (m ²)		Preisgr. A157 (m ²)	Preisgr. A127 (m ²)	<i>Preisgr. A148</i> (m ²)		
8451-B200HK	8461-B200HK	8451-B600HK		8461-32020H	8461-38110H	<i>8461-34090H</i>		quarzgrau <input type="checkbox"/> V4
Preisgr. A124 (m ²)	Preisgr. A136 (m ²)	Preisgr. A136 (m ²)		Preisgr. A157 (m ²)	Preisgr. A127 (m ²)	<i>Preisgr. A148</i> (m ²)		
8452-B200HK	8462-B200HK	8452-B600HK		8462-32020H	8462-38110H	<i>8462-34090H</i>		sandbeige <input type="checkbox"/> V4
Preisgr. A124 (m ²)	Preisgr. A142 (m ²)	Preisgr. A136 (m ²)		Preisgr. A157 (m ²)	Preisgr. A127 (m ²)	<i>Preisgr. A148</i> (m ²)		
8453-B200HK	8463-B200HK	8453-B600HK		8463-32020H	8463-38110H	<i>8463-34090H</i>		sepiabraun <input type="checkbox"/> V4
Preisgr. A124 (m ²)	Preisgr. A142 (m ²)	Preisgr. A136 (m ²)		Preisgr. A157 (m ²)	Preisgr. A127 (m ²)	<i>Preisgr. A148</i> (m ²)		
8454-B200HK	8464-B200HK	8454-B600HK		8464-32020H	8464-38110H	<i>8464-34090H</i>		weißgrau <input type="checkbox"/> V4
Preisgr. A124 (m ²)	Preisgr. A142 (m ²)	Preisgr. A136 (m ²)		Preisgr. A157 (m ²)	Preisgr. A127 (m ²)	<i>Preisgr. A148</i> (m ²)		

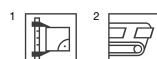

³ Lieferung als Doppelfliesen, müssen örtlich gebrochen werden.

⁴ Verklebung rückseitig auf Glasfasernetz

Treppenfliese mit Schräge^{2/3/5}

31 x 145 cm



Setzstufe^{2/3/5}

28 x 145 cm



Sockel, geschnitten¹

6 x 50 cm



6 x 60 cm



Hohlkehlssockel, dekoriert^{1/2/6/10}

10 x 60 cm



Schriftplatte 1/2/4

25 x 50 cm



Schrifthöhe 7 cm

Formatnummer	B773HK	B774HK	342557HK	B611HK	B612HK	342555HK
Nennmaß - cm/in	31 x 145 / 12 3/8 x 58	28 x 145 / 11 3/16 x 58	6 x 50 / 2 3/8 x 20	6 x 60 / 2 3/8 x 24	10 x 60 / 4 x 24	25 x 50 / 10 x 20
Herstellmaß	307 x 1447 x 10,5 mm	280 x 1447 x 10,5 mm	60 x 497 x 8 mm	60 x 597 x 8 mm	100 x 597/35 x 9 mm	247 x 497 x 8 mm
Oberfläche	strukturiert, matt	strukturiert, matt	strukturiert, matt	strukturiert, matt	strukturiert, matt	strukturiert, matt
m - Stück	0,690	0,690	2,000	1,667	1,667	2
St./m - kg	7,480/m	6,716/m	1,098/m	1,100/m	2,000/m	2,130/Stück
Paket - Stück	2	2	30	34	20	
Paket - m	2,899	2,899	15,000	20,396	11,998	
Paket - kg	21,682	19,466	16,470	22,440	24,000	
Palette - m						
Palette - kg						
Produktnorm	Ala	Ala	Ala	Ala	Alb	Ala
Trittsicherheit	R10/A	R10/A			R10/A	R11/B
Belastung	2	2				2
basaltgrau	8450-B773HK Preisgr. A560 (St.)	8450-B774HK Preisgr. A528 (St.)	8450-342557HK Preisgr. A434 (St.)	8450-B611HK Preisgr. A434 (St.)	8450-B612HK ⁷ Preisgr. A445 (St.)	900725-342555HK Preisgr. A668 (St.)
quarzgrau	8451-B773HK Preisgr. A560 (St.)	8451-B774HK Preisgr. A528 (St.)	8451-342557HK Preisgr. A434 (St.)	8451-B611HK Preisgr. A434 (St.)	8451-B612HK ⁸ Preisgr. A445 (St.)	900726-342555HK Preisgr. A668 (St.)
sandbeige	8452-B773HK Preisgr. A560 (St.)	8452-B774HK Preisgr. A528 (St.)	8452-342557HK Preisgr. A434 (St.)	8452-B611HK Preisgr. A434 (St.)	8452-B612HK ⁸ Preisgr. A445 (St.)	900713-342555HK Preisgr. A668 (St.)
sepiabraun	8453-B773HK Preisgr. A560 (St.)	8453-B774HK Preisgr. A528 (St.)	8453-342557HK Preisgr. A434 (St.)	8453-B611HK Preisgr. A434 (St.)	8453-B612HK ⁸ Preisgr. A445 (St.)	900714-342555HK Preisgr. A668 (St.)
weißgrau	8454-B773HK Preisgr. A560 (St.)	8454-B774HK Preisgr. A528 (St.)	8454-342557HK Preisgr. A434 (St.)	8454-B611HK Preisgr. A434 (St.)	8454-B612HK ⁹ Preisgr. A445 (St.)	900719-342555HK Preisgr. A668 (St.)



³ Nur an den zwei kurzen Seiten rektifiziert. Längsseite kann nicht rektifiziert werden.

⁴ Nur Ziffern/Buchstaben machbar.

Farbkombination:

Grundfarbe: basaltgrau, quarzgrau, sandbeige, sepiabraun, Schriftfarbe: aktivweiß / neutral 10.

Grundfarbe: weißgrau, Schriftfarbe: tiefschwarz/neutral 1.

⁵ Details siehe S. 538. Weitere Lösungen zu Treppenausführungen siehe Serie Area Pro

⁶ Detailzeichnungen Hohlkehlssockel siehe S. 536

⁷ Beanspruchungsgruppe: 2

⁸ Beanspruchungsgruppe: 3

⁹ Beanspruchungsgruppe: 4

¹⁰ Produktionsbedingte Farbabweichungen zum angrenzenden Belag bei liegender Verlegung sind nicht reklamationfähig

Terrassenplatten^{1/4}

60 x 60 cm

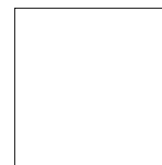

Formatnummer	Nennmaß - cm/in	Herstellmaß - mm	Oberfläche	m ² - Stück	m ² - kg	Paket - Stück	Paket - m ²	Paket - kg	Palette - m ²	Palette - kg	Produktnorm	Trittsicherheit	Belastung	
61061HK	60 x 60 / 24 x 24	597 x 597 x 20 mm	strukturiert, matt	2,778	43,059	1	0,360	15,500	17,279	744,000	Alla	R11/B	3	
8460-61061HK													4	
Preisgr. A220 (m ²)													basaltgrau	V4
8461-61061HK													4	
Preisgr. A220 (m ²)													quarzgrau	V4
8462-61061HK													4	
Preisgr. A220 (m ²)													sandbeige	V4



Flachrinnensystem^{2/3/6} (Muldentiefe 5 mm)

50 x 25 cm



50 x 25 cm⁵

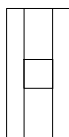

50 x 25 cm

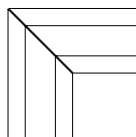

50 x 25 cm⁵

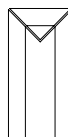

50 x 25 cm

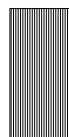

25 x 25 cm



12,5 x 25 cm



Flachrinne	Flachrinne mit Ablauf 110 / 110 mm	Flachrinne Gehrungspaar	Flachrinne Endstück	50 x 25 cm	25 x 25 cm	12,5 x 25 cm	Formatnummer	Nennmaß - cm/in	Herstellmaß - mm	Oberfläche	m - Stück	St./Paar - kg	Paket - St./Paar	Paket - m	Paket - kg	Palette - m	Palette - kg	Produktnorm	Trittsicherheit
53320	53321	53322	53323	53151	53150	53159													
50 x 25 / 20 x 10	50 x 25 / 20 x 10	50 x 25 / 20 x 10	50 x 25 / 20 x 10	50 x 25 / 20 x 10	25 x 25 / 10 x 10	12,5 x 25 / 5 x 10													
494 x 244 x 14	494 x 244 x 14	(2x) 490 x 244 x 14	494 x 244 x 14	494 x 244 x 12,5	244 x 244 x 12,5	119 x 244 x 12,5													
strukturiert, matt	strukturiert, matt	strukturiert, matt	strukturiert, matt	gerillt, matt	gerillt, matt	gerillt, matt													
2,000	2,000	2,000	2,000	2,000	4,000	8,000													
2,500/Stück	2,300/Stück	3,800/Paar	2,500/Stück	3,550/Stück	1,775/Stück	0,888/Stück													
5 Stück	5 Stück	2 Paar	5 Stück	6 Stück	9 Stück	21 Stück													
2,500	2,500	7,600	12,500	3,000	2,250	2,625													
12,500	11,500	7,600	12,500	21,300	15,975	18,648													
Ala	Ala	Ala	Ala	Ala	Ala	Ala													
R11/B	R11/B	R11/B	R11/B	R11/C	R11/C	R11/C													
8460-53320H	8460-53321H	8460-53322H	8460-53323H	8460-53151	8460-53150	8460-53159													
Preisgr. A519 (St.)	Preisgr. A593 (St.)	Preisgr. A645 (Paar)	Preisgr. A593 (St.)	Preisgr. A560 (St.)	Preisgr. A480 (St.)	Preisgr. A430 (St.)													
8461-53320H	8461-53321H	8461-53322H	8461-53323H	8461-53151	8461-53150	8461-53159													
Preisgr. A519 (St.)	Preisgr. A593 (St.)	Preisgr. A645 (Paar)	Preisgr. A593 (St.)	Preisgr. A560 (St.)	Preisgr. A480 (St.)	Preisgr. A430 (St.)													
8462-53320H	8462-53321H	8462-53322H	8462-53323H	8462-53151	8462-53150	8462-53159													
Preisgr. A519 (St.)	Preisgr. A593 (St.)	Preisgr. A645 (Paar)	Preisgr. A593 (St.)	Preisgr. A560 (St.)	Preisgr. A480 (St.)	Preisgr. A430 (St.)													
8463-53320H	8463-53321H	8463-53322H	8463-53323H	8463-53151	8463-53150	8463-53159													
Preisgr. A519 (St.)	Preisgr. A593 (St.)	Preisgr. A645 (Paar)	Preisgr. A593 (St.)	Preisgr. A560 (St.)	Preisgr. A480 (St.)	Preisgr. A430 (St.)													
8464-53320H	8464-53321H	8464-53322H	8464-53323H	8464-53151	8464-53150	8464-53159													
Preisgr. A519 (St.)	Preisgr. A593 (St.)	Preisgr. A645 (Paar)	Preisgr. A593 (St.)	Preisgr. A560 (St.)	Preisgr. A480 (St.)	Preisgr. A430 (St.)													

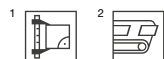

³ Auf Anfrage auch in 497 mm Länge erhältlich.
⁴ Hohes Gewicht! Karton bitte nur zu Zweit transportieren!
⁵ Mindestabnahmemenge 10 Stück. Unter 10 Stück muss der Preis individuell kalkuliert werden.
⁶ Kopfkante rektifiziert

Weitere Details zum Flachrinnensystem und Rillenplatten im Lieferprogramm Pool+Spa.





Elegant und zeitlos

Strukturen und Farben verschiedener Gesteine aus der italienischen Küstenregion „Cinque Terre“ verschmelzen in der Bodenfliesenserie Savona zu einer lebendigen Komposition aus grobkörniger Maserung und weichen Schichtungen. Fein dosierter Granulatauftrag verleiht der Oberfläche eine angenehm steinige Optik und Haptik. Glimmerartige Glanzpunkte unterstreichen die natürliche Wirkung.

Studioaufnahme / Architekt: VSBL, Belgrad, Serbien /
Foto: Jochen Stüber



kalk



beige

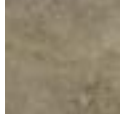

braun



grau



anthrazit



Bodenfliese 15 x 15 cm
strukturiert, R11/C



Bodenfliese 30 x 60 cm, strukturiert, R10/A
Bodenfliese 30 x 60 cm, strukturiert, R11/B



Bodenfliese 60 x 60 cm, strukturiert, R10/A
Bodenfliese 60 x 60 cm, strukturiert, R11/B



Sockel, geschnitten 6 x 6 cm, strukturiert

Mosaik 5 x 5 cm



Mosaikbogen 30 x 30 cm
strukturiert, R11/B



Bodenfliese 60 x 120 cm, strukturiert, R10/A

Mosaik^{1/2}

Bodenfliesen

5 x 5 cm



15 x 15 cm



30 x 60 cm¹



30 x 60 cm¹



60 x 60 cm¹

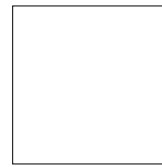

60 x 60 cm¹

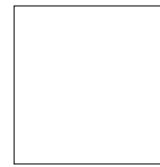

60 x 120 cm^{1/3}

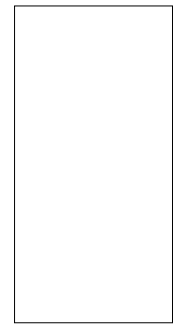

Bogen: 297 x 297 mm

Formatnummer	7161H	342030H	B200HK	B200HK	B600HK	B600HK	B670HK
Nennmaß - cm/in	5 x 5 / 2 x 2	15 x 15 / 6 x 6	30 x 60 / 12 x 24	30 x 60 / 12 x 24	60 x 60 / 24 x 24	60 x 60 / 24 x 24	60 x 120 / 24 x 48
Herstellmaß	47 x 47 x 8 mm	147 x 147 x 8 mm	297 x 597 x 8 mm	297 x 597 x 8 mm	597 x 597 x 8 mm	597 x 597 x 8 mm	597 x 1197 x 8 mm
Oberfläche	strukturiert, matt	strukturiert, matt	strukturiert, matt	strukturiert, matt	strukturiert, matt	strukturiert, matt	strukturiert, matt
m ² - Stück	11,111	44,444	5,556	5,556	2,778	2,778	1,388
m ² - kg	16,389	17,555	17,413	17,413	18,001	18,001	17,489
Paket - Stück	14	35	6	6	4	4	2
Paket - m ²	1,260	0,788	1,080	1,080	1,440	1,440	1,441
Paket - kg	20,650	13,825	18,804	18,804	25,920	25,920	25,200
Palette - m ²	37,800	63,001	43,197	43,197	43,197	43,197	36,023
Palette - kg	619,500	1.106,000	752,160	752,160	777,600	777,600	630,000
Produktnorm	Ala	Bla	Ala	Ala	Ala	Ala	Ala
Trittsicherheit	R11/B	R11/C	R10/A	R11/B	R10/A	R11/B	R10/A
Belastung	2	2	2	2	2	2	2
kalk	8810-7161H Preisgr. A289 (m ²)	8810-342030H Preisgr. A157 (m ²)	8800-B200HK Preisgr. A124 (m ²)	8810-B200HK Preisgr. A142 (m ²)	8800-B600HK Preisgr. A136 (m ²)	8810-B600HK Preisgr. A151 (m ²)	8800-B670HK Preisgr. A166 (m ²)
beige	8811-7161H Preisgr. A289 (m ²)	8811-342030H Preisgr. A157 (m ²)	8801-B200HK Preisgr. A124 (m ²)	8811-B200HK Preisgr. A142 (m ²)	8801-B600HK Preisgr. A136 (m ²)	8811-B600HK Preisgr. A151 (m ²)	8801-B670HK Preisgr. A166 (m ²)
braun	8812-7161H Preisgr. A289 (m ²)	8812-342030H Preisgr. A157 (m ²)	8802-B200HK Preisgr. A124 (m ²)	8812-B200HK Preisgr. A142 (m ²)	8802-B600HK Preisgr. A136 (m ²)	8812-B600HK Preisgr. A151 (m ²)	8802-B670HK Preisgr. A166 (m ²)
grau	8813-7161H Preisgr. A289 (m ²)	8813-342030H Preisgr. A157 (m ²)	8803-B200HK Preisgr. A124 (m ²)	8813-B200HK Preisgr. A142 (m ²)	8803-B600HK Preisgr. A136 (m ²)	8813-B600HK Preisgr. A151 (m ²)	8803-B670HK Preisgr. A166 (m ²)
anthrazit	8814-7161H Preisgr. A289 (m ²)	8814-342030H Preisgr. A157 (m ²)	8804-B200HK Preisgr. A124 (m ²)	8814-B200HK Preisgr. A142 (m ²)	8804-B600HK Preisgr. A136 (m ²)	8814-B600HK Preisgr. A151 (m ²)	8804-B670HK Preisgr. A166 (m ²)



Sockel,
geschnitten¹

6 x 60 cm



Formatnummer	B611HK						
Nennmaß - cm/in	6 x 60 / 2 3/8 x 24						
Herstellmaß	60 x 597 x 8 mm						
Oberfläche	strukturiert, matt						
m - Stück	1,667						
m - kg	1,100						
Paket - Stück	34						
Paket - m	20,396						
Paket - kg	22,440						
Palette - m							
Palette - kg							
Produktnorm	Ala						
kalk	8800-B611HK Preisgr. A434 (St.)						
beige	8801-B611HK Preisgr. A434 (St.)						
braun	8802-B611HK Preisgr. A434 (St.)						
grau	8803-B611HK Preisgr. A434 (St.)						
anthrazit	8804-B611HK Preisgr. A434 (St.)						



¹ Verklebung rückseitig auf Glasfasernetz

³ Hohes Gewicht! Karton bitte nur zu Zweit transportieren!

Studioaufnahme / Architekt: VSBL, Belgrad, Serbien / Foto: Jochen Stüber







Zeitgeist meets zeitlos

Die Keramikfliesen-Serie Senja Pure gibt Bädern und privaten Wellnessbereichen einen wohnlichen Touch und eine warme, lebendige Anmutung. Ihre naturnahen Farbtöne und sanft strukturierten Oberflächen sind trendy und gleichzeitig zeitlos schön. Das Ergebnis: Harmonisch aufeinander abgestimmte Räume im klaren Vintage Style, im wohltuend zurückhaltenden Nordic Design oder im Shabby-Chic-Style. Die erfolgreiche Kollektion wurde um die kräftige Farbe Shabby-Chic-Brown und um großformatige naturweiße Wandfliesen erweitert – das bietet noch mehr Spielraum für Gestaltung.

Rendering



Mosaik 2,5 x 2,5 cm



Mosaikbogen 30 x 30 cm,
ahorn, strukturiert
Mosaikbogen 30 x 30 cm,
ahorn, strukturiert, R10/B

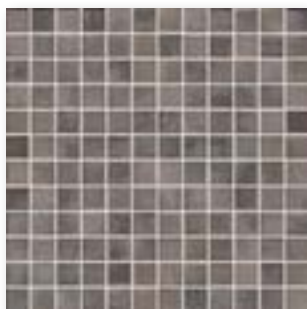

Mosaikbogen 30 x 30 cm,
shabby chic brown, strukturiert
Mosaikbogen 30 x 30 cm,
shabby chic brown, strukturiert, R10/B

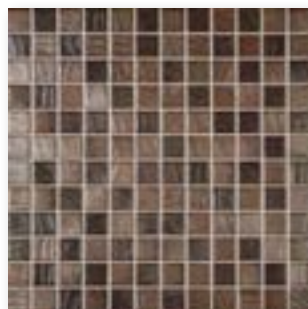

Mosaikbogen 30 x 30 cm,
wenge-metallic, strukturiert

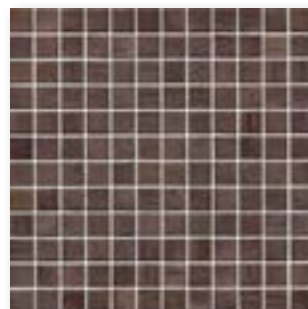

Mosaikbogen 30 x 30 cm,
wenge, strukturiert
Mosaikbogen 30 x 30 cm,
wenge, strukturiert, R10/B



Mosaikbogen 30 x 30 cm,
eiche, strukturiert
Mosaikbogen 30 x 30 cm,
eiche, strukturiert, R10/B



Mosaikbogen 30 x 30 cm,
shabby chic, strukturiert
Mosaikbogen 30 x 30 cm,
shabby chic, strukturiert, R10/B



Mosaikbogen 30 x 30 cm,
wood-mix, strukturiert



Mosaikbogen 30 x 30 cm,
wood-mix metallic, strukturiert



Rückseitig thermoplastisch verklebte Mosaik sind nicht nur im Trockenbereich, sondern auch bedenkenlos im Unterwasserbereich (z. B. Schwimmbecken/ Whirlpool) sowie im dauernassbelasteten Bereich einsetzbar.

Mosaik 5 x 5 cm



Mosaikbogen 30 x 30 cm,
ahorn, strukturiert, R10/B



Mosaikbogen 30 x 30 cm,
shabby chic brown,
strukturiert, R10/B

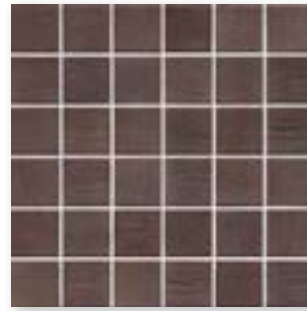

Mosaikbogen 30 x 30 cm,
wenge, strukturiert, R10/B



Mosaikbogen 30 x 30 cm,
eiche, strukturiert, R10/B



Mosaikbogen 30 x 30 cm,
shabby chic, strukturiert, R10/B



Rückseitig thermoplastisch verklebte Mosaik sind nicht nur im Trockenbereich, sondern auch bedenkenlos im Unterwasserbereich (z. B. Schwimmbecken/ Whirlpool) sowie im dauernassbelasteten Bereich einsetzbar.



Wandfliese 30 x 60 cm, naturweiß, eben

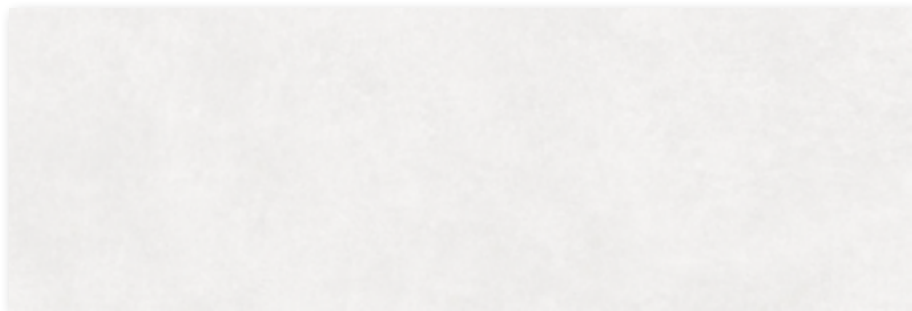

Wandfliese 30 x 90 cm, naturweiß, eben

Wandfliesen⁴

Mosaik¹

30 x 60 cm

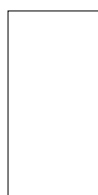

30 x 90 cm²



2,5 x 2,5 cm

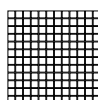

2,5 x 2,5 cm

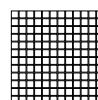

5 x 5 cm

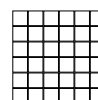

		30 x 60 / 12 x 24	30 x 90 / 12 x 36	2,5 x 2,5 / 1 x 1	2,5 x 2,5 / 1 x 1	5 x 5 / 2 x 2	
		297 x 597 x 6 mm	297 x 897 x 6 mm	23 x 23 x 6,5 mm	23 x 23 x 6,5 mm	47 x 47 x 6,5 mm	Nennmaß - cm/in
		eben, seidenmatt	eben, seidenmatt	strukturiert, matt	strukturiert, matt	strukturiert, matt	Herstellmaß
		5,556	3,704	11 Bögen	11 Bögen	11 Bögen	Oberfläche
		10,279	10,400	12,100	12,100	12,331	m ² - Stück
		13	8	11 Bögen	11 Bögen	11 Bögen	m ² - kg
		2,340	2,160	1,000	1,000	1,000	Paket - Stück
		24,050	22,464	12,100	12,100	12,331	Paket - m ²
		112,311	51,836	48,000	48,000	64,000	Paket - kg
		1.154,400	539,136	580,800	580,800	789,184	Palette - m ²
		BIII	BIII	Blb	Blb	Blb	Palette - kg
				R10/B	R10/B	R10/B	Produktnorm
				1	1	1	Trittsicherheit
							Belastung
		203331H	323332H				naturweiß <input type="checkbox"/> V1
		Preisgr. W90 (m ²)	Preisgr. W111 (m ²)				
				3221H	3201H	3251H	4
				Preisgr. W288 (m ²)	Preisgr. W303 (m ²)	Preisgr. W240 (m ²)	ahorn <input type="checkbox"/> V2
				3222H	3206H	3252H	3
				Preisgr. W288 (m ²)	Preisgr. W303 (m ²)	Preisgr. W240 (m ²)	shabby chic brown <input type="checkbox"/> V3
				3227^{3/5}			2
				Preisgr. W323 (m ²)			wenge-metallic <input type="checkbox"/> V2
				3228H	3202H	3258H	2
				Preisgr. W288 (m ²)	Preisgr. W303 (m ²)	Preisgr. W240 (m ²)	wenge <input type="checkbox"/> V2
				3303H	3203H	3353H	4
				Preisgr. W288 (m ²)	Preisgr. W303 (m ²)	Preisgr. W240 (m ²)	eiche <input type="checkbox"/> V2
				3304H	3314H	3354H	4
				Preisgr. W288 (m ²)	Preisgr. W303 (m ²)	Preisgr. W240 (m ²)	shabby chic <input type="checkbox"/> V3
				3305H			4
				Preisgr. W303 (m ²)			wood-mix <input type="checkbox"/> V4
				3306^{3/5}			1
				Preisgr. W323 (m ²)			wood-mix metallic <input type="checkbox"/> V4



³ Nicht oder nur bedingt säure- und laugenbeständig.

⁴ Nicht frostsicher

⁵ ohne Hytect-Veredelung







Mix aus Beton, Ornamenten und Farben

Schon das Basis Design der Serie Sento überzeugt mit seiner modernen Betonoptik. Und es lässt sich wunderbar mit den feinen floralen Ornamenten des Blossom Dekors verbinden. Wer mehr Kontrast wünscht, verbindet die Betonoptik einfach mit dem leuchtend, farbigen Stäbchenmosaik. Alle Fliesen dieser Serie – mit Ausnahme des Stripe Dekors – sind Hytect-veredelt.

Rendering



Wandfliese 30 x 60 cm, pale white, strukturiert



Wandfliese 35 x 100 cm, pale white, strukturiert

Dekorationselemente



Dekorfliese Blossom 30 x 60 cm, beige grey, strukturiert



Dekorfliese Blossom 35 x 100 cm, beige grey, strukturiert



Dekorationselemente



Schnittdekor Color Stripe 30 x 30 cm,
sky aqua, strukturiert

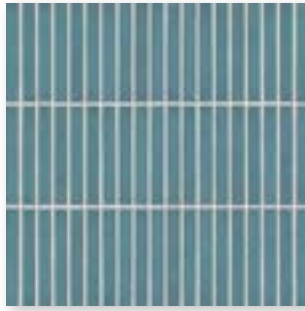

Schnittdekor Color Stripe 30 x 30 cm,
pacific blue, strukturiert

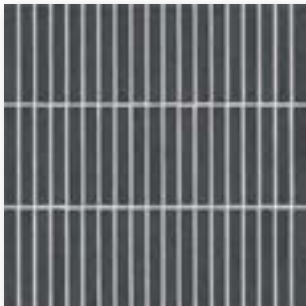

Schnittdekor Color Stripe 30 x 30 cm,
lava black, strukturiert



Schnittdekor Color Stripe 30 x 30 cm,
earth red, strukturiert

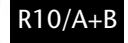
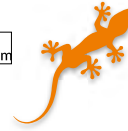

off white



concrete grey



pale mud



dark anthracite



Bodenfliese 30 x 60 cm, strukturiert, R10/A+B



Bodenfliese 60 x 60 cm, strukturiert, R10/A+B



Bodenfliese 60 x 120 cm, strukturiert, R10/A+B



Sockel, geschnitten 7 x 60 cm, strukturiert

Dekorationselemente



Bodendekor Blossom 60 x 60 cm, strukturiert, R10/A+B

Mosaik 5 x 5 cm



Mosaikbogen 30 x 30 cm, off white, strukturiert, R10/A+B



Mosaikbogen 30 x 30 cm, concrete grey, strukturiert, R10/A+B



Mosaikbogen 30 x 30 cm, pale mud strukturiert, R10/A+B

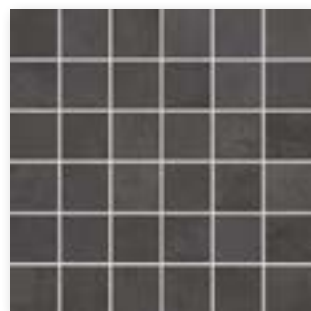

Mosaikbogen 30 x 30 cm, dark anthracite strukturiert, R10/A+B

Mosaik: Verklebung rückseitig auf Glasfasernetz,
Bogen: 297 x 297 mm

Wandfliesen

Dekorationselemente⁶

30 x 60 cm



35 x 100 cm¹

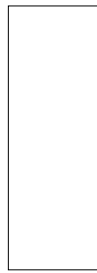

30 x 60 cm

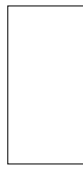

35 x 100 cm¹



30 x 30 cm^{2/3/4/5}



Nennmaß - cm/in	Dekorfliese Blossom		Dekorfliese Blossom		Schnittdekor Color Stripe		
	30 x 60 / 12 x 24	35 x 100 cm / 14 x 40	30 x 60 / 12 x 24	35 x 100 cm / 14 x 40	Bogen; 297 x 297 mm		
Herstellmaß	297 x 597 x 6 mm	347 x 997 x 6 mm	297 x 597 x 6 mm	347 x 997 x 6 mm	297 x 297 x 6,5 mm		
Oberfläche	strukturiert, steinmatt	strukturiert, steinmatt	strukturiert, steinmatt	strukturiert, steinmatt	strukturiert, semi-matt		
m ² /m - Stück	5,556/m ²	2,857/m ²	5,556/m ²	2,857/m ²	3,333/m		
m ² /m - kg	10,279/m ²	10,108/m ²	10,279/m ²	10,108/m ²	3,326/m		
Paket - Stück	13	5	13	5	5		
Paket - m ² /m	2,340 m ²	1,750 m ²	2,340 m ²	1,750 m ²	1,500 m		
Paket - kg	24,050	17,690	24,050	17,690	4,990		
Palette - m ²	112,311	70,004	112,311	70,004			
Palette - kg	1.154,400	707,600	1.154,400	707,600			
Produktnorm	BIII	BIII	BIII	BIII	Bla		
pale white	203412H Preisgr. C77 (m ²)	363414H Preisgr. C143 (m ²)	203413H Preisgr. C89 (m ²)	363415H Preisgr. C149 (m ²)			
beige grey							
sky aqua					203408 Preisgr. C558 (St.)		
pacific blue					203409 Preisgr. C558 (St.)		
lava black					203410 Preisgr. C558 (St.)		
earth red					203411 Preisgr. C558 (St.)		



³ Verklebung rückseitig auf Glasfasernetz
⁴ Nur für die Verlegung an der Wand geeignet
⁵ ohne Hytect-Veredelung
⁶ Abgabe der Dekorationselemente ausschließlich in vollen Kartons.

Mosaik^{1/2}

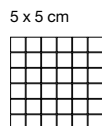

Bodenfliesen¹

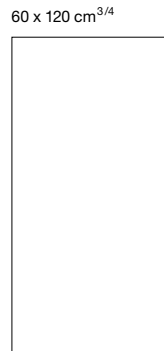
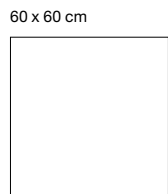

Dekorations-
elemente^{1/5}

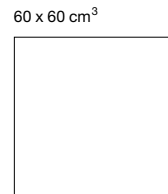

Sockel,
geschnitten¹

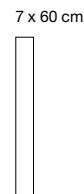

Bogen: 297 x 297 mm

Bodendekor
Blossom



5 x 5 / 2 x 2	30 x 60 / 12 x 24	60 x 60 / 24 x 24	60 x 120 / 24 x 48	60 x 60 / 24 x 24	7 x 60 / 2 13/16 x 24	Nennmaß - cm/in
47 x 47 x 6 mm	297 x 597 x 6 mm	597 x 597 x 6 mm	597 x 1197 x 6 mm	597 x 597 x 6 mm	70 x 597 x 6 mm	Herstellmaß
strukturiert, matt	strukturiert, matt	strukturiert, matt	strukturiert, matt	strukturiert, matt	strukturiert, matt	Oberfläche
11,111 Bögen/m ²	5,556/m ²	2,778/m ²	1,388/m ²	2,778/m ²	1,667/m	m ² /m - Stück
11,488 Bögen/m ²	13,273/m ²	13,581/m ²	14,088/m ²	13,581/m ²	0,938/m	m ² /m - kg
11	10	5	3	5	38	Paket - Stück
0,990 m ²	1,800 m ²	1,800 m ²	2,161 m ²	1,800 m ²	22,795 m	Paket - m ² /m
11,374	23,890	24,445	30,450	24,445	21,394	Paket - kg
35,640	71,994	64,795	75,648	64,795		Palette - m ²
409,464	955,600	880,020	1.065,750	880,020		Palette - kg
Bla	Bla	Bla	Bla	Bla	Bla	Produktnorm
R10/A+B	R10/A+B	R10/A+B	R10/A+B	R10/A+B		Trittsicherheit
1	1	1	1	1		Belastung
431601H	431605H	431609H	431613H		431621H	off white <input type="checkbox"/> V2
Preisgr. C308 (m ²)	Preisgr. C98 (m ²)	Preisgr. C107 (m ²)	Preisgr. C137 (m ²)		Preisgr. C440 (St.)	off white <input type="checkbox"/> V3
				431617H		concrete grey <input type="checkbox"/> V2
				Preisgr. C116 (m ²)		concrete grey <input type="checkbox"/> V3
431602H	431606H	431610H	431614H		431622H	pale mud <input type="checkbox"/> V2
Preisgr. C308 (m ²)	Preisgr. C98 (m ²)	Preisgr. C107 (m ²)	Preisgr. C137 (m ²)		Preisgr. C440 (St.)	pale mud <input type="checkbox"/> V3
				431618H		dark anthracite <input type="checkbox"/> V2
				Preisgr. C116 (m ²)		dark anthracite <input type="checkbox"/> V3
431603H	431607H	431611H	431615H		431623H	
Preisgr. C308 (m ²)	Preisgr. C98 (m ²)	Preisgr. C107 (m ²)	Preisgr. C137 (m ²)		Preisgr. C440 (St.)	
				431619H		
				Preisgr. C116 (m ²)		
431604H	431608H	431612H	431616H		431624H	
Preisgr. C308 (m ²)	Preisgr. C98 (m ²)	Preisgr. C107 (m ²)	Preisgr. C137 (m ²)		Preisgr. C440 (St.)	
				431620H		
				Preisgr. C116 (m ²)		



² Verklebung rückseitig auf Glasfasernetz

³ Achtung: Sonderpalette. Keine Rücknahme, kein Umtausch.

⁴ Hohes Gewicht! Karton bitte nur zu Zweit transportieren.

⁵ Abgabe der Dekorationselemente ausschließlich in vollen Kartons







Ursprünglich und edel

Die Feinsteinzeug-Serie Sierra bringt durch ihre Farben und Oberflächenoptik Ursprünglichkeit und Natürlichkeit in den Wohnraum. Die Farbstellung Hellbeige gibt die Charakteristika von Sandstein authentisch wieder: dezente Farbschichtungen mit typischen Farbverläufen. In der Variante Anthrazit erfahren die Stäbchenmosaiken in unterschiedlichen Formaten und Schnittrichtungen eine stärkere Betonung des Mauerwerkscharakters. Passende Bodenfliesen in den Formaten 5 x 5 cm und 30 x 60 cm sind in den drei Serien-Farben (neben Hellbeige, Anthrazit und Hellgrau) verfügbar. Die Boden- und Treppenfliesen (30 x 60 cm) sind Protecta-vergütet und trittsicher R10/A.

Studioaufnahme



R10/A



anthrazit



hellgrau

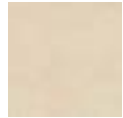

hellbeige



Bodenfliese 30 x 60 cm, strukturiert, R10/A

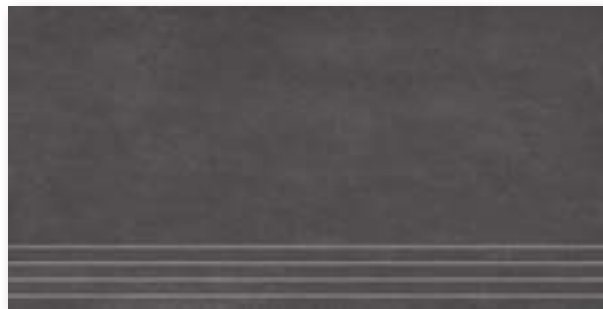

Treppenfliese 30 x 60 cm (rilliert), strukturiert, R10/A



Sockel, gerundet 7 x 60 cm, strukturiert



Mosaik 5 x 5 cm

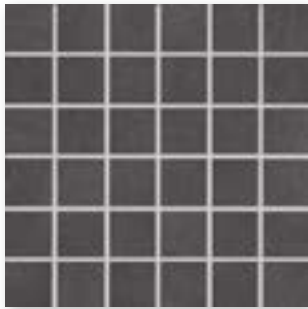

Mosaikbogen 30 x 30 cm, anthrazit, strukturiert, R10/B



Mosaikbogen 30 x 30 cm, hellgrau, strukturiert, R10/B



Mosaikbogen 30 x 30 cm, hellbeige strukturiert, R10/B

Mosaik: Verklebung rückseitig auf Glasfasernetz, Bogen: 297 x 297 mm.

Riegelmosaik

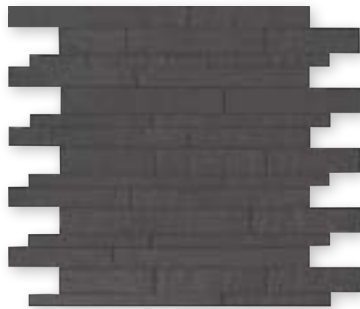

Riegelmosaik 30 x 30 cm, anthrazit, strukturiert, R10/A



Riegelmosaik 30 x 30 cm, hellgrau, strukturiert, R10/A



Riegelmosaik 30 x 30 cm, hellbeige, strukturiert, R10/A

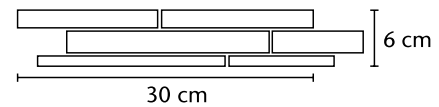

Vorschlag für Bordüregestaltung:
Aus einem Mosaikbogen können fünf Bordüren gemäß beigefügter Skizze entnommen werden = 1,5 lfm.

Riegelmosaik: Verklebung rückseitig auf Glasfasernetz, Bogen: 298 x 298 mm.

Mosaik^{1/3}

5 x 5 cm

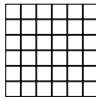

Riegelmosaik³

30 x 30 cm

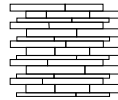

Bodenfliesen¹

30 x 60 cm

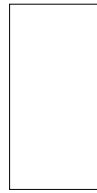

Treppenfliesen^{1/2}

30 x 60 cm

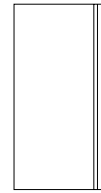

Sockel, gerundet¹

7 x 60 cm¹



protected

Bogen: 297 x 297 mm

Bogen: 298 x 298 mm

Nennmaß - cm/in	5 x 5 / 2 x 2	30 x 30 / 12 x 12	30 x 60 / 12 x 24	30 x 60 / 12 x 24	7 x 60 / 2 13/16 x 24
Herstellmaß	47 x 47 x 9 mm	298 x 298 x 9 mm	297 x 597 x 9 mm	297 x 597 x 9 mm	70 x 597 x 9 mm
Oberfläche	strukturiert, matt	strukturiert, matt	strukturiert, matt	strukturiert, matt	strukturiert, matt
m ² /m - Stück	11,111 Bögen/m ²	11,111 Bögen/m ²	5,556/m ²	1,667/m	1,667/m
m ² /m - kg	19,833/m ²	20,755/m ²	19,907/m ²	5,973/m	1,357/m
Paket - Stück	12 Bögen	12 Bögen	7	7	22
Paket - m ² /m	1,080 m ²	1,080 m ²	1,260 m ²	4,199 m	13,197 m
Paket - kg	21,420	22,416	25,081	25,081	17,908
Palette - m ²	32,400	32,400	50,396		
Palette - kg	642,600	672,480	1.003,240		
Produktnorm	Bla	Bla	Bla	Bla	Bla
Trittsicherheit	R10/B	R10/A	R10/A	R10/A	
Belastung	2	2	2	2	
anthrazit	431380 Preisgr. C314 (m ²)	431386 Preisgr. C377 (m ²)	431383 Preisgr. C98 (m ²)	431389 Preisgr. C474 (St.)	431392 Preisgr. C440 (St.)
hellgrau	431381 Preisgr. C314 (m ²)	431387 Preisgr. C377 (m ²)	431384 Preisgr. C98 (m ²)	431390 Preisgr. C474 (St.)	431393 Preisgr. C440 (St.)
hellbeige	431382 Preisgr. C314 (m ²)	431388 Preisgr. C377 (m ²)	431385 Preisgr. C98 (m ²)	431391 Preisgr. C474 (St.)	431394 Preisgr. C440 (St.)



³ Verklebung rückseitig auf Glasfasernetz

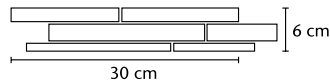

Vorschlag für Bordüregestaltung: Aus einem Mosaikbogen können fünf Bordüren gemäß beigefügter Skizze entnommen werden = 1,5 lfm.

Studioaufnahme







Praktisch im Objekt

Mit einer kompakten Produktpalette bietet die neue Bodenserie Skill eine zweckmäßige Auswahl an Farben und Formaten. Feine Körnungen, sanfte Maserungen und weiche Farbübergänge mit einem zarten Relief prägen das Design. Mit einer Materialstärke von 9 mm sind die Feinsteinzeugfliesen im Format 30 x 60 cm, 60 x 60 cm und dem Großformat 60 x 120 cm für die Verwendung im Objektbau bestens geeignet. Zwei Treppenfliesenformate runden die Serie ab. Alle Fliesen verfügen über Trittsicherheit R10/A+B und sind durch die Hytect-Veredelung besonders pflegeleicht.

Rendering



R10/A+B



dark taupe



light sand



warm grey



dark anthracite



Bodenfliese 30 x 60 cm, strukturiert, R10/A+B



Bodenfliese 60 x 60 cm, strukturiert, R10/A+B

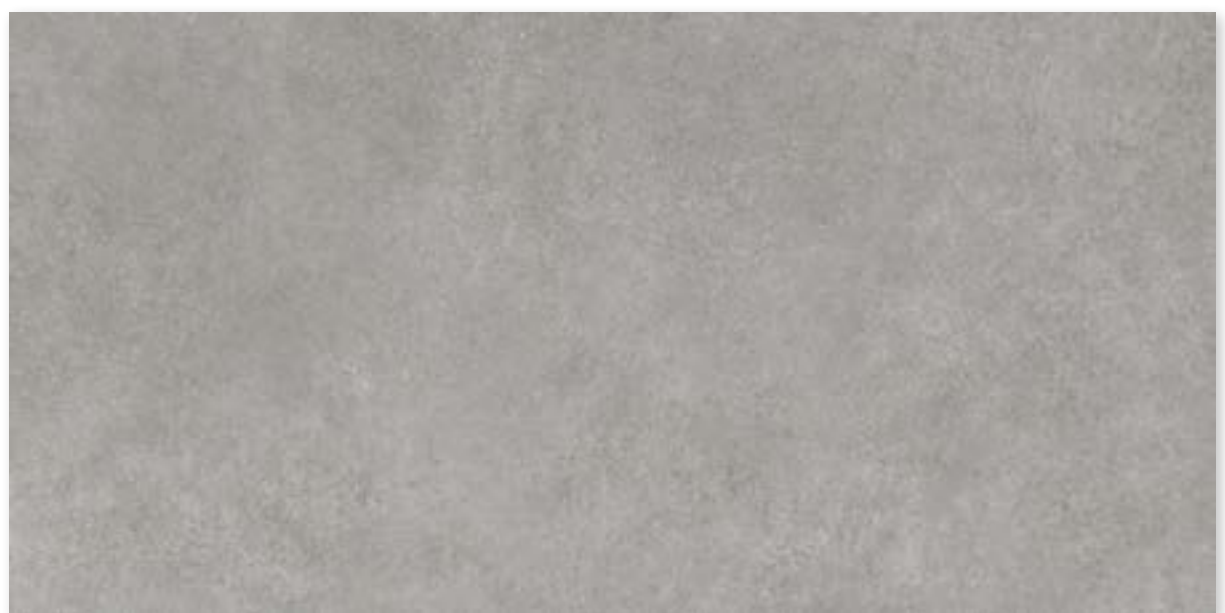

Bodenfliese 60 x 120 cm, strukturiert, R10/A+B

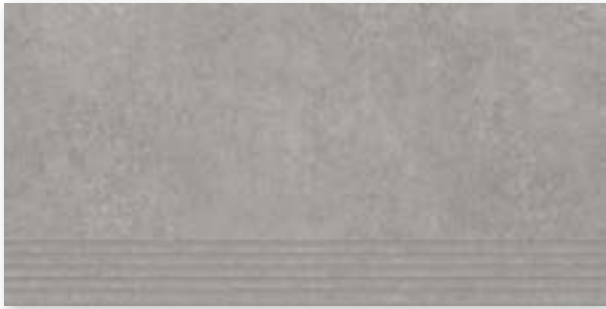

Treppenfliese 30 x 60 cm (rilliert), strukturiert, R10/A+B



Treppenfliese 30 x 120 cm (rilliert), strukturiert, R10/A+B



Sockel, geschnitten 7 x 60 cm, strukturiert

Bodenfliesen¹

Treppenfliesen^{1/2}

Sockel,
geschnitten¹

30 x 60 cm



60 x 60 cm

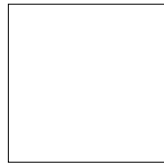

60 x 120 cm^{3/4}



30 x 60 cm



30 x 120 cm



7 x 60 cm



Nennmaß - cm/in	30 x 60 / 12 x 24	60 x 60 / 24 x 24	60 x 120 / 24 x 48	30 x 60 / 12 x 24	30 x 120 / 12 x 48	7 x 60 / 2 13/16 x 24
Herstellmaß	297 x 597 x 9 mm	597 x 597 x 9 mm	597 x 1197 x 9 mm	297 x 597 x 9 mm	297 x 1197 x 9 mm	70 x 597 x 9 mm
Oberfläche	strukturiert, matt	strukturiert, matt	strukturiert, matt	strukturiert, matt	strukturiert, matt	strukturiert, matt
m ² /m - Stück	5,556/m ²	2,778/m ²	1,388/m ²	1,667/m	0,833/m	1,667/m
m ² /m - kg	19,907/m ²	20,371/m ²	21,132/m ²	5,973/m	6,341/m	1,357/m
Paket - Stück	7	3	2	7	3	26
Paket - m ² /m	1,260 m ²	1,080 m ²	1,441 m ²	4,199 m	3,601 m	8,998 m
Paket - kg	25,081	21,999	30,450	25,081	22,836	21,164
Palette - m ²	50,396	45,356	50,432			
Palette - kg	1.003,240	923,958	1.065,750			
Produktnorm	Bla	Bla	Bla	Bla	Bla	Bla
Trittsicherheit	R10/A+B	R10/A+B	R10/A+B	R10/A+B	R10/A+B	
Belastung	2	2	2	2	2	
dark taupe 	431352H Preisgr. A94 (m ²)	431356H Preisgr. A106 (m ²)	431363H Preisgr. A142 (m ²)	<i>431367H</i> <i>Preisgr. A456 (St.)</i>	<i>431371H</i> <i>Preisgr. A522 (St.)</i>	431395H Preisgr. A438 (St.)
light sand 	431353H Preisgr. A94 (m ²)	431357H Preisgr. A106 (m ²)	431364H Preisgr. A142 (m ²)	<i>431368H</i> <i>Preisgr. A456 (St.)</i>	<i>431372H</i> <i>Preisgr. A522 (St.)</i>	431396H Preisgr. A438 (St.)
warm grey 	431354H Preisgr. A94 (m ²)	431358H Preisgr. A106 (m ²)	431365H Preisgr. A142 (m ²)	<i>431369H</i> <i>Preisgr. A456 (St.)</i>	<i>431373H</i> <i>Preisgr. A522 (St.)</i>	431397H Preisgr. A438 (St.)
dark anthracite 	431355H Preisgr. A94 (m ²)	431359H Preisgr. A106 (m ²)	431366H Preisgr. A142 (m ²)	<i>431370H</i> <i>Preisgr. A456 (St.)</i>	<i>431374H</i> <i>Preisgr. A522 (St.)</i>	431398H Preisgr. A438 (St.)



³ Achtung: Sonderpalette. Keine Rücknahme, kein Umtausch.
⁴ Hohes Gewicht! Karton bitte nur zu Zweit transportieren.

Rendering







Kunst im Raum

Die Serie Solid Ground, in Zusammenarbeit mit dem Architektenbüro Hadi Teherani, vereint Beton und Travertin zu einem harmonischen Design, das Stabilität und Eleganz ausstrahlt. Die Serie bietet kreative Freiheit mit modernen Farben und einem modularen Formatbaukasten. Ein Highlight sind Treppenfliesen in Travertin-Optik mit 145 cm Länge. Solid Ground ermöglicht vielfältige und edle Gestaltungsmöglichkeiten für Wohnräume, Büros, Hotels und Ladenflächen, perfekt für Architekten, Planer und Bauherren.

Rendering / Architekt: Hadi Teherani

Dekorationselemente



Wandfliese 30 x 60 cm, natural white, eben

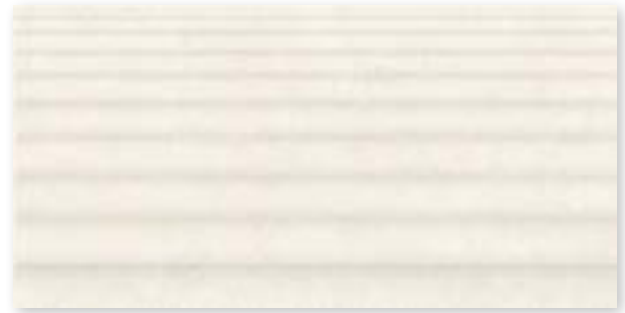

Dekorfliese 30 x 60 cm, natural white, reliefiert



Wandfliese 30 x 60 cm, grey green, eben



Dekorfliese 30 x 60 cm, grey green, reliefiert



Wandfliese 30 x 60 cm, belgish grey, eben



Dekorfliese 30 x 60 cm, belgish grey, reliefiert



R10/A+B



Concrete



sand white

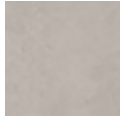

umber grey

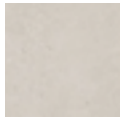

warm grey



red clay

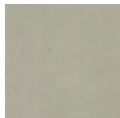

mud green

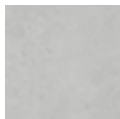

light grey

Travertine



italian white



belgish grey



urban grey



persian red

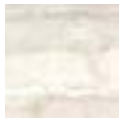

beach white



nordic grey

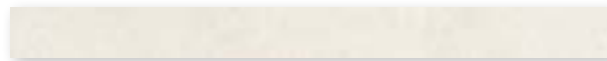

Bodenfliese 5 x 60 cm, strukturiert, R10/A+B



Bodenfliese 15 x 60 cm, strukturiert, R10/A+B (nur in Concrete erhältlich)



Bodenfliese 30 x 60 cm, strukturiert, R10/A+B
Bodenfliese 30 x 60 cm, eben, R10/A+B



Bodenfliese 60 x 60 cm, strukturiert, R10/A+B (nur in Concrete erhältlich)



R10/A+B



Travertine



italian white



belgish grey



urban grey



persian red

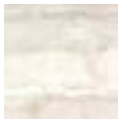

beach white



nordic grey



Bodenfliese 60 x 120 cm, eben, R10/A+B (nur in Travertine erhältlich)



Concrete

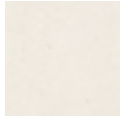

sand white

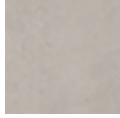

umber grey

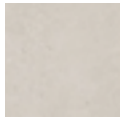

warm grey



light grey

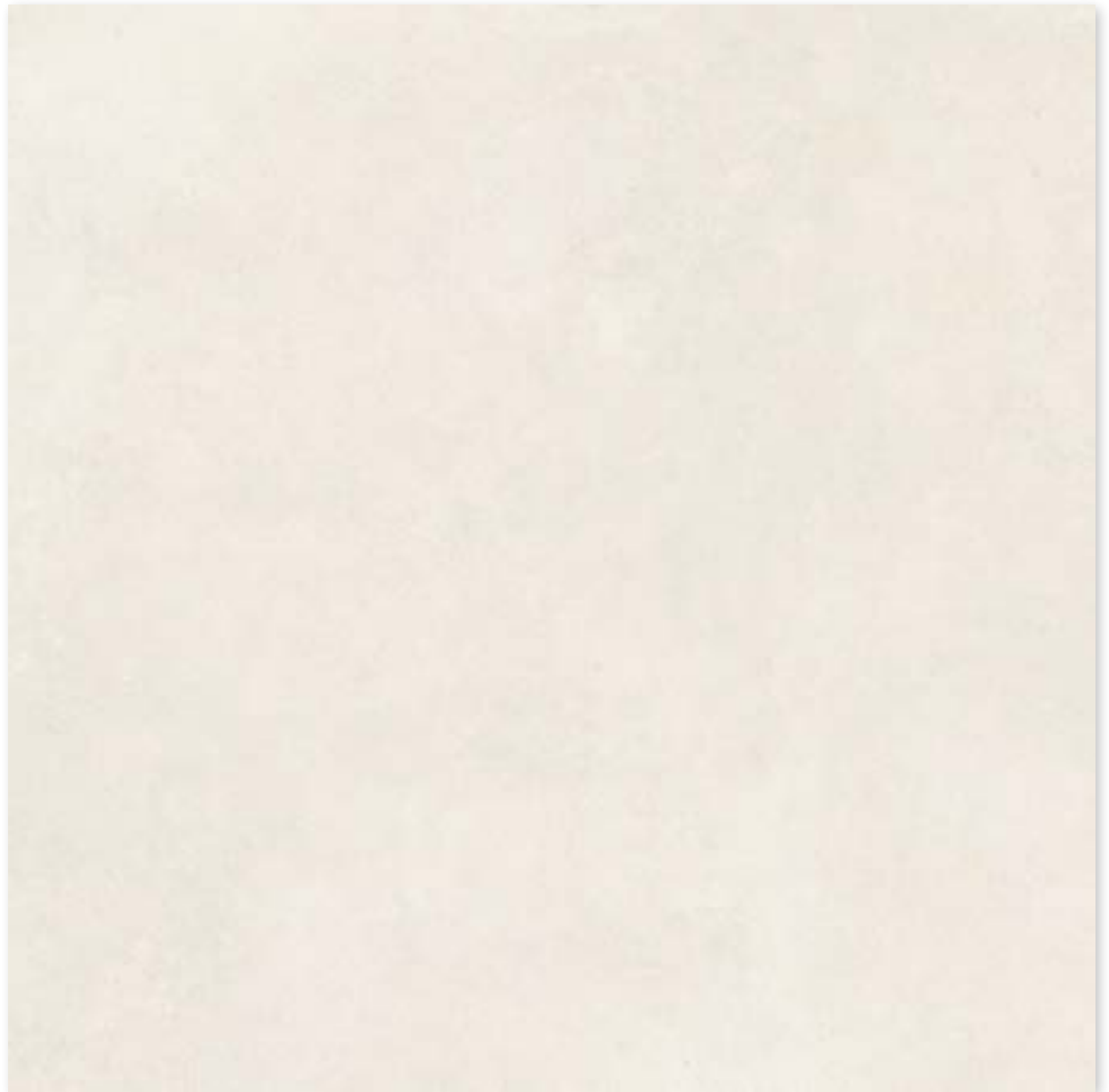

Bodenfliese 120 x 120 cm, strukturiert, R10/A+B (nur in Concrete erhältlich)



Concrete



sand white

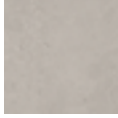

umber grey

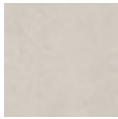

warm grey

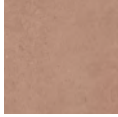

red clay



mud green



light grey

Travertine



italian white



belgish grey



urban grey



persian red

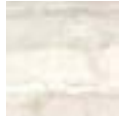

beach white



nordic grey



Treppenfliese 30 x 60 cm (rilliert), strukturiert, R10/A+B
 Treppenfliese 30 x 60 cm (rilliert), eben, R10/A+B

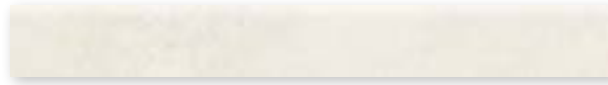

Sockel, gerundet 7 x 60 cm, strukturiert
 Sockel, gerundet 7 x 60 cm, eben



Treppenfliese mit Schräge 31 x 145 cm, eben, R10/A+B (nur in Travertine erhältlich)



Setzstufe 28 x 145 cm, eben, R10/A+B (nur in Travertine erhältlich)



R10/A+B



Mosaik 5 x 15

Concrete



Mosaikbogen 30 x 30 cm
sand white, eben, R10/A+B



Mosaikbogen 30 x 30 cm
umber grey, eben, R10/A+B



Mosaikbogen 30 x 30 cm
warm grey, eben, R10/A+B

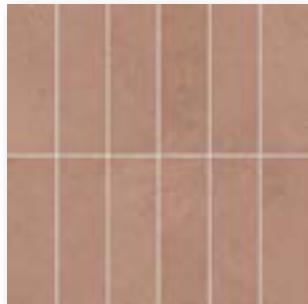

Mosaikbogen 30 x 30 cm
red clay, eben, R10/A+B



Mosaikbogen 30 x 30 cm
mud green, eben, R10/A+B



Mosaikbogen 30 x 30 cm
light grey, eben, R10/A+B

Travertine



Mosaikbogen 30 x 30 cm
italian white, eben, R10/A+B



Mosaikbogen 30 x 30 cm
belgish grey, eben, R10/A+B



Mosaikbogen 30 x 30 cm
urban grey, eben, R10/A+B

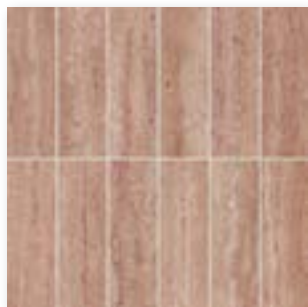

Mosaikbogen 30 x 30 cm
persian red, eben, R10/A+B



Mosaikbogen 30 x 30 cm
beach white, eben, R10/A+B



Mosaikbogen 30 x 30 cm
nordic grey, eben, R10/A+B

Mosaik: Verklebung rückseitig auf Glasfasernetz,
Bogen: 297 x 297 mm.

Wandfliese²

**Dekorations-
elemente**

Bodenfliesen¹

30 x 60 cm



30 x 60 cm

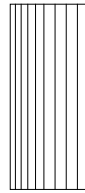

5 x 60 cm



5 x 60 cm



15 x 60 cm

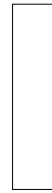

30 x 60 cm



30 x 60 cm

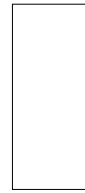

	Concrete	Concrete	Concrete	Travertine	Concrete	Concrete	Travertine
Nennmaß - cm/in	30 x 60 / 12 x 24	30 x 60 / 12 x 24	5 x 60 / 2 x 24	5 x 60 / 2 x 24	15 x 60 / 6 x 24	30 x 60 / 12 x 24	30 x 60 / 12 x 24
Herstellmaß	297 x 597 x 6 mm	297 x 597 x 6 mm	47 x 597 x 9 mm	47 x 597 x 9 mm	147 x 597 x 9 mm	297 x 597 x 9 mm	297 x 597 x 9 mm
Oberfläche	eben, steinmatt	reliefiert, steinmatt	strukturiert, matt	eben, matt	strukturiert, matt	strukturiert, matt	strukturiert, matt
m ² - Stück	5,556	5,556	33,333	33,333	11,111	5,556/m ²	5,556/m ²
m ² - kg	10,279	10,279	6,633	6,633	19,900	19,907/m ²	19,907/m ²
Paket - Stück	13	13	39	39	13	7	7
Paket - m ²	2,340	2,340	1,180	1,180	1,170	1,260 m ²	1,260 m ²
Paket - kg	24,050	24,050	23,283	23,283	23,283	25,081	25,081
Palette - m ²	112,311	112,311	46,800	46,800	46,800	50,396	50,396
Palette - kg	1.154,400	1.154,400	931,320	931,320	931,311	1.003,240	1.003,240
Produktnorm	BIII	BIII	Bla	Bla	Bla	Bla	Bla
Trittsicherheit			R10/A+B	R10/A+B	R10/A+B	R10/A+B	R10/A+B
Belastung			2	2	2	2	2
natural white <input type="checkbox"/>	203505H Preisgr. C107 (m ²)	203506H Preisgr. C116 (m ²)					
grey green <input type="checkbox"/>	203507H Preisgr. C107 (m ²)	203508H Preisgr. C116 (m ²)					
belgish grey <input type="checkbox"/>	203509H Preisgr. C107 (m ²)	203510H Preisgr. C116 (m ²)					
sand white <input type="checkbox"/>			436110H Preisgr. C218 (m ²)		436116H Preisgr. C200 (m ²)	436122H Preisgr. C125 (m ²)	
italian white <input type="checkbox"/>				436156H Preisgr. C218 (m ²)			436162H Preisgr. C125 (m ²)
umber grey <input type="checkbox"/>			436111H Preisgr. C218 (m ²)		436117H Preisgr. C200 (m ²)	436123H Preisgr. C125 (m ²)	
belgish grey <input type="checkbox"/>				436157H Preisgr. C218 (m ²)			436163H Preisgr. C125 (m ²)
warm grey <input type="checkbox"/>			436112H Preisgr. C218 (m ²)		436118H Preisgr. C200 (m ²)	436124H Preisgr. C125 (m ²)	
urban grey <input type="checkbox"/>				436158H Preisgr. C218 (m ²)			436164H Preisgr. C125 (m ²)
red clay <input type="checkbox"/>			436113H Preisgr. C218 (m ²)		436119H Preisgr. C200 (m ²)	436125H Preisgr. C125 (m ²)	
persian red <input type="checkbox"/>				436159H Preisgr. C218 (m ²)			436165H Preisgr. C125 (m ²)
mud green <input type="checkbox"/>			436114H Preisgr. C218 (m ²)		436120H Preisgr. C200 (m ²)	436126H Preisgr. C125 (m ²)	
beach white <input type="checkbox"/>				436160H Preisgr. C218 (m ²)			436166H Preisgr. C125 (m ²)
light grey <input type="checkbox"/>			436115H Preisgr. C218 (m ²)		436121H Preisgr. C200 (m ²)	436127H Preisgr. C125 (m ²)	
nordic grey <input type="checkbox"/>				436161H Preisgr. C218 (m ²)			436167H Preisgr. C125 (m ²)



² nicht frostsicher

Bodenfliesen¹

60 x 60 cm

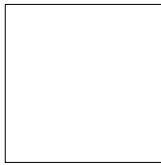

60 x 120 cm^{2/3}



120 x 120 cm^{2/3/4}

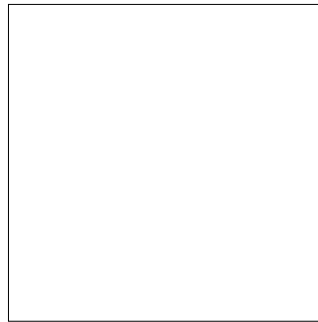

Mosaik⁵

5 x 15 cm



5 x 15 cm



Concrete			Travertine			Nennmaß - cm/in
60 x 60 / 24 x 24	60 x 120 / 24 x 48	120 x 120 / 48 x 48	30 x 30 / 12 x 12	30 x 30 / 12 x 12	Herstellmaß	
597 x 597 x 9 mm	597 x 1197 x 9 mm	1197 x 1197 x 9 mm	297 x 297 x 9 mm	297 x 297 x 9 mm	297 x 297 x 9 mm	
strukturiert, matt	eben, matt	strukturiert, matt	strukturiert, matt	eben, matt	eben, matt	Oberfläche
2,778	1,388	0,694	11,111	11,111	11,111	m ² - Stück
20,371	21,132	21,098	19,833	19,833	19,833	m ² - kg
3	2	2	12 Bögen	12 Bögen	12 Bögen	Paket - Stück
1,080 m ²	1,440 m ²	2,882 m ²	0,1080	0,1080	0,1080	Paket - m ²
21,999	30,450	60,800	21,420	21,420	21,420	Paket - kg
45,356	50,432	57,637	32,400	32,400	32,400	Palette - m ²
923,958	1.065,750	1.216,000	642,600	642,600	642,600	Palette - kg
Bla	Bla	Bla	Bla	Bla	Bla	Produktnorm
R10/A+B	R10/A+B	R10/A+B	R10/A+B	R10/A+B	R10/A+B	Trittsicherheit
2	2	2	2	2	2	Belastung
436128H		436134	436138H			sand white <input type="checkbox"/> V2
Preisgr. C140 (m ²)		Preisgr. C260 (m ²)	Preisgr. C348 (m ²)			italian white <input type="checkbox"/> V3
	436168H			436174H		umber grey <input type="checkbox"/> V2
	Preisgr. C152 (m ²)			Preisgr. C348 (m ²)		belgish grey <input type="checkbox"/> V3
436129H		436135	436139H			warm grey <input type="checkbox"/> V2
Preisgr. C140 (m ²)		Preisgr. C260 (m ²)	Preisgr. C348 (m ²)			urban grey <input type="checkbox"/> V3
	436169H			436175H		red clay <input type="checkbox"/> V2
	Preisgr. C152 (m ²)			Preisgr. C348 (m ²)		persian red <input type="checkbox"/> V3
436130H		436136	436140H			mud green <input type="checkbox"/> V2
Preisgr. C140 (m ²)		Preisgr. C260 (m ²)	Preisgr. C348 (m ²)			beach white <input type="checkbox"/> V3
	436170H			436176H		light grey <input type="checkbox"/> V2
	Preisgr. C152 (m ²)			Preisgr. C348 (m ²)		nordic grey <input type="checkbox"/> V3
436131H			436141H			
Preisgr. C140 (m ²)			Preisgr. C348 (m ²)			
	436171H			436177H		
	Preisgr. C152 (m ²)			Preisgr. C348 (m ²)		
436132H			436142H			
Preisgr. C140 (m ²)			Preisgr. C348 (m ²)			
	436172H			436178H		
	Preisgr. C152 (m ²)			Preisgr. C348 (m ²)		
436133H		436137	436143H			
Preisgr. C140 (m ²)		Preisgr. C260 (m ²)	Preisgr. C348 (m ²)			
	436173H			436179H		
	Preisgr. C152 (m ²)			Preisgr. C348 (m ²)		



¹ Hohes Gewicht! Karton bitte nur zu Zweit transportieren.

³ Achtung: Sonderpalette. Keine Rücknahme, kein Umtausch.

⁴ ohne Hytect-Veredelung; mit Protecta-Vergütung

⁵ Verklebung rückseitig auf Glasfasernetz



Treppen-
fliese^{1/2}

30 x 60 cm

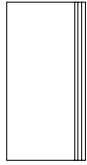
Treppen-
fliese mit
Schräge^{2/3/4}

31 x 145 cm

Setzstufe^{2/3/4} Sockel, gerundet¹

28 x 145 cm



7 x 60 cm



7 x 60 cm



	Concrete	Travertine	Travertine	Concrete	Travertine		
Nennmaß - cm/in	30 x 60 / 12 x 24	31 x 145 / 12 3/8 x 58	28 x 145 / 11 3/16 x 58	7 x 60 / 2 13/16 x 24	7 x 60 / 2 13/16 x 24		
Herstellmaß	297 x 597 x 9 mm	307 x 1447 x 10,5 mm	280 x 1447 x 10,5 mm	70 x 597 x 9 mm	70 x 597 x 9 mm		
Oberfläche	strukturiert, matt	eben, matt	eben, matt	strukturiert, matt	strukturiert, matt		
m - Stück	1,667	0,690	0,690	1,667	1,667		
m - kg	5,973	7,480	6,716	1,357	1,357		
Paket - Stück	7	2	2	15	15		
Paket - m	4,199	2,899	2,899	8,998	8,998		
Paket - kg	25,081	21,682	19,466	12,210	12,210		
Palette - m ²							
Palette - kg							
Produktnorm	Bla	Ala	Ala	Bla	Bla		
Trittsicherheit	R10/A+B	R10/A+B	R10/A+B				
Belastung	2	2	2				
sand white <input type="checkbox"/>	436144H Preisgr. C474 (St.)			436150H Preisgr. C440 (St.)			
italian white <input type="checkbox"/>		436180H Preisgr. C558 (St.)	436186H Preisgr. C525 (St.)		436192H Preisgr. C440 (St.)		
umber grey <input type="checkbox"/>	436145H Preisgr. C474 (St.)			436151H Preisgr. C440 (St.)			
belgish grey <input type="checkbox"/>		436181H Preisgr. C558 (St.)	436187H Preisgr. C525 (St.)		436193H Preisgr. C440 (St.)		
warm grey <input type="checkbox"/>	436146H Preisgr. C474 (St.)			436152H Preisgr. C440 (St.)			
urban grey <input type="checkbox"/>		436182H Preisgr. C558 (St.)	436188H Preisgr. C525 (St.)		436194H Preisgr. C440 (St.)		
red clay <input type="checkbox"/>	436147H Preisgr. C474 (St.)			436153H Preisgr. C440 (St.)			
persian red <input type="checkbox"/>		436183H Preisgr. C558 (St.)	436189H Preisgr. C525 (St.)		436195H Preisgr. C440 (St.)		
mud green <input type="checkbox"/>	436148H Preisgr. C474 (St.)			436154H Preisgr. C440 (St.)			
beach white <input type="checkbox"/>		436184H Preisgr. C558 (St.)	436190H Preisgr. C525 (St.)		436196H Preisgr. C440 (St.)		
light grey <input type="checkbox"/>	436149H Preisgr. C474 (St.)			436155H Preisgr. C440 (St.)			
nordic grey <input type="checkbox"/>		436185H Preisgr. C558 (St.)	436191H Preisgr. C525 (St.)		436197H Preisgr. C440 (St.)		

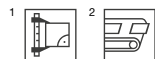

³ Nur an den zwei kurzen Seiten rektifiziert. Die Längsseite kann nicht rektifiziert werden.

⁴ Details siehe S. 538

Rendering / Architekt: Hadi Teherani







Natürlich ausdrucksstark

Solid Rock – schon dieser Name ist ein klares Statement. Und die robuste Qualität dieser Serie ist fast in Stein gemeißelt. Solid Rock hebt die Grenzen zwischen Innen und Außen auf. Rein ästhetisch, weil sie die Kraft der Natur in Bäder, Foyers und alle anderen Räume bringt. Grenzlose Möglichkeiten bieten sich aber auch bei der Verlegung. Weil Innenfliesen im Verbund mit Solid Rock Terrassenplatten nahtlose Übergänge zwischen Drinnen und Draußen realisieren. Ein Highlight für Hotels und Restaurants, aber auch im privaten Wohnbereich. Die lebendige Struktur der Fliesen akzentuiert Räume klar und stringent. Der Mauerverbund Move erweitert die gestalterischen Freiheiten für Architekten und Planer noch einmal. Das liegt an den verschiedenen und sorgfältig ausgewählten Farbtönen, in denen diese ästhetisch wirklich atemberaubende Fliese lieferbar ist. Solid Rock ist Protecta vergütet und damit unempfindlich gegen Schmutz und Flecken.

Rendering / Architekt: VSBL, Belgrad, Serbien



R10/A+B

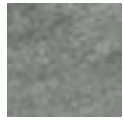

dark green



silver



mud grey



natural grey



deep grey



Wand-/Bodenfliese 5 x 60 cm, strukturiert, R10/A+B



Wand-/Bodenfliese 10 x 60 cm, strukturiert, R10/A+B



Wand-/Bodenfliese 15 x 60 cm, strukturiert, R10/A+B

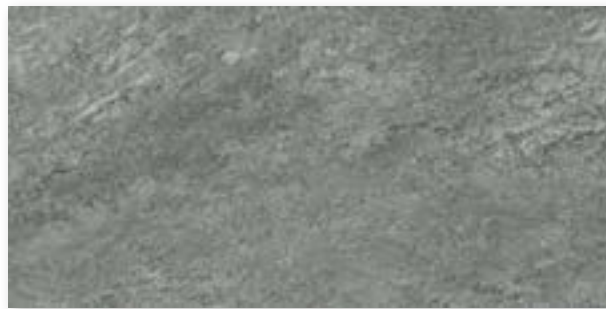

Wand-/Bodenfliese 30 x 60 cm, strukturiert, R10/A+B



Wand-/Bodenfliese 60 x 60 cm, strukturiert, R10/A+B



Wand-/Bodenfliese 60 x 120 cm, strukturiert, R10/A+B

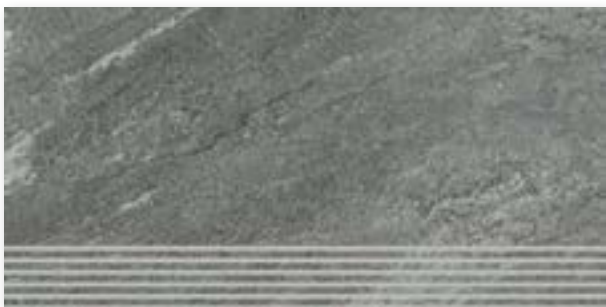

Treppenfliese 30 x 60 cm (rilliert), strukturiert, R10/A+B



Sockel, gerundet 7 x 60 cm, strukturiert

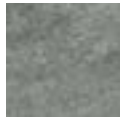

dark green



silver



mud grey



natural grey



deep grey

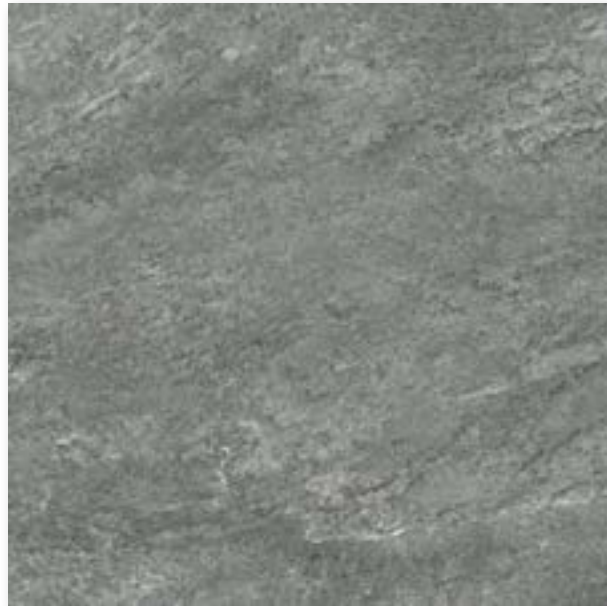

Terrassenplatte 60 x 60 cm, strukturiert, R11/B



Terrassenplatte 60 x 120 cm, strukturiert, R11/B



Mosaik 5 x 5 cm

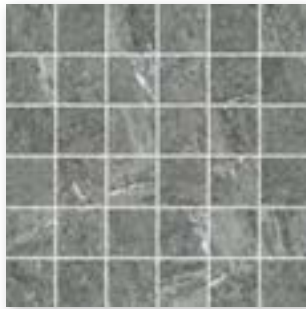

Mosaikbogen 30 x 30 cm
dark green, strukturiert, R10/A+B



Mosaikbogen 30 x 30 cm
silver, strukturiert, R10/A+B



Mosaikbogen 30 x 30 cm
mud grey, strukturiert, R10/A+B



Mosaikbogen 30 x 30 cm
natural grey, strukturiert, R10/A+B

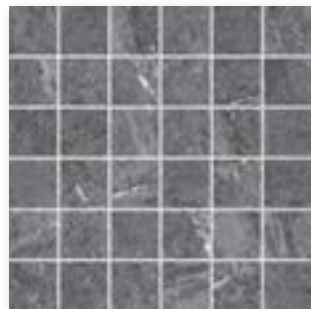

Mosaikbogen 30 x 30 cm
deep grey, strukturiert, R10/A+B

Verklebung rückseitig auf Glasfasernetz,
Bogen: 297 x 297 mm.

Dekorationselemente



Bordüre Move 15 x 60 cm, dark green, strukturiert, R10/A+B



Bordüre Move 15 x 60 cm, silver, strukturiert, R10/A+B



Bordüre Move 15 x 60 cm, mud grey, strukturiert, R10/A+B



Bordüre Move 15 x 60 cm, natural grey, strukturiert, R10/A+B



Bordüre Move 15 x 60 cm, deep grey, strukturiert, R10/A+B

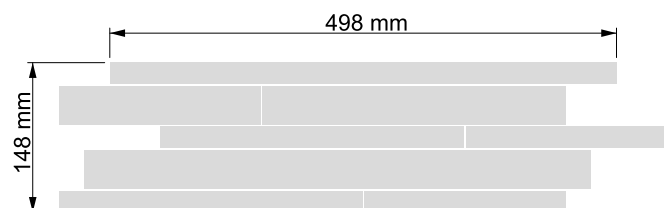

Verklebung rückseitig auf Glasfasernetz,
Bogen: 148 x 598 mm

Mosaik^{1/3} Wand- und Bodenfliesen¹

5 x 5 cm



5 x 60 cm²



10 x 60 cm²



15 x 60 cm²



30 x 60 cm



60 x 60 cm

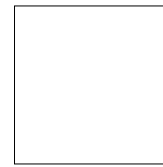



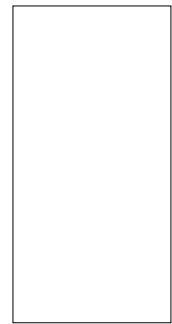

60 x 120 cm^{4/5}



protected

Bogen: 297 x 297 mm

Nennmaß - cm/in	5 x 5 / 2 x 2	5 x 60 / 2 x 24	10 x 60 / 4 x 24	15 x 60 / 6 x 24	30 x 60 / 12 x 24	60 x 60 / 24 x 24	60 x 120 / 24 x 48
Herstellmaß	47 x 47 x 9 mm	46 x 596 x 9 mm	96 x 596 x 9 mm	146 x 596 x 9 mm	297 x 596 x 9 mm	596 x 596 x 9 mm	596 x 1194 x 9 mm
Oberfläche	strukturiert, matt	strukturiert, matt	strukturiert, matt	strukturiert, matt	strukturiert, matt	strukturiert, matt	strukturiert, matt
m ² - Stück	11,111 Bögen	33,333	16,667	11,111	5,556	2,778	1,388
m ² - kg	19,833	19,899	20,283	19,899	19,841	19,288	21,514
Paket - Stück	12 Bögen	39	17	13	7	3	2
Paket - m ²	1,080 m ²	1,170	1,020	1,170	1,260	1,080	1,441
Paket - kg	21,420	23,283	20,689	23,283	24,997	20,829	31,000
Palette - m ²	32,400	46,800	40,799	46,800	50,396	43,197	50,432
Palette - kg	642,600	931,320	827,560	931,320	999,880	833,160	1.085,000
Produktnorm	Bla	Bla	Bla	Bla	Bla	Bla	Bla
Trittsicherheit	R10/A+B	R10/A+B	R10/A+B	R10/A+B	R10/A+B	R10/A+B	R10/A+B
Belastung	2	2	2	2	2	2	2
dark green 	431020 Preisgr. W303 (m ²)	<i>431021</i> Preisgr. <i>W210</i> (m ²)	<i>431022</i> Preisgr. <i>W210</i> (m ²)	<i>431023</i> Preisgr. <i>W186</i> (m ²)	431024 Preisgr. W102 (m ²)	431025 Preisgr. W117 (m ²)	431026 Preisgr. W156 (m ²)
silver 	430853 Preisgr. W303 (m ²)	<i>430857</i> Preisgr. <i>W210</i> (m ²)	<i>430861</i> Preisgr. <i>W210</i> (m ²)	<i>430865</i> Preisgr. <i>W186</i> (m ²)	430869 Preisgr. W102 (m ²)	430873 Preisgr. W117 (m ²)	430877 Preisgr. W156 (m ²)
mud grey 	430854 Preisgr. W303 (m ²)	<i>430858</i> Preisgr. <i>W210</i> (m ²)	<i>430862</i> Preisgr. <i>W210</i> (m ²)	<i>430866</i> Preisgr. <i>W186</i> (m ²)	430870 Preisgr. W102 (m ²)	430874 Preisgr. W117 (m ²)	430878 Preisgr. W156 (m ²)
natural grey 	430855 Preisgr. W303 (m ²)	<i>430859</i> Preisgr. <i>W210</i> (m ²)	<i>430863</i> Preisgr. <i>W210</i> (m ²)	<i>430867</i> Preisgr. <i>W186</i> (m ²)	430871 Preisgr. W102 (m ²)	430875 Preisgr. W117 (m ²)	430879 Preisgr. W156 (m ²)
deep grey 	430856 Preisgr. W303 (m ²)	<i>430860</i> Preisgr. <i>W210</i> (m ²)	<i>430864</i> Preisgr. <i>W210</i> (m ²)	<i>430868</i> Preisgr. <i>W186</i> (m ²)	430872 Preisgr. W102 (m ²)	430876 Preisgr. W117 (m ²)	430880 Preisgr. W156 (m ²)

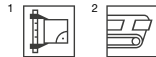

³ Verklebung rückseitig auf Glasfasernetz

⁴ Hohes Gewicht! Karton bitte nur zu Zweit transportieren.

⁵ Achtung: Sonderpalette. Keine Rücknahme, kein Umtausch.

**Dekorations-
elemente^{1/5/6}**

15 x 60 cm



**Treppen-
fliese^{1/2}**

30 x 60 cm

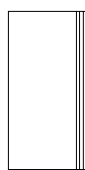

**Sockel,
gerundet¹**

7 x 60 cm



Terrassenplatten^{1/3}

60 x 60 cm

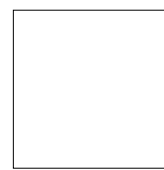

60 x 120 cm⁴

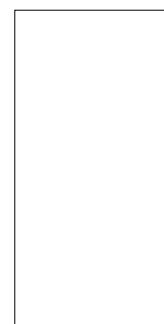

protected

Bordüre Move
Bogen: 148 x 598 mm

	15 x 60 / 6 x 24	30 x 60 / 12 x 24	7 x 60 / 2 13/16 x 24	60 x 60 / 24 x 24	60 x 120 / 24 x 48	Nennmaß - cm/in
	148 x 598 x 9 mm	297 x 596 x 9 mm	70 x 596 x 9 mm	596 x 596 x 20 mm	596 x 1194 x 20 mm	Herstellmaß
	strukturiert, matt	strukturiert, matt	strukturiert, matt	strukturiert, matt	strukturiert, matt	Oberfläche
	2,000/m	1,667/m	1,667/m	2,778/m ²	1,388/m ²	m ² /m - Stück
	2,780/m	5,973/m	1,357/m	47,226/m ²	45,110/m ²	m ² /m - kg
	2	7	22	2	1	Paket - Stück
	1,000 m	4,199 m	13,197 m	0,720 m ²	0,720 m ²	Paket - m ² /m
	2,780	25,081	17,908	34,000	32,500	Paket - kg
				21,598	25,216	Palette - m ²
				1.020,000	1.137,500	Palette - kg
	Bla	Bla	Bla	Bla	Bla	Produktnorm
	R10/A+B	R10/A+B		R11/B	R11/B	Trittsicherheit
	2	2		4	4	Belastung
	431029	431030	431031	431027	431028	
	Preisgr. W488 (St.)	Preisgr. W473 (St.)	Preisgr. W439 (St.)	Preisgr. W177 (m ²)	Preisgr. W216 (m ²)	dark green <input type="checkbox"/> V2
	430897	430893	430889	430881	430885	silver <input type="checkbox"/> V2
	Preisgr. W488 (St.)	Preisgr. W473 (St.)	Preisgr. W439 (St.)	Preisgr. W177 (m ²)	Preisgr. W216 (m ²)	
	430898	430894	430890	430882	430886	mud grey <input type="checkbox"/> V2
	Preisgr. W488 (St.)	Preisgr. W473 (St.)	Preisgr. W439 (St.)	Preisgr. W177 (m ²)	Preisgr. W216 (m ²)	
	430899	430895	430891	430883	430887	natural grey <input type="checkbox"/> V2
	Preisgr. W488 (St.)	Preisgr. W473 (St.)	Preisgr. W439 (St.)	Preisgr. W177 (m ²)	Preisgr. W216 (m ²)	
	430900	430896	430892	430884	430888	deep grey <input type="checkbox"/> V2
	Preisgr. W488 (St.)	Preisgr. W473 (St.)	Preisgr. W439 (St.)	Preisgr. W177 (m ²)	Preisgr. W216 (m ²)	



- ³ Hohes Gewicht! Karton bitte nur zu Zweit transportieren.
⁴ Achtung: Sonderpalette. Keine Rücknahme, kein Umtausch.
⁵ Verklebung rückseitig auf Glasfasernetz
⁶ Abgabe der Dekorationselemente ausschließlich in vollen Kartons.







Klassiker fürs Bad

Wenn schlicht weiß geflieste Wände bislang als das vielleicht zeitloseste Setting fürs Bad galten, dann kommt mit Stone Concept eine Variante hinzu, die das Zeug zum Klassiker hat: Organische Marmor- und Natursteinoptiken im bewährten Format 30 x 60 cm erzeugen ein wohnlich warmes Ambiente und verwandeln das Bad in eine Wohlfühl-Oase. Mit sechs verschiedenen Designs und Oberflächen von transparent glänzend bis steinmatt eröffnet die Serie flexible Gestaltungsmöglichkeiten und bleibt dabei in ihrer natürlichen Schlichtheit stets ein zeitloser Rahmen fürs private Refugium oder das Hotel-Bad.

Rendering

Dekorationselemente



Wandfliese 30 x 60 cm, Calacatta gold, eben, glänzend



Dekorfliese 30 x 60 cm, Calacatta gold, reliefiert, glänzend



Wandfliese 30 x 60 cm, Calacatta gold, eben, seidenmatt



Dekorfliese 30 x 60 cm, Calacatta gold, reliefiert, seidenmatt



Wandfliese 30 x 60 cm, Carrara bianco, eben, glänzend



Wandfliese 30 x 60 cm, Carrara bianco, eben, seidenmatt



Wandfliese 30 x 60 cm, Patagonia, eben, glänzend

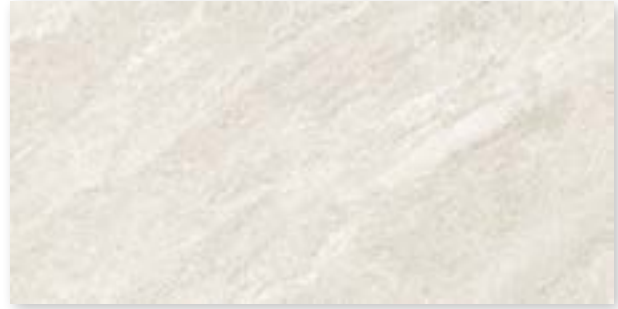

Wandfliese 30 x 60 cm, Vals Stone sandbeige, strukturiert, steinmatt



Wandfliese 30 x 60 cm, Patagonia, eben, steinmatt



Wandfliese 30 x 60 cm, Vals Stone anthrazit, strukturiert, steinmatt

Dekorationselemente



Wandfliese 30 x 60 cm, Silk Stone puderbeige, eben, seidenmatt



Dekorfliese 30 x 60 cm, Silk Stone puderbeige, reliefiert, seidenmatt

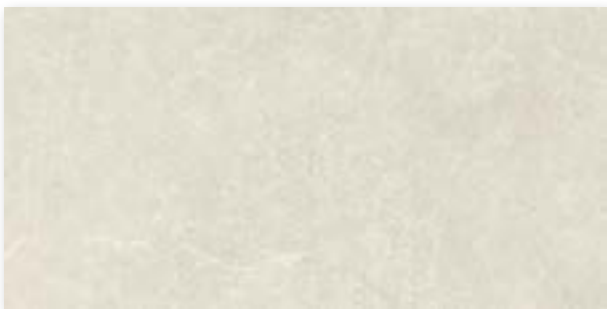

Wandfliese 30 x 60 cm, Silk Stone kieselgrau, eben, seidenmatt



Dekorfliese 30 x 60 cm, Silk Stone kieselgrau, reliefiert, seidenmatt

Dekorationselemente



Wandfliese 30 x 60 cm, Travertin cremebeige, eben, seidenmatt



Dekorfliese 30 x 60 cm, Travertin cremebeige, reliefiert, seidenmatt



Wandfliese 30 x 60 cm, Travertin graubeige, eben, seidenmatt



Dekorfliese 30 x 60 cm, Travertin graubeige, reliefiert, seidenmatt

Wandfliese Dekorations-
element Wandfliese Dekorations-
element Wandfliesen

30 x 60 cm

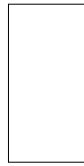

Dekorfliese

Dekorfliese

	30 x 60 / 12 x 24	30 x 60 / 12 x 24	30 x 60 / 12 x 24	30 x 60 / 12 x 24	30 x 60 / 12 x 24	30 x 60 / 12 x 24	Nennmaß - cm/in
	297 x 597 x 6 mm	297 x 597 x 6 mm	297 x 597 x 6 mm	297 x 597 x 6 mm	297 x 597 x 6 mm	297 x 597 x 6 mm	Herstellmaß
	eben, glänzend	reliefiert, glänzend	eben, seidenmatt	reliefiert, seidenmatt	eben, steinmatt	strukturiert, steinmatt	Oberfläche
	5,556	5,556	5,556	5,556	5,556	5,556	m ² - Stück
	10,279	10,279	10,279	10,279	10,279	10,279	m ² - kg
	13	11	13	11	13	13	Paket - Stück
	2,340	1,980	2,340	1,980	2,340	2,340	Paket - m ²
	24,050	21,241	24,050	21,241	24,050	24,050	Paket - kg
	112,311	95,032	112,311	95,032	112,311	112,311	Palette - m ²
	1.154,400	1.019,568	1.154,400	1.019,568	1.154,400	1.154,400	Palette - kg
	BIII	BIII	BIII	BIII	BIII	BIII	Produktnorm
	203511	203514	203515	203521			Calacatta gold <input type="checkbox"/> V3
	Preisgr. C56 (m ²)	Preisgr. C56 (m ²)	Preisgr. C56 (m ²)	Preisgr. C56 (m ²)			Carrara bianco <input type="checkbox"/> V2
	203512		203516				Patagonia <input type="checkbox"/> V4
	Preisgr. C56 (m ²)		Preisgr. C56 (m ²)		203526		Vals Stone
	203513				Preisgr. C56 (m ²)		sandbeige <input type="checkbox"/> V2
	Preisgr. C56 (m ²)					203527	Vals Stone
						Preisgr. C56 (m ²)	anthrazit <input type="checkbox"/> V2
			203517	203522			Silk Stone
			Preisgr. C56 (m ²)	Preisgr. C56 (m ²)			puderbeige <input type="checkbox"/> V2
			203518	203523			Silk Stone
			Preisgr. C56 (m ²)	Preisgr. C56 (m ²)			kieselgrau <input type="checkbox"/> V2
			203519	203524			Travertin
			Preisgr. C56 (m ²)	Preisgr. C56 (m ²)			cremebeige <input type="checkbox"/> V2
			203520	203525			Travertin
			Preisgr. C56 (m ²)	Preisgr. C56 (m ²)			graubeige <input type="checkbox"/> V3





Natürliche Eleganz

Das Design Stone verbindet weiche Maserungen, natürliche Aderungen und feine Schattierungen zu einer wohnlichen Optik. Die Farbpalette umfasst Farbtöne von Beige bis Anthrazit und unterstreicht die Ursprünglichkeit und Eleganz der Fliesen. Die Fliesen der Serie Stone Duo sind durchgängig mit der innovativen und reinigungsfreundlichen Hytect-Oberfläche ausgestattet. Diese Eigenschaft gewährleistet nicht nur eine einfache Pflege, sondern auch langanhaltende Schönheit und macht die Serie zur idealen Wahl für anspruchsvolle Bauherren.

Rendering



R10/A+B



hellgrau



schlamm



beige

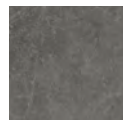

anthrazit



Bodenfliese, Design Stone, 30 x 60 cm, strukturiert, R10/A+B



Bodenfliese, Design Ceppo, 30 x 60 cm, strukturiert, R10/A+B



Bodenfliese, Design Stone, 60 x 60 cm, strukturiert, R10/A+B



Bodenfliese, Design Ceppo, 60 x 60 cm, strukturiert, R10/A+B



Bodenfliese, Design Stone, 60 x 120 cm, strukturiert, R10/A+B



Bodenfliese, Design Ceppo, 60 x 120 cm, strukturiert, R10/A+B



Treppenfliese, Design Stone, 30 x 60 cm (rilliert), strukturiert, R10/A+B



Treppenfliese, Design Ceppo, 30 x 60 cm (rilliert), strukturiert, R10/A+B



Sockel, gerundet, Design Stone, 7 x 60 cm, strukturiert



Sockel, gerundet, Design Ceppo, 7 x 60 cm, strukturiert

Mosaik 5 x 5

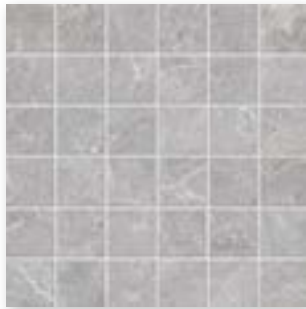

Mosaikbogen, Design Stone
30 x 30 cm, hellgrau,
strukturiert, R10/A+B

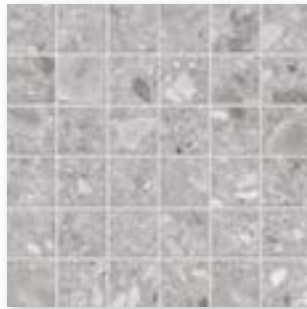

Mosaikbogen, Design Ceppo
30 x 30 cm, hellgrau,
strukturiert, R10/A+B

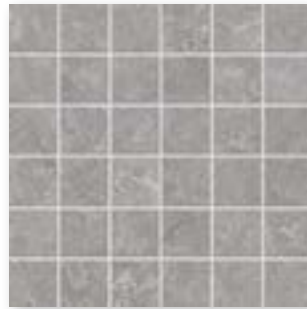

Mosaikbogen, Design Stone
30 x 30 cm, schlamm,
strukturiert, R10/A+B

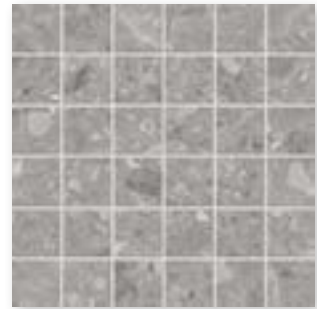

Mosaikbogen, Design Ceppo
30 x 30 cm, schlamm,
strukturiert, R10/A+B



Mosaikbogen, Design Stone
30 x 30 cm, beige,
strukturiert, R10/A+B



Mosaikbogen, Design Ceppo
30 x 30 cm, beige,
strukturiert, R10/A+B

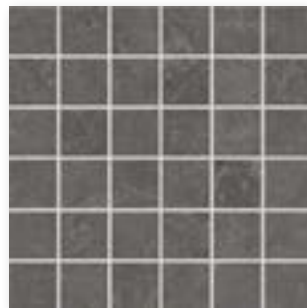

Mosaikbogen, Design Stone
30 x 30 cm, anthrazit,
strukturiert, R10/A+B

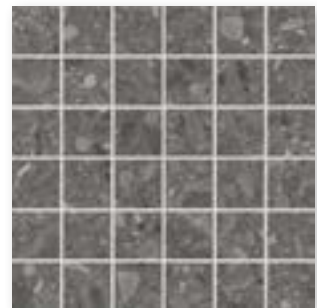

Mosaikbogen, Design Ceppo
30 x 30 cm, anthrazit,
strukturiert, R10/A+B

Dekorationselemente



Mosaikbogen, Design Twins
30 x 30 cm, hellgrau,
strukturiert, R10/A+B



Mosaikbogen, Design Twins
30 x 30 cm, schlamm,
strukturiert, R10/A+B

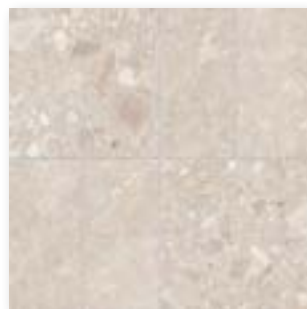

Mosaikbogen, Design Twins
30 x 30 cm, beige,
strukturiert, R10/A+B

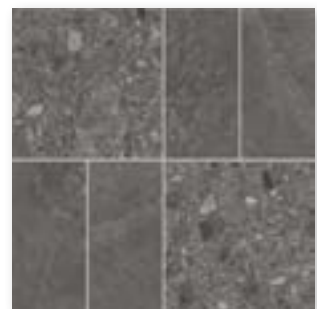

Mosaikbogen, Design Twins
30 x 30 cm, anthrazit,
strukturiert, R10/A+B

Verklebung rückseitig auf Glasfasernetz,
Bogen: 297 x 297 mm.

Mosaik^{1/2}

Bodenfliesen¹

5 x 5 cm



5 x 5 cm



30 x 60 cm

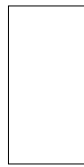

30 x 60 cm



60 x 60 cm

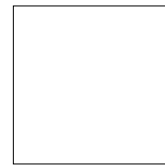

60 x 60 cm



	Stone Bogen: 297 x 297 mm	Ceppo Bogen: 297 x 297 mm	Stone	Ceppo	Stone	Ceppo	
	5 x 5 / 2 x 2	5 x 5 / 2 x 2	30 x 60 / 12 x 24	30 x 60 / 12 x 24	60 x 60 / 24 x 24	60 x 60 / 24 x 24	Nennmaß - cm/in
	47 x 47 x 9 mm	47 x 47 x 9 mm	297 x 597 x 9 mm	297 x 597 x 9 mm	597 x 597 x 9 mm	597 x 597 x 9 mm	Herstellmaß
	strukturiert, matt	strukturiert, matt	strukturiert, matt	strukturiert, matt	strukturiert, matt	strukturiert, matt	Oberfläche
	11,111 Bögen	11,111 Bögen	5,556	5,556	2,778	2,778	m ² - Stück
	19,833	19,833	19,907	19,907	20,371	20,371	m ² - kg
	12 Bögen	12 Bögen	7	7	3	3	Paket - Stück
	1,080	1,080	1,260	1,260	1,080	1,080	Paket - m ²
	21,420	21,420	25,081	25,081	21,999	21,999	Paket - kg
	32,400	32,400	50,396	50,396	45,356	45,356	Palette - m ²
	642,600	642,600	1.003,240	1.003,240	923,958	923,958	Palette - kg
	Bla	Bla	Bla	Bla	Bla	Bla	Produktnorm
	R10/A+B	R10/A+B	R10/A+B	R10/A+B	R10/A+B	R10/A+B	Trittsicherheit
	2	2	2	2	2	2	Belastung
	435948H Preisgr. C293 (m ²)		435956H Preisgr. C116 (m ²)		435964H Preisgr. C128 (m ²)		hellgrau <input type="checkbox"/> V2
		435952H Preisgr. C293 (m ²)		435960H Preisgr. C125 (m ²)		435968H Preisgr. C140 (m ²)	hellgrau <input type="checkbox"/> V3
	435949H Preisgr. C293 (m ²)		435957H Preisgr. C116 (m ²)		435965H Preisgr. C128 (m ²)		schlamm <input type="checkbox"/> V2
		435953H Preisgr. C293 (m ²)		435961H Preisgr. C125 (m ²)		435969H Preisgr. C140 (m ²)	schlamm <input type="checkbox"/> V3
	435950H Preisgr. C293 (m ²)		435958H Preisgr. C116 (m ²)		435966H Preisgr. C128 (m ²)		beige <input type="checkbox"/> V2
		435954H Preisgr. C293 (m ²)		435962H Preisgr. C125 (m ²)		435970H Preisgr. C140 (m ²)	beige <input type="checkbox"/> V3
	435951H Preisgr. C293 (m ²)		435959H Preisgr. C116 (m ²)		435967H Preisgr. C128 (m ²)		anthrazit <input type="checkbox"/> V2
		435955H Preisgr. C293 (m ²)		435963H Preisgr. C125 (m ²)		435971H Preisgr. C140 (m ²)	anthrazit <input type="checkbox"/> V3



² Verklebung rückseitig auf auf Glasfasernetz



Bodenfliesen¹

**Dekorations-
element¹**

Treppenfliesen^{1/2}

Sockel, gerundet¹

60 x 120 cm^{3/4}

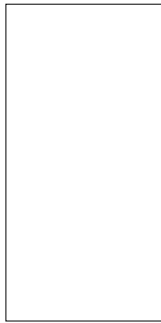

60 x 120 cm^{3/4}

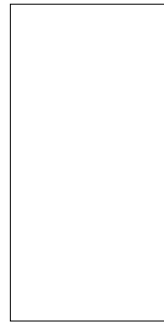

30 x 30 cm



30 x 60 cm



30 x 60 cm

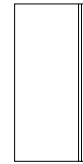

7 x 60 cm



7 x 60 cm



	Stone		Twins Bogen 297 x 297 mm	Stone		Ceppo	
Nennmaß - cm/in	60 x 120 / 24 x 48	60 x 120 / 24 x 48	30 x 30 / 12 x 12	30 x 60 / 12 x 24	30 x 60 / 12 x 24	7 x 60 / 2 13/16 x 24	7 x 60 / 2 13/16 x 24
Herstellmaß	597 x 1197 x 9 mm	597 x 1197 x 9 mm	297 x 297 x 9 mm	297 x 597 x 9 mm	297 x 597 x 9 mm	70 x 597 x 9 mm	70 x 597 x 9 mm
Oberfläche	strukturiert, matt	strukturiert, matt	strukturiert, matt	strukturiert, matt	strukturiert, matt	strukturiert, matt	strukturiert, matt
m ² /m - Stück	1,388/m ²	1,388/m ²	3,333/m	1,667/m	1,667/m	1,667/m	1,667/m
m ² /m - kg	21,132/m ²	21,132/m ²	5,942/m	5,973/m	5,973/m	1,357/m	1,357/m
Paket - Stück	2	2	4	7	7	15	15
Paket - m ² /m	1,440 m ²	1,440 m ²	1,200 m	4,199 m	4,199 m	8,998 m	8,998 m
Paket - kg	30,450	30,450	7,132	25,081	25,081	12,210	12,210
Palette - m ²	50,432	50,432					
Palette - kg	1.065,750	1.065,750					
Produktnorm	Bla	Bla	Bla	Bla	Bla	Bla	Bla
Trittsicherheit	R10/A+B	R10/A+B	R10/A+B	R10/A+B	R10/A+B		
Belastung	2	2	2	2	2		
	435972H		435980H	<i>435984H</i>		435992H	
hellgrau	Preisgr. C149 (m ²)		Preisgr. C517 (St.)	Preisgr. C474 (St.)		Preisgr. C440 (St.)	
		435976H			<i>435988H</i>		435996H
hellgrau		Preisgr. C152 (m ²)			Preisgr. C474 (St.)		Preisgr. C440 (St.)
	435973H		435981H	<i>435985H</i>		435993H	
schlamm	Preisgr. C149 (m ²)		Preisgr. C517 (St.)	Preisgr. C474 (St.)		Preisgr. C440 (St.)	
		435977H			<i>435989H</i>		435997H
schlamm		Preisgr. C152 (m ²)			Preisgr. C474 (St.)		Preisgr. C440 (St.)
	435974H		435982H	<i>435986H</i>		435994H	
beige	Preisgr. C149 (m ²)		Preisgr. C517 (St.)	Preisgr. C474 (St.)		Preisgr. C440 (St.)	
		435978H			<i>435990H</i>		435998H
beige		Preisgr. C152 (m ²)			Preisgr. C474 (St.)		Preisgr. C440 (St.)
	435975H		435983H	<i>435987H</i>		435995H	
anthrazit	Preisgr. C149 (m ²)		Preisgr. C517 (St.)	Preisgr. C474 (St.)		Preisgr. C440 (St.)	
		435979H			<i>435991H</i>		435999H
anthrazit		Preisgr. C152 (m ²)			Preisgr. C474 (St.)		Preisgr. C440 (St.)



³ Hohes Gewicht! Karton bitte nur zu Zweit transportieren.
⁴ Achtung: Sonderpalette. Keine Rücknahme, kein Umtausch

Rendering







Wenn Räume erzählen

Die Serie Stories kommt durch und durch urban daher: mit ihrer Optik von Zement, ihren zeitlosen Grautönen, ihren vielen kreativen Möglichkeiten und ihrer faszinierenden Großzügigkeit. Über die bewusste Kombination von Serienkomponenten spiegeln sich die individuellen Vorlieben der Bewohner wider: Der Raum erzählt Geschichten. Die Bodenfliesen überzeugen durch ihre weichen Nuancierungen und ihre unverfälschte, steinmattige Charakteristik von Zement. Für ein reizvoll urbanes Flair. Spannend wird die Serie Stories durch ihre zwei Dekore: das Schnittdekor Tangram und das Volldekor Ivy.

Rendering



Wandfliese 30 x 60 cm, pearl, strukturiert

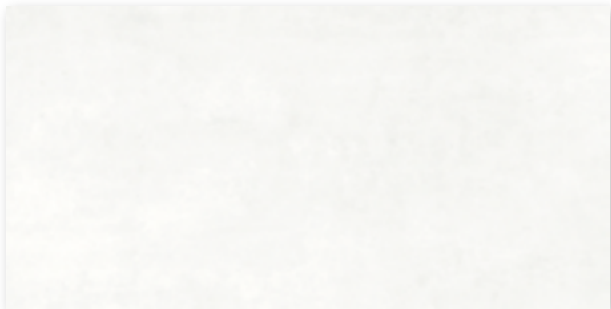

Wandfliese 30 x 60 cm, soft grey, strukturiert



Wandfliese 35 x 100 cm, pearl, strukturiert



Wandfliese 35 x 100 cm, soft grey, strukturiert

Dekorationselemente



Volldekor lvy 30 x 60 cm, soft sepia, strukturiert

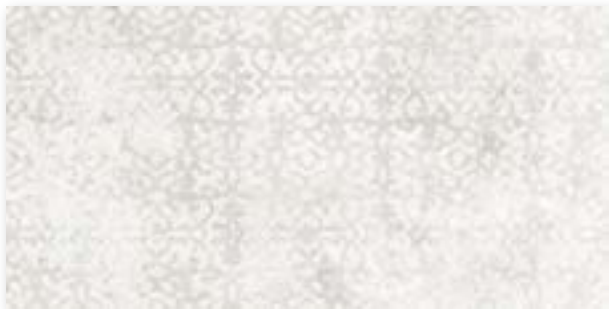

Volldekor lvy 30 x 60 cm, soft concrete, strukturiert



Volldekor lvy 35 x 100 cm, soft sepia, strukturiert



Volldekor lvy 35 x 100 cm, soft concrete, strukturiert

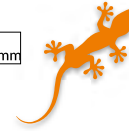

Dekorationselemente



Mosaikmatte Tangram 30 x 30 cm,
ivory, strukturiert, R10/A



Mosaikmatte Tangram 30 x 30 cm,
concrete, strukturiert, R10/A



Mosaikmatte Tangram 30 x 30 cm,
sepia, strukturiert, R10/A

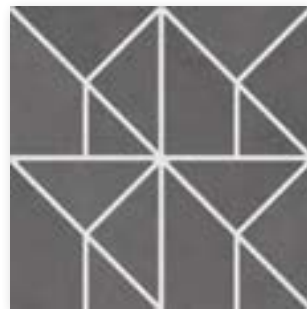

Mosaikmatte Tangram 30 x 30 cm,
anthracite, strukturiert, R10/A



R10/A



ivory

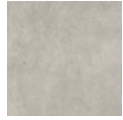

concrete

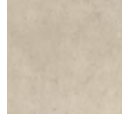

sepia



anthracite



Bodenfliese 30 x 60 cm, strukturiert, R10/A



Bodenfliese 60 x 60 cm, strukturiert, R10/A

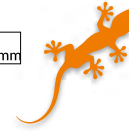

R10/A



ivory



concrete



sepia



anthracite

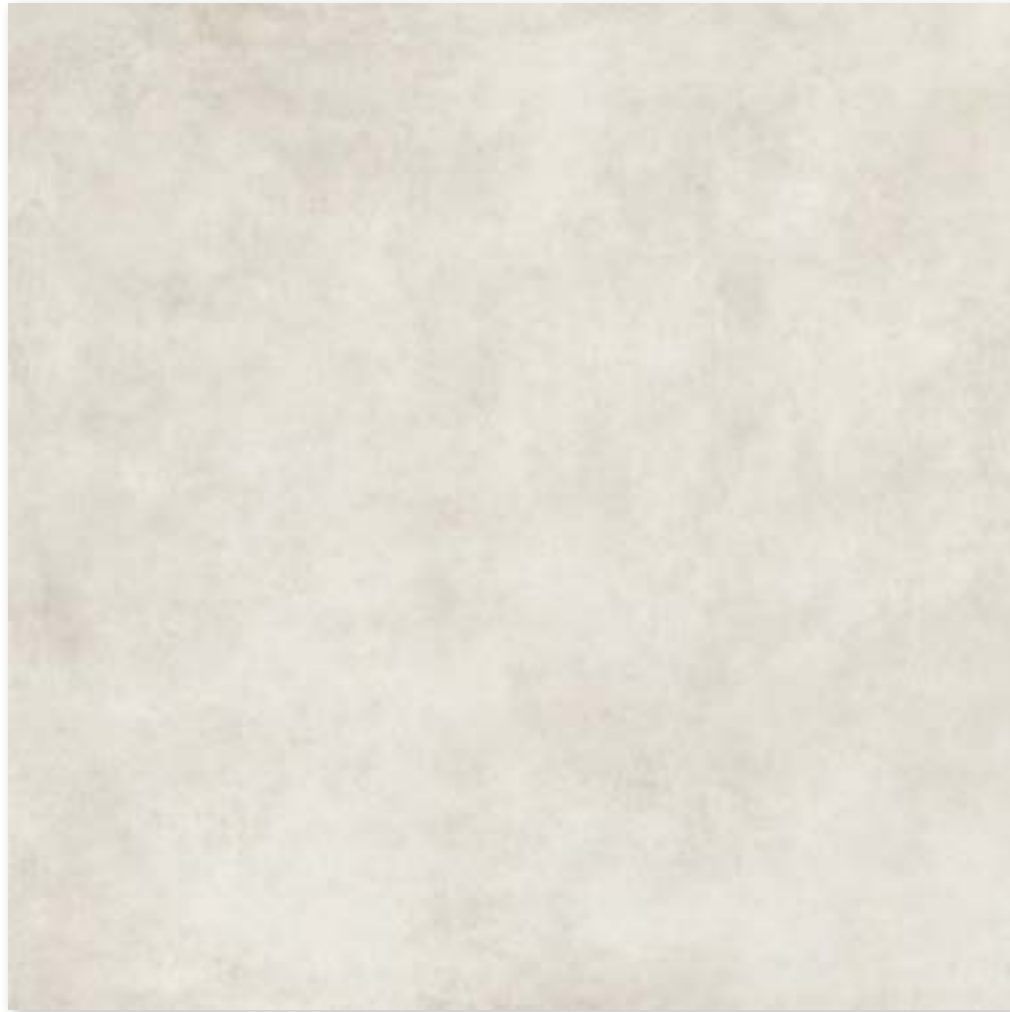

Bodenfliese 100 x 100 cm, strukturiert, R10/A



Treppenfliese 30 x 60 cm (rilliert), strukturiert, R10/A



Sockel, gerundet 7 x 60 cm, strukturiert



R10/B R11/B

Made in Germany

Mosaik 5 x 5 cm



Mosaikbogen 30 x 30 cm ivory, strukturiert, R10/B



Mosaikbogen 30 x 30 cm concrete, strukturiert, R10/B



Mosaikbogen 30 x 30 cm sepia, strukturiert, R10/B

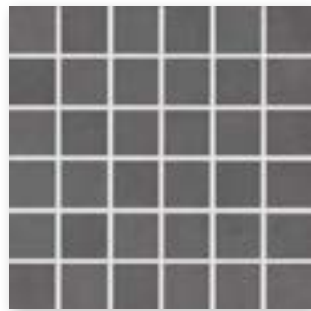

Mosaikbogen 30 x 30 cm anthracite, strukturiert, R10/B



Rückseitig thermoplastisch verklebte Mosaik von Agrob Buchtal sind nicht nur im Trockenbereich, sondern auch bedenkenlos im Unterwasserbereich (z. B. Schwimmbecken/ Whirlpool) sowie im dauer-nassbelasteten Bereich (z. B. Beckenumgänge/Duschen) einsetzbar.

Terrassenplatten



ivory



concrete



sepia



anthracite



Terrassenplatte 60 x 60 cm, strukturiert, R11/B

Wandfliesen

Dekorationselemente⁷

Mosaik^{3/4}

30 x 60 cm



35 x 100 cm²

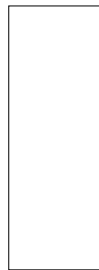

30 x 60 cm



35 x 100 cm²

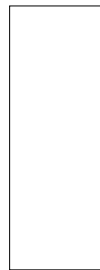

30 x 30 cm^{1/3/5/6}



5 x 5 cm



Nennmaß - cm/in	Volldekor Ivy		Volldekor Ivy		Mosaikmatte Tangram	
	30 x 60 / 12 x 24	35 x 100 / 14 x 40	30 x 60 / 12 x 24	35 x 100 / 14 x 40	Bogen: 297 x 297 mm	Bogen: 297 x 297 mm
Herstellmaß	297 x 597 x 6 mm	347 x 997 x 6 mm	297 x 597 x 6 mm	347 x 997 x 6 mm	297 x 297 x 6 mm	47 x 47 x 6,5 mm
Oberfläche	strukturiert, steinmatt	strukturiert, steinmatt	strukturiert, steinmatt	strukturiert, steinmatt	strukturiert, matt	strukturiert, matt
m ² /m - Stück	5,556/m ²	2,857/m ²	5,556/m ²	2,857/m ²	3,333 Bögen/m	11 Bögen/m ²
m ² /m - kg	10,279/m ²	10,108/m ²	10,279/m ²	10,108/m ²	3,776/m	12,331/m ²
Paket - Stück	13	5	13	5	3 Bögen	11 Bögen
Paket - m ² /m	2,340 m ²	1,750 m ²	2,340 m ²	1,750 m ²	0,900 m	1,000 m ²
Paket - kg	24,050	17,690	24,050	17,690	3,399	12,331
Palette - m ²	112,311	70,004	112,311	70,004		64,000
Palette - kg	1.154,400	707,600	1.154,400	707,600		789,184
Produktnorm	BIII	BIII	BIII	BIII	Bla	Bla
Trittsicherheit					R10/A	R10/B
Belastung					1	1
pearl <input type="checkbox"/>	203431H Preisgr. W90 (m ²)	363352H Preisgr. W132 (m ²)				
soft grey <input type="checkbox"/>	203433H Preisgr. W90 (m ²)	363353H Preisgr. W132 (m ²)				
soft sepia <input type="checkbox"/>			203432H Preisgr. W102 (m ²)	363354H Preisgr. W144 (m ²)		
soft concrete <input type="checkbox"/>			203434H Preisgr. W102 (m ²)	363355H Preisgr. W144 (m ²)		
ivory <input type="checkbox"/>					363356 Preisgr. W501 (St.)	432335H Preisgr. W177 (m ²)
concrete <input type="checkbox"/>					363357 Preisgr. W501 (St.)	432336H Preisgr. W177 (m ²)
sepia <input type="checkbox"/>					363358 Preisgr. W501 (St.)	432337H Preisgr. W177 (m ²)
anthracite <input type="checkbox"/>					363359 Preisgr. W501 (St.)	432338H Preisgr. W177 (m ²)

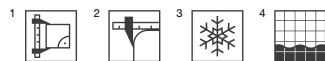

⁵ ohne Hytect-Veredelung; mit Protecta-Vergütung
⁶ Verklebung rückseitig auf Glasfasernetz
⁷ Abgabe der Dekorationselemente ausschließlich in vollen Kartons.

Bodenfliesen¹

30 x 60 cm



60 x 60 cm

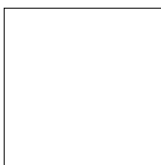

100 x 100 cm^{3/4/5/6}

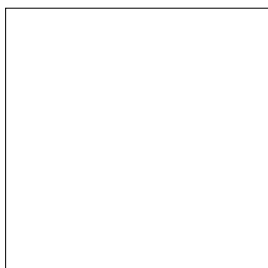

Treppen- fliese^{1/2}

30 x 60 cm

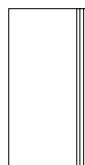

Sockel, gerundet¹

7 x 60 cm



Terrassen- platte^{1/5}

60 x 60 cm

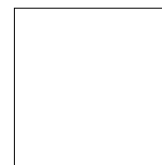

30 x 60 / 12 x 24	60 x 60 / 24 x 24	100 x 100 / 40 x 40		30 x 60 / 12 x 24	7 x 60 / 2 13/16 x 24	60 x 60 / 24 x 24	Nennmaß - cm/in
297 x 597 x 9 mm	597 x 597 x 9 mm	997 x 997 x 6 mm		297 x 597 x 9 mm	70 x 597 x 9 mm	597 x 597 x 20 mm	Herstellmaß
strukturiert, matt	strukturiert, matt	strukturiert, matt		strukturiert, matt	strukturiert, matt	strukturiert, matt	Oberfläche
5,556/m ²	2,778/m ²	1,000/m ²		1,667/m	1,667/m	2,778/m ²	m ² /m - Stück
19,907/m ²	20,371/m ²	14,100/m ²		5,973/m	1,357/m	45,273/m ²	m ² /m - kg
7	3	2		7	15	2	Paket - Stück
1,260 m ²	1,080 m ²	2,000 m ²		4,199 m	8,998 m	0,720 m ²	Paket - m ² /m
25,081	21,999	28,200		25,081	12,210	32,594	Paket - kg
50,396	45,356	50,000				21,598	Palette - m ²
1.003,240	923,958	705,000				977,820	Palette - kg
Bla	Bla	Bla		Bla	Bla	Bla	Produktnorm
R10/A	R10/A	R10/A		R10/A	R10/A	R11/B	Trittsicherheit
2	2	1		2		4	Belastung
431630H	431634H	432323		<i>431638H</i>	431642H	434986H	
Preisgr. W111 (m ²)	Preisgr. W123 (m ²)	Preisgr. W156 (m ²)		Preisgr. <i>W473</i> (St.)	Preisgr. W439 (St.)	Preisgr. W198 (m ²)	ivory <input type="checkbox"/> V2
431632H	431636H	432324		<i>431640H</i>	431644H	434987H	
Preisgr. W111 (m ²)	Preisgr. W123 (m ²)	Preisgr. W156 (m ²)		Preisgr. <i>W473</i> (St.)	Preisgr. W439 (St.)	Preisgr. W198 (m ²)	concrete <input type="checkbox"/> V2
431631H	431635H	432325		<i>431639H</i>	431643H	434988H	
Preisgr. W111 (m ²)	Preisgr. W123 (m ²)	Preisgr. W156 (m ²)		Preisgr. <i>W473</i> (St.)	Preisgr. W439 (St.)	Preisgr. W198 (m ²)	sepia <input type="checkbox"/> V2
431633H	431637H	432326		<i>431641H</i>	431645H	434989H	
Preisgr. W111 (m ²)	Preisgr. W123 (m ²)	Preisgr. W156 (m ²)		Preisgr. <i>W473</i> (St.)	Preisgr. W439 (St.)	Preisgr. W198 (m ²)	anthracite <input type="checkbox"/> V2



¹ ohne Hytect-Veredelung; mit Protecta-Vergütung

² Achtung: Sonderpalette. Keine Rücknahme, kein Umtausch.

³ Hohes Gewicht! Karton bitte nur zu Zweit transportieren.

⁴ Geeignet für den Einsatz in Bereichen mit Belastungsgruppe 1.







Neue Natürlichkeit

Strata interpretiert Naturfarbigkeit neu. Die neue Keramikserie von Agrob Buchtal wurde gemeinsam mit dem Farbdesigner Peter Zoernack entwickelt. Nach dem Vorbild der Natur wurden Farbtöne gesucht, die einem keramischen, steinernen Material entsprechen: Entstanden sind zwei Farbfamilien mit acht harmonischen Farben. Mit der nuancierten Farbpalette, der keramischen Umsetzung und ihrer Formatvielfalt bietet Strata Architekten und Planern einen nützlichen Baukasten für zeitlose Raumentwürfe. Technisch durchdacht bedient sie vielfältige praktische Anforderungen in Innen- und Außenbereichen.

Rendering / Architekten: VSBL, Belgrad, Serbien



R10/A+B



quarz



Riegelformat 10 x 60 cm, eben, R10/A+B



stein

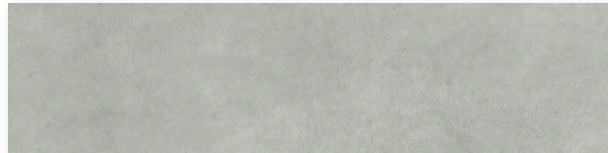

Riegelformat 15 x 60 cm, eben, R10/A+B

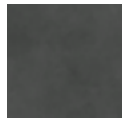

lava

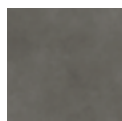

vulkan



Bodenfliese 30 x 60 cm, eben, R10/A+B
Bodenfliese 30 x 60 cm, eben, R11/B



Bodenfliese 30 x 30 cm, eben, R10/A+B

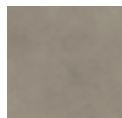

lehm

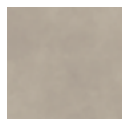

ton



Bodenfliese 60 x 60 cm, eben, R10/A+B

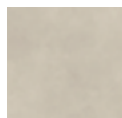

kalk

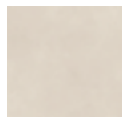

bims



Bodenfliese 60 x 120 cm, eben, R10/A+B



Treppenfiesen mit Rillierung 30 x 60 cm, eben, R10/A+B



Treppenfiesen mit Rillierung 60 x 120 cm, eben, R10/A+B



quarz



Sockel, gerundet 7 x 60 cm, eben



stein



lava



Treppenkante 4 x 60 cm, eben, R10/A+B



vulkan

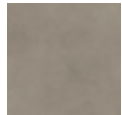

lehm



Treppenkante 7,2 x 60 cm, eben, R10/A+B



ton

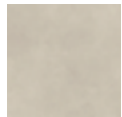

kalk



Treppenkante 7,2 x 120 cm, eben, R10/A+B

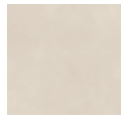

bims



Treppenkante mit Schräge 7,2 x 145 cm, eben, R10/A+B



Treppenfliesen mit Schräge 31 x 145 cm, eben, R10/A+B



Treppenfliesen mit Schräge und Rillierung 31 x 145 cm, eben, R10/A+B



Setzstufe 28 x 145 cm, eben, R10/A+B



Hohlkehlssockel 10 x 30 cm, eben



Hohlkehlssockel 10 x 60 cm, eben

Mosaik 5 x 5 cm

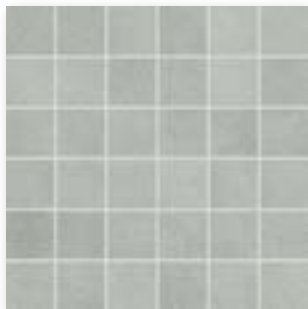

Mosaikbogen 30 x 30 cm
quarz, eben, R10/A+B

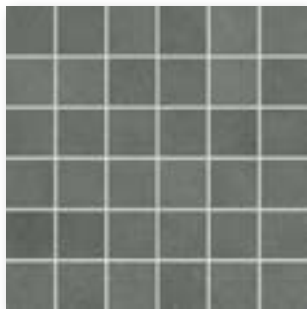

Mosaikbogen 30 x 30 cm
stein, eben, R10/A+B

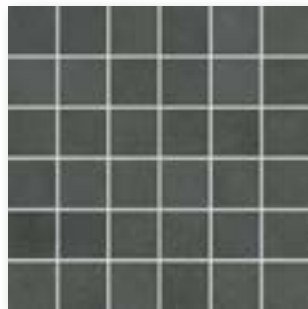

Mosaikbogen 30 x 30 cm
lava, eben, R10/A+B

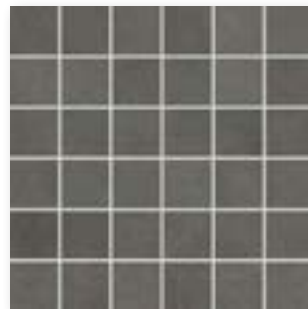

Mosaikbogen 30 x 30 cm
vulkan, eben, R10/A+B



Mosaikbogen 30 x 30 cm
lehm, eben, R10/A+B



Mosaikbogen 30 x 30 cm
ton, eben, R10/A+B



Mosaikbogen 30 x 30 cm
kalk, eben, R10/A+B



Mosaikbogen 30 x 30 cm
bims, eben, R10/A+B

Mosaikmatte Edge 30 x 30 cm



Mosaikbogen 30 x 30 cm
quarz, eben, R10/A+B

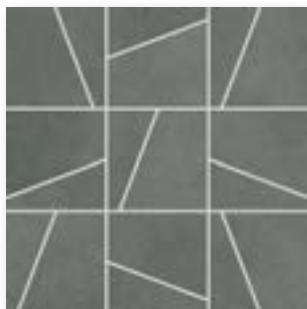

Mosaikbogen 30 x 30 cm
stein, eben, R10/A+B

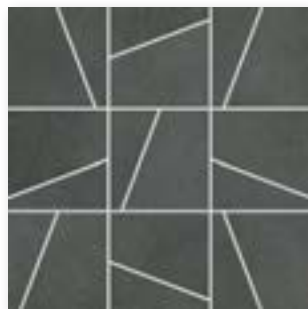

Mosaikbogen 30 x 30 cm
lava, eben, R10/A+B

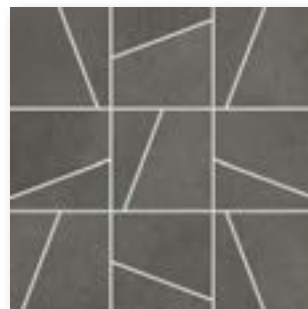

Mosaikbogen 30 x 30 cm
vulkan, eben, R10/A+B



Mosaikbogen 30 x 30 cm
lehm, eben, R10/A+B



Mosaikbogen 30 x 30 cm
ton, eben, R10/A+B



Mosaikbogen 30 x 30 cm
kalk, eben, R10/A+B



Mosaikbogen 30 x 30 cm
bims, eben, R10/A+B

Mosaik: Verklebung rückseitig auf Glasfasernetz,
Bogen: 297 x 297 mm.

Mosaik^{1/3}

Bodenfliesen¹

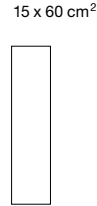
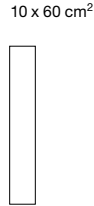
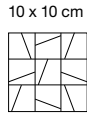
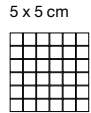

Mosaikmatte Edge Bogen: 297 x 297 mm		Riegelformat		Riegelformat		Riegelformat		Nennmaß - cm/in
5 x 5 / 2 x 2	10 x 10 / 4 x 4	10 x 60 / 4 x 24	15 x 60 / 6 x 24	30 x 30 / 12 x 12	30 x 60 / 12 x 24	30 x 60 / 12 x 24		
47 x 47 x 8 mm	97 x 97 x 8 mm	97 x 597 x 8 mm	147 x 597 x 8 mm	297 x 297 x 8 mm	297 x 597 x 8 mm	297 x 597 x 8 mm	297 x 597 x 8 mm	Herstellmaß
eben, matt	eben, matt	eben, matt	eben, matt	eben, matt	eben, matt	eben, matt	eben, matt	Oberfläche
11,111 Bögen/m ²	3,333 Bögen/m	16,667/m ²	11,111/m ²	11,111/m ²	5,556/m ²	5,556/m ²	5,556/m ²	m ² - Stück
16,389/m ²	4,823/m	17,417/m ²	17,411/m ²	17,222/m ²	17,696/m ²	17,696/m ²	17,696/m ²	m ² - kg
14 Bögen	3 Bögen	18	14	14	7	7	7	Paket - Stück
1,260 m ²	0,900 m	1,080 m ²	1,260 m ²	1,260 m ²	1,260 m ²	1,260 m ²	1,260 m ²	Paket - m ²
20,650	4,341	18,810	21,938	21,708	22,295	22,295	22,295	Paket - kg
37,800		43,199	50,401	60,481	50,396	50,396	50,396	Paket - m ²
619,500			877,520	1.041,600	891,800	891,800	891,800	Palette - kg
Bla	Bla	Bla	Bla	Bla	Bla	Bla	Bla	Produktnorm
R10/A+B	R10/A+B	R10/A+B	R10/A+B	R10/A+B	R10/A+B	R10/A+B	R11/B	Trittsicherheit
2	2	2	2	2	2	2	2	Belastung
435380H	435372H	<i>435397H</i>	<i>435409H</i>	435417H	435428H	435301H		quarz <input type="checkbox"/> V2
Preisgr. A265 (m ²)	Preisgr. A506 (St.)	Preisgr. A199 (m ²)	Preisgr. A199 (m ²)	Preisgr. A61 (m ²)	Preisgr. A115 (m ²)	Preisgr. A115 (m ²)		
435381H	435373H	<i>435398H</i>	<i>435410H</i>	435418H	435429H	435302H		stein <input type="checkbox"/> V2
Preisgr. A265 (m ²)	Preisgr. A506 (St.)	Preisgr. A199 (m ²)	Preisgr. A199 (m ²)	Preisgr. A61 (m ²)	Preisgr. A115 (m ²)	Preisgr. A115 (m ²)		
435382H	435374H	<i>435399H</i>	<i>435411H</i>	435419H	435430H	435303H		lava <input type="checkbox"/> V2
Preisgr. A265 (m ²)	Preisgr. A506 (St.)	Preisgr. A199 (m ²)	Preisgr. A199 (m ²)	Preisgr. A61 (m ²)	Preisgr. A115 (m ²)	Preisgr. A115 (m ²)		
435383H	435375H	<i>435400H</i>	<i>435412H</i>	435420H	435431H	435304H		vulkan <input type="checkbox"/> V2
Preisgr. A265 (m ²)	Preisgr. A506 (St.)	Preisgr. A199 (m ²)	Preisgr. A199 (m ²)	Preisgr. A61 (m ²)	Preisgr. A115 (m ²)	Preisgr. A115 (m ²)		
435384H	435376H	<i>435401H</i>	<i>435413H</i>	435421H	435432H	435305H		lehm <input type="checkbox"/> V2
Preisgr. A265 (m ²)	Preisgr. A506 (St.)	Preisgr. A199 (m ²)	Preisgr. A199 (m ²)	Preisgr. A61 (m ²)	Preisgr. A115 (m ²)	Preisgr. A115 (m ²)		
435385H	435377H	<i>435402H</i>	<i>435414H</i>	435422H	435433H	435306H		ton <input type="checkbox"/> V2
Preisgr. A265 (m ²)	Preisgr. A506 (St.)	Preisgr. A199 (m ²)	Preisgr. A199 (m ²)	Preisgr. A61 (m ²)	Preisgr. A115 (m ²)	Preisgr. A115 (m ²)		
435386H	435378H	<i>435403H</i>	<i>435415H</i>	435423H	435434H	435307H		kalk <input type="checkbox"/> V2
Preisgr. A265 (m ²)	Preisgr. A506 (St.)	Preisgr. A199 (m ²)	Preisgr. A199 (m ²)	Preisgr. A61 (m ²)	Preisgr. A115 (m ²)	Preisgr. A115 (m ²)		
435387H	435379H	<i>435404H</i>	<i>435416H</i>	435424H	435435H	435308H		bims <input type="checkbox"/> V2
Preisgr. A265 (m ²)	Preisgr. A506 (St.)	Preisgr. A199 (m ²)	Preisgr. A199 (m ²)	Preisgr. A61 (m ²)	Preisgr. A115 (m ²)	Preisgr. A115 (m ²)		

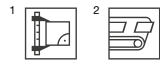

³ Verklebung rückseitig auf Glasfasernetz

Bodenfliesen¹

Treppenfliesen mit Rillierung^{1/2}

Treppenfliese mit Schräge^{2/4/5}

Treppenfliese mit Schräge & Rillierung^{2/4/5}

Setzstufe^{2/4}

60 x 60 cm

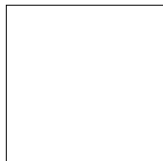

60 x 120 cm³



30 x 60 cm

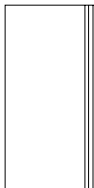

60 x 120 cm³

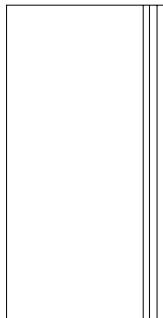

31 x 145 cm



31 x 145 cm

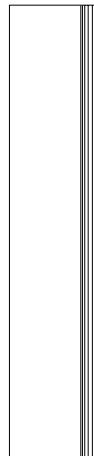

28 x 145 cm



Nennmaß - cm/in	60 x 60 / 24 x 24	60 x 120 / 24 x 48	30 x 60 / 12 x 24	60 x 120 / 24 x 48	31 x 145 / 12 3/8 x 58	31 x 145 / 12 3/8 x 58	28 x 145 / 11 3/16 x 58
Herstellmaß	597 x 597 x 8 mm	597 x 1197 x 8 mm	297 x 597 x 8 mm	597 x 1197 x 8 mm	307 x 1447 x 10,5 mm	307 x 1447 x 10,5 mm	280 x 1447 x 10,5 mm
Oberfläche	eben, matt	eben, matt	eben, matt	eben, matt	eben, matt	eben, matt	eben, matt
m ² /m - Stück	2,778/m ²	1,388/m ²	1,667/m	0,833/m	0,690/m	0,690/m	0,690/m
m ² /m - kg	18,107/m ²	18,784/m ²	5,310/m	11,273/m	7,480/m	7,480/m	6,716/m
Paket - Stück	4	2	7	2	2	2	2
Paket - m ² /m	1,440 m ²	1,440 m ²	4,200 m	2,401 m	2,899 m	2,899 m	2,899 m
Paket - kg	26,072	27,066	22,295	27,066	21,682	21,682	19,466
Palette - m ²	51,836	50,432					
Palette - kg	938,592	947,310					
Produktnorm	Bla	Bla	Bla	Bla	Ala	Ala	Ala
Trittsicherheit	R10/A+B	R10/A+B	R10/A+B	R10/A+B	R10/A+B	R10/A+B	R10/A+B
Belastung	2	2	2	2	2	2	2
quarz	435436H Preisgr. A127 (m ²)	435452H Preisgr. A124 (m ²)	435460H Preisgr. A465 (St.)	435452H-TF Preisgr. A593 (St.)	435468H Preisgr. A560 (St.)	435468H-TF Preisgr. A577 (St.)	435476H Preisgr. A528 (St.)
stein	435437H Preisgr. A127 (m ²)	435453H Preisgr. A124 (m ²)	435461H Preisgr. A465 (St.)	435453H-TF Preisgr. A593 (St.)	435469H Preisgr. A560 (St.)	435469H-TF Preisgr. A577 (St.)	435477H Preisgr. A528 (St.)
lava	435438H Preisgr. A127 (m ²)	435454H Preisgr. A124 (m ²)	435462H Preisgr. A465 (St.)	435454H-TF Preisgr. A593 (St.)	435470H Preisgr. A560 (St.)	435470H-TF Preisgr. A577 (St.)	435478H Preisgr. A528 (St.)
vulkan	435439H Preisgr. A127 (m ²)	435455H Preisgr. A124 (m ²)	435463H Preisgr. A465 (St.)	435455H-TF Preisgr. A593 (St.)	435471H Preisgr. A560 (St.)	435471H-TF Preisgr. A577 (St.)	435479H Preisgr. A528 (St.)
lehm	435440H Preisgr. A127 (m ²)	435456H Preisgr. A124 (m ²)	435464H Preisgr. A465 (St.)	435456H-TF Preisgr. A593 (St.)	435472H Preisgr. A560 (St.)	435472H-TF Preisgr. A577 (St.)	435480H Preisgr. A528 (St.)
ton	435441H Preisgr. A127 (m ²)	435457H Preisgr. A124 (m ²)	435465H Preisgr. A465 (St.)	435457H-TF Preisgr. A593 (St.)	435473H Preisgr. A560 (St.)	435473H-TF Preisgr. A577 (St.)	435481H Preisgr. A528 (St.)
kalk	435442H Preisgr. A127 (m ²)	435458H Preisgr. A124 (m ²)	435466H Preisgr. A465 (St.)	435458H-TF Preisgr. A593 (St.)	435474H Preisgr. A560 (St.)	435474H-TF Preisgr. A577 (St.)	435482H Preisgr. A528 (St.)
bims	435443H Preisgr. A127 (m ²)	435459H Preisgr. A124 (m ²)	435467H Preisgr. A465 (St.)	435459H-TF Preisgr. A593 (St.)	435475H Preisgr. A560 (St.)	435475H-TF Preisgr. A577 (St.)	435483H Preisgr. A528 (St.)

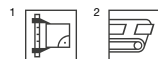

³ Hohes Gewicht! Karton bitte nur zu Zweit transportieren.
⁴ Nur an den zwei kurzen Seiten rektifiziert. Längsseite kann nicht rektifiziert werden.
⁵ Details siehe S. 538

Treppenkanten^{1/2}

Treppenkante mit Schräge^{2/3/4}

4 x 60 cm



7,2 x 60 cm



7,2 x 120 cm



7,2 x 145 cm



			4 x 60 / 1 5/8 x 24	7,2 x 60 / 2 7/8 x 24	7,2 x 120 / 2 7/8 x 48	7,2 x 145 / 2 7/8 x 58	Nennmaß - cm/in
			40 x 597 x 8 mm	72 x 597 x 8 mm	72 x 1197 x 8 mm	72 x 1447 x 10,5 mm	Herstellmaß
			eben, matt	eben, matt	eben, matt	eben, matt	Oberfläche
			1,667	1,667	0,833	0,690	m - Stück
			0,697	1,254	1,353	1,737	m - kg
			9	18	10	10	Paket - Stück
			5,399	10,7893	12,005	14,493	Paket - m
			3,762	13,536	16,240	25,180	Paket - kg
			Bla	Bla	Bla	Ala	Produktnorm
			R10/A+B	R10/A+B	R10/A+B	R10/A+B	Trittsicherheit
			2	2	2	2	Belastung
			435484H	435428H-TK	435452H-TK	435468H-TK	quarz <input type="checkbox"/> V2
			Preisgr. A458 (St.)	Preisgr. A458 (St.)	Preisgr. A511 (St.)	Preisgr. A539 (St.)	stein <input type="checkbox"/> V2
			435485H	435429H-TK	435453H-TK	435469H-TK	lava <input type="checkbox"/> V2
			Preisgr. A458 (St.)	Preisgr. A458 (St.)	Preisgr. A511 (St.)	Preisgr. A539 (St.)	vulkan <input type="checkbox"/> V2
			435486H	435430H	435454H-TK	435470H-TK	lehm <input type="checkbox"/> V2
			Preisgr. A458 (St.)	Preisgr. A458 (St.)	Preisgr. A511 (St.)	Preisgr. A539 (St.)	ton <input type="checkbox"/> V2
			435487H	435431H-TK	435455H-TK	435471H-TK	kalk <input type="checkbox"/> V2
			Preisgr. A458 (St.)	Preisgr. A458 (St.)	Preisgr. A511 (St.)	Preisgr. A539 (St.)	bims <input type="checkbox"/> V2
			435488H	435432H-TK	435456H-TK	435472H-TK	
			Preisgr. A458 (St.)	Preisgr. A458 (St.)	Preisgr. A511 (St.)	Preisgr. A539 (St.)	
			435489H	435433H-TK	435457H-TK	435473H-TK	
			Preisgr. A458 (St.)	Preisgr. A458 (St.)	Preisgr. A511 (St.)	Preisgr. A539 (St.)	
			435490H	435434H-TK	435458H-TK	435474H-TK	
			Preisgr. A458 (St.)	Preisgr. A458 (St.)	Preisgr. A511 (St.)	Preisgr. A539 (St.)	
			435491H	435435H-TK	435459H-TK	435475H-TK	
			Preisgr. A458 (St.)	Preisgr. A458 (St.)	Preisgr. A511 (St.)	Preisgr. A539 (St.)	



³ Nur an den zwei kurzen Seiten rektifiziert. Längsseite kann nicht rektifiziert werden.

⁴ Details siehe S. 538



Sockel, gerundet¹

Hohlkehlsoclel²

7 x 60 cm



10 x 30 cm



10 x 60 cm



Nennmaß - cm/in	7 x 60 / 2 13/16 x 24	10 x 30 / 4 x 12	10 x 60 / 4 x 24				
Herstellmaß	70 x 597 x 8 mm	102 x 297 x 9 mm	102 x 597 x 9 mm				
Oberfläche	eben, matt	eben, matt	eben, matt				
m - Stück	1,667	3,333	1,667				
m - kg	1,207	1,776	2,000				
Paket - Stück	15	16	16				
Paket - m	8,998	4,800	9,598				
Paket - kg	10,860	8,528	17,072				
Palette - m							
Palette - kg							
Produktnorm	Bla	Bla	Bla				
Trittsicherheit		R10/A+B	R10/A+B				
Belastung							
quarz <input type="checkbox"/> V2	435492H Preisgr. A425 (St.)	435309H Preisgr. A422 (St.)	435317H Preisgr. A441 (St.)				
stein <input type="checkbox"/> V2	435493H Preisgr. A425 (St.)	435310H Preisgr. A422 (St.)	435318H Preisgr. A441 (St.)				
lava <input type="checkbox"/> V2	435494H Preisgr. A425 (St.)	435311H Preisgr. A422 (St.)	435319H Preisgr. A441 (St.)				
vulkan <input type="checkbox"/> V2	435495H Preisgr. A425 (St.)	435312H Preisgr. A422 (St.)	435320H Preisgr. A441 (St.)				
lehm <input type="checkbox"/> V2	435496H Preisgr. A425 (St.)	435313H Preisgr. A422 (St.)	435321H Preisgr. A441 (St.)				
ton <input type="checkbox"/> V2	435497H Preisgr. A425 (St.)	435314H Preisgr. A422 (St.)	435322H Preisgr. A441 (St.)				
kalk <input type="checkbox"/> V2	435498H Preisgr. A425 (St.)	435315H Preisgr. A422 (St.)	435323H Preisgr. A441 (St.)				
bims <input type="checkbox"/> V2	435499H Preisgr. A425 (St.)	435316H Preisgr. A422 (St.)	435324H Preisgr. A441 (St.)				



² Produktionsbedingte Farbabweichungen zum angrenzenden Belag bei liegender Verlegung sind nicht reklamationsfähig

Rendering







Urban, lässig, cool

Streetlife Metallic übersetzt das gute Gefühl gelebter Oberflächen in ein ausdrucksstarkes Fliesen-Design. Protagonisten der Serie: Rost-Oberflächen mit Schlieren, Oxidationsspuren und strahlender Lebendigkeit. Dazu eine weiche, wolkig changierende Optik, die an gebürstete Metalloberflächen erinnert. In Streetlife Metallic gehen beide eine kraftvolle Verbindung ein, die offenen Wohnkonzepten und moderner Loftarchitektur ein zeitloses, urbanes Feeling verleiht. Intensive, metallische Farben geben besonders echtem Holz, schimmernden Stoffen und Metall-Elementen eine Bühne. Mit Formaten von 60 x 60 und 60 x 120 cm und einer Stärke von 10,5 mm qualifiziert sich der zeitlose Bodenbelag auch für öffentliche Anwendungen wie z.B. Büroflächen oder Retail Design.

Rendering



rost

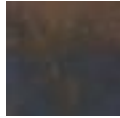

rostblau

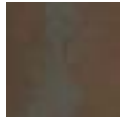

rostgrün

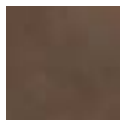

terra

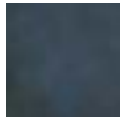

blaustahl

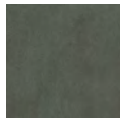

kupfergrün



Bodenfliese 60 x 60 cm, strukturiert, R10



Bodenfliese 60 x 120 cm, strukturiert, R10



Treppenfliese 30 x 120 cm (rilliert), strukturiert, R10



Sockel, geschnitten 6 x 60 cm, strukturiert

Bodenfliesen¹

Treppenfliese^{1/2}

Sockel, geschnitten¹

60 x 60 cm

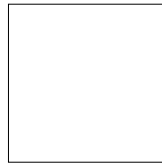

60 x 120 cm³

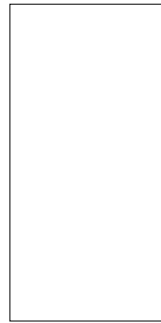

30 x 120 cm



6 x 60 cm



	B700HK	B770HK	B729HK	B710HK	
	60 x 60 / 24 x 24	60 x 120 / 24 x 48	30 x 120 / 12 x 48	6 x 60 / 2 3/8 x 24	Formatnummer
	597 x 597 x 10,5 mm	597 x 1197 x 10,5 mm	297 x 1197 x 10,5 mm	60 x 597 x 10,5 mm	Nennmaß - cm/in
	strukturiert, matt	strukturiert, matt	strukturiert, matt	strukturiert, matt	Herstellmaß
	2,778/m ²	1,389/m ²	0,833/m	1,667/m	Oberfläche
	23,335/m ²	23,821/m ²	6,427/m	1,445/m	m ² /m - Stück
	3	2	3	24	m ² /m - kg
	1,080 m ²	1,440 m ²	3,601 m	14,397 m	Paket - Stück
	25,200	34,300	23,148	20,808	Paket - m ² /m
	32,397	30,259			Paket - kg
	756,000	720,300			Palette - m ²
	Ala	Ala	Ala	Ala	Palette - kg
	R10/A+B	R10/A+B	R10/A+B		Produktnorm
	2	2	2	2	Trittsicherheit
	8823-B700HK	8823-B770HK	<i>8823-B729HK</i>	8823-B710HK	Belastung
	Preisgr. A154 (m ²)	Preisgr. A178 (m ²)	<i>Preisgr. A560 (St.)</i>	Preisgr. A438 (St.)	rost <input type="checkbox"/> V4
	8824-B700HK	8824-B770HK	<i>8824-B729HK</i>	8824-B710HK	rostblau <input type="checkbox"/> V4
	Preisgr. A154 (m ²)	Preisgr. A178 (m ²)	<i>Preisgr. A560 (St.)</i>	Preisgr. A438 (St.)	rostgrün <input type="checkbox"/> V4
	8825-B700HK	8825-B770HK	<i>8825-B729HK</i>	8825-B710HK	terra <input type="checkbox"/> V2
	Preisgr. A154 (m ²)	Preisgr. A178 (m ²)	<i>Preisgr. A560 (St.)</i>	Preisgr. A438 (St.)	blaustahl <input type="checkbox"/> V2
	8826-B700HK	8826-B770HK	<i>8826-B729HK</i>	8826-B710HK	kupfergrün <input type="checkbox"/> V2
	Preisgr. A154 (m ²)	Preisgr. A178 (m ²)	<i>Preisgr. A560 (St.)</i>	Preisgr. A438 (St.)	
	8827-B700HK	8827-B770HK	<i>8827-B729HK</i>	8827-B710HK	
	Preisgr. A154 (m ²)	Preisgr. A178 (m ²)	<i>Preisgr. A560 (St.)</i>	Preisgr. A438 (St.)	
	8828-B700HK	8828-B770HK	<i>8828-B729HK</i>	8828-B710HK	
	Preisgr. A154 (m ²)	Preisgr. A178 (m ²)	<i>Preisgr. A560 (St.)</i>	Preisgr. A438 (St.)	

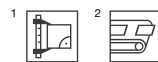

³ Hohes Gewicht! Karton bitte nur zu Zweit transportieren.



Verfügbar ab 2. Quartal 2025. (Ausnahme: die Artikel in der Farbe Rost)





Stimmiger Stilmix

Trio schlägt eine Brücke zwischen selten gewordenem Handwerk und moderner Fliesenfertigung. Im Mittelpunkt des Dreiklangs von Trio steht der Boden in natürlicher Zementstein-Optik: Lehm, Naturstein und Zement fließend übereinander geschichtet und durch farbige Steinchen aufgelockert. In den dekorativen Fliesen wird die Handwerkskunst des Terrazzo-Gusses aufgegriffen und in lebendigen Farben interpretiert. Die Form- und Farbvielfalt der Steinchen ergibt ein natürlich, lebhaftes Gesamtbild und setzt zarte Farbkontraste. Die Glasurfarben im 15 x 15 cm Kleinformat bilden gemeinsam mit der Zementstein- und Terrazzo-Optik der Serie einen kraftvollen Akkord. Die Farbpalette besteht aus einem klaren Weiß und drei ausdrucksvollen, leicht abgetönten Mischfarben.

Rendering



Wandfliese 30 x 60 cm, silk white, strukturiert



Wandfliese 30 x 90 cm, silk white, strukturiert

Dekorationselemente



Dekorfliese Terrazzo 30 x 60 cm, beige mix, strukturiert



Dekorfliese Terrazzo 30 x 90 cm, beige mix, strukturiert



R10/A+B

Made in Germany

Dekorationselemente



Dekorfliese Color
15 x 15 cm, brick, eben



Dekorfliese Color
15 x 15 cm, olive, eben

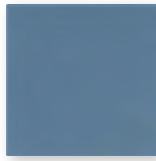

Dekorfliese Color
15 x 15 cm, aqua, eben

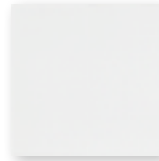

Dekorfliese Color
15 x 15 cm, platin, eben



Dekorfliese Lines
15 x 15 cm, brick,
reliefiert

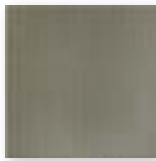

Dekorfliese Lines
15 x 15 cm, olive,
reliefiert



Dekorfliese Lines
15 x 15 cm, aqua,
reliefiert

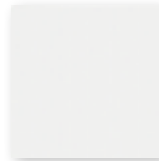

Dekorfliese Lines
15 x 15 cm, platin,
reliefiert

Mosaik 5 x 5 cm



Mosaikbogen 30 x 30 cm, ivory
white, strukturiert, R10/A+B

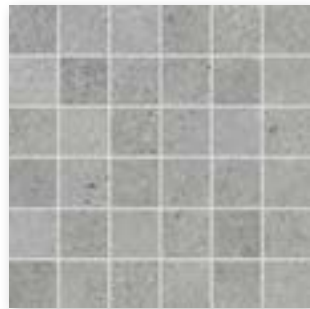

Mosaikbogen 30 x 30 cm, cement
grey, strukturiert, R10/A+B

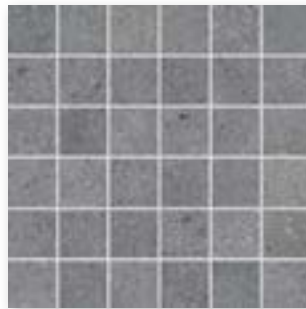

Mosaikbogen 30 x 30 cm, iron grey,
strukturiert, R10/A+B

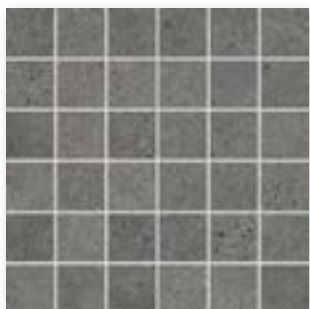

Mosaikbogen 30 x 30 cm, mud grey,
strukturiert, R10/A+B

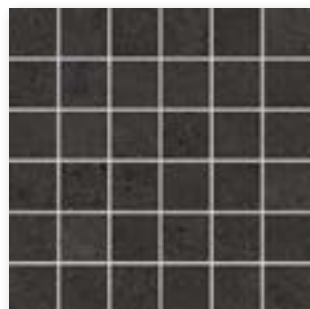

Mosaikbogen 30 x 30 cm, slate
black, strukturiert, R10/A+B

Mosaik: Verklebung rückseitig auf Glasfasernetz
Bogen: 297 x 297 mm

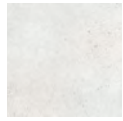

ivory white



cement grey



iron grey

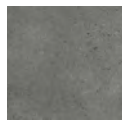

mud grey

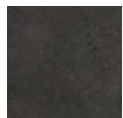

slate black



Bodenfliese 30 x 60 cm, strukturiert, R10/A+B



Bodenfliese 60 x 60 cm, strukturiert, R10/A+B



Bodenfliese 60 x 120 cm, strukturiert, R10/A+B



R10/A+B R11/B

Made in Germany



Treppenfiese 30 x 60 cm (rilliert), strukturiert, R10/A+B



Treppenfiese 30 x 120 cm (rilliert), strukturiert, R10/A+B



Sockel, gerundet 7 x 60 cm, strukturiert



Terrassenplatte 60 x 60 cm, ivory white, strukturiert, R11/B

ohne Abbildung:
 Terrassenplatte 120 x 120 cm, cement grey, strukturiert, R11/B
 Terrassenplatte 120 x 120 cm, slate black, strukturiert, R11/B



R10/A+B



terrazzo red



terrazzo black



terrazzo ivory



Bodenfliese Terrazzo 60 x 60 cm, strukturiert, R10/A+B



Bodenfliese Terrazzo 60 x 120 cm, strukturiert, R10/A+B

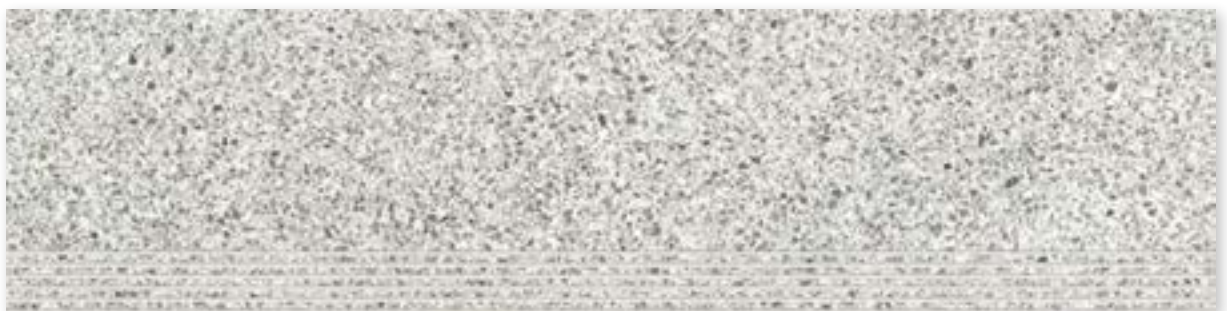

Treppenfliese Terrazzo 30 x 120 cm (rilliert), strukturiert, R10/A+B

Wandfliesen

Dekorationselemente⁴

30 x 60 m¹



30 x 90 cm³



30 x 60 cm

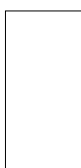

30 x 90 cm³



15 x 15 cm²



15 x 15 cm²



	Dekorfliese Terrazzo		Dekorfliese Terrazzo		Dekorfliese Color	Dekorfliese Lines	
	30 x 60 / 12 x 24	30 x 90 / 12 x 36	30 x 60 / 12 x 24	30 x 90 / 12 x 36	15 x 15 / 6 x 6	15 x 15 / 6 x 6	Nennmaß - cm/in
	297 x 597 x 6 mm	297 x 897 x 6 mm	297 x 597 x 6 mm	297 x 897 x 6 mm	147 x 147 x 6,5 mm	147 x 147 x 6,5 mm	Herstellmaß
	strukturiert, steinmatt	strukturiert, steinmatt	strukturiert, steinmatt	strukturiert, steinmatt	eben, matt	reliefiert, glänzend	Oberfläche
	5,556	3,704	5,556	3,704	44,444	44,444	m ² - Stück
	10,279	10,400	10,279	10,400	13,955	13,955	m ² - kg
	13	8	13	8	44	44	Paket - Stück
	2,340	2,160	2,340	2,160	0,990	0,990	Paket - m ²
	24,050	22,464	24,050	22,464	13,816	13,816	Paket - kg
	112,311	51,836	112,311	51,836	79,201	79,201	Palette - m ²
	1.154,400	539,136	1.154,400	539,136	1.105,280	1.105,280	Palette - kg
	BIII	BIII	BIII	BIII	BIa (GL)	BIa (GL)	Produktnorm
							Trittsicherheit
					1		Belastung
	203416H Preisgr. C107 (m ²)	323418H Preisgr. C149 (m ²)	203417H Preisgr. C116 (m ²)	323419H Preisgr. C155 (m ²)			silk white <input type="checkbox"/> V1
					133420H Preisgr. C152 (m ²)		beige mix <input type="checkbox"/> V4
						133424H Preisgr. C152 (m ²)	1 brick <input type="checkbox"/> V1
					133421H Preisgr. C152 (m ²)		brick <input type="checkbox"/> V2
						133425H Preisgr. C152 (m ²)	2 olive <input type="checkbox"/> V1
					133422H Preisgr. C152 (m ²)		olive <input type="checkbox"/> V2
						133426H Preisgr. C152 (m ²)	2 aqua <input type="checkbox"/> V1
					133423H Preisgr. C152 (m ²)		aqua <input type="checkbox"/> V2
						133427H Preisgr. C152 (m ²)	4 platin <input type="checkbox"/> V1
							platin <input type="checkbox"/> V2



⁴ Abgabe der Dekorationselemente ausschließlich in vollen Kartons.

Mosaik¹

5 x 5 cm⁵



Bodenfliesen¹

30 x 60 cm

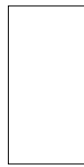

60 x 60 cm

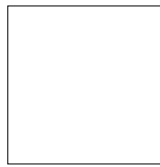

60 x 60 cm⁶

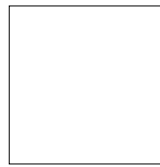

60 x 120 cm^{3/4}

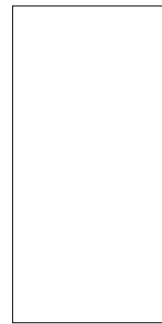

Treppenfliesen^{1/2}

30 x 60 cm



30 x 120 cm

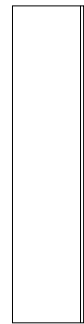

Bogen: 297 x 297 mm

überstark

Nennmaß - cm/in	5 x 5 / 2 x 2	30 x 60 / 12 x 24	60 x 60 / 24 x 24	60 x 60 / 24 x 24	60 x 120 / 24 x 48	30 x 60 / 12 x 24	30 x 120 / 12 x 48
Herstellmaß	47 x 47 x 9 mm	297 x 597 x 9 mm	597 x 597 x 9 mm	600 x 600 x 14 mm	597 x 1197 x 9 mm	297 x 597 x 9 mm	297 x 1197 x 9 mm
Oberfläche	strukturiert, matt	strukturiert, matt	strukturiert, matt	strukturiert, matt	strukturiert, matt	strukturiert, matt	strukturiert, matt
m ² /m - Stück	11,111 Bögen/m ²	5,556/m ²	2,778/m ²	2,778/m ²	1,388/m ²	1,667/m	0,833/m
m ² /m - kg	19,833/m ²	19,907/m ²	20,371/m ²	31,669/m ²	21,132/m ²	5,973/m	6,341/m
Paket - Stück	12 Bögen	7	3	2	2	7	3
Paket - m ² /m	1,080 m ²	1,260 m ²	1,080 m ²	0,720 m ²	1,441 m ²	4,199 m	3,601 m
Paket - kg	21,420	25,081	21,999	22,800	30,450	25,081	22,836
Palette - m ²	32,400	50,396	45,356	30,238	50,432		
Palette - kg	642,600	1.003,240	923,958	957,600	1,065,750		
Produktnorm	Bla	Bla	Bla	Bla	Bla	Bla	Bla
Trittsicherheit	R10/A+B	R10/A+B	R10/A+B	R10	R10/A+B	R10/A+B	R10/A+B
Belastung	2	2	2	4	2	2	2
ivory white <input type="checkbox"/> V3	431647H Preisgr. C293 (m ²)	431652H Preisgr. C125 (m ²)	431657H Preisgr. C140 (m ²)		431665H Preisgr. C152 (m ²)	<i>431677H</i> Preisgr. C474 (St.)	<i>431682H</i> Preisgr. C517 (St.)
cement grey <input type="checkbox"/> V3	431648H Preisgr. C293 (m ²)	431653H Preisgr. C125 (m ²)	431658H Preisgr. C140 (m ²)		431666H Preisgr. C152 (m ²)	<i>431678H</i> Preisgr. C474 (St.)	<i>431683H</i> Preisgr. C517 (St.)
iron grey <input type="checkbox"/> V3	431649H Preisgr. C293 (m ²)	431654H Preisgr. C125 (m ²)	431659H Preisgr. C140 (m ²)		431667H Preisgr. C152 (m ²)	<i>431679H</i> Preisgr. C474 (St.)	<i>431684H</i> Preisgr. C517 (St.)
mud grey <input type="checkbox"/> V3	431650H Preisgr. C293 (m ²)	431655H Preisgr. C125 (m ²)	431660H Preisgr. C140 (m ²)		431668H Preisgr. C152 (m ²)	<i>431680H</i> Preisgr. C474 (St.)	<i>431685H</i> Preisgr. C517 (St.)
slate black <input type="checkbox"/> V3	431651H Preisgr. C293 (m ²)	431656H Preisgr. C125 (m ²)	431661H Preisgr. C140 (m ²)		431669H Preisgr. C152 (m ²)	<i>431681H</i> Preisgr. C474 (St.)	<i>431686H</i> Preisgr. C517 (St.)
terrazzo red <input type="checkbox"/> V4			431662H Preisgr. C140 (m ²)	<i>431692H</i>	431695H Preisgr. C152 (m ²)		<i>431965H</i> Preisgr. C517 (St.)
terrazzo black <input type="checkbox"/> V4			431663H Preisgr. C140 (m ²)	<i>431693H</i>	431696H Preisgr. C152 (m ²)		<i>431966H</i> Preisgr. C517 (St.)
terrazzo ivory <input type="checkbox"/> V4			431664H Preisgr. C140 (m ²)	<i>431694H</i>	431697H Preisgr. C152 (m ²)		<i>431967H</i> Preisgr. C517 (St.)



- ³ Hohes Gewicht! Karton bitte nur zu Zweit transportieren.
- ⁴ Achtung! Sonderpalette. Keine Rücknahme, kein Umtausch.
- ⁵ Verklebung rückseitig auf Glasfasernetz
- ⁶ Preisstellungen werden objektspezifisch kalkuliert.

**Sockel,
gerundet¹**

7 x 60 cm



Terrassenplatten^{1/2}

60 x 60 cm

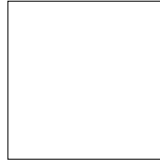

120 x 120 cm^{3/4}

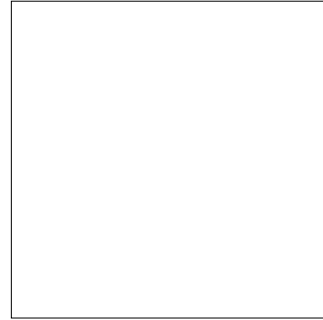

			7 x 60 / 2 13/16 x 24	60 x 60 / 24 x 24	120 x 120 / 48 x 48		Nennmaß - cm/in
			70 x 597 x 9 mm	597 x 597 x 20 mm	1198 x 1198 x 20 mm		Herstellmaß
			strukturiert, matt	strukturiert, matt	strukturiert, matt		Oberfläche
			1,667/m	2,778/m ²	0,694/m ²		m²/m - Stück
			1,357/m	45,273/m ²	46,567/m ²		m²/m - kg
			15	2	1		Paket - Stück
			8,998 m	0,720 m ²	1,440 m ²		Paket - m ² /m
			12,210	32,594	67,100		Paket - kg
				21,598	28,560		Palette - m ²
				977,820	1.342,000		Palette - kg
			Bla	Bla	Bla		Produktnorm
				R11/B	R11/B		Trittsicherheit
				4	4		Belastung
			431687H	431670H			ivory white <input type="checkbox"/> V3
			Preisgr. C440 (St.)	Preisgr. C200 (m ²)			
			431688H	431671H	431675		cement grey <input type="checkbox"/> V3
			Preisgr. C440 (St.)	Preisgr. C200 (m ²)	Preisgr. C260 (m ²)		
			431689H	431672H			iron grey <input type="checkbox"/> V3
			Preisgr. C440 (St.)	Preisgr. C200 (m ²)			
			431690H	431673H			mud grey <input type="checkbox"/> V3
			Preisgr. C440 (St.)	Preisgr. C200 (m ²)			
			431691H	431674H	431676		slate black <input type="checkbox"/> V3
			Preisgr. C440 (St.)	Preisgr. C200 (m ²)	Preisgr. C260 (m ²)		



¹

² Hohes Gewicht! Karton bitte nur zu Zweit transportieren.

³ ohne Hytect-Veredelung: mit Protecta-Vergütung

⁴ Achtung! Sonderpalette. Keine Rücknahme, kein Umtausch.







Ausdrucksstark und vielseitig

Mit acht Formaten, vier Farben und zwei Trittsicherheiten eignet sich die Serie Unique für viele Anwendungsbereiche. Das Farbspektrum der Protecta-vergüteten Feinsteinzeug-Bodenfliesen, das von Beige bis zu Anthrazit reicht, die leicht strukturierte, dezente Oberflächen sowie die Trittsicherheiten R10/A und R10/B ermöglichen einen vielseitigen Einsatz, auch im Nassbereich.

Firmensitz pbr Planungsbüro Rohling AG, Osnabrück, Deutschland
Architekt: pbr Planungsbüro Rohling AG, Osnabrück
Foto: Martin Lukas Kim Fotografie, Hamburg



R10/A R10/B



Made in Germany

Mosaik 5 x 5 cm

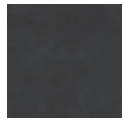

anthrazit



basalt



hellgrau

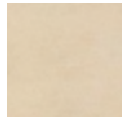

beige



Riegelformat 5 x 60 cm, eben, R10/A



Riegelformat 10 x 60 cm, eben, R10/A



Riegelformat 15 x 60 cm, eben, R10/A



Bodenfliese 30 x 30 cm, eben, R10/A



Bodenfliese 30 x 60 cm, eben, R10/A

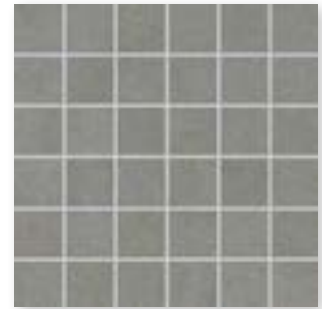

Mosaikbogen 30 x 30, strukturiert, R10/B



R10/A



Bodenfliese 60 x 60 cm, eben, R10/A



Treppenfliese 30 x 60 cm (rilliert), eben, R10/A

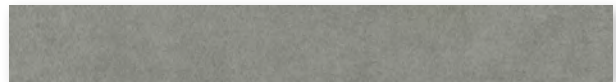

Sockel, gerundet 7 x 60 cm, eben



Bodenfliese 60 x 120 cm, eben, R10/A

Mosaik^{1/3}

Bodenfliesen¹

5 x 5 cm



5 x 60 cm²



10 x 60 cm²



15 x 60 cm²



30 x 30 cm



30 x 60 cm



protected

Bogen: 297x297 mm

Riegelformat

Riegelformat

Riegelformat

Nennmaß - cm/in	5 x 5 / 2 x 2	5 x 60 / 2 x 24	10 x 60 / 4 x 24	15 x 60 / 6 x 24	30 x 30 / 12 x 12	30 x 60 / 12 x 24	
Herstellmaß	47 x 47 x 10,5 mm	47 x 597 x 10,5 mm	97 x 597 x 10,5 mm	147 x 597 x 10,5 mm	297 x 297 x 10,5 mm	297 x 597 x 10,5 mm	
Oberfläche	strukturiert, matt	eben, matt	eben, matt	eben, matt	eben, matt	eben, matt	
m ² - Stück	11,111	33,333	16,667	11,111	11,111	5,556	
m ² - kg	21,966	21,966	21,967	21,966	21,966	21,974	
Paket - Stück	11 Bögen	33	15	11	11	6	
Paket - m ²	0,990	0,990	0,900	0,990	0,990	1,080	
Paket - kg	21,747	21,747	19,770	21,747	21,747	23,730	
Palette - m ²	29,700	39,600	35,999	39,600	41,580	43,197	
Palette - kg	652,410	869,880	790,800	869,880	913,374	949,200	
Produktnorm	Alb	Alb	Alb	Alb	Alb	Alb	
Trittsicherheit	R10/B	R10/A	R10/A	R10/A	R10/A	R10/A	
Belastung	2	2	2	2	2	2	
anthrazit <input type="checkbox"/>	433793 Preisgr. A265 (m ²)	433787 Preisgr. A211 (m ²)	433770 Preisgr. A211 (m ²)	433778 Preisgr. A199 (m ²)	433841 Preisgr. A115 (m ²)	433671 Preisgr. A127 (m ²)	
basalt <input type="checkbox"/>	433794 Preisgr. A265 (m ²)	433786 Preisgr. A211 (m ²)	433771 Preisgr. A211 (m ²)	433779 Preisgr. A199 (m ²)	433842 Preisgr. A115 (m ²)	433672 Preisgr. A127 (m ²)	
hellgrau <input type="checkbox"/>	433795 Preisgr. A265 (m ²)	433789 Preisgr. A211 (m ²)	433772 Preisgr. A211 (m ²)	433780 Preisgr. A199 (m ²)	433843 Preisgr. A115 (m ²)	433673 Preisgr. A127 (m ²)	
beige <input type="checkbox"/>	433796 Preisgr. A265 (m ²)	433891 Preisgr. A211 (m ²)	433773 Preisgr. A211 (m ²)	433781 Preisgr. A199 (m ²)	433844 Preisgr. A115 (m ²)	433674 Preisgr. A127 (m ²)	

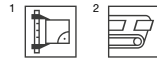

³ Verklebung rückseitig auf Glasfasernetz

Bodenfliesen¹

Treppen-
fliese^{1/2}

Sockel,
gerundet¹

60 x 60 cm

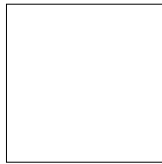

60 x 120 cm³



30 x 60 cm



7 x 60 cm



protected

			60 x 60 / 24 x 24	60 x 120 / 24 x 48	30 x 60 / 12 x 24	7 x 60 / 2 13/16 x 24	Nennmaß - cm/in
			597 x 597 x 10,5 mm	597 x 1197 x 8 mm	297 x 597 x 10,5 mm	70 x 597 x 10,5 mm	Herstellmaß
			eben, matt	eben, matt	eben, matt	eben, matt	Oberfläche
			2,778/m ²	1,388/m ²	1,667/m	1,667/m	m ² /m - Stück
			21,996/m ²	17,489/m ²	6,593/m	1,554/m	m ² /m - kg
			3	2	6	15	Paket - Stück
			1,080 m ²	1,441 m ²	3,599 m	8,998 m	Paket - m ² /m
			23,754	25,200	23,730	13,980	Paket - kg
			32,397	36,023			Palette - m ²
			712,620	630,000			Palette - kg
			Alb	Alb	Alb	Alb	Produktnorm
			R10/A	R10/A	R10/A		Trittsicherheit
			2	2	2		Belastung
			433701	434432	433678	433685	
			Preisgr. A142 (m ²)	Preisgr. A169 (m ²)	Preisgr. A465 (St.)	Preisgr. A441 (St.)	anthrazit <input type="checkbox"/> V2
			433702	434433	433679	433686	
			Preisgr. A142 (m ²)	Preisgr. A169 (m ²)	Preisgr. A465 (St.)	Preisgr. A441 (St.)	basalt <input type="checkbox"/> V2
			433703	434434	433680	433687	
			Preisgr. A142 (m ²)	Preisgr. A169 (m ²)	Preisgr. A465 (St.)	Preisgr. A441 (St.)	hellgrau <input type="checkbox"/> V2
			433704	434435	433681	433688	
			Preisgr. A142 (m ²)	Preisgr. A169 (m ²)	Preisgr. A465 (St.)	Preisgr. A441 (St.)	beige <input type="checkbox"/> V2

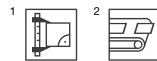

³ Hohes Gewicht! Karton bitte nur zu Zweit transportieren.







Natürlich und lebhaft

Die Feinsteinzeugserie Valley wurde inspiriert vom Panorama der weit entfernten Landschaft einer Talebene. Davon zeugen ihr erdiges Relief und ihre feinen, körnigen Strukturverläufe. Jede Farbe weckt unterschiedliche Assoziationen: an Blau- oder Tonschiefer, Flusskiesel, Sand und Erde. Witterungseinflüsse, Erdbewegungen, Wasserflüsse und metallische Materialeinlagerungen zeichnen zusätzlich eine lebendige Oberfläche typischer „Berg-Tal-Wirkung“. Die Serie wird abgerundet durch eine überstarke, frostsichere Terrassenplatte in allen vier Farben, die auch zur Verlegung in Sand oder Kies geeignet ist.

Wellness Hostel 4000, Sas Fee, Schweiz / Architekt: Steinmann & Schmid Arch. AG BSA SIA / Foto: Adriano Faragulo



R10/A R10/B R11/B



schiefer



kieselgrau

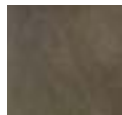

erdbraun



sandbeige

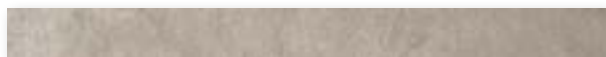

Riegelformat 5 x 60 cm, strukturiert, R10/A



Riegelformat 10 x 60 cm, strukturiert, R10/A



Riegelformat 15 x 60 cm, strukturiert, R10/A



Riegelformat 20 x 60 cm, strukturiert, R10/A

Mosaik 5 x 5 cm



Mosaikbogen 30 x 30 cm, eben, R11/B



Boden-/Wandfliese 15 x 15 cm
strukturiert, R10/B

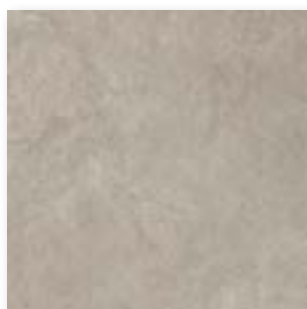

Boden-/Wandfliese 30 x 30 cm
strukturiert, R11/B



Boden-/Wandfliese 30 x 60 cm, strukturiert, R10/A
Boden-/Wandfliese 30 x 60 cm, strukturiert, R11/B



Bodenfliese 60 x 60 cm, strukturiert, R10/A
Terrassenplatte 60 x 60 cm, strukturiert, R11/B

Keramische Rinnenabdeckung,
25 x 50 cm



Keramische Rinnenabdeckung,
Ecklösung 30 x 30 cm

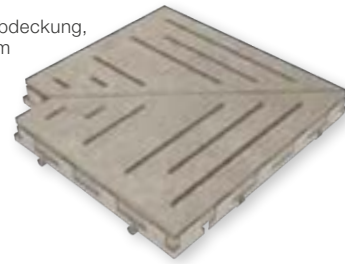

Details zu Keramischer Rinnenabdeckung siehe
Lieferprogramm Pool+Spa.



Bodenfliese 60 x 120 cm, strukturiert, R10/A



Sockel, gerundet 7 x 60 cm



Treppenfliese 30 x 60 cm (rilliert), strukturiert, R10/A

Mosaik^{1/3}

Boden-/Wandfliesen¹

5 x 5 cm



15 x 15 cm



5 x 60 cm²



10 x 60 cm²



15 x 60 cm²



20 x 60 cm²



protected

Bogen: 297 x 297 mm

Riegelformat

Riegelformat

Riegelformat

Riegelformat

Nennmaß - cm/in	5 x 5 / 2 x 2	15 x 15 / 6 x 6	5 x 60 / 2 x 24	10 x 60 / 4 x 24	15 x 60 / 6 x 24	20 x 60 / 8 x 24
Herstellmaß	47 x 47 x 10 mm	147 x 147 x 8 mm	46 x 596 x 10 mm	96 x 596 x 10 mm	146 x 596 x 10 mm	196 x 596 x 10 mm
Oberfläche	strukturiert, matt	strukturiert, matt	strukturiert, matt	strukturiert, matt	strukturiert, matt	strukturiert, matt
m ² - Stück	11,111	44,444	33,333	16,667	11,111	8,333
m ² - kg	21,800	17,555	22,233	22,667	22,000	23,749
Paket - Stück	11 Bögen	35	33	15	11	8
Paket - m ²	0,990	0,788	0,990	0,900	0,990	0,960
Paket - kg	21,582	13,825	22,011	20,400	21,780	22,800
Palette - m ²	29,700	63,001	39,600	35,999	39,600	40,322
Palette - kg	647,460	1.106,000	880,440	816,000	871,200	957,600
Produktnorm	Bla	Bla	Bla	Bla	Bla	Bla
Trittsicherheit	R11/B	R10/B	R10/A	R10/A	R10/A	R10/A
Belastung	2	2	2	2	2	2
schiefer <input type="checkbox"/> V2	052089 Preisgr. A292 (m ²)	052477 Preisgr. A142 (m ²)	052044 Preisgr. A217 (m ²)	052048 Preisgr. A217 (m ²)	052052 Preisgr. A211 (m ²)	052461 Preisgr. A211 (m ²)
kieselgrau <input type="checkbox"/> V2	052090 Preisgr. A292 (m ²)	052478 Preisgr. A142 (m ²)	052045 Preisgr. A217 (m ²)	052049 Preisgr. A217 (m ²)	052053 Preisgr. A211 (m ²)	052462 Preisgr. A211 (m ²)
erdbraun <input type="checkbox"/> V2	052091 Preisgr. A292 (m ²)	052479 Preisgr. A142 (m ²)	052046 Preisgr. A217 (m ²)	052050 Preisgr. A217 (m ²)	052054 Preisgr. A211 (m ²)	052463 Preisgr. A211 (m ²)
sandbeige <input type="checkbox"/> V2	052092 Preisgr. A292 (m ²)	052480 Preisgr. A142 (m ²)	052047 Preisgr. A217 (m ²)	052051 Preisgr. A217 (m ²)	052055 Preisgr. A211 (m ²)	052464 Preisgr. A211 (m ²)



Boden-/Wandfliesen¹

30 x 30 cm



30 x 60 cm



30 x 60 cm



60 x 60 cm



60 x 120 cm^{4/5}



protected

Nennmaß - cm/in	30 x 30 / 12 x 12	30 x 60 / 12 x 24	30 x 60 / 12 x 24	60 x 60 / 24 x 24	60 x 120 / 24 x 48
Herstellmaß	297 x 297 x 10 mm	297 x 596 x 10 mm	297 x 596 x 10 mm	596 x 596 x 10 mm	596 x 1195 x 10,5 mm
Oberfläche	strukturiert, matt	strukturiert, matt	strukturiert, matt	strukturiert, matt	strukturiert, matt
m ² - Stück	11,111	5,556	5,556	2,778	1,388
m ² - kg	23,144	22,780	22,780	22,780	23,180
Paket - Stück	11	6	6	3	2
Paket - m ²	0,990	1,080	1,080	1,080	1,441
Paket - kg	22,913	24,600	24,600	24,600	33,400
Palette - m ²	41,580	43,197	43,197	43,197	50,432
Palette - kg	962,346	984,000	984,000	984,000	1.169,000
Produktnorm	Bla	Bla	Bla	Bla	Bla
Trittsicherheit	R11/B	R10/A	R11/B	R10/A	R10/A
Belastung	3	2	2	3	2
schiefer <input type="checkbox"/> V2	052032 Preisgr. A121 (m ²)	052016 Preisgr. A109 (m ²)	052036 Preisgr. A121 (m ²)	052020 Preisgr. A121 (m ²)	052024 Preisgr. A154 (m ²)
kieselgrau <input type="checkbox"/> V2	052033 Preisgr. A121 (m ²)	052017 Preisgr. A109 (m ²)	052037 Preisgr. A121 (m ²)	052021 Preisgr. A121 (m ²)	052025 Preisgr. A154 (m ²)
erdbraun <input type="checkbox"/> V2	052034 Preisgr. A121 (m ²)	052018 Preisgr. A109 (m ²)	052038 Preisgr. A121 (m ²)	052022 Preisgr. A121 (m ²)	052026 Preisgr. A154 (m ²)
sandbeige <input type="checkbox"/> V2	052035 Preisgr. A121 (m ²)	052019 Preisgr. A109 (m ²)	052039 Preisgr. A121 (m ²)	052023 Preisgr. A121 (m ²)	052027 Preisgr. A154 (m ²)

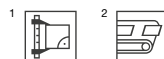

³ Verklebung rückseitig auf Glasfasernetz

⁴ Hohes Gewicht! Karton bitte nur zu Zweit transportieren.

⁵ Achtung: Sonderpalette. Keine Rücknahme, kein Umtausch.

Treppen-
fliese^{1/2}

30 x 60 cm

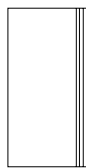

Sockel,
gerundet¹

7 x 60 cm



Terrassen-
platte^{1/3}

60 x 60 cm

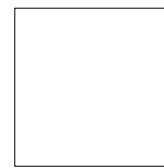

protected

				30 x 60 / 12 x 24	7 x 60 / 2 13/16 x 24	60 x 60 / 24 x 24	Nennmaß - cm/in
				297 x 596 x 10 mm	70 x 596 x 10 mm	596 x 596 x 20 mm	Herstellmaß
				strukturiert, matt	strukturiert, matt	strukturiert, matt	Oberfläche
				1,667/m	1,667/m	2,778/m ²	m ² /m - Stück
				6,968/m	1,550/m	46,948/m ²	m ² /m - kg
				6	22	2	Paket - Stück
				3,599 m	13,197 m	0,720 m ²	Paket - m ² /m
				25,080	20,460	33,800	Paket - kg
						21,598	Palette - m ²
						1.014,000	Palette - kg
				Bla	Bla	Bla	Produktnorm
				R10/A		R11/B	Trittsicherheit
				2		4	Belastung
				052068	052072	052085	
				Preisgr. A475 (St.)	Preisgr. A438 (St.)	Preisgr. A178 (m ²)	schiefer <input type="checkbox"/> V2
				052069	052073	052086	
				Preisgr. A475 (St.)	Preisgr. A438 (St.)	Preisgr. A178 (m ²)	kieselgrau <input type="checkbox"/> V2
				052070	052074	052087	
				Preisgr. A475 (St.)	Preisgr. A438 (St.)	Preisgr. A178 (m ²)	erdbraun <input type="checkbox"/> V2
				052071	052075	052088	
				Preisgr. A475 (St.)	Preisgr. A438 (St.)	Preisgr. A178 (m ²)	sandbeige <input type="checkbox"/> V2



³ Hohes Gewicht! Karton bitte nur zu Zweit transportieren.





Kraftvoll, entspannt und zeitlos

Walden ist ein klassisches, naturgetreues Holzdesign gefertigt in hochwertiger Keramik. Ein natürliches Produkt, das die Beliebtheit von authentischen Holzoberflächen mit den Vorteilen keramischer Belagsmaterialien verbindet. Die 5 Farbtöne im klassischen Dielenformat 20 x 120 cm bedienen ein weites Spektrum unterschiedlichster Stilrichtungen und lassen sich je nach Wunsch harmonisch oder kontrastreich mit anderen Materialien kombinieren. Die Trittsicherheit R10/A+B sorgt für vielseitige Anwendungsmöglichkeiten im privaten und öffentlichen Interieur.

Rendering



R10/A+B



sunny white



relax beige



classic oak



brown cherry



smokey brown



Bodenfliese 20 x 120 cm, strukturiert, R10/A+B



Sockel, gerundet 6 x 60 cm, strukturiert

Bodenfliese^{1/2} Sockel, gerundet¹

20 x 120 cm



6 x 60 cm



protected

					20 x 120 / 8 x 48	6 x 60 / 2 3/8 x 24	Nennmaß - cm/in
					197 x 1195 x 9 mm	60 x 596 x 9 mm	Herstellmaß
					strukturiert, matt	strukturiert, matt	Oberfläche
					4,166/m ²	1,667/m	m ² /m - Stück
					20,830/m ²	1,237/m	m ² /m - kg
					6	27	Paket - Stück
					1,440 m ²	16,197 m	Paket - m ² /m
					30,000	20,034	Paket - kg
					60,490		Palette - m ²
					1.260,000		Palette - kg
					Bla	Bla	Produktnorm
					R10/A+B		Trittsicherheit
					2		Belastung
					430685	430690	
					Preisgr. C143 (m ²)	Preisgr. C437 (St.)	sunny white <input type="checkbox"/> V2
					430686	430691	
					Preisgr. C143 (m ²)	Preisgr. C437 (St.)	relax beige <input type="checkbox"/> V2
					430687	430692	
					Preisgr. C143 (m ²)	Preisgr. C437 (St.)	classic oak <input type="checkbox"/> V2
					430688	430693	
					Preisgr. C143 (m ²)	Preisgr. C437 (St.)	brown cherry <input type="checkbox"/> V2
					430689	430694	
					Preisgr. C143 (m ²)	Preisgr. C437 (St.)	smokey brown <input type="checkbox"/> V2



² Achtung: Sonderpalette. Keine Rücknahme, kein Umtausch.





Inhalt

• Artikelnummern	500 - 510
• Formate	511 - 512
• Formatnummern	513
• Zuordnungen NCS/RAL / Hellbezugswerte	514 - 515
• Leuchtdichtekontrast	516 - 519
Technische Informationen	520 - 539
Vertriebskontakte D-A-CH	542 - 543
Erläuterungen	546 - 547



Alle Artikelnummern zu unseren Beckenkopf-systemen und Bäderformteilen finden Sie ab sofort in unserem Lieferprogramm Pool + Spa.

Artikel-Nr.	Seite	Artikel-Nr.	Seite	Artikel-Nr.	Seite	Artikel-Nr.	Seite	Artikel-Nr.	Seite	Artikel-Nr.	Seite
0002	301	052480	492	130-1050H	346	182763	107	203416H	479	239996	107
010D-1010	291	101630-6635	127	130-1111H	344	182764	107	203417H	479	239997	107
010D-1630	291	101630-6636	127	130-1112H	344	183343	107	203431H	454	239998	107
052016	492	103197-6635	127	130-1113H	344	183344	107	203432H	454	240-1001H	344
052017	492	103197-6636	127	130-1115H	344	19020-2290H	181	203433H	454	240-1002H	344
052018	492	111052	107	130-1117H	344	19020-2320H	181	203434H	454	240-1003H	344
052019	492	112000	107	130-1118H	344	19020-9215H	181	203435H	44	240-1004H	344
052020	492	113063	107	130-1119H	344	19021-2290H	181	203436H	44	240-1005H	344
052021	492	115100	107	130-1120H	344	19021-2320H	181	203439	44	240-1006H	344
052022	492	130-1001H	344	130-1121H	344	19021-9215H	181	203440	44	240-1007H	344
052023	492	130-1002H	344	133420H	479	19022-2290H	181	203441	44	240-1008H	344
052024	492	130-1003H	344	133421H	479	19022-2320H	181	203442	44	240-1009H	344
052025	492	130-1004H	344	133422H	479	19022-9215H	181	203443	44	240-1010H	344
052026	492	130-1005H	344	133423H	479	19024-2290H	181	203444	108	240-1011H	344
052027	492	130-1006H	344	133424H	479	19024-2320H	181	203445	108	240-1012H	344
052032	492	130-1007H	344	133425H	479	19024-9215H	181	203459R	108	240-1013H	344
052033	492	130-1008H	344	133426H	479	19025-2290H	181	203460R	108	240-1014H	344
052034	492	130-1009H	344	133427H	479	19025-2320H	181	203461HR	109	240-1015H	344
052035	492	130-1010H	344	144-12020	149	19025-9215H	181	203462HR	109	240-1016H	344
052036	492	130-1011H	344	144-12050	149	19026-2290H	181	203479H	214	240-1017H	345
052037	492	130-1012H	344	144-18120	149	19026-2320H	181	203480H	214	240-1018H	345
052038	492	130-1013H	344	144-18210	149	19026-9215H	181	203481H	214	240-1019H	345
052039	492	130-1014H	344	144-41550K	149	19027-2290H	181	203482H	214	240-1020H	345
052044	492	130-1015H	344	144-42550K	149	19027-2320H	181	203505H	420	240-1021H	345
052045	492	130-1016H	344	150i-12020H	149	19027-9215H	181	203506H	420	240-1022H	345
052046	492	130-1017H	345	150i-12050H	149	19030-2290H	181	203507H	420	240-1023H	345
052047	492	130-1018H	345	150i-18120H	149	19030-2320H	181	203508H	420	240-1024H	345
052048	492	130-1019H	345	150i-18210H	149	19030-9215H	181	203509H	420	240-1025H	345
052049	492	130-1020H	345	150i-41550HK	149	19031-2290H	181	203510H	420	240-1026H	345
052050	492	130-1021H	345	150i-42550HK	149	19031-2320H	181	203511	437	240-1027H	345
052051	492	130-1022H	345	151i-12020H	149	19031-9215H	181	203512	437	240-1028H	345
052052	492	130-1023H	345	151i-12050H	149	19032-2290H	181	203513	437	240-1029H	345
052053	492	130-1024H	345	151i-18120H	149	19032-2320H	181	203514	437	240-1030H	345
052054	492	130-1025H	345	151i-18210H	149	19032-9215H	181	203515	437	240-1031H	345
052055	492	130-1026H	345	151i-41550HK	149	19033-2290H	181	203516	437	240-1032H	345
052068	493	130-1027H	345	151i-42550HK	149	19033-2320H	181	203517	437	240-1033H	345
052069	493	130-1028H	345	152i-12020H	149	19033-9215H	181	203518	437	240-1034H	345
052070	493	130-1029H	345	152i-12050H	149	203225H	84	203519	437	240-1035H	345
052071	493	130-1030H	345	152i-18120H	149	203226H	84	203520	437	240-1036H	345
052072	493	130-1031H	345	152i-18210H	149	203229H	84	203521	437	240-1037H	345
052073	493	130-1032H	345	152i-41550HK	149	203232H	66	203522	437	240-1038H	345
052074	493	130-1033H	345	152i-42550HK	149	203233H	66	203523	437	240-1039H	345
052075	493	130-1034H	345	153i-12020H	149	203234H	66	203524	437	240-1040H	345
052085	493	130-1035H	345	153i-12050H	149	203264	108	203525	437	240-1111H	344
052086	493	130-1036H	345	153i-18120H	149	203265	108	203526	437	240-1112H	344
052087	493	130-1037H	345	153i-18210H	149	203266H	109	203527	437	240-1113H	344
052088	493	130-1038H	345	153i-41550HK	149	203267H	109	203528	437	240-1115H	344
052089	492	130-1039H	345	153i-42550HK	149	203331H	391	213341	107	240-1117H	344
052090	492	130-1040H	345	154i-12020H	149	203333H	84	213342	107	240-1118H	344
052091	492	130-1041H	346	154i-12050H	149	203392H	271	2203-B600HK	245	240-1119H	344
052092	492	130-1042H	346	154i-18120H	149	203393H	271	2204-B600HK	245	240-1120H	344
052461	492	130-1043H	346	154i-18210H	149	203394H	271	2205-B600HK	245	240-1121H	344
052462	492	130-1044H	346	154i-41550HK	149	203408	398	2206-B600HK	245	2401RH-K100-21	189
052463	492	130-1045H	346	154i-42550HK	149	203409	398	2207-B600HK	245	2452	233
052464	492	130-1046H	346	173339	107	203410	398	2208-B600HK	245	2455	233
052477	492	130-1047H	346	173340	107	203411	398	231032	107	280345	171
052478	492	130-1048H	346	173368	107	203412H	398	231034	107	280349-73	171
052479	492	130-1049H	346	173369	107	203413H	398	239995	107	280350-73	171

Artikel-Nr.	Seite	Artikel-Nr.	Seite	Artikel-Nr.	Seite	Artikel-Nr.	Seite	Artikel-Nr.	Seite	Artikel-Nr.	Seite
280351-73	171	340i-32027H	155	363354H	454	41204H	232	41455H	234	430117H	76
280354	171	340i-32050H	153	363355H	454	41205H	232	41456H	234	430185H	66
280360	171	340i-32055H	155	363356	454	41206H	232	41457H	234	430186H	66
280361	171	340i-32057H	155	363357	454	41207H	232	41505	233	430187H	66
280362	171	340i-38110H	153	363358	454	41208H	232	41509	233	430188H	66
280374	108	340i-38115H	155	363359	454	41209H	232	41510	233	430189H	66
280375	108	340i-38116H	155	363414H	398	41210H	232	41513	233	430190H	66
280718	108	340i-38117H	155	363415H	398	41211H	232	41520H	232	430200H	69, 298
280719	108	340i-38118H	155	363428H	131	41212H	232	41920H	49	430201H	69, 298
280871	108	355S-1110	189	363429H	131	41213H	232	41921H	49	430202H	69, 298
280872	108	355S-4000	189	363430H	131	41214H	232	41922H	49	430212H	72
281476	337	355S-4003	189	391572	109	41215H	232	41923H	49	430212H-TF	72
281477	337	355S-4004	189	391573	109	41216H	233	41924H	49	430212H-TK	73
281479	337	360-1001H	344	391589	108	41217H	233	41925H	49	430214H	69
281480	337	360-1002H	344	391590	108	41218H	233	41926H	49	430215H	69
281726	138	360-1003H	344	392720	138	41219H	233	41927H	49	430216H	69
281727	138	360-1004H	344	392721	138	41220H	233	41928H	49	430217H	69
281728	138	360-1005H	344	392723	138	41221H	233	41929H	49	430218H	69
281729	138	360-1006H	344	392724	138	41222H	233	41930H	49	430219H	69
281730	138	360-1007H	344	392725	138	41223H	233	42000H	331	430220H	66
281731	138	360-1008H	344	392726	138	41300H	234	42001H	331	430221H	66
281732	138	360-1009H	344	392727	138	41301H	234	42002H	331	430222H	66
281733	138	360-1010H	344	392728	138	41302H	234	42010H	331	430223H	66
282115R-02	108	360-1011H	344	393104H	207	41303H	234	42020H	331	430224H	66
282116R-02	108	360-1012H	344	393105H	207	41304H	234	42100H	332	430225H	66
282887R	109	360-1013H	344	393127H	207	41305H	234	42101H	332	430226H	66
282888R	109	360-1014H	344	40000H	261	41306H	234	42102H	332	430227H	66
282901	277	360-1015H	344	40001H	261	41307H	234	42103H	332	430228H	66
282902	277	360-1016H	344	40002H	261	41308H	234	42120H	332	430229H	66
282903	277	360-1017H	345	40003H	261	41309H	234	42121H	332	430230H	66
283102HR	207	360-1018H	345	40004H	261	41310H	234	42130H	332	430231H	66
283103HR	207	360-1019H	345	40005H	261	41311H	234	42200H-73	103	430232H	66
283126HR	207	360-1020H	345	40006H	261	41312H	234	42201H-73	103	430233H	66
283345	108	360-1021H	345	40007H	261	41313H	234	42202H-73	103	430234H	66
283346	108	360-1022H	345	40008H	261	41314H	234	42203H-73	103	430235H	66
289358	109	360-1023H	345	40009H	261	41315H	234	42204H-73	103	430236H	66
289359	109	360-1024H	345	40010H	261	41316H	234	42400H	331	430237H	66
289360	109	360-1025H	345	40011H	261	41317H	234	42401H	331	430238H	66
289361	109	360-1026H	345	40012H	261	41318H	234	42402H	331	430239H	66
3201H	391	360-1027H	345	40013H	261	41319H	234	42500H	331	430240H	66
3202H	391	360-1028H	345	40014	261	41320H	234	42501H	331	430241H	66
3203H	391	360-1029H	345	40020H	261	41321H	234	42502H	331	430242H	66
3206H	391	360-1030H	345	40021H	261	41322H	234	42503H	331	430243H	66
3221H	391	360-1031H	345	40022H	261	41323H	234	430064H	71	430244H	67
3222H	391	360-1032H	345	40023H	261	41400H-73	234	430065H	71	430245H	67
3227	391	360-1033H	345	40024H	261	41401H-73	234	430066H	71	430246H	67
3228H	391	360-1034H	345	40025H	261	41402H-73	234	430067H	71	430248H	72
323227H	84	360-1035H	345	40026H	261	41403H-73	234	430068H	71	430249H	67
323228H	84	360-1036H	345	40027H	261	41404H-73	234	430069H	71	430250H	67
323230H	84	360-1037H	345	40028H	261	41405H-73	234	430070H	71	430253H	67
323235H	66	360-1038H	345	40029H	261	41406H	234	430071H	71	430256H	67
323236H	66	360-1039H	345	40030H	261	41407H	234	430072H	71	430257H	67
323237H	66	360-1040H	345	40031H	261	41408H	234	430073H	71	430258H	67
323260	108	360-1041H	346	40032H	261	41409H	234	430074H	71	430261H	67
323261	108	360-1042H	346	40033H	261	41410H	234	430075H	71	430262H	67
323262H	109	360-1043H	346	40034	261	41411H	234	430080H	73	430265H	67
323263H	109	360-1044H	346	40040H	262	41412H	234	430081H	73	430268H	67
323332H	391	360-1045H	346	40041H	262	41413H	234	430082H	73	430269H	67
323395H	271	360-1046H	346	40042H	262	41414H	234	430083H	73	430270H	67
323396H	271	360-1047H	346	40044H	262	41415H	234	430084H	73	430271H	67
323397H	271	360-1048H	346	40047H	262	41420H	234	430085H	73	430272H	67
323418H	479	360-1049H	346	40048H	262	41421H	234	430086H	73	430273H	67
323419H	479	360-1050H	346	40056H	261	41422H	234	430087H	73	430274H	67
323437H	44	360-1111H	344	40057H	261	41423H	234	430088H	73	430275H	67
323438H	44	360-1112H	344	40071H	262	41424H	234	430089H	73	430276H	67
323483H	214	360-1113H	344	410-2008	370	41425H	234	430090H	73	430277H	67
323484H	214	360-1115H	344	410-2016	370	41426H	234	430091H	73	430278H	67
323485H	214	360-1117H	344	410-2023	370	41427H	234	430093H	76	430279H	67
323486H	214	360-1118H	344	410-2033	370	41428H	234	430093H-RE	77	430280H	67
3251H	391	360-1119H	344	410-2038	370	41429H	234	430093H-RER	77	430281H	67
3252H	391	360-1120H	344	410-2039	370	41430H	234	430093H-RERZ	77	430282H	67
3258H	391	360-1121H	344	410-2040	370	41431H	234	430093H-RZ	77	430283H	67
3303H	391	363335	108	410-2041	370	41432H	234	430093H-SE	77	430284H	67
3304H	391	363336	108	410-2042	370	41433H	234	430093H-SZ	77	430285H	67
3305H	391	363347H	283	410-2043	370	41434H	234	430094H	76	430286H	67
3306	391	363348H	283	410-2111	370	41435H	234	430095H	76	430287H	67
3314H	391	363349H	283	410-2113	370	41450H	234	430096H	76	430288H	67
3353H	391	363350H	283	41200H	232	41451H	234	430097H	76	430289H	67
3354H	391	363351H	283	41201H	232	41452H	234	430098H	76	430290H	67
340i-32020H	153	363352H	454	41202H	232	41453H	234	430115H	76	430291H	67
340i-32025H	155	363353H	454	41203H	232	41454H	234	430116H	76	430292H	68

Artikel-Nr.	Seite	Artikel-Nr.	Seite	Artikel-Nr.	Seite	Artikel-Nr.	Seite	Artikel-Nr.	Seite	Artikel-Nr.	Seite
430293H	68	430355H	68	430416H	69	430497H	70	430660	254	430757H	96
430294H	68	430356H	68	430417H	69	430498H	70	430661	254	430758H	96
430295H	68	430357H	68	430418H	69	430499H	70	430662	254	430759H	96
430296H	68	430358H	68	430419H	69	430500H	70	430663	254	430760H	96
430297H	68	430359H	68	430420H	69	430501H	70	430664	254	430761H	96
430298H	68	430360H	68	430421H	69	430502H	70	430665	255	430762H	96
430299H	68	430361H	68	430422	70	430503H	70	430666	255	430763H	96
430300H	68	430362H	68	430423	70	430504H	72	430667	255	430764H	96
430301H	68	430363H	68	430424	70	430505H	72	430668	255	430765H	96
430302H	68	430364H	68	430425	70	430506H	72	430669	255	430766H	96
430303H	68	430365H	68	430426	70	430507H	72	430670	255	430767H	96
430304-N	125	430366H	68	430427	70	430508H	72	430671	255	430768H	96
430304H	68	430367H	68	430428H	70	430509H	72	430672	255	430769H	96
430304H-N	125	430368H	68	430429H	70	430510H	72	430673	255	430770H	96
430304H-N	74	430369H	68	430430H	70	430511H	72	430674	255	430771H	96
430304H-R	74, 125	430370H	68	430431H	70	430512H	72	430675	255	430772H	96
430305H	68	430371H	68	430432H	70	430513H	72	430676	255	430773H	96
430306H	68	430372H	68	430433H	70	430514H	72	430677	255	430774H	96
430307H	68	430373H	68	430434H	70	430515H	72	430678	255	430775H	96
430308H	68	430374H	68	430435H	70	430516H	73	430679	255	430776H	96
430309H	68	430375H	68	430436H	70	430517H	73	430680	255	430777H	96
430310H	68	430380H	69	430437H	70	430518H	73	430681	255	430778H	96
430311H	68	430381H	69	430438H	70	430519H	73	430684	298	430779H	97
430312-N	125	430382H	69	430439H	70	430520H	73	430685	497	430780H	97
430312H	68	430383H	69	430440H	70	430521H	73	430686	497	430781H	97
430312H-N	74, 125	430384H	69	430441H	70	430522H	73	430687	497	430782H	97
430312H-R	74, 125	430385H	69	430442H	70	430523H	73	430688	497	430783H	97
430313H	68	430386H	69	430443H	70	430524H	73	430689	497	430784H	97
430314H	68	430387H	69	430444H	70	430525H	73	430690	497	430785H	97
430315H	68	430388H	69	430445H	70	430526H	73	430691	497	430786H	97
430316H	68	430389H	69	430446H	70	430527H	73	430692	497	430787H	97
430317H	68	430390H	69	430447H	70	430528H	73	430693	497	430788H	97
430318H	68	430391H	69	430448H	70	430529H	73	430694	497	430789H	97
430319H	68	430392H	69	430449H	70	430530H	73	430701H	93	430790H	97
430320H	68	430393H	69	430450H	70	430531H	73	430702H	93	430791H	97
430321H	68	430394H	69	430451H	70	430532H	73	430703H	93	430792H	97
430322H	68	430395H	69	430452H	70	430533H	73	430704H	93	430793H	97
430323H	68	430396H	69	430453H	70	430534H	73	430705H	93	430794H	97
430324H	68	430397H	69	430454H	70	430535H	73	430706H	93	430795H	97
430325H	68	430398H	69	430455H	70	430536H	73	430707H	93	430796H	97
430326H	68	430398H-TF	72	430456H	70	430537H	73	430708H	93	430797H	85
430327H	68	430398H-TK	73	430457H	70	430538H	73	430709H	93	430798H	85
430328H	68	430399H	69	430458H	70	430539H	73	430710H	93	430802H	97
430329H	68	430399H-TF	72	430459H	70	430564H	70	430711H	93	430803H	97
430330H	68	430399H-TK	73	430460H	70	430565H	70	430712H	93	430804H	97
430331H	68	430400H	69	430461H	70	430566H	70	430713H	93	430805H	97
430332H	68	430400H-TF	72	430462H	70	430567H	70	430714H	93	430806H	98
430333H	68	430400H-TK	73	430463H	70	430568H	70	430715H	93	430807H	98
430334H	68	430401H	69	430464H	72	430569H	70	430716H	93	430808H	98
430335H	68	430401H-TF	72	430465H	72	430570H	70	430717H	95	430809H	98
430336H	68	430401H-TK	73	430466H	72	430571H	70	430718H	95	430810H	98
430337H	68	430402H	69	430467H	72	430572H	70	430719H	95	430811H	98
430338H	68	430402H-TF	72	430468H	72	430573H	70	430720H	95	430812H	98
430339H	68	430402H-TK	73	430469H	72	430574H	70	430721H	93	430813H	98
430340H	68	430403H	69	430470H	72	430575H	70	430722H	93	430814H	98
430340H-TK	73	430403H-TF	72	430471H	72	430599H	309	430723H	93	430815H	98
430341H	68	430403H-TK	73	430472H	72	430635	253	430724H	93	430816H	98
430341H-TK	73	430404H	69	430473H	72	430636	253	430725H	93	430817H	98
430342H	68	430404H-TF	72	430474H	72	430637	253	430726H	93	430818H	98
430342H-TK	73	430404H-TK	73	430475H	72	430638	253	430727H	93	430819H	98
430343H	68	430405H	69	430476H	72	430639	253	430728H	93	430820H	98
430343H-TK	73	430405H-TF	72	430476H-TF	72	430640	253	430729H	94	430821H	98
430344H	68	430405H-TK	73	430476H-TK	73	430641	253	430730H	94	430822H	98
430344H-TK	73	430406H	69	430477H	72	430642	253	430731H	94	430823H	98
430345H	68	430406H-TF	72	430480H	70	430643	253	430732H	94	430824H	98
430345H-TK	73	430406H-TK	73	430481H	70	430644	253	430733H	94	430825H	98
430346H	68	430407H	69	430482H	70	430645	254	430734H	94	430826H	99
430346H-TK	73	430407H-TF	72	430483H	70	430646	254	430735H	94	430827H	99
430347H	68	430407H-TK	73	430484H	70	430647	254	430736H	94	430828H	99
430347H-TK	73	430408H	69	430485H	70	430648	254	430737H	95	430829H	99
430348H	68	430408H-TF	72	430486H	70	430649	254	430738H	95	430834H	85
430348H-TK	73	430408H-TK	73	430487H	70	430650	254	430739H	95	430835H	85
430349H	68	430409H	69	430488H	70	430651	254	430740H	95	430836H	85
430349H-TK	73	430409H-TF	72	430489H	70	430652	254	430741H	95	430837H	85
430350H	68	430409H-TK	73	430490H	70	430653	254	430742H	95	430838H	85
430350H-TK	73	430410H	69	430491H	70	430654	254	430743H	95	430839H	85
430351H	68	430411H	69	430492H	70	430655	254	430744H	95	430840H	85
430351H-TK	73	430412H	69	430493H	70	430656	254	430753H	96	430841H	85
430352H	68	430413H	69	430494H	70	430657	254	430754H	96	430842H	85
430353H	68	430414H	69	430495H	70	430658	254	430755H	96	430843H	85
430354H	68	430415H	69	430496H	70	430659	254	430756H	96	430844H	85

Artikel-Nr.	Seite	Artikel-Nr.	Seite	Artikel-Nr.	Seite	Artikel-Nr.	Seite	Artikel-Nr.	Seite	Artikel-Nr.	Seite
430845H	85	430927	119	431116H	287	431489	45	431580H-TF	94	431679H	480
430846H	85	430928	119	431117H	287	431490	45	431581H	94	431680H	480
430847H	85	430929	119	431118H	287	431491	45	431581H-TF	94	431681H	480
430848H	85	430930	119	431119H	287	431492	45	431582H	94	431682H	480
430849H	85	430931	119	431120H	287	431493	45	431583H	94	431683H	480
430850H	85	430932	119	431121H	287	431494	45	431584H	94	431684H	480
430851H	85	430933	119	431122H	287	431495	45	431585H	94	431685H	480
430853	430	430934	119	431320	201	431496	45	431586H	94	431686H	480
430854	430	430935	119	431321	201	431497	45	431587H	94	431687H	481
430855	430	430936	119	431328H	272	431498	45	431601H	399	431688H	481
430856	430	430937	119	431329H	272	431499	45	431602H	399	431689H	481
430857	430	430938	119	431330H	272	431501H	93	431603H	399	431690H	481
430858	430	430939	119	431331H	272	431502H	93	431604H	399	431691H	481
430859	430	430940	119	431332H	272	431503H	93	431605H	399	431692H	299, 480
430860	430	430941	119	431333H	272	431504H	93	431606H	399	431693H	299, 480
430861	430	430942	119	431334H	272	431505H	93	431607H	399	431694H	299, 480
430862	430	430943	119	431335H	272	431506H	93	431608H	399	431695H	480
430863	430	430944	119	431336H	272	431507H	93	431609H	399	431696H	480
430864	430	430945	119	431337H	272	431508H	93	431610H	399	431697H	480
430865	430	430946	120	431338H	272	431509H	93	431611H	399	431715H	309
430866	430	430947	120	431339H	272	431510H	93	431612H	399	431716H	309
430867	430	430948	120	431340H	272	431511H	93	431613H	399	431717H	309
430868	430	430949	120	431341H	272	431512H	93	431614H	399	431718H	309
430869	430	430950	120	431342H	272	431513H	94	431615H	399	431719H	309
430870	430	430951	120	431343H	272	431514H	94	431616H	399	431720H	309
430871	430	430952	120	431344	272	431515H	94	431617H	399	431721H	309
430872	430	430953	120	431345	272	431516H	94	431618H	399	431722H	309
430873	430	430954	120	431346	272	431523H	95	431619H	399	431723H	309
430874	430	430955	120	431347	272	431524H	95	431620H	399	431727H	309
430875	430	430956	120	431348H	272	431525H	95	431621H	399	431736H	309
430876	430	430957	120	431349H	272	431526H	95	431622H	399	431744H	307
430877	430	430958	120	431350H	272	431527H	95	431623H	399	431745H	307
430878	430	430959	120	431351H	272	431528H	95	431624H	399	431746H	307
430879	430	430960	120	431352H	410	431529H	95	431630H	455	431747H	307
430880	430	430963	110	431353H	410	431530H	95	431631H	455	431748H	307
430881	431	430964	110	431354H	410	431531H	95	431632H	455	431749H	307
430882	431	430965	110	431355H	410	431532H	95	431633H	455	431750H	308
430883	431	430966	110	431356H	410	431533H	96	431634H	455	431751H	308
430884	431	430967	110	431357H	410	431534H	96	431635H	455	431752H	308
430885	431	430968	110	431358H	410	431535H	96	431636H	455	431753H	308
430886	431	430977	119, 298	431359H	410	431536H	96	431637H	455	431754H	308
430887	431	430978	119, 298	431363H	410	431537H	96	431638H	455	431755H	308
430888	431	430979	119, 298	431364H	410	431538H	96	431639H	455	431756H	309
430889	431	430984H	95	431365H	410	431539H	96	431640H	455	431757H	309
430890	431	430985H	95	431366H	410	431540H	96	431641H	455	431762H	309
430891	431	430986H	95	431367H	410	431541H	96	431642H	455	431763H	309
430892	431	430987H	95	431368H	410	431542H	96	431643H	455	431765H	309
430893	431	430988H	95	431369H	410	431543H	96	431644H	455	431785H	309
430894	431	430989H	95	431370H	410	431544H	96	431645H	455	431786H	309
430895	431	430990H	95	431371H	410	431545H	96	431647H	480	431787H	309
430896	431	430991H	95	431372H	410	431546H	97	431648H	480	431794H	309
430897	431	430993	118, 298	431373H	410	431547H	97	431649H	480	431797H	309
430898	431	430995	119, 298	431374H	410	431548H	97	431650H	480	431801H	307
430899	431	430996	119, 298	431380	404	431549H	97	431651H	480	431802H	307
430900	431	430997	119, 298	431381	404	431550H	97	431652H	480	431803H	307
430901	118	431006	110	431382	404	431551H	97	431653H	480	431804H	307
430902	118	431007	110	431383	404	431552H	97	431654H	480	431805H	307
430903	118	431008	110	431384	404	431553H	97	431655H	480	431806H	307
430904	118	431009	110	431385	404	431554H	97	431656H	480	431807H	307
430905	118	431020	430	431386	404	431555H	97	431657H	480	431808H	307
430906	118	431021	430	431387	404	431556H	97	431658H	480	431809H	307
430907	118	431022	430	431388	404	431557H	98	431659H	480	431810H	307
430908	118	431023	430	431389	404	431558H	98	431660H	480	431811H	307
430909	118	431024	430	431390	404	431559H	98	431661H	480	431817H	307
430910	118	431025	430	431391	404	431560H	98	431662H	480	431818H	307
430911	118	431026	430	431392	404	431561H	98	431663H	480	431819H	307
430912	118	431027	431	431393	404	431562H	98	431664H	480	431820H	307
430913	118	431028	431	431394	404	431563H	98	431665H	480	431821H	307
430914	118	431029	431	431395H	410	431564H	98	431666H	480	431822H	307
430915	118	431030	431	431396H	410	431565H	98	431667H	480	431823H	307
430916	118	431031	431	431397H	410	431566H	98	431668H	480	431824H	307
430917	118	431045	118	431398H	410	431567H	99	431669H	480	431825H	307
430918	118	431046	118	431480	45	431576H	94	431670H	481	431826H	307
430919	118	431047	118	431481	45	431576H-TF	94	431671H	481	431827H	307
430920	118	431048	118	431482	45	431577H	94	431672H	481	431828H	307
430921	118	431049	118	431483	45	431577H-TF	94	431673H	481	431829H	308
430922	118	431111H	287	431484	45	431578H	94	431674H	481	431830H	308
430923	118	431112H	287	431485	45	431578H-TF	94	431675	481	431831H	308
430924	118	431113H	287	431486	45	431579H	94	431676	481	431832H	308
430925	118	431114H	287	431487	45	431579H-TF	94	431677H	480	431833H	308
430926	119	431115H	287	431488	45	431580H	94	431678H	480	431834H	308

Artikel-Nr.	Seite	Artikel-Nr.	Seite	Artikel-Nr.	Seite	Artikel-Nr.	Seite	Artikel-Nr.	Seite	Artikel-Nr.	Seite
431835H	308	433408	194	433855	194	435317H	466	435455H-TF	464	435603H	75
431836H	308	433410	194	433856	194	435318H	466	435455H-TK	465	435604H	75
431837H	308	433411	194	433891	486	435319H	466	435456H	464	435605H	75
431838H	308	433412	194	434194	298	435320H	466	435456H-TF	464	435606H	75
431839H	308	433430	194	434216	200	435321H	466	435456H-TK	465	435607H	75
431840H	308	433432	194	434217	200	435322H	466	435457H	464	435608H	75
431841H	308	433434	194	434218	200	435323H	466	435457H-TF	464	435609H	75
431842H	308	433436	194	434219	200	435324H	466	435457H-TK	465	435610H	75
431843H	308	433438	194	434220	200	435372H	463	435458H	464	435611H	75
431844H	308	433440	194	434221	200	435373H	463	435458H-TF	464	435612H	75
431845H	308	433442	194	434222	200	435374H	463	435458H-TK	465	435613H	75
431846H	308	433660	194	434223	200	435375H	463	435459H	464	435614H	75
431847H	308	433661	194	434224	200	435376H	463	435459H-TF	464	435615H	75
431848H	308	433662	194	434225	200	435377H	463	435459H-TK	465	435616H	75
431849H	308	433664	194	434226	200	435378H	463	435460H	464	435617H	75
431850H	308	433665	194	434227	200	435379H	463	435461H	464	435618H	75
431851H	308	433666	194	434228	200	435380H	463	435462H	464	435619H	75
431852H	309	433671	486	434229	200	435381H	463	435463H	464	435620H	75
431853H	309	433672	486	434230	200	435382H	463	435464H	464	435621H	75
431854H	309	433673	486	434231	200	435383H	463	435465H	464	435622H	75
431855H	309	433674	486	434232	200	435384H	463	435466H	464	435623H	75
431856H	309	433678	487	434233	200	435385H	463	435467H	464	435624H	75
431857H	309	433679	487	434234	200	435386H	463	435468H	464	435625H	75
431864H	309	433680	487	434235	200	435387H	463	435468H-TF	464	435626H	75
431865H	309	433681	487	434236	200	435397H	463	435468H-TK	465	435627H	75
431866H	309	433685	487	434237	200	435398H	463	435469H	464	435628H	75
431867H	309	433686	487	434238	200	435399H	463	435469H-TF	464	435629H	75
431868H	309	433687	487	434239	200	435400H	463	435469H-TK	465	435630H	75
431869H	309	433688	487	434240	200	435401H	463	435470H	464	435631H	75
431873H	307	433692	139	434241	200	435402H	463	435470H-TF	464	435632H	75
431874H	307	433693	139	434248	201	435403H	463	435470H-TK	465	435633H	75
431875H	307	433694	139	434249	201	435404H	463	435471H	464	435634H	75
431876H	307	433695	139	434250	201	435409H	463	435471H-TF	464	435635H	75
431877H	307	433696	139	434251	201	435410H	463	435471H-TK	465	435636H	75
431887H	309	433697	139	434252	201	435411H	463	435472H	464	435637H	75
431893H	309	433701	487	434253	201	435412H	463	435472H-TF	464	435638H	75
431894H	309	433702	487	434256	200	435413H	463	435472H-TK	465	435639H	75
431913	207	433703	487	434328	200	435414H	463	435473H	464	435640H	75
431914	207	433704	487	434330	200	435415H	463	435473H-TF	464	435641H	75
431915	207	433730	194	434332	200	435416H	463	435473H-TK	465	435642H	75
431919H	207	433731	194	434334	200	435417H	463	435474H	464	435643H	75
431920	207	433732	194	434336	200	435418H	463	435474H-TF	464	435644H	75
431921	207	433733	194	434342	201	435419H	463	435474H-TK	465	435645H	75
431922	207	433734	194	434344	201	435420H	463	435475H	464	435646H	75
431965H	480	433735	194	434432	487	435421H	463	435475H-TF	464	435647H	75
431966H	480	433756	139	434433	487	435422H	463	435475H-TK	465	435648H	75
431967H	480	433757	139	434434	487	435423H	463	435476H	464	435649H	75
432027	201	433758	139	434435	487	435424H	463	435477H	464	435650H	75
432028	201	433770	486	434976	200	435428H	463	435478H	464	435651H	75
432029	201	433771	486	434977	200	435428H-TK	465	435479H	464	435652H	75
432030	201	433772	486	434978	200	435429H	463	435480H	464	435653H	75
432033	201	433773	486	434979	200	435429H-TK	465	435481H	464	435654H	75
432034	201	433778	486	434980	201	435430H	463, 465	435482H	464	435655H	75
432035	201	433779	486	434981	201	435431H	463	435483H	464	435656H	75
432036	201	433780	486	434983H	45	435431H-TK	465	435484H	465	435657H	75
432039	201	433781	486	434984H	45	435432H	463	435485H	465	435658H	75
432040	201	433786	486	434985H	45	435432H-TK	465	435486H	465	435659H	75
432041	201	433787	486	434986H	455	435433H	463	435487H	465	435660H	75
432042	201	433789	486	434987H	455	435433H-TK	465	435488H	465	435661H	75
432045	201	433793	486	434988H	455	435434H	463	435489H	465	435662H	75
432046	201	433794	486	434989H	455	435434H-TK	465	435490H	465	435663H	75
432047	201	433795	486	435026	200	435435H	463	435491H	465	435664H	75
432048	201	433796	486	435027	200	435435H-TK	465	435492H	466	435665H	75
432292	298	433802	194	435028	200	435436H	464	435493H	466	435666H	75
432293	298	433803	194	435029	200	435437H	464	435494H	466	435667H	75
432294	298	433804	194	435301H	463	435438H	464	435495H	466	435668H	75
432323	455	433806	194	435302H	463	435439H	464	435496H	466	435669H	75
432324	455	433807	194	435303H	463	435440H	464	435497H	466	435670H	75
432325	455	433808	194	435304H	463	435441H	464	435498H	466	435671H	75
432326	455	433817	194	435305H	463	435442H	464	435499H	466	435672H	75
432335H	454	433819	194	435306H	463	435443H	464	435569H	66	435673H	75
432336H	454	433821	194	435307H	463	435452H	464	435570H	67	435674H	75
432337H	454	433823	194	435308H	463	435452H-TF	464	435571H	67	435675H	75
432338H	454	433841	486	435309H	466	435452H-TK	465	435572H	67	435676H	75
432805-HKS	194	433842	486	435310H	466	435453H	464	435573H	67	435677H	75
432805-IE	194	433843	486	435311H	466	435453H-TF	464	435574H	67	435678H	75
433402	194	433844	486	435312H	466	435453H-TK	465	435575H	67	435679H	75
433403	194	433850	194	435313H	466	435454H	464	435576H	69	435680H	75
433404	194	433851	194	435314H	466	435454H-TF	464	435577H	69	435681H	75
433406	194	433852	194	435315H	466	435454H-TK	465	435601H	75	435682H	75
433407	194	433854	194	435316H	466	435455H	464	435602H	75	435683H	75

Artikel-Nr.	Seite	Artikel-Nr.	Seite	Artikel-Nr.	Seite	Artikel-Nr.	Seite	Artikel-Nr.	Seite	Artikel-Nr.	Seite
435684H	75	435949H	443	436132H	421	436235H	320	538021-400	107	552007-341550HK	351
435685H	72	435950H	443	436133H	421	436236H	320	538260-400	107	552007-342550HK	352
435685H-TF	72	435951H	443	436134H	421	436237H	320	538261-400	107	552007-352010HK	351
435685H-TK	73	435952H	443	436135H	421	436238H	320	538280-400	107	552007-352050HK	352
435686H	72	435953H	443	436136H	421	436239H	320	538281-400	107	552007-41550HK	146
435686H-TF	72	435954H	443	436137H	421	436240H	320	552001-12020H	146	552007-42550HK	146
435686H-TK	73	435955H	443	436138H	421	436241H	320	552001-12023H	147	552008-12020H	146
435687H	72	435956H	443	436139H	421	436242H	320	552001-12050H	146	552008-12050H	146
435687H-TF	72	435957H	443	436140H	421	436243H	320	552001-12053H	147	552008-18120H	146
435687H-TK	73	435958H	443	436141H	421	44400H	332	552001-18120H	146	552008-18210H	146
435688H	72	435959H	443	436142H	421	44401H	332	552001-18123H	147	552008-341550HK	351
435688H-TF	72	435960H	443	436143H	421	44425H	332	552001-18124H	147	552008-342550HK	352
435688H-TK	73	435961H	443	436144H	422	44447H	332	552001-18210H	146	552008-352010HK	351
435689H	72	435962H	443	436145H	422	44448H	332	552001-18213H	147	552008-352050HK	352
435689H-TF	72	435963H	443	436146H	422	44449H	332	552001-18214H	147	552008-41550HK	146
435689H-TK	73	435964H	443	436147H	422	44500H	332	552001-341550HK	351	552008-42550HK	146
435690H	72	435965H	443	436148H	422	44501H	332	552001-342550HK	352	552009-12020H	146
435690H-TF	72	435966H	443	436149H	422	45550H	185	552001-352010HK	351	552009-12050H	146
435690H-TK	73	435967H	443	436150H	422	45551H	185	552001-352050HK	352	552009-18120H	146
435691H	72	435968H	443	436151H	422	45552H	185	552001-41550HK	146	552009-18210H	146
435691H-TF	72	435969H	443	436152H	422	45553H	185	552001-42550HK	146	552009-341550HK	351
435691H-TK	73	435970H	443	436153H	422	45554H	185	552002-12020H	146	552009-342550HK	352
435692H	72	435971H	443	436154H	422	45555H	185	552002-12023H	147	552009-352010HK	351
435692H-TF	72	435972H	444	436155H	422	45556H	185	552002-12050H	146	552009-352050HK	352
435692H-TK	73	435973H	444	436156H	420	45557H	185	552002-12053H	147	552009-41550HK	146
435693H	72	435974H	444	436157H	420	45600H	185	552002-18120H	146	552009-42550HK	146
435693H-TF	72	435975H	444	436158H	420	45601H	185	552002-18123H	147	552010-12020H	146
435693H-TK	73	435976H	444	436159H	420	45602H	185	552002-18124H	147	552010-12050H	146
435694H	72	435977H	444	436160H	420	45603H	185	552002-18210H	146	552010-18120H	146
435694H-TF	72	435978H	444	436161H	420	45604H	185	552002-18213H	147	552010-18210H	146
435694H-TK	73	435979H	444	436162H	420	45605H	185	552002-18214H	147	552010-341550HK	351
435695H	72	435980H	444	436163H	420	45606H	185	552002-341550HK	351	552010-342550HK	352
435696H	72	435981H	444	436164H	420	45607H	185	552002-342550HK	352	552010-352010HK	351
435697H	72	435982H	444	436165H	420	47050H	241	552002-352010HK	351	552010-352050HK	352
435698H	72	435983H	444	436166H	420	47051H	241	552002-352050HK	352	552010-41550HK	146
435699H	72	435984H	444	436167H	420	47052H	241	552002-41550HK	146	552010-42550HK	146
435700H	72	435985H	444	436168H	421	47053H	241	552002-42550HK	146	552011-12020H	146
435701H	72	435986H	444	436169H	421	47054H	241	552003-12020H	146	552011-12050H	146
435702H	72	435987H	444	436170H	421	47075H	241	552003-12050H	146	552011-18120H	146
435703H	72	435988H	444	436171H	421	47076H	241	552003-18120H	146	552011-18210H	146
435704H	72	435989H	444	436172H	421	47077H	241	552003-18210H	146	552011-341550HK	351
435901H	215	435990H	444	436173H	421	47078H	241	552003-341550HK	351	552011-342550HK	352
435902H	215	435991H	444	436174H	421	47079H	241	552003-342550HK	352	552011-352010HK	351
435903H	215	435992H	444	436175H	421	47250H	241	552003-352010HK	351	552011-352050HK	352
435904H	215	435993H	444	436176H	421	47251H	241	552003-352050HK	352	552011-41550HK	146
435905H	215	435994H	444	436177H	421	47252H	241	552003-41550HK	146	552011-42550HK	146
435906H	215	435995H	444	436178H	421	47253H	241	552003-42550HK	146	552012-12020H	146
435907H	215	435996H	444	436179H	421	47254H	241	552004-12020H	146	552012-12050H	146
435908H	215	435997H	444	436180H	422	47255H	241	552004-12050H	146	552012-18120H	146
435909H	215	435998H	444	436181H	422	47256H	241	552004-18120H	146	552012-18210H	146
435910H	215	435999H	444	436182H	422	47257H	241	552004-18210H	146	552012-341550HK	351
435911H	215	436100	112	436183H	422	47258H	241	552004-341550HK	351	552012-342550HK	352
435912H	215	436101	112	436184H	422	47259H	241	552004-342550HK	352	552012-352010HK	351
435913H	215	436102	112	436185H	422	47275H	241	552004-352010HK	351	552012-352050HK	352
435914H	215	436103	112	436186H	422	47276H	241	552004-352050HK	352	552012-41550HK	146
435915H	215	436104	112	436187H	422	47277H	241	552004-41550HK	146	552012-42550HK	146
435916H	215	436105	112	436188H	422	47278H	241	552004-42550HK	146	552013-12020H	148
435917H	215	436106	112	436189H	422	47279H	241	552005-12020H	146	552013-12050H	148
435918H	215	436107	112	436190H	422	47280H	241	552005-12050H	146	552013-18120H	148
435919H	215	436110H	420	436191H	422	47281H	241	552005-18120H	146	552013-18210H	148
435920H	215	436111H	420	436192H	422	47282H	241	552005-18210H	146	552013-341550HK	351
435921H	215	436112H	420	436193H	422	47283H	241	552005-341550HK	351	552013-342550HK	352
435922H	215	436113H	420	436194H	422	47284H	241	552005-342550HK	352	552013-352010HK	351
435923H	215	436114H	420	436195H	422	47650H	241	552005-352010HK	351	552013-352050HK	352
435924H	215	436115H	420	436196H	422	47651H	241	552005-352050HK	352	552013-41550HK	148
435925H	215	436116H	420	436197H	422	47652H	241	552005-41550HK	146	552013-42550HK	148
435926H	216	436117H	420	436220H	320	47653H	241	552005-42550HK	146	552014-12020H	148
435927H	216	436118H	420	436221H	320	47654H	241	552006-12020H	146	552014-12050H	148
435928H	216	436119H	420	436222H	320	47655H	241	552006-12050H	146	552014-18120H	148
435929H	216	436120H	420	436223H	320	47656H	241	552006-18120H	146	552014-18210H	148
435930H	216	436121H	420	436224H	320	47657H	241	552006-18210H	146	552014-341550HK	351
435931H	216	436122H	420	436225H	320	47658H	241	552006-341550HK	351	552014-342550HK	352
435932H	216	436123H	420	436226H	320	47659H	241	552006-342550HK	352	552014-352010HK	351
435933H	216	436124H	420	436227H	320	509-18120	113	552006-352010HK	351	552014-352050HK	352
435934H	216	436125H	420	436228H	320	531910-148	107	552006-352050HK	352	552014-41550HK	148
435935H	216	436126H	420	436229H	320	531911-148	107	552006-41550HK	146	552014-42550HK	148
435936H	216	436127H	420	436230H	320	532212-800	107	552006-42550HK	146	552015-12020H	148
435937H	216	436128H	421	436231H	320	532230-800	107	552007-12020H	146	552015-12050H	148
435938H	216	436129H	421	436232H	320	533434-198	108	552007-12050H	146	552015-18120H	148
435939H	216	436130H	421	436233H	320	533436-198	108	552007-18120H	146	552015-18210H	148
435948H	443	436131H	421	436234H	320	538020-400	107	552007-18210H	146	552015-341550HK	351

Artikel-Nr.	Seite	Artikel-Nr.	Seite	Artikel-Nr.	Seite	Artikel-Nr.	Seite	Artikel-Nr.	Seite	Artikel-Nr.	Seite
552015-342550HK	352	552023-352010HK	353	552031-352050HK	354	552039-41550HK	149	553001-38117H	155	553039-38110H	154
552015-352010HK	351	552023-352050HK	354	552031-41550HK	148	552039-42550HK	149	553001-38118H	155	553040-32020H	154
552015-352050HK	352	552023-41550HK	148	552031-42550HK	148	552040-12020H	149	553002-32020H	153	553040-32050H	154
552015-41550HK	148	552023-42550HK	148	552032-12020H	148	552040-12050H	149	553002-32025H	155	553040-38110H	154
552015-42550HK	148	552024-12020H	148	552032-12050H	148	552040-18120H	149	553002-32027H	155	553112-32020H	154
552016-12020H	148	552024-12050H	148	552032-18120H	148	552040-18210H	149	553002-32050H	153	553112-32050H	154
552016-12050H	148	552024-18120H	148	552032-18210H	148	552040-341550HK	353	553002-32055H	155	553112-38110H	154
552016-18120H	148	552024-18210H	148	552032-341550HK	353	552040-342550HK	354	553002-32057H	155	553113-32020H	154
552016-18210H	148	552024-341550HK	353	552032-342550HK	354	552040-352010HK	353	553002-38110H	153	553113-32050H	154
552016-341550HK	351	552024-342550HK	354	552032-352010HK	353	552040-352050HK	354	553002-38115H	155	553113-38110H	154
552016-342550HK	352	552024-352010HK	353	552032-352050HK	354	552040-41550HK	149	553002-38116H	155	553115-32020H	154
552016-352010HK	351	552024-352050HK	354	552032-41550HK	148	552040-42550HK	149	553002-38117H	155	553115-32050H	154
552016-352050HK	352	552024-41550HK	148	552032-42550HK	148	552112-12020H	146	553002-38118H	155	553115-38110H	154
552016-41550HK	148	552024-42550HK	148	552033-12020H	149	552112-12050H	146	553003-32020H	153	553117-32020H	154
552016-42550HK	148	552025-12020H	148	552033-12050H	149	552112-18120H	146	553003-32050H	153	553117-32050H	154
552017-12020H	148	552025-12050H	148	552033-18120H	149	552112-18210H	146	553003-38110H	153	553117-38110H	154
552017-12050H	148	552025-18120H	148	552033-18210H	149	552112-341550HK	351	553004-32020H	153	553118-32020H	154
552017-18120H	148	552025-18210H	148	552033-341550HK	353	552112-342550HK	352	553004-32050H	153	553118-32050H	154
552017-18210H	148	552025-341550HK	353	552033-342550HK	354	552112-352010HK	351	553004-38110H	153	553118-38110H	154
552017-341550HK	353	552025-342550HK	354	552033-352010HK	353	552112-352050HK	352	553006-32020H	153	553119-32020H	154
552017-342550HK	354	552025-352010HK	353	552033-352050HK	354	552112-41550HK	146	553006-32050H	153	553119-32050H	154
552017-352010HK	353	552025-352050HK	354	552033-41550HK	149	552112-42550HK	146	553006-38110H	153	553119-38110H	154
552017-352050HK	354	552025-41550HK	148	552033-42550HK	149	552113-12020H	146	553007-32020H	153	554001-32020H	157
552017-41550HK	148	552025-42550HK	148	552034-12020H	149	552113-12050H	146	553007-32050H	153	554001-32025H	158
552017-42550HK	148	552026-12020H	148	552034-12050H	149	552113-18120H	146	553007-38110H	153	554001-32027H	158
552018-12020H	148	552026-12050H	148	552034-18120H	149	552113-18210H	146	553008-32020H	153	554001-32050H	158
552018-12050H	148	552026-18120H	148	552034-18210H	149	552113-341550HK	351	553008-32050H	153	554001-32055H	158
552018-18120H	148	552026-18210H	148	552034-341550HK	353	552113-342550HK	352	553008-38110H	153	554001-32057H	158
552018-18210H	148	552026-341550HK	353	552034-342550HK	354	552113-352010HK	351	553010-32020H	153	554001-38110H	157
552018-341550HK	353	552026-342550HK	354	552034-352010HK	353	552113-352050HK	352	553010-32050H	153	554001-38115H	158
552018-342550HK	354	552026-352010HK	353	552034-352050HK	354	552113-41550HK	146	553010-38110H	153	554001-38116H	158
552018-352010HK	353	552026-352050HK	354	552034-41550HK	149	552113-42550HK	146	553011-32020H	153	554001-38117H	158
552018-352050HK	354	552026-41550HK	148	552034-42550HK	149	552115-12020H	146	553011-32050H	153	554001-38118H	158
552018-41550HK	148	552026-42550HK	148	552035-12020H	149	552115-12050H	146	553011-38110H	153	554002-32020H	157
552018-42550HK	148	552027-12020H	148	552035-12050H	149	552115-18120H	146	553014-32020H	153	554002-32025H	158
552019-12020H	148	552027-12050H	148	552035-18120H	149	552115-18210H	146	553014-32050H	153	554002-32027H	158
552019-12050H	148	552027-18120H	148	552035-18210H	149	552115-341550HK	351	553014-38110H	153	554002-32050H	157
552019-18120H	148	552027-18210H	148	552035-341550HK	353	552115-342550HK	352	553015-32020H	153	554002-32055H	158
552019-18210H	148	552027-341550HK	353	552035-342550HK	354	552115-352010HK	351	553015-32050H	153	554002-32057H	158
552019-341550HK	353	552027-342550HK	354	552035-352010HK	353	552115-352050HK	352	553015-38110H	153	554002-38110H	157
552019-342550HK	354	552027-352010HK	353	552035-352050HK	354	552115-41550HK	146	553016-32020H	153	554002-38115H	158
552019-352010HK	353	552027-352050HK	354	552035-41550HK	149	552115-42550HK	146	553016-32050H	153	554002-38116H	158
552019-352050HK	354	552027-41550HK	148	552035-42550HK	149	552117-12020H	146	553016-38110H	153	554002-38117H	158
552019-41550HK	148	552027-42550HK	148	552036-12020H	149	552117-12050H	146	553018-32020H	153	554002-38118H	158
552019-42550HK	148	552028-12020H	148	552036-12050H	149	552117-18120H	146	553018-32050H	153	554003-32020H	157
552020-12020H	148	552028-12050H	148	552036-18120H	149	552117-18210H	146	553018-38110H	153	554003-32050H	157
552020-12050H	148	552028-18120H	148	552036-18210H	149	552117-341550HK	351	553019-32020H	153	554003-38110H	157
552020-18120H	148	552028-18210H	148	552036-341550HK	353	552117-342550HK	352	553019-32050H	153	554004-32020H	157
552020-18210H	148	552028-341550HK	353	552036-342550HK	354	552117-352010HK	351	553019-38110H	153	554004-32050H	157
552020-341550HK	353	552028-342550HK	354	552036-352010HK	353	552117-352050HK	352	553023-32020H	153	554004-38110H	157
552020-342550HK	354	552028-352010HK	353	552036-352050HK	354	552117-41550HK	146	553023-32050H	153	554006-32020H	157
552020-352010HK	353	552028-352050HK	354	552036-41550HK	149	552117-42550HK	146	553023-38110H	153	554006-32050H	157
552020-352050HK	354	552028-41550HK	148	552036-42550HK	149	552118-12020H	146	553026-32020H	153	554006-38110H	157
552020-41550HK	148	552028-42550HK	148	552037-12020H	149	552118-12050H	146	553026-32050H	153	554007-32020H	157
552020-42550HK	148	552029-12020H	148	552037-12050H	149	552118-18120H	146	553026-38110H	153	554007-32050H	157
552021-12020H	148	552029-12050H	148	552037-18120H	149	552118-18210H	146	553027-32020H	153	554007-38110H	157
552021-12050H	148	552029-18120H	148	552037-18210H	149	552118-341550HK	351	553027-32050H	153	554008-32020H	157
552021-18120H	148	552029-18210H	148	552037-341550HK	353	552118-342550HK	352	553027-38110H	153	554008-32050H	157
552021-18210H	148	552029-341550HK	353	552037-342550HK	354	552118-352010HK	351	553031-32020H	153	554008-38110H	157
552021-341550HK	353	552029-342550HK	354	552037-352010HK	353	552118-352050HK	352	553031-32050H	153	554010-32020H	157
552021-342550HK	354	552029-352010HK	353	552037-352050HK	354	552118-41550HK	146	553031-38110H	153	554010-32050H	157
552021-352010HK	353	552029-352050HK	354	552037-41550HK	149	552118-42550HK	146	553033-32020H	153	554010-38110H	157
552021-352050HK	354	552029-41550HK	148	552037-42550HK	149	552119-12020H	146	553033-32050H	153	554011-32020H	157
552021-41550HK	148	552029-42550HK	148	552038-12020H	149	552119-12050H	146	553033-38110H	153	554011-32050H	157
552021-42550HK	148	552030-12020H	148	552038-12050H	149	552119-18120H	146	553034-32020H	153	554011-38110H	157
552022-12020H	148	552030-12050H	148	552038-18120H	149	552119-18210H	146	553034-32050H	153	554014-32020H	157
552022-12050H	148	552030-18120H	148	552038-18210H	149	552119-341550HK	351	553034-38110H	153	554014-32050H	157
552022-18120H	148	552030-18210H	148	552038-341550HK	353	552119-342550HK	352	553035-32020H	153	554014-38110H	157
552022-18210H	148	552030-341550HK	353	552038-342550HK	354	552119-352010HK	351	553035-32050H	153	554015-32020H	157
552022-341550HK	353	552030-342550HK	354	552038-352010HK	353	552119-352050HK	352	553035-38110H	153	554015-32050H	157
552022-342550HK	354	552030-352010HK	353	552038-352050HK	354	552119-41550HK	146	553036-32020H	153	554015-38110H	157
552022-352010HK	353	552030-352050HK	354	552038-41550HK	149	552119-42550HK	146	553036-32050H	153	554016-32020H	157
552022-352050HK	354	552030-41550HK	148	552038-42550HK	149	553001-32020H	153	553036-38110H	153	554016-32050H	157
552022-41550HK	148	552030-42550HK	148	552039-12020H	149	553001-32025H	155	553037-32020H	154	554016-38110H	157
552022-42550HK	148	552031-12020H	148	552039-12050H	149	553001-32027H	155	553037-32050H	154	554019-32020H	157
552023-12020H	148	552031-12050H	148	552039-18120H	149	553001-32050H	153				

Artikel-Nr.	Seite	Artikel-Nr.	Seite	Artikel-Nr.	Seite	Artikel-Nr.	Seite	Artikel-Nr.	Seite	Artikel-Nr.	Seite
554026-32050H	157	555038-27182H	166	590-37040-21	189	620290-072	111	702-2019H	353	705-2004H	351
554026-38110H	157	555038-32020H	164	590-37042-21	189	620290-073	111	702-2020H	353	705-2005H	351
554027-32020H	157	555038-32050H	164	590-37043-21	189	620290-075	111	702-2022H	353	705-2006H	351
554027-32050H	157	555038-32080H	165	590-37044-21	189	620296-070	111	702-2023H	353	705-2007H	351
554027-38110H	157	555038-32100H	165	600334-070	112	620296-072	111	702-2024H	353	705-2008H	351
554031-32020H	157	555038-34090H	165	600334-072	112	620296-075	111	702-2026H	353	705-2009H	351
554031-32050H	157	555038-38110H	164	600334-073	112	620450-070	111	702-2027H	353	705-2010H	351
554031-38110H	157	555038-42550HK	164	600334-075	112	620450-072	111	702-2028H	353	705-2011H	351
554035-32020H	157	555038-42580HK	165	600355-103-70	125	620450-073	111	702-2030H	353	705-2012H	351
554035-32050H	157	555039-27180H	166	600355-106-70	125	620450-075	111	702-2031H	353	705-2013H	351
554035-38110H	157	555039-27181H	166	600356-103-70	125	620460-070	111	702-2032H	353	705-2014H	351
554036-32020H	157	555039-27182H	166	600356-106-70	125	620460-072	111	702-2034H	353	705-2015H	351
554036-32050H	157	555039-32020H	164	600357-103-70	125	620460-073	111	702-2035H	353	705-2016H	351
554036-38110H	157	555039-32050H	164	600357-106-70	125	620460-075	111	702-2036H	353	705-2017H	353
554038-32020H	157	555039-32080H	165	600384-070	112	620470-070	111	702-2038H	353	705-2018H	353
554038-32050H	157	555039-32100H	165	600384-072	112	620470-072	111	702-2039H	353	705-2019H	353
554038-38110H	157	555039-34090H	165	600384-073	112	620470-073	111	702-2040H	353	705-2020H	353
554039-32020H	157	555039-38110H	164	600384-075	112	620470-075	111	702-2111H	351	705-2021H	353
554039-32050H	157	555039-42550HK	164	600416-070	112	620480-072	111	702-2112H	351	705-2022H	353
554039-38110H	157	555039-42580HK	165	600416-072	112	620480-075	111	702-2113H	351	705-2023H	353
554040-32020H	157	555040-27180H	166	600416-073	112	620490-072	111	702-2114H	351	705-2024H	353
554040-32050H	157	555040-27181H	166	600416-075	112	620490-075	111	702-2115H	351	705-2025H	353
554040-38110H	157	555040-27182H	166	600417-070	112	620510-070	111	702-2116H	351	705-2026H	353
554111-32020H	157	555040-32020H	164	600417-072	112	620510-072	111	702-2117H	351	705-2027H	353
554111-32025H	158	555040-32050H	164	600417-073	112	620510-073	111	702-2118H	351	705-2028H	353
554111-32027H	158	555040-32080H	165	600417-075	112	620510-075	111	702-2119H	351	705-2029H	353
554111-32050H	157	555040-32100H	165	600420-070	112	620805-504	110	702-2120H	351	705-2030H	353
554111-32055H	158	555040-34090H	165	600420-072	112	620805-505	110	703-18120	113	705-2031H	353
554111-32057H	158	555040-38110H	164	600420-073	112	620806-504	110	703-2001H	351	705-2032H	353
554111-38110H	157	555040-42550HK	164	600420-075	112	620806-505	110	703-2002H	351	705-2033H	353
554111-38115H	158	555040-42580HK	165	600430-070-71	112	620811-504	110	703-2003H	351	705-2034H	353
554111-38116H	158	555113-27180H	166	600430-072-71	112	620811-505	110	703-2004H	351	705-2035H	353
554111-38117H	158	555113-27181H	166	600430-075-71	112	700-18120	113	703-2005H	351	705-2036H	353
554111-38118H	158	555113-27182H	166	600442-070	112	700-38110	113	703-2006H	351	705-2037H	353
554113-32020H	157	555113-32020H	164	600442-072	112	700i-12020H	146	703-2007H	351	705-2038H	353
554113-32050H	157	555113-32050H	164	600442-073	112	700i-12023H	147	703-2008H	351	705-2039H	353
554113-38110H	157	555113-32080H	165	600442-075	112	700i-12050H	146	703-2009H	351	705-2040H	353
554117-32020H	157	555113-32100H	165	600443-070	112	700i-12053H	147	703-2010H	351	705-2111H	351
554117-32050H	157	555113-34090H	165	600443-072	112	700i-18120H	146	703-2011H	351	705-2112H	351
554117-38110H	157	555113-38110H	164	600443-073	112	700i-18123H	147	703-2012H	351	705-2113H	351
554118-32020H	157	555113-42550HK	164	600443-075	112	700i-18124H	147	703-2013H	351	705-2114H	351
554118-32050H	157	555113-42580HK	165	600450-070	112	700i-18210H	146	703-2014H	351	705-2115H	351
554118-38110H	157	555117-27180H	166	600450-072	112	700i-18213H	147	703-2015H	351	705-2116H	351
554119-32020H	157	555117-27181H	166	600450-073	112	700i-18214H	147	703-2016H	351	705-2117H	351
554119-32050H	157	555117-27182H	166	600450-075	112	700i-341550HK	351	703-2017H	353	705-2118H	351
554119-38110H	157	555117-32020H	164	600499-070	112	700i-342550HK	352	703-2018H	353	705-2119H	351
555023-27180H	166	555117-32050H	164	600499-072	112	700i-352010HK	351	703-2019H	353	705-2120H	351
555023-27181H	166	555117-32080H	165	600499-073	112	700i-352050HK	352	703-2020H	353	705-2121H	351
555023-27182H	166	555117-32100H	165	600499-075	112	700i-41550HK	146	703-2021H	353	710-2001H	351
555023-32020H	164	555117-34090H	165	600859-504	110	700i-42550HK	146	703-2022H	353	710-2002H	351
555023-32050H	164	555117-38110H	164	600859-505	110	701-18120	113	703-2023H	353	710-2003H	351
555023-32080H	165	555117-42550HK	164	600864-504	110	701-38110	113	703-2024H	353	710-2004H	351
555023-32100H	165	555117-42580HK	165	600864-505	110	701i-12020H	146	703-2025H	353	710-2005H	351
555023-34090H	165	555118-27180H	166	601500-070-71	111	701i-12023H	147	703-2026H	353	710-2006H	351
555023-38110H	164	555118-27181H	166	601500-072-71	111	701i-12050H	146	703-2027H	353	710-2007H	351
555023-42550HK	164	555118-27182H	166	601500-075-71	111	701i-12053H	147	703-2028H	353	710-2008H	351
555023-42580HK	165	555118-32020H	164	601550-070-71	111	701i-18120H	146	703-2029H	353	710-2009H	351
555035-27180H	166	555118-32050H	164	601550-072-71	111	701i-18123H	147	703-2030H	353	710-2010H	351
555035-27181H	166	555118-32080H	165	601550-075-71	111	701i-18124H	147	703-2031H	353	710-2011H	351
555035-27182H	166	555118-32100H	165	610-2008	370	701i-18210H	146	703-2032H	353	710-2012H	351
555035-32020H	164	555118-34090H	165	610-2016	370	701i-18213H	147	703-2033H	353	710-2013H	351
555035-32050H	164	555118-38110H	164	610-2023	370	701i-18214H	147	703-2034H	353	710-2014H	351
555035-32080H	165	555118-42550HK	164	610-2033	370	701i-341550HK	351	703-2035H	353	710-2015H	351
555035-32100H	165	555118-42580HK	165	610-2038	370	701i-342550HK	352	703-2036H	353	710-2016H	351
555035-34090H	165	563-18120	113	610-2039	370	701i-352010HK	351	703-2037H	353	710-2017H	353
555035-38110H	164	5716-341550HK	351	610-2040	370	701i-352050HK	352	703-2038H	353	710-2018H	353
555035-42550HK	164	5716-342550HK	352	610-2041	370	701i-41550HK	146	703-2039H	353	710-2019H	353
555035-42580HK	165	5716-352010HK	351	610-2042	370	701i-42550HK	146	703-2040H	353	710-2020H	353
555036-27180H	166	5716-352050HK	352	610-2043	370	702-2002H	351	703-2111H	351	710-2021H	353
555036-27181H	166	5716-41550HK	146	610-2111	370	702-2003H	351	703-2112H	351	710-2022H	353
555036-27182H	166	5716i-12020H	146	610-2113	370	702-2004H	351	703-2113H	351	710-2023H	353
555036-32020H	164	5716i-12023H	147	620241-070	111	702-2006H	351	703-2115H	351	710-2024H	353
555036-32050H	164	5716i-12050H	146	620241-072	111	702-2007H	351	703-2117H	351	710-2025H	353
555036-32080H	165	5716i-12053H	147	620241-073	111	702-2008H	351	703-2118H	351	710-2026H	353
555036-32100H	165	5716i-18120H	146	620241-075	111	702-2010H	351	703-2119H	351	710-2027H	353
555036-34090H	165	5716i-18123H	147	620245-072	111	702-2011H	351	703-2120H	351	710-2028H	353
555036-38110H	164	5716i-18124H	147	620249-070	111	702-2012H	351	703-2121H	351	710-2029H	353
555036-42550HK	164	5716i-18210H	146	620249-072	111	702-2014H	351	703-38110	113	710-2030H	353
555036-42580HK	165	5716i-18213H	147	620249-073	111	702-2015H	351	705-2001H	351	710-2031H	353
555038-27180H	166	5716i-18214H	147	620249-075	111	702-2016H	351	705-2002H	351	710-2032H	353
555038-27181H	166	5716i-42550HK	146	620290-070	111	702-2018H	353	705-2003H	351	710-2033H	353

Artikel-Nr.	Seite	Artikel-Nr.	Seite	Artikel-Nr.	Seite	Artikel-Nr.	Seite	Artikel-Nr.	Seite	Artikel-Nr.	Seite
710-2034H	353	715-2001H	352	720-2025H	354	730-2117H	352	760-2121H	352	785-2111H	363
710-2035H	353	715-2002H	352	720-2026H	354	730-2118H	352	761-2001H	356, 363	785-2113H	363
710-2036H	353	715-2003H	352	720-2027H	354	730-2119H	352	761-2002H	356, 363	785-2115H	363
710-2037H	353	715-2004H	352	720-2028H	354	730-2120H	352	761-2003H	356, 363	785-2117H	363
710-2038H	353	715-2005H	352	720-2029H	354	730-2121H	352	761-2004H	356, 363	785-2118H	363
710-2039H	353	715-2006H	352	720-2030H	354	732-18120	113	761-2006H	356, 363	785-2119H	363
710-2040H	353	715-2007H	352	720-2031H	354	759-2001H	356, 363	761-2007H	356, 363	785-2120H	363
710-2041H	355	715-2008H	352	720-2032H	354	759-2002H	356, 363	761-2008H	356, 363	786-2001H	363
710-2042H	355	715-2009H	352	720-2033H	354	759-2003H	356, 363	761-2011H	356, 363	786-2002H	363
710-2043H	355	715-2010H	352	720-2034H	354	759-2004H	356, 363	761-2015H	356, 363	786-2003H	363
710-2044H	355	715-2011H	352	720-2035H	354	759-2006H	356, 363	761-2016H	356, 363	786-2004H	363
710-2045H	355	715-2012H	352	720-2036H	354	759-2007H	356, 363	761-2019H	356, 363	786-2006H	363
710-2046H	355	715-2013H	352	720-2037H	354	759-2008H	356, 363	761-2023H	356, 363	786-2007H	363
710-2047H	355	715-2014H	352	720-2038H	354	759-2011H	356, 363	761-2027H	356, 363	786-2008H	363
710-2048H	355	715-2015H	352	720-2039H	354	759-2015H	356, 363	761-2031H	356, 363	786-2011H	363
710-2049H	355	715-2016H	352	720-2040H	354	759-2016H	356, 363	761-2034H	356, 363	786-2015H	363
710-2050H	355	715-2017H	354	720-2041H	355	759-2019H	356, 363	761-2036H	356, 363	786-2016H	363
710-2111H	351	715-2018H	354	720-2042H	355	759-2023H	356, 363	761-2037H	356, 363	786-2019H	365
710-2112H	351	715-2019H	354	720-2043H	355	759-2027H	356, 363	761-2040H	356, 363	786-2023H	365
710-2113H	351	715-2020H	354	720-2044H	355	759-2031H	356, 363	761-2111H	356, 363	786-2027H	365
710-2114H	351	715-2021H	354	720-2045H	355	759-2034H	356, 363	761-2113H	356, 363	786-2031H	365
710-2115H	351	715-2022H	354	720-2046H	355	759-2036H	356, 363	761-2115H	356, 363	786-2034H	365
710-2116H	351	715-2023H	354	720-2047H	355	759-2037H	356, 363	761-2117H	356, 363	786-2036H	365
710-2117H	351	715-2024H	354	720-2048H	355	759-2040H	356, 363	761-2118H	356, 363	786-2037H	365
710-2118H	351	715-2025H	354	720-2049H	355	759-2111H	356, 363	761-2119H	356, 363	786-2040H	365
710-2119H	351	715-2026H	354	720-2050H	355	759-2113H	356, 363	761-2120H	356, 363	786-2111H	363
710-2120H	351	715-2027H	354	720-2111H	352	759-2115H	356, 363	763-2003H	356	786-2113H	363
710-2121H	351	715-2028H	354	720-2112H	352	759-2117H	356, 363	763-2034H	356	786-2115H	363
711-18120	113	715-2029H	354	720-2113H	352	759-2118H	356, 363	763-2036H	356	786-2117H	363
71152-8110	113	715-2030H	354	720-2114H	352	759-2119H	356, 363	763-2037H	356	786-2118H	363
712-2001H	351	715-2031H	354	720-2115H	352	759-2120H	356, 363	763-2040H	356	786-2119H	363
712-2002H	351	715-2032H	354	720-2116H	352	75917-8110	113	763-2111H	356	786-2120H	363
712-2003H	351	715-2033H	354	720-2117H	352	75918-8110	113	763-2115H	356	78i-32020H	157
712-2004H	351	715-2034H	354	720-2118H	352	760-2001H	352	763-2118H	356	78i-32050H	157
712-2005H	351	715-2035H	354	720-2119H	352	760-2002H	352	763-2120H	356	78i-38110H	157
712-2006H	351	715-2036H	354	720-2120H	352	760-2003H	352	764-2001H	363	806-2038	371
712-2007H	351	715-2037H	354	720-2121H	352	760-2004H	352	764-2002H	363	806-2042	371
712-2008H	351	715-2038H	354	730-2001H	352	760-2005H	352	764-2003H	363	806-2111	371
712-2009H	351	715-2039H	354	730-2002H	352	760-2006H	352	764-2004H	363	806-2113	371
712-2010H	351	715-2040H	354	730-2003H	352	760-2007H	352	764-2006H	363	810-2008	370
712-2011H	351	715-2111H	352	730-2004H	352	760-2008H	352	764-2007H	363	810-2016	370
712-2012H	351	715-2112H	352	730-2005H	352	760-2009H	352	764-2008H	363	810-2023	370
712-2013H	351	715-2113H	352	730-2006H	352	760-2010H	352	764-2011H	363	810-2033	370
712-2014H	351	715-2114H	352	730-2007H	352	760-2011H	352	764-2015H	363	810-2038	370
712-2015H	351	715-2115H	352	730-2008H	352	760-2012H	352	764-2016H	363	810-2039	370
712-2016H	351	715-2116H	352	730-2009H	352	760-2013H	352	764-2019H	365	810-2040	370
712-2017H	353	715-2117H	352	730-2010H	352	760-2014H	352	764-2023H	365	810-2041	370
712-2018H	353	715-2118H	352	730-2011H	352	760-2015H	352	764-2027H	365	810-2042	370
712-2019H	353	715-2119H	352	730-2012H	352	760-2016H	352	764-2031H	365	810-2043	370
712-2020H	353	715-2120H	352	730-2013H	352	760-2017H	354	764-2034H	365	810-2111	370
712-2021H	353	715-2121H	352	730-2014H	352	760-2018H	354	764-2036H	365	810-2113	370
712-2022H	353	717i-12020H	149	730-2015H	352	760-2019H	354	764-2037H	365	811-2038	370
712-2023H	353	717i-12050H	149	730-2016H	352	760-2020H	354	764-2040H	365	811-2042	370
712-2024H	353	717i-18120H	149	730-2017H	354	760-2021H	354	764-2111H	363	811-2111	370
712-2025H	353	717i-18210H	149	730-2018H	354	760-2022H	354	764-2113H	363	811-2113	370
712-2026H	353	717i-41550HK	149	730-2019H	354	760-2023H	354	764-2115H	363	812-2008	370
712-2027H	353	717i-42550HK	149	730-2020H	354	760-2024H	354	764-2117H	363	812-2016	370
712-2028H	353	720-2001H	352	730-2021H	354	760-2025H	354	764-2118H	363	812-2023	370
712-2029H	353	720-2002H	352	730-2022H	354	760-2026H	354	764-2119H	363	812-2033	370
712-2030H	353	720-2003H	352	730-2023H	354	760-2027H	354	764-2120H	363	812-2038	370
712-2031H	353	720-2004H	352	730-2024H	354	760-2028H	354	77i-32020H	154	812-2039	370
712-2032H	353	720-2005H	352	730-2025H	354	760-2029H	354	77i-32050H	154	812-2040	370
712-2033H	353	720-2006H	352	730-2026H	354	760-2030H	354	77i-38110H	154	812-2041	370
712-2034H	353	720-2007H	352	730-2027H	354	760-2031H	354	785-2001H	363	812-2042	370
712-2035H	353	720-2008H	352	730-2028H	354	760-2032H	354	785-2002H	363	812-2043	370
712-2036H	353	720-2009H	352	730-2029H	354	760-2033H	354	785-2003H	363	812-2111	370
712-2037H	353	720-2010H	352	730-2030H	354	760-2034H	354	785-2004H	363	812-2113	370
712-2038H	353	720-2011H	352	730-2031H	354	760-2035H	354	785-2006H	363	813-2038	370
712-2039H	353	720-2012H	352	730-2032H	354	760-2036H	354	785-2007H	363	813-2042	370
712-2040H	353	720-2013H	352	730-2033H	354	760-2037H	354	785-2008H	363	813-2111	370
712-2111H	351	720-2014H	352	730-2034H	354	760-2038H	354	785-2011H	363	813-2113	370
712-2112H	351	720-2015H	352	730-2035H	354	760-2039H	354	785-2015H	363	815-2008	371
712-2113H	351	720-2016H	352	730-2036H	354	760-2040H	354	785-2016H	363	815-2016	371
712-2114H	351	720-2017H	354	730-2037H	354	760-2111H	352	785-2019H	365	815-2023	371
712-2115H	351	720-2018H	354	730-2038H	354	760-2112H	352	785-2023H	365	815-2033	371
712-2116H	351	720-2019H	354	730-2039H	354	760-2113H	352	785-2027H	365	815-2038	371
712-2117H	351	720-2020H	354	730-2040H	354	760-2115H	352	785-2031H	365	815-2039	371
712-2118H	351	720-2021H	354	730-2111H	352	760-2117H	352	785-2034H	365	815-2040	371
712-2119H	351	720-2022H	354	730-2112H	352	760-2118H	352	785-2036H	365	815-2041	371
712-2120H	351	720-2023H	354	730-2113H	352	760-2119H	352	785-2037H	365	815-2042	371
712-2121H	351	720-2024H	354	730-2115H	352	760-2120H	352	785-2040H	365	815-2043	371

Artikel-Nr.	Seite	Artikel-Nr.	Seite	Artikel-Nr.	Seite	Artikel-Nr.	Seite	Artikel-Nr.	Seite	Artikel-Nr.	Seite
815-2111	371	8461-38110H	377	864-2039	371	886-2008	371	902-2115H	362	905-2001H	362
815-2113	371	8461-53150	379	864-2040	371	886-2023	371	902-2116H	362	905-2002H	362
81i-32020H	157	8461-53151	379	864-2041	371	886-2038	371	902-2117H	362	905-2003H	362
81i-32025H	158	8461-53159	379	864-2042	371	886-2039	371	902-2118H	362	905-2004H	362
81i-32027H	158	8461-53320H	379	864-2043	371	886-2040	371	902-2119H	362	905-2005H	362
81i-32050H	157	8461-53321H	379	864-2111	371	886-2041	371	902-2120H	362	905-2006H	362
81i-32055H	158	8461-53322H	379	864-2113	371	886-2042	371	9020-2120H	177	905-2007H	362
81i-32057H	158	8461-53323H	379	8800-B200HK	384	886-2043	371	9020-2240H	177	905-2008H	362
81i-38110H	157	8461-61061HK	379	8800-B600HK	384	886-2111	371	9020-2250H	177	905-2009H	362
81i-38115H	158	8461-7161H	377	8800-B611HK	384	886-2113	371	9020-2270H	177	905-2010H	362
81i-38116H	158	8461-B200HK	377	8800-B670HK	384	900-54420	221	9020-2280H	177	905-2011H	362
81i-38117H	158	8462-32020H	377	8801-B200HK	384	900-54421	221	9020-2821H	177	905-2012H	362
81i-38118H	158	8462-332050HK	377	8801-B600HK	384	900-54422	221	9021-2120H	177	905-2013H	362
8450-332050HK	377	8462-34090H	377	8801-B611HK	384	900-54423	221	9021-2240H	177	905-2014H	362
8450-342550HK	377	8462-342030H	377	8801-B670HK	384	900713-342555HK	378	9021-2250H	177	905-2015H	362
8450-342557HK	378	8462-342550HK	377	8802-B200HK	384	900714-342555HK	378	9021-2270H	177	905-2016H	362
8450-B200HK	377	8462-342580HK	377	8802-B600HK	384	900719-342555HK	378	9021-2280H	177	905-2017H	364
8450-B600HK	377	8462-38110H	377	8802-B611HK	384	900725-342555HK	378	9021-2821H	177	905-2018H	364
8450-B611HK	378	8462-53150	379	8802-B670HK	384	900726-342555HK	378	9022-2120H	177	905-2019H	364
8450-B612HK	378	8462-53151	379	8803-B200HK	384	900R-1100	221	9022-2240H	177	905-2020H	364
8450-B773HK	378	8462-53159	379	8803-B600HK	384	900R-1110	221	9022-2250H	177	905-2021H	364
8450-B774HK	378	8462-53320H	379	8803-B611HK	384	900R-4035	221	9022-2270H	177	905-2022H	364
8451-332050HK	377	8462-53321H	379	8803-B670HK	384	901-37080	167	9022-2280H	177	905-2023H	364
8451-342550HK	377	8462-53322H	379	8804-B200HK	384	901-37081	167	9022-2821H	177	905-2024H	364
8451-342557HK	378	8462-53323H	379	8804-B600HK	384	901-37082	167	9023-2120H	177	905-2025H	364
8451-B200HK	377	8462-61061HK	379	8804-B611HK	384	901-37083	167	9023-2240H	177	905-2026H	364
8451-B600HK	377	8462-7161H	377	8804-B670HK	384	901i-27181H	166	9023-2250H	177	905-2027H	364
8451-B611HK	378	8462-B200HK	377	8810-342030H	384	901i-27182H	166	9023-2270H	177	905-2028H	364
8451-B612HK	378	8463-32020H	377	8810-7161H	384	901i-32020H	164	9023-2280H	177	905-2029H	364
8451-B773HK	378	8463-332050HK	377	8810-B200HK	384	901i-32050H	164	9023-2821H	177	905-2030H	364
8451-B774HK	378	8463-34090H	377	8810-B600HK	384	901i-32080H	165	9024-2120H	177	905-2031H	364
8452-332050HK	377	8463-342030H	377	8811-342030H	384	901i-32100H	165	9024-2240H	177	905-2032H	364
8452-342550HK	377	8463-342550HK	377	8811-7161H	384	901i-34020H	167	9024-2250H	177	905-2033H	364
8452-342557HK	378	8463-342580HK	377	8811-B200HK	384	901i-34090H	165	9024-2270H	177	905-2034H	364
8452-B200HK	377	8463-38110H	377	8811-B600HK	384	901i-38110H	164	9024-2280H	177	905-2035H	364
8452-B600HK	377	8463-53150	379	8812-342030H	384	901i-42550HK	164	9024-2821H	177	905-2036H	364
8452-B611HK	378	8463-53151	379	8812-7161H	384	901i-42580HK	165	9025-2120H	177	905-2037H	364
8452-B612HK	378	8463-53159	379	8812-B200HK	384	902-2001H	362	9025-2240H	177	905-2038H	364
8452-B773HK	378	8463-53320H	379	8812-B600HK	384	902-2002H	362	9025-2250H	177	905-2039H	364
8452-B774HK	378	8463-53321H	379	8813-342030H	384	902-2003H	362	9025-2270H	177	905-2040H	364
8453-332050HK	377	8463-53322H	379	8813-7161H	384	902-2004H	362	9025-2280H	177	905-2111H	362
8453-342550HK	377	8463-53323H	379	8813-B200HK	384	902-2005H	362	9025-2821H	177	905-2112H	362
8453-342557HK	378	8463-7161H	377	8813-B600HK	384	902-2006H	362	9026-2120H	177	905-2113H	362
8453-B200HK	377	8463-B200HK	377	8814-342030H	384	902-2007H	362	9026-2240H	177	905-2114H	362
8453-B600HK	377	8464-32020H	377	8814-7161H	384	902-2008H	362	9026-2250H	177	905-2115H	362
8453-B611HK	378	8464-332050HK	377	8814-B200HK	384	902-2009H	362	9026-2270H	177	905-2116H	362
8453-B612HK	378	8464-34090H	377	8814-B600HK	384	902-2010H	362	9026-2280H	177	905-2117H	362
8453-B773HK	378	8464-342030H	377	8823-B700HK	471	902-2011H	362	9026-2821H	177	905-2118H	362
8453-B774HK	378	8464-342550HK	377	8823-B710HK	471	902-2012H	362	9027-2120H	177	905-2119H	362
8454-332050HK	377	8464-342580HK	377	8823-B729HK	471	902-2013H	362	9027-2240H	177	905-2120H	362
8454-342550HK	377	8464-38110H	377	8823-B770HK	471	902-2014H	362	9027-2250H	177	910-2001H	362
8454-342557HK	378	8464-53150	379	8824-B700HK	471	902-2015H	362	9027-2270H	177	910-2002H	362
8454-B200HK	377	8464-53151	379	8824-B710HK	471	902-2016H	362	9027-2280H	177	910-2003H	362
8454-B600HK	377	8464-53159	379	8824-B729HK	471	902-2017H	364	9027-2821H	177	910-2004H	362
8454-B611HK	378	8464-53320H	379	8824-B770HK	471	902-2018H	364	902R-1100	221	910-2005H	362
8454-B612HK	378	8464-53321H	379	8825-B700HK	471	902-2019H	364	902R-1110	221	910-2006H	362
8454-B773HK	378	8464-53322H	379	8825-B710HK	471	902-2020H	364	902R-4035	221	910-2007H	362
8454-B774HK	378	8464-53323H	379	8825-B729HK	471	902-2021H	364	9030-2120H	177	910-2008H	362
8460-32020H	377	8464-7161H	377	8825-B770HK	471	902-2022H	364	9030-2240H	177	910-2009H	362
8460-332050HK	377	8464-B200HK	377	8826-B700HK	471	902-2023H	364	9030-2250H	177	910-2010H	362
8460-34090H	377	8471-B610HK	314	8826-B710HK	471	902-2024H	364	9030-2270H	177	910-2011H	362
8460-342030H	377	8471-B620HK	314	8826-B729HK	471	902-2025H	364	9030-2280H	177	910-2012H	362
8460-342550HK	377	8471-B629HK	314	8826-B770HK	471	902-2026H	364	9030-2821H	177	910-2013H	362
8460-342580HK	377	8471-B660HK	314	8827-B700HK	471	902-2027H	364	9031-2120H	177	910-2014H	362
8460-38110H	377	8471-B670HK	314	8827-B710HK	471	902-2028H	364	9031-2240H	177	910-2015H	362
8460-53150	379	8471-B690HK	314	8827-B729HK	471	902-2029H	364	9031-2250H	177	910-2016H	362
8460-53151	379	8471-B695HK	314	8827-B770HK	471	902-2030H	364	9031-2270H	177	910-2017H	364
8460-53159	379	8471-B698HK	314	8828-B700HK	471	902-2031H	364	9031-2280H	177	910-2018H	364
8460-53320H	379	8472-B610HK	314	8828-B710HK	471	902-2032H	364	9031-2821H	177	910-2019H	364
8460-53321H	379	8472-B620HK	314	8828-B729HK	471	902-2033H	364	9032-2120H	177	910-2020H	364
8460-53322H	379	8472-B629HK	314	8828-B770HK	471	902-2034H	364	9032-2240H	177	910-2021H	364
8460-53323H	379	8472-B660HK	314	885-2008	371	902-2035H	364	9032-2250H	177	910-2022H	364
8460-61061HK	379	8472-B670HK	314	885-2023	371	902-2036H	364	9032-2270H	177	910-2023H	364
8460-7161H	377	8472-B690HK	314	885-2038	371	902-2037H	364	9032-2280H	177	910-2024H	364
8460-B200HK	377	8472-B695HK	314	885-2039	371	902-2038H	364	9032-2821H	177	910-2025H	364
8461-32020H	377	8472-B698HK	314	885-2040	371	902-2039H	364	9033-2120H	177	910-2026H	364
8461-332050HK	377	864-2008	371	885-2041	371	902-2040H	364	9033-2240H	177	910-2027H	364
8461-34090H	377	864-2016	371	885-2042	371	902-2111H	362	9033-2250H	177	910-2028H	364
8461-342030H	377	864-2023	371	885-2043	371	902-2112H	362	9033-2270H	177	910-2029H	364
8461-342550HK	377	864-2033	371	885-2111	371	902-2113H	362	9033-2280H	177	910-2030H	364
8461-342580HK	377	864-2038	371	885-2113	371	902-2114H	362	9033-2821H	177	910-2031H	364

Artikel-Nr.	Seite	Artikel-Nr.	Seite
910-2032H	364	920-2036H	364
910-2033H	364	920-2037H	364
910-2034H	364	920-2038H	364
910-2035H	364	920-2039H	364
910-2036H	364	920-2040H	364
910-2037H	364	920-2111H	362
910-2038H	364	920-2112H	362
910-2039H	364	920-2113H	362
910-2040H	364	920-2114H	362
910-2111H	362	920-2115H	362
910-2112H	362	920-2116H	362
910-2113H	362	920-2117H	362
910-2114H	362	920-2118H	362
910-2115H	362	920-2119H	362
910-2116H	362	920-2120H	362
910-2117H	362	926-37080	167
910-2118H	362	926-37081	167
910-2119H	362	926-37082	167
910-2120H	362	926i-27180H	166
918-37080	167	926i-27181H	166
918-37081	167	926i-27182H	166
918-37082	167	926i-32020H	164
918i-27180H	166	926i-32050H	164
918i-27181H	166	926i-32080H	165
918i-27182H	166	926i-32100H	165
918i-32020H	164	926i-34020H	167
918i-32050H	164	926i-34090H	165
918i-32080H	165	926i-38110H	164
918i-32100H	165	926i-42550HK	164
918i-34020H	167	926i-42580HK	165
918i-34090H	165	929R-1100	221
918i-34306H	167	929R-1110	221
918i-38110H	164	929R-4035	221
918i-42550HK	164	948D-1010	291
918i-42580HK	165	948D-1630	291
91i-32020H	153	950D-1010	291
91i-32025H	155	950D-1630	291
91i-32027H	155	980-2003H	362
91i-32050H	153	980-2007H	362
91i-32055H	155	980-2011H	362
91i-32057H	155	980-2015H	362
91i-38110H	153	980-2019H	364
91i-38115H	155	980-2023H	364
91i-38116H	155	980-2027H	364
91i-38117H	155	980-2031H	364
91i-38118H	155	980-2039H	364
920-2001H	362	980-2111H	362
920-2002H	362	980-2118H	362
920-2003H	362	980-2120H	362
920-2004H	362		
920-2005H	362		
920-2006H	362		
920-2007H	362		
920-2008H	362		
920-2009H	362		
920-2010H	362		
920-2011H	362		
920-2012H	362		
920-2013H	362		
920-2014H	362		
920-2015H	362		
920-2016H	362		
920-2017H	364		
920-2018H	364		
920-2019H	364		
920-2020H	364		
920-2021H	364		
920-2022H	364		
920-2023H	364		
920-2024H	364		
920-2025H	364		
920-2026H	364		
920-2027H	364		
920-2028H	364		
920-2029H	364		
920-2030H	364		
920-2031H	364		
920-2032H	364		
920-2033H	364		
920-2034H	364		
920-2035H	364		

Format	Serie	Seite(n)
ø 1 cm / 3/8 Inch		
	Loop	256
1 x 20 cm / 3/8 x 8 Inch		
	Basis 1	107
2,5 x 2,5 cm / 1 x 1 Inch		
	Amano	46
	Fresh	222
	Karl	236
	Marble & More	284
	Ocean	316
	Pattern	322
	Plural non-slip	358
	Plural unglasiert	366
	Senja Pure	386
ø 2 cm / 6/8 Inch		
	Loop	256
4 x 60 cm / 1 5/8 x 24 Inch		
	Area Pro	50
	Mandalay	274
	Strata	456
4,5 x 20 cm / 1 13/16 x 8 Inch		
	Basis 1	107
5 x 5 cm / 2 x 2 Inch		
	Alcina	38
	Area Pro	50
	Ascona	86
	Basic Stone	100
	Basis 2	110
	Basis 3	111
	Basis Pro	114
	Cedra	132
	Evalia	202
	Factory	208
	Fresh	222
	Like	246
	Lounge	264
	Nova	302
	Pattern	322
	Plural	338
	Plural non-slip	358
	Plural unglasiert	366
	Quarzit	372
	Savona	380
	Senja Pure	386
	Sento	392
	Sierra	400
	Solid Rock	424
	Stone Duo	438
	Stories	446
	Strata	456
	Trio	472
	Unique	482
	Valley	488
5 x 10 cm / 2 x 4 Inch		
	District	182
5 x 15 cm / 2 x 6 Inch		
	Solid Ground	412
5 x 60 cm / 2 x 24 Inch		
	Solid Ground	412
	Solid Rock	424
	Unique	482
	Valley	488
6 x 50 cm / 2 3/8 x 20 Inch		
	Ascona	86
	Quarzit	372
6 x 60 cm / 2 3/8 x 24 Inch		
	Ascona	86
	Oak	310
	Quarzit	372
	Savona	380
	Streetlife Metallic	468
	Walden	494
6,2 x 25 cm / 2 1/2 x 10 Inch		
	Chroma	140
	Chroma unglasiert	160
	Craft	172
	Ocean	316
6,2 x 50 cm / 2 1/2 x 20 Inch		
	Craft extended	178
7 x 20 cm / 2 13/16 x 8 Inch		
	Basis 3	111

Format	Serie	Seite(n)
7 x 30 cm / 2 13/16 x 12 Inch		
	Area Pro	50
	Basis 3	111
7 x 60 cm / 2 13/16 x 24 Inch		
	Alcina	38
	Area Pro	50
	Aruba	78
	Basis Pro	114
	Cedra	132
	Emotion	190
	Evalia	202
	Factory	208
	Like	246
	Lounge	264
	Nova	302
	Sento	392
	Sierra	400
	Skill	406
	Solid Ground	412
	Solid Rock	424
	Stone Duo	438
	Stories	446
	Strata	456
	Trio	472
	Unique	482
	Valley	488
7,2 x 60 cm / 2 7/8 x 24 Inch		
	Area Pro	50
	Strata	456
7,2 x 120 cm / 2 7/8 x 48 Inch		
	Area Pro	50
	Strata	456
7,2 x 145 cm / 2 7/8 x 58 Inch		
	Area Pro	50
	Strata	456
7,5 x 25 cm / 3 1/8 x 10 Inch		
	Aruba	78
7,9 x 25 cm / 3 1/8 x 10 Inch		
	Chroma unglasiert	160
8 x 60 cm / 3 3/16 x 24 Inch		
	Concrete	168
8,45 x 33 cm / 3 13/32 x 13 13/64 Inch		
	Mando	278
10 x 10 cm / 4 x 4 Inch		
	Area Pro	50
	Basis 2	110
	Basis 3	111
	Emotion Grip	196
	Karl	236
	Pattern	322
	Plural	338
	Plural non-slip	358
	Plural unglasiert	366
	Strata	456
10 x 15 cm / 4 x 6 Inch		
	Basis 3	111
10 x 20 cm / 4 x 8 Inch		
	Area Pro	50
	Basis 3	111
	Emotion Grip	196
	Plural	338
10 x 25 cm / 4 x 10 Inch		
	Ascona	86
	District	182
	Karl	236
10 x 30 cm / 4 x 12 Inch		
	Area Pro	50
	Basis Pro	114
	Emotion Grip	196
	Plural	338
	Strata	456
10 x 50 cm / 4 x 20 Inch		
	Ascona	86
10 x 60 cm / 4 x 24 Inch		
	Area Pro	50
	Ascona	86
	Basis Pro	114
	Cedra	132
	Nova	302
	Quarzit	372
	Solid Rock	424

Format	Serie	Seite(n)
	Strata	456
	Unique	482
	Valley	488
10 x 90 cm / 4 x 36 Inch		
	Cedra	132
12,5 x 12,5 cm / 5 x 5 Inch		
	Ascona	86
	Chroma	140
	Chroma non-slip	150
	Chroma unglasiert	160
	Quarzit	372
12,5 x 25 cm / 5 x 10 Inch		
	Area Pro	50
	Ascona	86
	Chroma	140
	Chroma non-slip	150
	Chroma unglasiert	160
	Craft	172
	Ferrum	218
	Naturkeramik	288
	Ocean	316
	Quarzit	372
12,5 x 50 cm / 5 x 20 Inch		
	Chroma	140
	Plural	338
12,5 x 100 cm / 5 x 40 Inch		
	Plural	338
15 x 15 cm / 6 x 6 Inch		
	Area Pro	50
	Ascona	86
	Basis 1	107
	Basis 2	110
	Basis 3	111
	Basis Pro	114
	Emotion	190
	Nova	302
	Pattern	322
	Plural	338
	Plural unglasiert	366
	Quarzit	372
	Savona	380
	Trio	472
15 x 30 cm / 6 x 12 Inch		
	Basis 1	107
	Plural	338
15 x 60 cm / 6 x 24 Inch		
	Area Pro	50
	Basis Pro	114
	Emotion	190
	Nova	302
	Pizarro	334
	Solid Ground	412
	Solid Rock	424
	Strata	456
	Unique	482
	Valley	488
15 x 90 cm / 6 x 36 Inch		
	Oak	310
15,4 x 15,4 cm / 6 3/16 x 6 3/16 Inch		
	Blindenleitsysteme	122
20 x 20 cm / 8 x 8 Inch		
	Area Pro	50
	Basis 1	107
	Basis 2	110
	Basis 3	111
	Emotion Grip	196
	Pattern	322
	Plural	338
	Plural non-slip	358
	Plural unglasiert	366
20 x 25 cm / 8 x 10 Inch		
	Basis 1	107
20 x 40 cm / 8 x 16 Inch		
	Basis 1	107
	Plural	338
20 x 60 cm / 8 x 24 Inch		
	Valley	488
20 x 120 cm / 8 x 48 Inch		
	Walden	494
24,3 x 43,8 cm / 10 x 18 Inch		
	Alcina	38





Format	Serie	Seite(n)
25 x 8,9 cm / 10 x 3 1/2 Inch		
	Eladuct + KerAion Ela 10 .6.	186
25 x 12,5 cm / 10 x 5 Inch		
	Basis 4.	113
	Eladuct + KerAion Ela 10 .6.	186
	Ferrum.	218
25 x 15,6 cm / 10 x 6 1/4 Inch		
	Ferrum.	218
25 x 25 cm / 10 x 10 Inch		
	Area Pro.	50
	Ascona.	86
	Chroma.	140
	Chroma non-slip.	150
	Chroma unglasiert.	160
	Naturkeramik.	288
	Quarzit.	372
25 x 33 cm / 10 x 13 Inch		
	Basis 1.	107
25 x 50 cm / 10 x 20 Inch		
	Area Pro.	50
	Ascona.	86
	Chroma.	140
	Chroma unglasiert.	160
	Plural.	338
	Quarzit.	372
27,8 x 20 cm / 11 x 8 Inch		
	Emotion Grip.	196
28 x 145 cm / 11 3/16 x 58		
	Area Pro.	50
	Ascona.	86
	Nova.	302
	Quarzit.	372
	Solid Ground.	412
	Strata.	456
30 x 8,7 cm / 12 x 3 1/2 Inch		
	Eladuct + KerAion Ela 10.6.	186
30 x 30 cm / 12 x 12 Inch		
	Area Pro.	50
	Basis 3.	111
	Basis Pro.	114
	Blindenleitsysteme.	122
	Emotion.	190
	Emotion Grip.	196
	New Market.	292
	Plural.	338
	Sento.	392
	Sierra.	400
	Stone Duo.	438
	Stories.	446
	Strata.	456
	Unique.	482
	Valley.	488
30 x 35 cm / 12 x 14 Inch		
	Oak.	310
30 x 44,5 cm / 12 x 18 Inch		
	Like.	246
30 x 60 cm / 12 x 24 Inch		
	Alcina.	38
	Area Pro.	50
	Aruba.	78
	Ascona.	86
	Basis 1.	107
	Basis 1+.	109
	Basis 2.	110
	Basis 3.	111
	Basis Pro.	114

Format	Serie	Seite(n)
	Cedra.	132
	Concrete.	168
	Emotion.	190
	Evalia.	202
	Factory.	208
	Like.	246
	Lounge.	264
	Mandalay.	274
	New Market.	292
	Nivella.	300
	Nova.	302
	Pizarro.	334
	Plural.	338
	Plural non-slip.	358
	Plural unglasiert.	366
	Quarzit.	372
	Savona.	380
	Senja Pure.	386
	Sento.	392
	Sierra.	400
	Skill.	406
	Solid Ground.	412
	Solid Rock.	424
	Stone Concept.	432
	Stone Duo.	438
	Stories.	446
	Strata.	456
	Trio.	472
	Unique.	482
	Valley.	488
30 x 90 cm / 12 x 36 Inch		
	Alcina.	38
	Area Pro.	50
	Aruba.	78
	Basis 1.	107
	Basis 1+.	109
	Cedra.	132
	Evalia.	202
	Factory.	208
	Lounge.	264
	Oak.	310
	Senja Pure.	386
	Trio.	472
30 x 120 cm / 12 x 48 Inch		
	Factory.	208
	Oak.	310
	Skill.	406
	Streetlife Metallic.	468
	Trio.	472
31 x 30 cm / 12 13/64 x 12 Inch		
	Craft extended.	178
31 x 145 cm / 12 3/8 x 58 Inch		
	Area Pro.	50
	Ascona.	86
	Nova.	302
	Quarzit.	372
	Solid Ground.	412
	Strata.	456
35 x 100 cm / 14 x 40 Inch		
	Basis 1.	107
	Bliss.	128
	Mando.	278
	Sento.	392
	Stories.	446
40 x 120 cm / 16 x 48 Inch		
	Oak.	310

Format	Serie	Seite(n)
50 x 25 cm / 20 x 10 Inch		
	Area Pro.	50
	Ascona.	86
	Quarzit.	372
50 x 100 cm / 20 x 40 Inch		
	Ascona.	86
	Plural.	338
60 x 60 cm / 24 x 24 Inch		
	Alcina.	38
	Area Pro.	50
	Aruba.	78
	Ascona.	86
	Basis Pro.	114
	Eladuct + KerAion Ela 10 .6.	186
	Emotion.	190
	Evalia.	202
	Factory.	208
	KerAion OP-Spezialglasuren.	242
	Like.	246
	Lounge.	264
	New Market.	292
	Nova.	302
	Quarzit.	372
	Savona.	380
	Sento.	392
	Skill.	406
	Solid Ground.	412
	Solid Rock.	424
	Stone Duo.	438
	Stories.	446
	Strata.	456
	Streetlife Metallic.	468
	Trio.	472
	Unique.	482
	Valley.	488
60 x 120 cm / 24 x 48 Inch		
	Area Pro.	50
	Aruba.	78
	Factory.	208
	Lounge.	264
	Nova.	302
	Oak.	310
	Savona.	380
	Sento.	392
	Skill.	406
	Solid Ground.	412
	Solid Rock.	424
	Stone Duo.	438
	Strata.	456
	Streetlife Metallic.	468
	Trio.	472
	Unique.	482
	Valley.	488
80 x 80 cm / 32 x 32 Inch		
	Like.	246
90 x 90 cm / 36 x 36 Inch		
	Area Pro.	50
100 x 100 cm / 40 x 40 Inch		
	Stories.	446
120 x 120 cm / 48 x 48 Inch		
	Like.	246
	Lounge.	264
	Solid Ground.	412
	Trio.	472

Format-Nr.	Seiten	Format-Nr.	Seiten	Format-Nr.	Seiten	Format-Nr.	Seiten
1010	291	2821	177	37080	167	54422	221
1100	221	32020H	153, 154, 157, 164, 377	37081	167	54423	221
1110	189, 221	32025H	155, 158	37082	167	61061HK	379
12020H	146, 148, 149	32027H	155, 158	38110	113	6635	127
12023H	147	32050H	153, 154, 157, 164	38110H	153, 154, 157, 164, 377	6636	127
12050H	146, 148, 149	32055H	155, 158	38115H	155, 158	703	351, 353
12053H	147	32057H	155, 158	38116H	155, 158	7161H	377, 384
1630	291	32080H	165	38117H	155, 158	730	352, 354
18120	113	32100H	165	38118H	155, 158	760	352, 354
18120H	146, 148, 149	332050HK	377	4000	189	8110	113
18123H	147	34020H	167	4003	189	9215	181
18124H	147	34090H	165, 377	4004	189	B200HK	377, 384
18210H	146, 148, 149	341550HK	351, 353	4035	221	B600HK	245, 377, 384
18213H	147	342030H	377, 384	41550HK	146, 148, 149	B611HK	378, 384
18214H	147	342550HK	352, 354, 377	42550HK	146, 148, 149, 164	B612HK	378
2120	177	342555HK	378	42580HK	165	B670HK	384
2240	177	342557HK	378	53150	379	B700HK	471
2250	177	342580HK	377	53151	379	B710HK	471
2270	177	34306H	167	53159	379	B729HK	471
2280	177	352010HK	351, 353	53320	379	B770HK	471
2290	181	352050HK	352, 354	53321	379	B773HK	378
2320	181	37040	189	53322	379	B774HK	378
27180H	166	37042	189	53323	379	K100	189
27181H	166	37043	189	54420	221		
27182H	166	37044	189	54421	221		

Agrob Buchtal offeriert bei vielen Serien überglasierte Kanten. Bei **Spalt- und Steinzeugplatten** sind auf Anfrage überglasierte bzw. überglasierte gerundete Kanten gemäß folgender Format-Nummern-Systematik erhältlich:

					
Grundformat-Nr. statt	...1 = Kopfkante	...2 = Längskante	...3 = Ecke links	...4 = Ecke rechts	überglasierte Kanten
Endziffer 0 Endziffer...	...5 = Kopfkante	...6 = Längskante	...7 = Ecke links	...8 = Ecke rechts	überglasierte gerundete Kanten

**Beispiel: Grundformat-Nr. 18120 = 244 x 119 x 6 mm,
Format-Nr. 18123 = überglasierte Ecke links**

Area Pro

Farbe	NCS Hauptfarbe	RAL Hauptfarbe	Color Shade Variation
anthrazit	S7502-B	7024	V2
basalt	S7005-B80G	180 4005	V2
kiesel	S3502-Y	7030	V2
stein	S2502-Y	100 7005	V2
sandweiß	S1502-Y50R	080 8005	V2
sandgrau	S1502-Y50R	080 7005	V2
sand	S5005-Y20R	075 5010	V2
muskat	S7005-Y50R	060 4005	V2
platin	S0500-N	8500	V2
sandbeige	S1005-Y50R	060 8010	V2
ziegel	S7010-Y30R	060 4010	V2
lehm	S8010-Y50R	050 3010	V2

Chroma und Plural

Farbe	ähnlich NCS-Nr.	ähnlich RAL-Nr.	Hellbezugs- wert Y
neutral 1 (Chroma unglasiert)	S9000-N	9017	3
neutral 1	8000	7016	6
neutral 2	S7500-N	7015	9
neutral 3	S6500-N		15
neutral 4	S6000-N	7037	18
neutral 5	S5502-B	7046	21
neutral 6	S4502-B	7045	25
neutral 7	S4000-N	7004	33
neutral 8	S2502-B		46
neutral 9	S1502-R50B		65
neutral 10 (Chroma, Plural)	S1000-N	9003	76
neutral 10 (Chroma unglasiert)	0502-Y	9001	66
neutral 10 (weiß glänzend)	S1500	9003	70
azur aktiv	S5030-R80B	5000	9
azur hell	S2030-R80B		37
azur mittel	S4030-R90B		21
azur dunkel	S4040-R90B	5007	13
blau aktiv	S6030-R90B		7
blau hell	S1510-R80B		60
blau mittel	S2020-R80B		40
blau dunkel	S4030-R80B		17
türkis aktiv	S4030-B50G	6033	22
türkis hell	S1010-B50G		63
türkis mittel	S2020-B30G		44
türkis dunkel	S4020-B30G		26
grün aktiv	S3050-G50Y		26
grün hell	S0510-G		69
grün mittel	S1515-G20Y	6019	53
grün dunkel	S3020-G10Y	6021	31
gelb aktiv	S3050-Y10R		32
gelb hell	S1010-Y10R	1015	69
gelb mittel	S2030-Y10R		50
gelb dunkel	S2050-Y20R		33
ocker aktiv	S3050-Y40R		20
ocker hell	S2030-Y20R		48
ocker mittel	S3030-Y30R		36
ocker dunkel	S4030-Y50R		21
lachs aktiv	S4040-Y70R		15
lachs hell	S1515-Y50R		51
lachs mittel	S2020-Y50R		39
lachs dunkel	S3040-Y60R		23
oxidrot aktiv	S4050-Y90R		10
oxidrot hell	S2010-Y80R		46
oxidrot mittel	S3020-Y80R		25
oxidrot dunkel	S5020-Y80R		15
steingrau aktiv	S5030-Y90R		9
steingrau hell	S2502-R		46
steingrau mittel	S3502-R	7036	34
steingrau dunkel	S6005-Y80R		15
sandgrau aktiv	S7010-Y90R		8
sandgrau hell	S1502-Y		56
sandgrau mittel	S3005-Y50R		35
sandgrau dunkel	S6010-Y50R		14

Sonderfarben

Farbe	ähnlich NCS-Nr.	ähnlich RAL-Nr.	Hellbezugs- wert Y
apfelgrün	S1060-G40Y		39
braun mittel	S5020-Y50R	060 50 20	17
grau mittel	S3502-Y	100 70 05	32
intensivblau	6040-R70B		1
kontrastrot (Chroma non-slip B)	S2050-Y90R	3017	14
kontrastrot (Chroma non-slip C)	S2060-Y90R	3018	15
kontrastrot (Chroma)	S2570-Y90R	3002	10
naturweiß	2005-Y20R	7032	51
orange	S2060-Y50R	2010	24
sandbeige mittel	S1010-Y20R	1001	44
violett	S5020-R50B	4001	13
zitronengelb	1070-Y	1016	52

Intensivfarben

Farbe	ähnlich NCS-Nr.	ähnlich RAL-Nr.	Hellbezugs- wert Y
violett	S3555-R60B	300 30 25	11
beerenrot	S4050-R20B	360 30 35	11
braunrot	S2570-Y90R	3003	10
feuerrot	S1080-R	3002	14
signalorange	S1070-Y30R	060 70 70	39
sonnengelb	S1070-Y	080 70 70	50
gelbgrün	S2050-G40Y	120 60 50	34
seegrün	S4030-G	6000	21
blaugrün	S3040-B50G	190 50 25	23
kobaltblau	S4055-R70B	290 30 40	8

KerAion OP-Spezialglasuren

Farbe	ähnlich NCS-Nr.	ähnlich RAL-Nr.	Hellbezugs- wert Y
beige	0502-Y	1013	69
blau	0530-R90B		46
grau	3000-N	7038	47
grün	2030-B70G	6027	36
hellgrau	1502-G50Y	7047	58
weiß	0500-N	9003	78

Der durchgängige Einsatz des architektonischen Gestaltungsmittels Farbe hat in den letzten Jahren weiter an Bedeutung gewonnen. Deshalb finden Sie als Planungshilfe eine Aufstellung der relevanten Agrob Buchtal-Gestaltungsserien nach:

NCS = Natural Color System

(Nähere Informationen bei: Skandinavian Color Institute AB, - P.O.Box 49022

S-10028 Stockholm · Tel. +46/8/6174700 · Fax +46/8/6174747,

Institut für Farbe – Brigitte Hartmann · Rotes Knie 6 · 74389 Cleebronn

Tel. 07135/12742 · Fax 07135/12737)

RAL-Farbskala

(Nähere Informationen bei: RAL – Deutsches Institut für Gütesicherung und

Kennzeichnung e.V. · Siegburger Straße 39 · D-53757 St. Augustin

Tel. 02241/1605-0 · Fax 02241/1605-11)

Hellbezugswert:

Diese Angabe (Normfarbwert Y) beschreibt die Helligkeit einer Farbe im Vergleich zu einer ideal weißen, nach Stärke, Richtung und Qualität ebenso beleuchteten Fläche. Für ein ideales Weiß gilt: Y = 100, schwarz: Y = 0, d.h. alles auffallende Licht wird zurückgeworfen.

Bitte beachten Sie, dass diese Zuordnungen nur als Orientierungshilfe dienen können und ggf. Originalmuster, die wir Ihnen gerne zur Verfügung stellen, empfehlenswert sind.

Als Leuchtdichtekonstrast wird der Helligkeitsunterschied zweier benachbarter farbiger Flächen bezeichnet. Anhand dieses Wertes kann festgestellt werden, ob es sich um eine kontrastreiche Raumgestaltung handelt, wie sie z.B. von der DIN 32975 „Gestaltung visueller Informationen im öffentlichen Raum zur barrierefreien Nutzung“ gefordert wird.

Nachfolgend finden Sie die entsprechenden Werte für ausgewählte Serien. Diese ergeben sich aus den jeweiligen Hellbezugswerten, die als gemittelte Werte einzelner Messungen angegeben werden. Werte für andere Produkte ermitteln wir gerne auf Anfrage.

Leuchtdichtekonstrast Serie Area Pro										
		anthrazit	basalt	kiesel	stein	sandweiß	sandgrau	sand	muskat	
<i>Hellbezugswert Y</i>		8	13	21	33	50	38	21	14	
anthrazit	8	0,00	0,23	0,44	0,60	0,72	0,64	0,44	0,24	
basalt	13		0,00	0,23	0,43	0,59	0,49	0,24	0,01	
kiesel	21			0,00	0,22	0,41	0,29	0,01	0,22	
stein	33				0,00	0,21	0,08	0,21	0,42	
sandweiß	50					0,00	0,14	0,40	0,58	
sandgrau	38						0,00	0,28	0,48	
sand	21							0,00	0,23	
muskat	14								0,00	
platin	58									
sandbeige	41									
ziegel	14									
lehm	10									

Leuchtdichtekonstrast Serie Ascona							
		shell	sand	pearl	stone	mud	graphite
<i>Hellbezugswert Y</i>		55	50	47	40	27	11
shell	55	0,00					
sand	50	0,05	0,00				
pearl	47	0,08	0,03	0,00			
stone	40	0,16	0,11	0,08	0,00		
mud	27	0,34	0,30	0,27	0,19	0,00	
graphite	11	0,67	0,64	0,62	0,57	0,42	0,00

Leuchtdichtekonstrast Serie Basis Pro						
		anthrazit	basalt	aschbraun	betongrau	sandbeige
<i>Hellbezugswert Y</i>		7	10	20	24	42
anthrazit	7	0,00				
basalt	10	0,14	0,00			
aschbraun	20	0,42	0,26	0,00		
betongrau	24	0,49	0,33	0,07	0,00	
sandbeige	42	0,66	0,53	0,29	0,22	0,00

Leuchtdichtekontrast Serie Area Pro (Fortsetzung)

		platin	sandbeige	ziegel	lehm
<i>Hellbezugswert Y</i>		58	41	14	10
anthrazit	8	0,75	0,66	0,25	0,07
basalt	13	0,63	0,51	0,03	0,16
kiesel	21	0,47	0,32	0,21	0,38
stein	33	0,28	0,11	0,41	0,55
sandweiß	50	0,07	0,11	0,57	0,68
sandgrau	38	0,21	0,04	0,47	0,60
sand	21	0,46	0,31	0,21	0,38
muskat	14	0,62	0,50	0,01	0,17
platin	58	0,00	0,18	0,62	0,72
sandbeige	41		0,00	0,49	0,62
ziegel	14			0,00	0,19
lehm	10				0,00

Leuchtdichtekontrast Serie Emotion (Boden)

		tiefanthrazit	basalt	mittelgrau	hellbeige
<i>Hellbezugswert Y</i>		7	19	32	46
tiefanthrazit	7	0,00			
basalt	19	0,46	0,00		
mittelgrau	32	0,64	0,25	0,00	
hellbeige	46	0,74	0,42	0,18	0,00

Leuchtdichtekontrast Serie Factory

		blue steel	asphalt	bronze grey	aluminium	lime
<i>Hellbezugswert Y</i>		13	14	16	33,5	51,5
blue steel	13	0,00				
asphalt	14	0,04	0,00			
bronze grey	16	0,10	0,07	0,00		
aluminium	33,5	0,44	0,41	0,35	0,00	
lime	51,5	0,60	0,57	0,53	0,21	0,00

Leuchtdichtekonstrast Serie Nova									
		cremebeige	mittelbraun	mittelgrau	basalt	anthrazit	cremebeige bunt	mittelgrau bunt	anthrazit bunt
<i>Hellbezugswert Y</i>		44	18	35	15	6	44	35	9
cremebeige	44	0,00	0,42	0,11	0,49	0,76	0,00	0,11	0,66
mittelbraun	18		0,00	0,32	0,09	0,50	0,42	0,32	0,33
mittelgrau	35			0,00	0,40	0,71	0,11	0,00	0,59
basalt	15				0,00	0,43	0,49	0,40	0,25
anthrazit	6					0,00	0,76	0,71	0,20
cremebeige bunt	44						0,00	0,11	0,66
mittelgrau bunt	35							0,00	0,59
anthrazit bunt	9								0,00

Leuchtdichtekonstrast Serie Quarzit						
		basaltgrau	quarzgrau	sandbeige	sepiabraun	weißgrau
<i>Hellbezugswert Y</i>		15	40	47	30	55
basaltgrau	15	0,00				
quarzgrau	40	0,45	0,00		0,14	
sandbeige	47	0,52	0,08	0,00	0,22	
sepiabraun	30	0,33			0,00	
weißgrau	55	0,57	0,16	0,08	0,29	0,00

Leuchtdichtekonstrast Serie Savona						
		kalk	beige	braun	grau	anthrazit
<i>Hellbezugswert Y</i>		52	38	20	20	8
kalk	52	0,00	0,16	0,44	0,44	0,73
beige	38		0,00	0,31	0,31	0,65
braun	20			0,00	0,00	0,43
grau	20			0,00	0,00	0,43
anthrazit	8					0,00

Leuchtdichtekonstrast Serie Strata									
		lava	vulkan	stein	lehm	ton	quarz	kalk	bims
<i>Hellbezugswert Y</i>		7,4	8,5	12,9	19,2	26,0	32,0	37,0	48,6
bims	48,6	0,74	0,70	0,58	0,43	0,30	0,21	0,14	0,00
kalk	37,0	0,67	0,63	0,48	0,32	0,17	0,07	0,00	
quarz	32,0	0,62	0,58	0,43	0,25	0,10	0,00		
ton	26,0	0,56	0,51	0,34	0,15	0,00			
lehm	19,2	0,44	0,39	0,20	0,00				
stein	12,9	0,27	0,21	0,00					
vulkan	8,5	0,07	0,00						
lava	7,4	0,00							

Leuchtdichtekontrast Serie Trio						
		slate black	mud grey	iron grey	cement grey	ivory white
<i>Hellbezugswert Y</i>		9,9	18,8	19,3	35,1	52,5
slate black	9,9	0,00				
mud grey	18,8	0,31	0,00			
iron grey	19,3	0,32	0,01	0,00		
cement grey	35,1	0,56	0,30	0,29	0,00	
ivory white	52,5	0,68	0,47	0,46	0,20	0,00

Leuchtdichtekontrast Serie Trio Terrazzo				
		terrazzo black	terrazzo red	terrazzo ivory
<i>Hellbezugswert Y</i>		13	19,1	43,5
terrazzo black	13	0,00		
terrazzo red	19,1	0,19	0,00	
terrazzo ivory	43,5	0,54	0,39	0,00

Leuchtdichtekontrast Serie Unique							
		anthrazit	basalt	hellgrau	beige	braun	schlamm
<i>Hellbezugswert Y</i>		6	17	36	45	18	30
anthrazit	6	0,00					
basalt	17	0,48	0,00				
hellgrau	36	0,71	0,36	0,00		0,33	0,09
beige	45	0,76	0,45	0,11	0,00	0,43	0,20
braun	18	0,50	0,03			0,00	
schlamm	30	0,67	0,28			0,25	0,00

Leuchtdichtekontrast Serie Valley					
		schiefer	kieselgrau	erdbraun	sandbeige
<i>Hellbezugswert Y</i>		9	33	10	51
schiefer	9	0,00			
kieselgrau	33	0,57	0,00	0,53	
erdbraun	10	0,05		0,00	
sandbeige	51	0,70	0,21	0,67	0,00



Güteforderungen europäischer Normen

Produktnormen <small>(vereinfacht und auf Format 20x20 cm (BIII), bzw. 30x30cm (BI) bezogen!)</small>	Stranggepresste keram. Fliesen u. Platten, DIN EN 14411		Trockengepresste keram. Fliesen u. Platten, DIN EN 14411		Prüfnormen
	Gruppe AI _a + AI _b „Natur“ „Präzision“	Gruppe AII _a -Teil 1 „Natur“ „Präzision“	Gruppe BI _a + BI _b	Gruppe BIII	
A) Abmessungen + Oberflächen					
1. Länge und Breite	± 2 % ± 1,0%	± 2 % ± 1,25 %	± 0,6 %	± 0,5 %	DIN EN ISO 10545-2
2. Dicke	± 10 % ± 10 %	± 10 % ± 10 %	± 5 %	± 10 %	DIN EN ISO 10545-2
3. Geradheit der Kanten	± 0,6 % ± 0,5 %	± 0,6 % ± 0,5 %	± 0,5 %	± 0,3 %	DIN EN ISO 10545-2
4. Rechtwinkeligkeit	± 1,0 % ± 1,0 %	± 1,0 % ± 1,0 %	± 0,5 %	± 0,5 %	DIN EN ISO 10545-2
5. Ebenflächigkeit					DIN EN ISO 10545-2
5.1 Mittelpunktwölbung	± 1,5 % ± 0,5 %	± 1,5 % ± 0,5 %	± 0,5 %	+ 0,5/-0,3 %	DIN EN ISO 10545-2
5.2 Kantenwölbung	± 1,5 % ± 0,5 %	± 1,5 % ± 0,5 %	± 0,5 %	+ 0,5/-0,3 %	DIN EN ISO 10545-2
5.3 Windschiefe	± 1,5 % ± 0,8 %	± 1,5 % ± 0,8 %	± 0,5 %	± 0,5 %	DIN EN ISO 10545-2
6. Oberflächen mängelfrei	mind. 95 %	mind. 95 %	mind. 95 %	mind. 95 %	DIN EN ISO 10545-2
7. Farbabweichungen	•	•	•	•	DIN EN ISO 10545-16
7.1 Brandfarbentypisierung	•	•	•	•	Deutsche Steinzeug
8. Größensortierung ¹⁾	•	•	•	•	Deutsche Steinzeug
B) Physikalische Eigenschaften				glasiert	
1. Wasseraufnahme im Mittel/ max. Einzelwert	AI _a E ≤ 0,5%/0,6% AI _b 0,5% < E ≤ 3%/3,3%	≤ 6/6,5%	BI _a ≤ 0,5 % BI _b ≤ 3 %	> 10 %	DIN EN ISO 10545-3
2. Biegefestigkeit Klammerwert= min. Einzelwert	AI _a min. 28 (21) N/mm ² AI _b min. 23 (18) N/mm ²	min. 20 (18) N/mm ²	BI _a min. 35 (32) N/mm ² BI _b min. 30 (27) N/mm ²	Dicke < 7,5 mm: 15 N/mm ² Dicke ≥ 7,5 mm: 12 N/mm ²	DIN EN ISO 10545-4
2.1. Bruchlast ≥ 7,5 mm Dicke	AI _a min. 1300 N AI _b min. 1100 N	mind. 950 N	BI _a min. 1300 N BI _b min. 1100 N	mind. 600 N	DIN EN ISO 10545-4
2.2. Bruchlast < 7,5 mm Dicke	mind. 600 N	mind. 600 N	mind. 700 N	mind. 200 N	DIN EN ISO 10545-4
3. Schlagfestigkeit	•	•	•	•	DIN EN ISO 10545-5
4. Widerstand Tiefenverschleiß	≤ 275 mm ³	≤ 393 mm ³	≤ 175 mm ³	–	DIN EN ISO 10545-6
5. Widerstand Glasurabrieb	0-5	0-5	0-5	0-5	DIN EN ISO 10545-7
6. Ausdehnungskoeffizient max.	•	•	•	•	DIN EN ISO 10545-8
7. Temperaturwechselbeständigkeit	•	•	•	•	DIN EN ISO 10545-9
8. Feuchtedehnung	< 0,001mm/m	< 0,001mm/m	ca. 0,001mm/m	ca. 0,01mm/m	DIN EN ISO 10545-10
9. Widerstand gegen Glasurrisse	gefordert	gefordert	gefordert	gefordert	DIN EN ISO 10545-11
10. Wärmeleitfähigkeit	ca. 1 W/mK	ca. 1 W/mK	ca. 1 W/mK	ca. 0,8 W/mK	Deutsche Steinzeug
11. Ableitwiderstand	> 10 ¹⁰ Ohm ³	> 10 ¹⁰ Ohm ³	10 ¹⁰ Ohm	10 ¹⁰ Ohm	DIN EN 1081
12. Dampfdiffusionswiderstand	ca. μ 120.000	ca. μ 120.000	ca. μ 120.000	ca. μ 100.000	DIN EN ISO 12572
13. Frostbeständigkeit	gefordert	nicht gefordert, jedoch von AGROB BUCHTAL erfüllt	gefordert	–	DIN EN ISO 10545-12
14. Licht- und Farbechtheit	•	•	•	•	DIN 51094
15. Hellbezugswert	nach Angabe	nach Angabe	nach Angabe	nach Angabe	Deutsche Steinzeug
16. Brandverhalten	A1/A1 _{fl}	A1/A1 _{fl}	A1/A1 _{fl}	A1/A1 _{fl}	DIN 4102/DIN EN 13501-1
C) Chemische Eigenschaften²⁾					
1. Chemikalienbeständigkeit	siehe Prüfzeugnis	siehe Prüfzeugnis	siehe Prüfzeugnis	siehe Prüfzeugnis	DIN EN ISO 10545-13
2. Beständigkeit gegen Haushalts- chemikalien & Badewasserzusätze	min. GB bzw. UB	min. GB bzw. UB	min. GB bzw. UB	–	
3. Fleckbeständigkeit (glasiert)	min. Kl. 3	min. Kl. 3	min. Kl. 3	min. Kl. 3	DIN EN ISO 10545-14
4. Blei- und Cadmiumabgabe	•	•	•	•	DIN EN ISO 10545-15
5. Hytect	siehe Prüfzeugnis	siehe Prüfzeugnis	siehe Prüfzeugnis	siehe Prüfzeugnis	Deutsche Steinzeug
D) Trittsicherheit					
1. Reibungskoeffizient	•	•	•	–	E-DIN EN ISO 10545-17
1.1 Gewerbebereich (BG) Berufsgenossenschaften	Gruppen R9-13/V4-10	Gruppen R9-13/V4-10	Gruppen R9-13/V4-10	–	DIN EN 16165, Anhang B DGUV-R 108-003 (BGR 181)
1.2 Barfußbereich (BUK) BV-Unfallkassen	Gruppen A/B/C	Gruppen A/B/C	Gruppen A/B/C	–	DIN EN 16165, Anhang A DGUV-I 207-006 (GUV-I 8527)

1) Pakete nach Größenklassen und Brandfarben gekennzeichnet.
 2) Flusssäure und deren Verbindungen ausgeschlossen.
 3) Ausnahmen:
 KerAion ELA 10.6: Ableitwiderstand 10⁶ Ohm DIN EN 1081
 Eladuct 10⁸

Deutsche Steinzeug-Fliesen und -Platten erbringen günstigere Werte als die Normen fordern.

Außerdem sind sie baubiologisch, ökologisch, hygienisch und bakteriologisch unbedenklich; dies ist durch Rohmaterialauswahl, Aufbereitungsart und Brenntechnik gewährleistet.

Alle Angaben sowie Zitate aus Produkt- und Prüfnormen sind als unverbindliche Hinweise zu betrachten. Es gelten die jeweils aktuellsten Fassungen.

Begriffe und Klassifizierung gemäß DIN EN 14411

Alle unsere Fliesen und Platten bestehen aus natürlichen Rohstoffen wie Ton, Quarzsand und Feldspäten, die aufbereitet, veredelt und gebrannt werden. Je nach Anwendungszweck werden sie glasiert (GL) oder unglasiert (UGL) hergestellt. Sie lassen sich gemäß DIN EN 14411 wie folgt einordnen:

Klassifizierung der keramischen Fliesen und Platten nach ihren Gruppen der Wasseraufnahme (E) und ihrer Formgebung

Formgebung	Gruppe I E ≤ 3 %	Gruppe IIa 3 % < E ≤ 6 %	Gruppe IIb 6 % < E ≤ 10 %	Gruppe III E > 10 %
A stranggepresste Fliesen und Platten	Gruppe AIa E ≤ 0,5 % (Anhang M)	Gruppe AIIa-1a) (Anhang B)	Gruppe AIIb-1a) (Anhang D)	Gruppe AIII (Anhang F)
	Gruppe AIb 0,5 % < E ≤ 3 % (Anhang A)	Gruppe AIIa-2a) (Anhang C)	Gruppe AIIb-2a) (Anhang E)	
B trockengepresste Fliesen und Platten	Gruppe BIa E ≤ 0,5 % (Anhang G)	Gruppe BIIa (Anhang J)	Gruppe BIIb (Anhang K)	Gruppe BIIIb) (Anhang L)
	Gruppe BIb 0,5 % < E ≤ 3 % (Anhang H)			

a) Gruppen AIIa und AIIb werden in zwei Teile (Teile 1 und 2) mit verschiedenen Produktanforderungen unterteilt.
b) Gruppe BIII trifft im Wesentlichen für glasierte Fliesen und Platten zu. Es gibt eine geringe Anzahl trockenepresster unglasierter Fliesen und Platten, die mit einer Wasseraufnahme über 10 % hergestellt werden, für die diese Produktgruppe nicht zutrifft.

Im traditionellen Sprachgebrauch stehen:

stranggepresste Fliesen und Platten

(mit A gekennzeichnet)

Fliesen und Platten, die in bestimmter Länge von einem Strang abgeschnitten werden, der aus der plastischen Masse mit einer Strangpresse geformt wurde.

trockengepresste Fliesen und Platten

(mit B gekennzeichnet)

Fliesen und Platten, die aus einer fein gemahlenden und anschließend granulierten Masse unter hohem Druck in Form gepresst werden.

Steinzeugplatten sind frostbeständige flachextrudierte Einzelplatten mit einer Brenntemperatur von ca. 1260 °C.

KerAion ist die einzigartige keramische, flachextrudierte Großflächenplatte von Agrob Buchtal.

Steinzeugfliesen sind frostbeständige, trockenepresste Einzelfliesen mit einer Brenntemperatur bis zu 1200°C.

Feinsteinzeug steht für besonders dicht gesinterte Fliesen und Platten mit einer Wasseraufnahme < 0,5%.

Mosaik sind kleinformatige, auf Bögen verklebte (Fein-)Steinzeugfliesen.

Steingutfiesen sind nicht frostbeständige, trockenepresste Einzelfliesen mit einer Brenntemperatur bis zu ca. 1100°C.

Die Wasseraufnahme E in Gewichts-% wird nach DIN EN ISO 10 545-3 ermittelt.

Beschreibung von Maßen

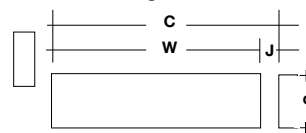

Koordinierungsmaß (C) in cm = Werkmaß (W) + Fuge (J)
Werkmaß (W) in mm = Maße der Ansichtsflächen und Dicke (d)

Abmessungen und Oberflächen

1-5. Abmessungen, DIN EN ISO 10545-2

Alle Maße werden nach der Norm ermittelt.

Zulässige Längen- und Breiten-Toleranzen entsprechend der Produktnormen						
DIN EN 14411	Gruppe AIa / AIb (25x12,5 cm)		Gruppe AIIa (25x12,5 cm)		Gruppe BIIa / BIIb (30x30 cm)	Gruppe BIII (10x10 cm)
	„Natur“	„Präzision“	„Natur“	„Präzision“		
Abweichung vom Herstellmaß	± 2 %, max. 4 mm	± 1 %, max. 2 mm	± 2 %, max. 4 mm	± 1,25 %, max. 2 mm	± 0,6 %, max. 2 mm	± 0,2 %, max. 2 mm
Abweichung von durchschnittl. Seitenlänge	± 1,5 %	± 1,0 %	± 1,5 %	± 1,0 %	± 0,5 %	± 0,5 %

Die Herstellmaße der **Formteile** sind bei uns nach Sichtseiten angegeben.

6. Oberflächenbeschaffenheit, DIN EN ISO 10545-2

Die Oberflächen von 1m² bzw. 30 Stück werden bei 300 Lux aus 1 m Entfernung auf sichtbare Mängel kontrolliert.

7. Farbabweichungen, DIN EN ISO 10545-16

Für glasierte Uni-Waren gilt Δ E_{cmc} < 0,75 als farbgleich, für unglasierter Uni-Waren 1,0.

7.1. Brandfarbensortierung

Die Brandfarbengehörigkeit wird codiert auf die Verpackung gestempelt. Nur gleiche Brandfarben ergeben eine einheitliche Optik. Bei rustikalen Spaltplatten sind größere Farbabweichungen üblich. Es sollte aus diversen Paketen gemischt verlegt werden.

8. Größensortierung

Produktionstechnisch bedingt variieren die Herstellmaße. Das Herstellmaß wird codiert auf die Verpackung gestempelt. Es sollten nur Pakete gleicher Codierung miteinander verlegt werden. Die Differenzen werden gemäß VOB in den Fugen ausgeglichen.

Physikalische Eigenschaften

1. Wasseraufnahme, DIN EN ISO 10545-3

Die **Wasseraufnahme (E)** gibt die Gewichtszunahme von unter Vakuum mit Wasser gesättigten Proben zum Trockengewicht an.

1.1 Rohdichte, DIN EN ISO 10545-3

Sie gibt das Verhältnis zwischen Masse und äußerem Volumen an.

2. Biegefestigkeit, DIN EN ISO 10545-4

Die Bruchkraft F wird an Proben über die Dreipunktbelastung in N ermittelt. Hieraus werden nach folgenden Formeln die Biegefestigkeit und Bruchlast errechnet.

Biegefestigkeit

$$R = \frac{3 \cdot F \cdot L}{2 \cdot b \cdot h^2}$$

F = Bruchkraft in N
 L = Stützweite in mm
 b = Breite in mm
 h = Dicke in mm
 R = Biegefestigkeit

Bruchlast

$$S = \frac{F \cdot L}{b}$$

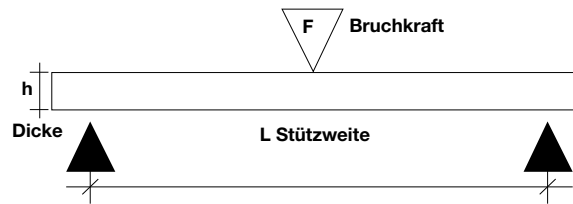

Einsatzmöglichkeiten	Belastungsgruppe
Bruchkraft unter 1.500 N Wohnungsbau und Bodenbeläge mit vergleichbarer mechanischer Beanspruchung, z. B. Hotelbadezimmer, Räume des Gesundheitsdienstes	1
Bruchkraft 1.500 – 3.000 N Verwaltung, Gewerbe und Industrie (befahrbar mit luftbereiften Fahrzeugen), z. B. Großküchen, Kantinen, Verkehrszonen, KFZ-Ausstellungs- und Wartungsräume, Verkaufsräume, jeweils ohne Flurförderfahrzeugverkehr Pressungen bis 2 N/mm ²	2
Bruchkraft 3.000 – 5.000 N Gewerbe und Industrie (Flurförderfahrzeugverkehr mit Superelastik-, Vollgummi- und Vulkollanbereifung), z. B. im Lebensmittel-Einzel- und Großhandel, Nonfood-Einzel- und Großhandel, Ladenpassagen Pressungen bis 2 bis 6 N/mm ²	3
Bruchkraft 5.000 – 8.000 N Gewerbe und Industrie; Anwendungsbereiche wie Gruppe 3, jedoch befahrbar mit Polyamidrollen Pressungen 6 bis 20 N/mm ²	4
Bruchkraft über 8.000 N Gewerbe und Industrie; Schwerlastbereiche mit Flurförderfahrzeugverkehr mit Polyamidrollen; Kollern von Metallteilen, wie z. B. in Fabrikations-, Montage- und Lagerhallen, Reparaturwerkstätten für Maschinen und schweres Gerät Pressungen > 20 N/mm ²	5

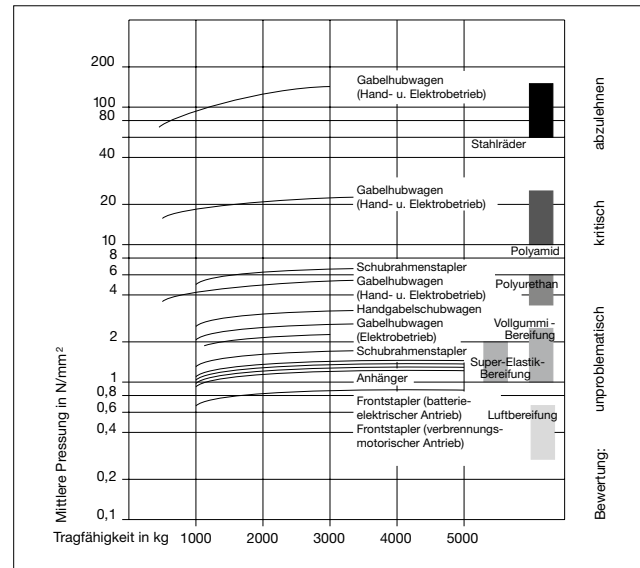

Bodenpressung in N/mm² von Flurfördermitteln nach einer Untersuchung der FMPA in Stuttgart

Die Tabelle verdeutlicht die Beanspruchungen und gibt Hinweise zum Einfluss der Bereifungsart: Stahlräder sind abzulehnen und Polyamid (Nylon + Perlon) weniger günstig. Weichere Bereifungen (≤ 75 Shore-A-Härte) sowie größere Raddurchmesser und breitere Auflagen sind besonders vorteilhaft.

Wichtiger Hinweis:

Bei den „Einsatzmöglichkeiten“ kann es sich naturgemäß nur um eine Empfehlung handeln, da hier Art und Qualität der Verlegung entscheidend sind: Unsere Empfehlung beruht auf üblicher, fachgerechter Verlegung. Mit zunehmender mechanischer Belastung sowie härterer Bereifung ist eine höhere Fliesendicke erforderlich.

Alle Angaben sowie Zitate aus Produkt- und Prüfnormen sind als unverbindliche Hinweise zu betrachten. Es gelten die jeweils aktuellsten Fassungen.

Mechanische Belastbarkeit

Die Deutsche Steinzeug bietet Fliesen und Platten in Dicken von 5 bis hin zu 20 mm auch für extreme Belastungen in Industrie und Gewerbe an.

Die Bruchlastwerte unserer Produkte liegen teils erheblich über denen, die die DIN EN 14411 fordert (Entsprechende Prüfergebnisse werden auf Anforderung zur Verfügung gestellt).

Die ermittelte Bruchlast gibt Aufschluss über die Eignung für mechanisch belastbare Böden. Die Beanspruchung selbst erfolgt mehr auf Biegung als auf Druck. Die „Überstarken“ aus unserem Programm mit ihren hohen Druck-, Bruch- und Biegefestigkeitswerten sind der ideale Belag für hochbelastete Böden. Sie widerstehen den Rädern von Flurförderfahrzeugen, Gabelstaplern und Hubwagen mit ihren hohen Bodenpressungen. Besonders sind sie geeignet für die Industrie-Logistik, Groß- und Supermarktböden.

3. Druckfestigkeit

Die Druckfestigkeit von Fliesen und Platten ist nicht genormt. Sie erreicht bei Steinzeugfliesen Werte bis zu 150 N/mm². Die folgende Umrechnungstabelle zeigt die Wichtigkeit einer optimalen und fachgerechten Einbettung der Fliesen vor Ort. Die relativ schwachen Werte von Zement- und Dünnbettmörtel können nur durch eine besondere und fachgerechte Verlegung (Mörtelzusammensetzung, Wasser/Zementwert und manuelle bzw. mechanische Verdichtung) kompensiert werden.

4. Schlagfestigkeit, DIN EN ISO 10545-5

Rückprallmessung an 5 Mustern.

5. Tiefenverschleiß, DIN EN ISO 10545-6

Beim Tiefenverschleiß unglasierter Fliesen und Platten wird mittels Schmelzkorund und einer Schleifscheibe die Abrasion ermittelt.

Je niedriger der Wert, desto verschleißfester das Material.

6. Glasurabrieb, DIN EN ISO 10545-7

Die **Verschleißklasse** glasierter Fliesen und Platten wird im Nasstest ermittelt. Mittels Schmelzkorund und Stahlkugeln sowie Wasserzugabe in einem exzentrisch kreisenden System wird künstlich Abrieb erzeugt. Die Anzahl der Umdrehungen bei sichtbarer Veränderung der Verschleißfläche ergibt die Klassifizierung:

Widerstand gegen Oberflächenverschleiß	
Klasse	Umdrehungen
0	100
1	150
2	600
3	750/1500
4	2100/6000/12000
5	>12000*

* Muss die Fleckenprüfung nach DIN EN ISO 10545-14 bestehen.

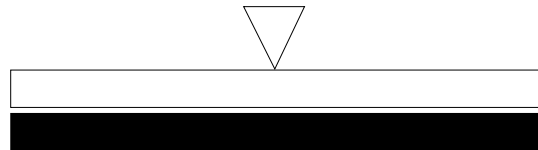

Steinzeug hat eine ca. 10-20 fach höhere Druckfestigkeit als Zementmörtel, Estrich und Stahlbeton.

Umrechnungstabelle verschiedener Materialien

Materialarten	N/mm ²	N/cm ²	kN/cm ²
Steinzeugfliesen	100 – 150	10.000 – 15.000	10 – 15
Steinzeug- und Spaltplatten	180 – 250	18.000 – 25.000	18 – 25
Zementmörtel Gr. III	10	1.000	1
Zementmörtel hochwertig	20	2.000	2
Dünnbettmörtel	15 – 30	1.500 – 3.000	1,5 – 3
Epoxidharze	60 – 75	6.000 – 7.500	6 – 7,5
Zementestrich CT, C12 (ZE 12)	12	1.200	1,2
CT, C20 (ZE 20)	20	2.000	2
CT, C30 (ZE 30)	30	3.000	3
Hartstoffestrich 65	65	6.500	6,5
Stahlbeton C 20/25 (B 25)	25	2.500	2,5
C 30/37 (B 35)	35	3.500	3,5

Klasse 0

Glasierte Fliesen und Platten dieser Klasse werden nicht zur Herstellung vom Bodenbelägen empfohlen.

Klasse 1

Bodenbeläge in Bereichen, die hauptsächlich mit Schuhen mit weicher Sohle oder barfuß ohne kratzende Verschmutzung begangen werden (z. B. Wohnbäder und Schlafzimmer ohne direkten Zugang von außen).

Klasse 2

Bodenbeläge in Bereichen, die mit weichen besohnten oder normalen Schuhen mit höchstens geringen Mengen kratzender Verschmutzungen gelegentlich begangen werden (z. B. Räume in Wohnbereichen von Häusern, mit Ausnahme von Küchen, Eingängen und ähnlichen Räumen, die häufig begangen werden). Dies gilt nicht für Sonderfußbekleidung z. B. Nagelschuhe.

Klasse 3

Bodenbeläge in Bereichen, die mit normalen Schuhen häufig mit geringen Mengen kratzender Verschmutzung begangen werden (z. B. Wohnküchen, Flure, Korridore, Balkone, Loggien und Terrassen). Dies gilt nicht für Sonderfußbekleidung z. B. Nagelschuhe.

Klasse 4

Bodenbeläge, die bei regelmäßiger Nutzung mit geringen Mengen kratzender Verschmutzung begangen werden, so dass die Beanspruchungen stärker sind als bei Klasse 3 (z. B. gewerbliche Küchen, Hotels, Ausstellungs- und Verkaufsräume).

Klasse 5

Bodenbeläge, die durch starken Fußgängerverkehr über lange Zeiträume mit geringen Mengen kratzender Verschmutzung beansprucht werden, so dass die Beanspruchungen die äußersten sind, unter denen glasierte Fliesen und Platten anwendbar sein können (z. B. öffentliche Bereiche wie Einkaufszentren, Eingangshallen auf Flughäfen, Hotelfoyers, öffentliche Fußwege und industrielle Anwendungen).

Jeder genutzte Bodenbelag unterliegt dem Verschleiß. Dieser ist abhängig vom Anwendungsbereich und der Häufigkeit der Begehung, von Art und Grad der Verschmutzung, sowie Härte und Verschleißfestigkeit des Belagsmaterials. Während unglasierte Steinzeugbodenfliesen praktisch keine Anwendungseinschränkungen erfordern, sind glasierte Bodenfliesen und -platten nach Beanspruchungsgruppen zu unterscheiden. Abstreifer, Matten und dergleichen ermöglichen es, Schmutz und Verschleißmittel abzustreifen und vom glasierten Bodenbelag fernzuhalten. Eine derartige Schmutzschleuse muss besonders für solche Räume vorgesehen werden, die direkt von der Straße oder vom Garten her zugänglich sind.

Extreme Beanspruchung

Dafür empfehlen wir die Verwendung von durchgefärbten, unglasierten Fliesen und Platten, die in einer Vielzahl von Farben und Formaten zur Verfügung stehen. Beispiele: Böden mit starkem Publikumsverkehr, wie z. B. in Supermärkten, Hotels, Schulen, Verwaltungsgebäuden, Bahnhöfen, Krankenhäusern, Passagen usw. unter Berücksichtigung mechanischer Beanspruchung.

7. Ausdehnungskoeffizient, DIN EN ISO 10545-8

Der Ausdehnungskoeffizient wird zwischen Raumtemperatur und 100°C ermittelt. Gemessene Werte liegen um ca. $6,0 \times 10^{-6} \text{ m}/(\text{mxK})$ bei Steinzeug und ca. $8,0 \times 10^{-6} \text{ m}/(\text{mxK})$ bei Feinsteinzeug. Bei 8 m Länge und 50° Temperaturdifferenz ergeben sich somit bei Steinzeug ca. 2,4 mm Längenänderung (bei Estrich/Beton, 4,6 mm und Stahl 5,6 mm).

8. Temperaturwechselbeständigkeit, DIN EN ISO 10545-9

Die Temperaturwechselbeständigkeit wird zwischen 15° und 145° geprüft.

9. Feuchtedehnung, DIN EN ISO 10545-10

Die Feuchtedehnung wird zwischen getemperten und wasser-gesättigten Proben ermittelt.

10. Glasurrissefreiheit, DIN EN ISO 10545-11

Diese Prüfung erfolgt im Autoklaven bei 500 kPa mit anschließender Kontrolle nach Einfärbung. Glasuren mit Haarrissen/Craquele werden als solche gekennzeichnet und erfordern ein Vornässen des Belages vor dem Verfugen, um Ablagerungen von feinen Partikeln des Fugmörtels in den Haarrissen vorzubeugen. Farbige Fugmassen eignen sich hierbei nicht. Die Glasuroberflächen dürfen nicht mit Filzstift etc. beschrieben werden.

11. Wärmeleitfähigkeit u.ä.

Wärmeleitfähigkeit, -abstrahlung, -speicherfähigkeit und -durchlasswiderstand sind nicht genormt. Bei Steinzeug ergeben sich folgende ca.-Werte:

Wärmeleitfähigkeit:	1 W/mK	Wärmespeicherfähigkeit:	0,8 kJ/kgK
Wärmeabstrahlung:	5,3 W/m²K²	Wärmedurchlasswiderstand:	0,01 m² K/W

12. Ableitwiderstand

Mit einem Durchgangswiderstand von $>10^{10} \text{ Ohm}$ (DIN EN 1081) ist unsere Keramik im trockenen Zustand isolierend. Wir bieten jedoch mit den Serien Eladuct und KerAion ELA 10.6 Keramik für elektrisch ableitfähige Fußböden an. Die Glasur der ELA 10.6 weist einen Oberflächenwiderstand von ca 10^6 Ohm nach DIN EN 1081 auf. Die Ableitung elektrischer Ladungen erfolgt von der Glasur über leitfähig auszuführende Fugen und Fliesenkleber in elektrisch zu erdende Kupferleitbahnen, die auf dem zu fliesenden Untergrund verlegt werden. Bei Eladuct ist der komplette Plattenkörper ableitfähig. Der Durchgangswiderstand nach DIN EN 1081 beträgt ca. 10^6 Ohm . Leitfähige Fugen erübrigen sich hier, ansonsten ist der Unterbau auszuführen wie für ELA 10.6 beschrieben!

13. Dampfdiffusionswiderstand

Der Wasserdampfdiffusionswiderstand ist nach DIN EN ISO 12572 ca. $\mu 120.000$ bei Steinzeug/Spaltplatten und $\mu 100.000$ bei Steingut (ohne Fugenteile).

14. Frostbeständigkeit, DIN EN ISO 10545-12

Die Frostbeständigkeitsprüfung erfolgt an 10 Stück bzw. > 0,25 m² Proben. Nach einer Wassersättigung unter Vakuum wird nach 100 Frost-Tau-Wechseln die Unversehrtheit geprüft.

Die Frostbeständigkeit eines Außenbelages ist jedoch nicht allein von der Güte der verwendeten keramischen Fliesen und Platten abhängig. **Eine fachgerechte Konstruktion und Verlegung sind zwingend.** Beachten Sie dazu bitte unsere Ausschreibungstexte und das Merkblatt des Zentralverbandes des Deutschen Baugewerbes „Belagskonstruktionen mit Fliesen und Platten außerhalb von Gebäuden“.

15. Licht- und Farbechtheit

Sowohl glasierte als auch unglasierte Keramik ist auf Dauer licht- und farbecht gemäß DIN 51094.

16. Hellbezugswert

Der Hellbezugswert einer Fliese/Platte beschreibt die Helligkeit der Oberfläche, wie sie das menschliche Auge empfindet. Der Messwert

Y = 100 entspricht hierbei der Helligkeit einer absolut weißen Fläche und Y = 0 der einer absolut schwarzen Fläche. Der Hellbezugswert wird bei Unifliesen/-platten ermittelt.

17. Brandverhalten

Keramische Fliesen und Platten entsprechen gemäß EN ISO 13501-1 und DIN EN 14411 der Klasse A1. Sie sind demnach grundsätzlich unbrennbar und somit feuerhemmend. Auch im Brandfall geben sie keine toxischen Emissionen frei.

Chemische Eigenschaften

1. Chemische Beständigkeit, DIN EN ISO 10545-13**Beständigkeit gegen Haushaltschemikalien und Badwasserzusätze**

- Haushaltchemikalien
 - Ammoniumchloridlösung 100g/l
- Schwimmbadsalze
 - Natriumhypochloridlösung 20mg/l

Klassen

A/B/C*

Beständigkeit gegen Säuren und Laugen

- Geringe Konzentration (L)
 - a) Salzsäurelösung 3% (V/V)
 - b) Zitronensäurelösung 100g/l
 - c) Kaliumhydroxidlösung 30g/l
- Hohe Konzentration (H)
 - a) Salzsäurelösung 18% (V/V)
 - b) Milchsäurelösung 5% (V/V)
 - c) Kaliumhydroxidlösung 100g/l

Klassen

LA/LB/LC bzw. HA/HB/HC*

Säureschutzbau und Apparatebau

Die Beständigkeit für den Säureschutzbau DIN EN 993-16 oder den chem. Apparatebau DIN 28062 ist Einzelprüfungen vorbehalten.

* Klasse A weist hierbei die höchste chemische Beständigkeit auf, die nach C immer mehr abnimmt.

2. Fleckbeständigkeit, DIN EN ISO 10545-14**Fleckenbildner**

- Spurenbildende Fleckenbildner
 - Grüne Fleckenbildner in Öl
 - Rote Fleckenbildner in Öl
- Fleckenbildner chemisch
 - Jod, 13g/l in Alkohol
- Filmbildende Fleckenbildner
 - Olivenöl

Reinigung (im Rahmen der Prüfung)

- Reinigungsmittel
 - Heißes Wasser (+55 °C)
 - Schwaches Reinigungsmittel
 - Starkes Reinigungsmittel
- Lösungsmittel
 - Salzsäurelösung 3% (V/V)
 - Kaliumhydroxid 200g/l
 - Aceton

Klassen

Kl. 5 / Kl. 4 / Kl. 3 / Kl. 2 / Kl. 1*

3. Blei- und Cadmiumabgabe

Die glasierten Oberflächen werden einer 4%igen Essigsäure-Lösung ausgesetzt. Anschließend wird die Menge des abgegebenen Bleis und Cadmiums bestimmt.

* Klasse 5 weist hierbei die höchste Fleckbeständigkeit auf, die nach 1 immer mehr abnimmt.

Oberflächenveredelungen und -vergütungen

Hytect

Hytect ist eine hochwirksame und dauerhafte Veredelung von Fliesen und Platten der Deutschen Steinzeug. Die eingebrannte Veredelung auf der Basis von Titandioxid wirkt nach dem Prinzip der Photokatalyse. Es ergeben sich folgende Nutzer-Vorteile:

A) Hytect zersetzt Bakterien und Keime

Unter dem Einfluss von Sonnenlicht oder künstlicher Beleuchtung wird die Oberfläche reaktiv. Es erfolgt die Bildung von aktiviertem Sauerstoff. Dieser zersetzt Mikroorganismen.

B) Hytect baut störende Gerüche ab

Auch störende, lästige oder sogar gesundheitsschädliche Geruchsstoffe in der Luft werden durch Hytect abgebaut.

C) Hytect vermindert den Reinigungsaufwand

Die hydrophile Oberfläche bewirkt die Unterwanderung des Schmutzes durch Wasser. Somit ergibt sich eine erhebliche Reduzierung von Reinigungsmitteln, d. h. Kosteneinsparung und Umweltschutz, sowie ein geringerer manueller Zeitaufwand.

Hytect-Oberflächen sind geruchsneutral, ungiftig, entsprechen Lebensmittelanforderungen und sind für Allergiker unbedenklich.

Für die Verlegung und Verfugung ergeben sich keine Änderungen zu den üblichen Verfahrensweisen. Als Reiniger sind die üblichen Mittel (ohne Flusssäure und deren Verbindungen) anwendbar. Ausgenommen sind alle filmbildenden, rückfettenden oder imprägnierenden Zusätze, welche die Oberflächenaktivierung durch Licht stören.

Namhafte Institute im In- und Ausland haben uns die entsprechenden Wirkungsweisen von Hytect bestätigt.

Protecta-Oberflächenvergütung



Das Bessere ist der Feind des Guten...

Unglasierte Steinzeugfliesen sind grundsätzlich strapazierfähig und unempfindlich. Mit der keramischen Vergütung Protecta wird die Flecken- und Schmutzunempfindlichkeit nochmals entscheidend verbessert. Die **werkseitig** aufgebrachte Vergütung geht während des Brennens eine innige Verbindung mit dem Fliesenkörper ein und verschließt die bei unglasierter Keramik quo natura vorhandenen „Mikro-Poren“. Dadurch wird das Eindringen fleckbildender Substanzen verhindert. Eine Imprägnierung ist hier nicht mehr erforderlich und bei trittsicheren Protecta-vergüteten Fliesen unter Umständen sogar schädlich, da das Imprägniermittel nicht in die Fliese eindringen kann, sondern als Schmierfilm auf der Oberfläche verbleibt.

Protectavergütete Produkte sind bei den entsprechenden Serien mit dieser Bildmarke gekennzeichnet:



Hygiene

Glasierte sowie Protecta-vergütete Fliesen und Platten der Deutschen Steinzeug liefern die besten hygienischen Voraussetzungen. Durch die geschlossene Oberfläche bieten Sie keine Möglichkeit zum Keimwachstum. Untersuchungen von Hygiene-Instituten bestätigen die Eignung für die Auskleidung von Trinkwasserbehältern. Übersensible Personen wie Allergiker machen mit Fliesen und Platten beste Erfahrungen.

Reinigung

Grundsätzlich sind Bekleidungen und Beläge vor intensiven Verschmutzungen, welche insbesondere durch Folgegewerke des Bauablaufs (Malerarbeiten o. ä.) entstehen können, durch geeignete Maßnahmen zu schützen.

Die Reinigung unserer Fliesen und Platten erfolgt üblicherweise mit Wasser und einem neutralen oder alkalischen Reinigungsmittel. Bei hartem Wasser ist sporadisch der Einsatz von sauren Reinigern erforderlich. Bei Fleckenverunreinigungen ist die Reinigung von der Art der Flecken abhängig und mit geeigneten Chemikalien durchzuführen.

Ein Nachwischen mit klarem Wasser ist bei höherer Konzentration des eingesetzten Reinigungsmittels erforderlich. Bei Grundreinigungen ist ein Klarspülen unbedingt nötig. Pflegemittelhaltige Reiniger lehnen wir ab. Sie vermindern üblicherweise die Trittsicherheit und führen zu einem negativen optischen Erscheinungsbild des Bodenbelags durch Aufbau entsprechender Schichten!

Achtung: Bei Bestückung von Reinigungsmaschinen mit Pads, die Schleifkorn enthalten, kommt es zu einem Poliervorgang durch den die Trittsicherheit der Fliesen und Platten erheblich reduziert wird. Wir lehnen deshalb solche Methoden ausdrücklich ab. Flusssäure oder deren Verbindungen greifen die Keramik an und führen zu einer irreversiblen Schädigung!

Eine ausführliche Reinigungsanleitung für keramische Fliesen finden Sie im Internet unter www.agrob-buchtal.de

- Service
- Architekten & Planer/Fachhändler/Fliesenleger
- Reinigungsanleitung.

Imprägnierung

Unglasiertes Steinzeug, das nicht Protecta-vergütet oder Hytect ist, sollte imprägniert werden, um das Eindringen gefärbter Flüssigkeiten, sowie von Fetten und Ölen zu verhindern und die Reinigung zu erleichtern.

Die Imprägnierung ist auf sauberen und trockenen Böden aufzubringen, Überschüsse sind sofort zu entfernen.

Trittsicherheit

1. Reibungskoeffizient/Trittsicherheit/Rutschhemmung

Die Arbeitsstättenverordnung und die Unfallverhütungsvorschriften verlangen, dass Fußböden eben, rutschhemmend und reinigungsfreundlich sein müssen. Besondere Schutzmaßnahmen gegen Ausgleiten sind erforderlich, wenn durch den Umgang mit Wasser, Öl, Schlamm, Fett oder Abfällen Rutschgefahr besteht. Bei der Auswahl der Belagstoffe ist darauf Rücksicht zu nehmen. Diese klare Forderung stützt sich auf Untersuchungen der Versicherungsträger, die ergaben, dass unter allen Unfallursachen das Ausrutschen an erster Stelle steht.

1.1. Gewerbebereiche

Zuständig: Deutsche Gesetzliche Unfallversicherung, Mittelstraße 51, 10117 Berlin-Mitte, Telefon: +49-30-28876-3800, Fax: -3808, www.dguv.de, info@dguv.de
 Prüfnormen: DIN EN 16165 und DIN 51133
 Richtlinie: ASR A 1.5 - Fußböden
 Merkblatt: DGUV-Regel 108-003 „Fußböden in Arbeitsräumen und Arbeitsbereichen mit Rutschgefahr.“ (bisherige BGR 181)
 Prüfverfahren: Schiefe Ebene, Begehung mit Sicherheitsschuhen, Gleitmedium Öl.
 Die Oberflächengestaltung kann eben, feinrauh, rau oder profiliert sein.

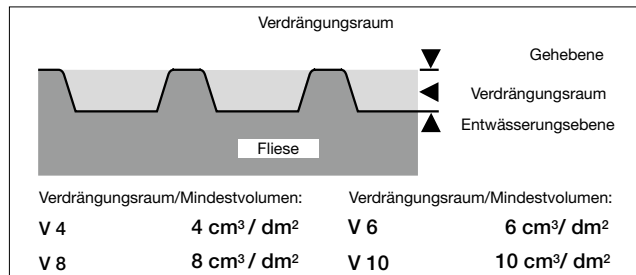

Der Verdrängungsraum (V4-V10) ist der offene Hohlraum zwischen oberer Geh- und Entwässerungsebene bei profilierten Oberflächen.

Trittsichere Fliesen sind bei den entsprechenden Serien mit dem Logo „GRIP“ gekennzeichnet:



Bewertungsgruppen

Die geforderten Bewertungsgruppen sind in einer detaillierten Tabelle gleitgefährdeter Arbeitsbereiche zusammengestellt (siehe nächste Seite). Die Deutsche Gesetzliche Unfallversicherung und Agrob Buchtal geben Auskunft.

Test auf „Schiefer Ebene“

Bewertungs-Gruppen	Neigungswinkel	Gewerbebereich
R9	>6° - 10° geringer Haftreibwert	
R10	>10° - 19° normaler Haftreibwert	
R11	>19° - 27° erhöhter Haftreibwert	
R12	>27° - 35° großer Haftreibwert	
R13	>35° sehr großer Haftreibwert	

Die angegebenen Neigungswinkel dienen ausschließlich zur Zuordnung der Bewertungsgruppen und sind nicht mit den Neigungswinkeln von Schrägen/Rampen gleichzusetzen.

Gesetzesgrundlage

Die Arbeitsstättenverordnung als auch die Unfallverhütungsvorschriften verlangen, dass Fußböden eben, rutschhemmend und leicht zu reinigen sein müssen. Detaillierte Anforderungen enthält die „Technische Regel für Arbeitsstätten“ ASR A 1.5 - Fußböden

Herausgeber:

Bundesanstalt für Arbeitsschutz und Arbeitsmedizin (Ausschuss für Arbeitsstätten)

Bezugsquelle:

Download unter www.baua.de

0	Allgemeine Arbeitsräume und -bereiche*	
0.1	Eingangsbereiche, innen**)	R9
0.2	Eingangsbereiche, außen	R11 (oder R10 V4)
0.3	Treppen, innen***)	R9
0.4	Außentreppen	R11 (oder R10 V4)
0.5	Schrägrampen, innen***) (ab 3 % Steigung; z. B. Rollstuhlrampen, Ausgleichsschragen, Transportwege)	Eine R-Gruppe höher als für den Zugangsbelag erforderlich V-Wert des Zugangsbelags, falls zutreffend
0.6	Sanitärräume	
0.6.1	Toiletten	R9
0.6.2	Umkleide- und Waschräume)	R10
0.7	Pausenräume (z.B. Aufenthaltsraum, Betriebskantinen)	R9
0.8	Erste-Hilfe-Räume und vergleichbare Einrichtungen (siehe ASR A4.3)	R9
1	Herstellung von Margarine, Speisefett, Speiseöl	
1.1	Fettschmelzen	R13 V6
1.2	Speiseölraffinerie	R13 V4
1.3	Herstellung und Verpackung von Margarine	R12
1.4	Herstellung und Verpackung von Speisefett, Abfüllen von Speiseöl	R12
2	Milchbe- und -verarbeitung, Käseherstellung	
2.1	Frischmilchverarbeitung einschließlich Buttereier	R12
2.2	Käsefertigung, -lagerung und Verpackung	R11
2.3	Speiseeisfabrikation	R12
3	Schokoladen- und Süßwarenherstellung	
3.1	Zuckerkochei	R12
3.2	Kakaoherstellung	R12
3.3	Rohmassenherstellung	R11
3.4	Eintafelei, Hohlkörper- und Pralinenfabrikation	R11
4	Herstellung von Backwaren (Bäckereien, Konditoreien, Dauerbackwaren-Herstellung)	
4.1	Teigbereitung	R11
4.2	Räume, in denen vorwiegend Fette oder flüssige Massen verarbeitet werden	R12
4.3	Spülräume	R12 V4
5	Schlachtung, Fleischbearbeitung, Fleischverarbeitung	
5.1	Schlachthaus	R13
5.2	Kuttleraum, Darmschleimerei	R13
5.3	Fleischzerlegung	R13 V8
5.4	Wurstküche	R13 V8
5.5	Kochwurstabteilung	R13 V8
5.6	Rohwurstabteilung	R13 V6
5.7	Wursttrockenraum	R12
5.8	Darmlager	R12
5.9	Pökelei, Räucherei	R12
5.10	Geflügelverarbeitung	R12 V6
5.11	Aufschnitt- und Verpackungsabteilung	R12
5.12	Handwerksbetrieb mit Verkauf	R12 V8 ****)
6	Be- und Verarbeitung von Fisch, Feinkosterstellung	
6.1	Be- und Verarbeitung von Fisch	R13
6.2	Feinkosterstellung	R13 V6
6.3	Mayonnaiseherstellung	R13 V4
7	Gemüse- und -verarbeitung	
7.1	Sauerkrautherstellung	R13 V6
7.2	Gemüsekonservenherstellung	R13 V6
7.3	Sterilisierräume	R11
7.4	Räume, in denen Gemüse für die Verarbeitung vorbereitet wird	R12 V4

8 Nassbereiche bei der Nahrungsmittel- und Getränkeherstellung
(soweit nicht besonders erwähnt)

8.1	Lagerkeller, Gärkeller	R10
8.2	Getränkeabfüllung, Fruchtsaftherstellung	R11

9 Küchen, Speiseräume

9.1	Gastronomische Küchen (Gaststättenküchen, Hotelküchen)	R12
9.2	Küchen für Gemeinschaftsverpflegung in Heimen, Schulen, Kindertageseinrichtungen, Sanatorien	R11
9.3	Küchen für Gemeinschaftsverpflegung in Krankenhäusern, Kliniken	R12
9.4	Großküchen für Gemeinschaftsverpflegung in Mensen, Kantinen und Fernküchen	R12
9.5	Aufbereitungsküchen (Fast Food-Küchen, Convenience- und Imbissbetriebe)	R12
9.6	Auftau- und Anwärnküchen	R10
9.7	Kaffee- und Teeküchen, Küchen in Hotels-Garni, Stationsküchen	R10
9.8	Spülräume	
9.8.1	Spülräume zu 9.1, 9.4, 9.5	R12 V4
9.8.2	Spülräume zu 9.2	R11
9.8.3	Spülräume zu 9.3	R12
9.9	Speiseräume, Gasträume, Kantinen einschließlich Serviergängen	R9
9.10	Thekenbereich, Schankbereich	R10

10 Kühlräume, Tiefkühlräume, Kühlhäuser, Tiefkühlhäuser

10.1	für unverpackte Ware	R12
10.2	für verpackte Ware	R11

11 Verkaufsstellen, Verkaufsräume

11.1	Warenannahme Fleisch	
11.1.1	für unverpackte Ware	R11
11.1.2	für verpackte Ware	R10
11.2	Warenannahme Fisch	R11
11.3	Bedienungsgang für Fleisch und Wurst	
11.3.1	für unverpackte Ware (z.B. lose in Transportboxen)	R11
11.3.2	für verpackte Ware	R10
11.4	Bedienungsgang für Brot und Backwaren, unverpackte Ware	R10
11.5	Bedienungsgang für Molkerei- und Feinkosterzeugnisse, unverpackte Ware	R10
11.6	Bedienungsgang für Fisch	
11.6.1	für unverpackte Ware	R12
11.6.2	für verpackte Ware	R11
11.7	Bedienungsgänge, ausgenommen Nr. 11.3 bis 11.6	R9
11.8	Fleischvorbereitungsraum	
11.8.1	zur Fleischbearbeitung, ausgenommen Nr. 5	R12 V8
11.8.2	zur Fleischverarbeitung, ausgenommen Nr. 5	R11
11.9	Blumenbinderäume und -bereiche	R11
11.10	Verkaufsbereiche mit Backöfen	
11.10.1	zum Herstellen von Backware	R11
11.10.2	zum Aufbacken vorgefertigter Backware	R10
11.11	Verkaufsbereiche mit Fritteusen oder Grillanlagen	R12
11.12	Verkaufsräume, Kundenräume	R9
11.13	Vorbereitungsbereiche für Lebensmittel zum SB-Verkauf (Ausgenommen Fleisch, Fisch und Wurst)	R10
11.14	Kassenbereiche, Packbereiche	R9
11.15	Verkaufsbereiche im Freien	R11 (oder R10 V4)

12 Räume des Gesundheitsdienstes/der Wohlfahrtspflege

12.1	Desinfektionsräume (nass)	R11
12.2	Vorreinigungsbereiche der Sterilisation	R10
12.3	Fäkalienräume, Ausgussräume, unreine Pflegearbeitsräume	R10
12.4	Sektionsräume	R10
12.5	Räume für medizinische Bäder, Hydrotherapie, Fango-Aufbereitung	R11
12.6	Waschräume von OP's, Gipsräume	R10
12.7	Sanitäre Räume, Stationsbäder	R10
12.8	Räume für medizinische Diagnostik und Therapie, Massageräume	R9
12.9	OP-Räume	R9
12.10	Stationen mit Krankenzimmern und Flure	R9
12.11	Praxen der Medizin, Tageskliniken	R9
12.12	Apotheken	R9
12.13	Laborräume	R9
12.14	Friseursalons	R9

13 Wäscherei

13.1	Räume mit Durchlaufwaschmaschinen (Waschröhren) oder mit Waschsleudermaschinen	R9
13.2	Räume mit Waschmaschinen, bei denen die Wäsche tropfnass entnommen wird	R11
13.3	Räume zum Bügeln und Mangeln	R9

14 Kraftfutterherstellung

14.1	Trockenfutterherstellung	R11
14.2	Kraftfutterherstellung unter Verwendung von Fett und Wasser	R11 V4

Alle Angaben ohne Gewähr. Gültigkeit zum Zeitpunkt der Drucklegung vorbehaltlich zwischenzeitlicher Änderungen.

15 Lederherstellung, Textilien	
15.1 Wasserwerkstatt in Gerbereien	R13
15.2 Räume mit Entfleischmaschinen	R13
V10	
15.3 Räume mit Leimlederanfall	R13
V10	
15.4 Fetträume für Dichtungsherstellung	R12
15.5 Färbereien für Textilien	R11
16 Lackierereien	
16.1 Nassschleifbereiche	R12
V10	
16.2 Pulverbeschichtung	R11
16.3 Lackierung	R10
17 Keramische Industrie	
17.1 Nassmühlen (Aufbereitung keramischer Rohstoffe)	R11
17.2 Mischer, Umgang mit Stoffen wie Teer, Pech, Graphit, Kunstharzen	R11 V6
17.3 Pressen (Formgebung), Umgang mit Stoffen wie Teer, Pech, Graphit, Kunstharzen	R11 V6
17.4 Gieß-, Druckgussbereiche	R12
17.5 Glasierbereiche	R12
18 Be- und Verarbeitung von Glas und Stein	
18.1 Steinsägerei, Steinschleiferei	R11
18.2 Glasformung von Hohlglas, Behälterglas	R11
18.3 Schleifereibereiche für Hohlglas, Flachglas	R11
18.4 Isolierglasfertigung, Umgang mit Trockenmittel	R11 V6
18.5 Verpackung, Versand von Flachglas, Umgang mit Antihafmittel	R11 V6
18.6 Ätz- und Säurepolieranlagen für Glas	R11
19 Betonwerke	
19.1 Betonwaschplätze	R11
20 Lagerbereiche	
20.1 Lagerräume für Öle und Fette	R12 V6
20.2 Lagerräume für verpackte Lebensmittel	R10
20.3 Lagerbereiche im Freien	R11 (oder R10 V4)
21 Chemische und thermische Behandlung von Eisen und Metall	
21.1 Beizereien	R12
21.2 Härtereien	R12
21.3 Laborräume	R11
22 Metallbe- und -verarbeitung, Metall-Werkstätten	
22.1 Galvanisierräume	R12
22.2 Graugussbearbeitung	R11 V4
22.3 Mechanische Bearbeitungsbereiche (z. B. Dreherei, Fräserei), Stanzerie, Presserei, Zieherei (Rohre, Drähte) und Bereiche mit erhöhter Öl-Schmiermittelbelastung	R11 V4
22.4 Mechanische Bearbeitungsbereiche	R11 V4
22.5 Teilreinigungsbereiche, Abdämpfbereiche	R12
23 Werkstätten für Fahrzeug-Instandhaltung	
23.1 Instandsetzungs- und Wartungsräume	R11
23.2 Arbeits- und Prüfgrube	R12 V4
23.3 Waschhalle, Waschplätze	R11 V4
24 Werkstätten für das Instandhalten von Luftfahrzeugen	
24.1 Flugzeughallen	R11
24.2 Werfthallen	R12
24.3 Waschplätze	R11 V4
25 Abwasserbehandlungsanlagen	
25.1 Pumpenräume	R12
25.2 Räume für Schlamm- und Schwebstoffabsetzanlagen	R12
25.3 Räume für Rechenanlagen	R12
25.4 Standplätze von Arbeitsplätzen, Arbeitsbühnen und Wartungspodeste	R12
26 Feuerwehrräume	
26.1 Fahrzeug-Stellplätze	R12
26.2 Räume für Schlauchpflegeeinrichtungen	R12
27 Funktionsräume in der Atemschutz Übungsanlage	
27.1 Vorbereitungsraum	R10
27.2 Konditionsraum	R10
27.3 Übungsraum	R11
27.4 Schleuse	R10
27.5 Zielraum	R11
27.6 Wärmegewöhnungsraum	R11
27.7 Leitstand	R9
28 Schulen und Kindertageseinrichtungen	
28.1 Eingangsbereiche, Flure, Pausenhallen	R9
28.2 Klassenräume, Gruppenräume	R9
28.3 Treppen	R9
28.4 Toiletten, Waschräume	R10
28.5 Lehrküchen in Schulen (siehe Nummer 9.2, 9.6 oder 9.7)	R10
28.6 Küchen in Kindertageseinrichtungen (siehe auch Nr. 9)	R10
28.7 Maschinenräume für Holzbearbeitung	R10
28.8 Fachräume für Werken	R10
28.9 Pausenhöfe	R11 (oder R10 V4)

29 Geldinstitute	
29.1 Schalterräume	R9
30 Betriebliche Verkehrswege in Außenbereichen	
30.1 Gehwege	R11 (oder R10 V4)
30.2 Laderampen	
30.2.1 überdacht	R11 (oder R10 V4)
30.2.2 nicht überdacht	R12 (oder R11 V4)
30.3 Schrägrampen (ab 3 % Steigung; z. B. für Rollstühle, Ladebrücken)	R12 (oder R11 V4)
30.4 Betankungsbereiche	
30.4.1 überdacht	R11
30.4.2 nicht überdacht	R12
31 Parkbereiche	
31.1 Garagen, Hoch- und Tiefgaragen ohne Witterungseinfluss****)	R10
31.2 Garagen, Hoch- und Tiefgaragen mit Witterungseinfluss	R11 (oder R10 V4)
31.3 Parkflächen im Freien	R11 (oder R10 V4)
32 Bäder	
32.1 Einzel- und Sammelumkleideräume	R10
32.2 Sauna- und Ruhebereiche	R10
32.3 Duschräume und Duschbereiche	R10
<i>NICHT von Agrob Buchtal empfohlen! Bitte R11 (in Kombination mit Bewertungsgruppe B) verwenden!</i>	
32.4 Beckenumgänge	R10
<i>NICHT von Agrob Buchtal empfohlen! Bitte R11 (in Kombination mit Bewertungsgruppe B) verwenden!</i>	

*) Für Fußböden in barfuß begangenen Nassbereichen siehe DGUV Information „Bodenbeläge für nassbelastete Barfußbereiche“ (DGUV Information 207-006)

**) Eingangsbereiche gemäß Nummer 0.1 sind die Bereiche, die durch Eingänge direkt aus dem Freien betreten werden und in die Feuchtigkeit von außen hereingetragen werden kann (siehe auch Abschnitt 6 Absatz 3, Verwendung von Schmutz- und Feuchtigkeitselementen). Für anschließende Bereiche oder andere großflächige Räume ist Abschnitt 4 Absatz 10 zu beachten.

***) Treppen, Rampen gemäß Nummer 0.3 und 0.5 sind diejenigen, auf die Feuchtigkeit von außen hineingetragen werden kann. Für anschließende Bereiche ist Abschnitt 4 Absatz 10 zu beachten.

****) Wurde überall ein einheitlicher Bodenbelag verlegt, kann der Verdrängungsraum aufgrund einer Gefährdungsbeurteilung (unter Berücksichtigung des Reinigungsverfahrens, der Arbeitsabläufe und des Anfalls an gleitfördernden Stoffen auf den Fußboden) bis auf V 4 gesenkt werden.

*****) Die Fußgängerbereiche, die nicht von Rutschgefahr durch Witterungseinflüsse, wie Schlagregen oder eingeschleppte Nässe, betroffen sind.

Fußböden in Räumen dürfen keine Unebenheiten, Vertiefungen, Stolperstellen oder gefährlichen Schrägen aufweisen. Sie müssen gegen Verrutschen bzw. Kippen (z. B. bei Abdeckungen) gesichert, tragfähig, trittsicher und rutschhemmend sein.

Fußböden sollen ohne Neigung angelegt werden. Außerhalb von dauerhaft eingerichteten Arbeitsplätzen sind davon funktionelle Neigungen ausgenommen, z. B. zur Ableitung von Flüssigkeiten oder zur Überbrückung von Höhenunterschieden, z. B. mit begehbaren Schrägrampen.

In Bereichen, die im Rahmen ihrer üblichen Nutzung durchgehend begangen werden müssen, dürfen sich die Fußbodenoberflächen hinsichtlich ihrer Rutschhemmung nicht so voneinander unterscheiden, dass es zu Stolper- und Rutschgefahren kommen kann.

Dies kann gegeben sein, wenn sich angrenzende Fußbodenoberflächen hinsichtlich der Rutschhemmung unterscheiden:

1. um mehr als eine R-Gruppe bei zwei angrenzenden Bereichen.
2. um mehr als zwei R-Gruppen, wenn der Übergang zu einer anderen Rutschhemmung deutlich erkennbar oder zu erwarten ist (z. B. bei Türdurchgängen oder -durchfahrten).

Bestehen aufgrund unterschiedlicher Rutschhemmungen Stolper- oder Rutschgefahren, sind geeignete Maßnahmen zu treffen, wie Übergangsbereiche, die in Laufrichtung mindestens 1,5 m lang sind.

Hinweis: Es wird empfohlen die Rutschhemmung eines Fußbodens innerhalb eines Arbeitsbereiches möglichst gleichmäßig zu gestalten, z. B. indem andere Oberflächenbeschaffenheiten innerhalb des Fußbodens, wie Abdeckungen, Markierungen oder aufgeklebte Folien, sich nicht um mehr als eine R-Gruppe voneinander unterscheiden.

Gebäudeeingänge sind so einzurichten, dass der Eintrag von Schmutz und Nässe nicht zu Rutschgefahren führt. Dazu eignet sich eine ausreichend große Überdachung über Gebäudeeingängen.

Innerhalb des Gebäudes kann dies durch Sauberlaufzonen in Form von Schmutz- und Feuchtigkeitselementen erreicht werden, die hinsichtlich ihrer Länge, Breite und des Materials auf den zu erwartenden Personenverkehr ausgelegt sind und in Laufrichtung über die gesamte Durchgangsbreite mindestens 1,5 m lang sind.

Sauberlaufzonen müssen gegen Verrutschen gesichert sein und dürfen keine Stolperstellen bilden, z. B. indem sie bündig mit dem unmittelbar daran anschließenden Bodenbelag abschließen. Sauberlaufzonen sind entsprechend ihrer Verschmutzung so zu reinigen oder auszutauschen, dass ihre Funktion erhalten bleibt.

Fußböden in Arbeitsräumen und -bereichen sind entsprechend der zu erwartenden betrieblichen Beanspruchung mit gleitfördernden Stoffen erforderlichenfalls mit der Möglichkeit einer Ableitung auszurüsten. Die angrenzenden Flächen zu Ablauföffnungen sowie Ablaufrinnen sollen ein Gefälle von mindestens 2 % haben, damit das Abfließen von fließfähigen Flüssigkeiten erleichtert wird. Diese Bereiche sind möglichst außerhalb von Verkehrswegen anzuordnen. Das Ableiten von Flüssigkeiten über Verkehrswege ist nach Möglichkeit zu vermeiden.

Fußbodenoberflächen von Bereichen, die in der Regel nass sind und barfuß begangen werden müssen, z. B. in Bädern, sowie Sanitärräumen, wie Wasch- und Umkleieräume, müssen so eingerichtet sein, dass sie sicher begangen werden können.

1.2. Barfußbereich

Zuständig: Deutsche Gesetzliche Unfallversicherung, Mittelstraße 51, 10117 Berlin-Mitte, Telefon: +49-30-28876-3800, Fax: -3808, www.dguv.de, info@dguv.de, www.unfallkassen.de.

Böden in nassbelasteten Barfußbereichen, z. B. in Bädern, Krankenhäusern sowie Umkleide-, Wasch- und Duschräumen von Sport- und Arbeitsstätten.

Prüfnorm: DIN EN 16165.

Merkblatt: DGVU-Information 207-006 „Bodenbeläge für nassbelastete Barfußbereiche“. (bisherige GUV-I 8527)

Prüfverfahren: Schiefe Ebene, Begehung barfuß, Gleitmedium Netzmittellösung.

Die Oberflächen sind eben, mikrorauh oder mäßig profiliert. Non-Slip-Glasuren mit ihren mikrorauen Oberflächen haben sich hervorragend bewährt.

Den Bewertungsgruppen sind die jeweiligen Bereiche zugeordnet. Die Deutsche Gesetzliche Unfallversicherung und Agrob Buchtal geben Auskunft.

Bewertungsgruppe A

- Barfußgänge und Sanitärbereiche (weitgehend trocken)
- Einzel- und Sammelumkleideräume
- Beckenböden in Nichtschwimmerbereichen, wenn im gesamten Bereich die Wassertiefe mehr als 80 cm beträgt
- Sauna-, Ruhebereiche (weitgehend trocken)

Bewertungsgruppe B



- Barfußgänge und Sanitärbereiche, soweit sie nicht A zugeordnet sind
- Duschräume und Duschbereiche
- Dampfbäder
- Bereich von Desinfektionssprühanlagen
- Beckenumgänge
- Beckenböden in Nichtschwimmerbereichen, wenn in Teilbereichen die Wassertiefe weniger als 80 cm beträgt
- Beckenböden in Nichtschwimmerbereichen von Wellenbecken
- Hubböden
- Planschbecken
- Leitern und Treppen außerhalb des Beckenbereiches, soweit sie nicht C zugeordnet sind
- begehbare Oberflächen von Sprungplattformen und Sprungbrettanlagen, soweit sie nicht C zugeordnet sind
- Sauna- und Ruhebereiche, soweit sie nicht A zugeordnet sind

Bewertungsgruppe C

- Ins Wasser führende Leitern und Treppen
- Aufgänge zu Sprunganlagen und Wasserrutschen
- Oberflächen von Sprungplattformen und Sprungbrettern in der Länge, die für den Springer reserviert ist (Die rutschfeste Oberfläche der Sprungplattformen und Sprungbretter muss um die Vorderkante herumgeführt werden, wo die Hände und Zehen der Benutzer greifen)
- Durchschreitebecken
- Geneigte Beckenrandausbildung
- Kneippbecken, Tretbecken
- Rampen im Beckenumgangsbereich mit Neigung > 6%
- Startblöcke

Begehbare Sitzflächen, wie z. B. Tribünen und Podeste in Beckennähe, in die Nässe verschleppt werden kann, sind wie Bodenbelagsflächen zu behandeln. Werden Barfußbereiche planmäßig auch mit Schuhwerk begangen, sind zusätzlich die Anforderungen nach der ASR A1.5/1,2 zu beachten.

Test auf „Schiefer Ebene“

Bewertungs-Gruppen	Neigungswinkel	Barfußbereich
A	≥12°	
B	≥18°	
C	≥24°	

Die angegebenen Neigungswinkel dienen ausschließlich zur Zuordnung der Bewertungsgruppen und sind nicht mit den Neigungswinkeln von Schrägen/Rampen gleichzusetzen.

Alle Angaben sowie Zitate aus Produkt- und Prüfnormen sind als unverbindliche Hinweise zu betrachten. Es gelten die jeweils aktuellsten Fassungen.

1.3. Gleitreibungsmessung

Zuständig: Deutsche Gesetzliche Unfallversicherung,
Mittelstraße 51, 10117 Berlin-Mitte, Telefon:

+49-30-28876-3800, Fax: -3808,

www.dguv.de, info@dguv.de, www.unfallkassen.de.

Prüfnorm: DIN 51131

Merkblatt: DGUV-Information 208-041 „Bewertung der Rutschgefahr unter Betriebsbedingungen“ (bisherige GUV-I 8687)

Diese Prüfung ist keine Baumusterprüfung und kann somit weder zur Auswahl von Bodenbelägen im Planungsstadium noch zu einer Eingruppierung in eine Bewertungsklasse der Rutschhemmung herangezogen werden. Das Verfahren kann z. B. zur Beurteilung des Erfolgs von Reinigungsmaßnahmen oder bei geplanten Nutzungsänderungen angewendet werden.

Für die Auswahl eines Bodenbelags sind ausschließlich DGUV-Regel 108-003 (bisherige BGR 181) bzw. DGUV-Information 207-006 (bisherige GUV-I 8527) anzuwenden!

1.4. Privatbereich

Hinsichtlich der Trittsicherheit unterliegen keramische Bodenbelagsflächen im Privatbereich keinen geregelten Vorgaben. Unabhängig davon, empfiehlt es sich, je nach persönlichem Sicherheitsbedürfnis, trittsichere Fliesen zu wählen.

Color Shade Variation

„Color shade variation“ beschreibt die farbliche Änderung zwischen den Fliesen einer Farbstellung, d.h. den Abtönungsgrad. Die Einstufung unserer Produkte erfolgt in 4 Abtönungskoeffizienten:

V0 = Keine Variation / Kein Farbspiel
V1 = Geringe Variation / geringes Farbspiel
V2 = Mittlere Variation / mittleres Farbspiel
V3 = Hohe Variation / hohes Farbspiel
V4 = Starke Variation / starkes Farbspiel

Rückseitig thermoplastische Mosaik-Verklebung: Auch bei Nässe dauerhaft sicher

Die thermoplastische Verklebung von Mosaiken der Marken Agrob Buchtal und Jasba ist auch für den Dauernass- und Unterwasserbereich bestens geeignet. Untersuchungen durch unabhängige Institute haben bestätigt, dass es unter üblichen hygienischen Bedingungen zu keinem mikrobiologischen Befall am Glasfasernetz kommt. Das Verbundverhalten nach Trocken- und Nasslagerung liegt mit den Werten $>0,5\text{N/mm}^2$ oberhalb der nach DIN EN 12004 geforderten Werte. Damit empfiehlt sich die rückseitige thermoplastische Verklebung nicht nur für Trockenbereiche, sondern auch für Unterwasserbereiche (Schwimmbecken

und Whirlpools) sowie für dauernassbelastete Bereiche wie Duschen und Beckenumgänge. Außerdem ist die rückseitige Verklebung verlegefreundlicher und sorgt für deutliche Zeitersparnis gegenüber der bisher notwendigen vorderseitigen Folie. So verhindert das rückseitige Glasfasernetz weitgehend das Eindringen von Fliesenkleber in die Fugen. Das zeitaufwändige Entfernen der Folie und etwaiger Rückstände auf der Fliesenoberfläche entfällt. Die Auskleidung von Säulen und Rundungen wird entscheidend vereinfacht.

Anschriftenliste

Bundesanstalt für Arbeitsschutz und Arbeitsmedizin (BAuA)

Friedrich-Henkel-Weg 1-25, 44149 Dortmund
 Telefon: +49-231-9071-0, Fax: -2454,
 www.baua.de, poststelle@baua.bund.de

DGUV-Regelwerke (BG/GUV)

Deutsche Gesetzliche Unfallversicherung
 Mittelstraße 51, 10117 Berlin-Mitte,
 Telefon: +49-30-28876-3800, Fax: -3808,
 www.dguv.de, info@dguv.de

DIN/EN/ISO Normenblätter

Deutsches Institut für Normung e.V., 10772 Berlin
 Telefon: +49-30-2601-0, Fax: -60,
 www.din.de, info@din.de,
 Bezugsquelle:
 Beuth Verlag GmbH, Burggrafenstraße 6,
 10787 Berlin, Telefon: +49-30-2601-2201-0, Fax: -1260,
 www.beuth.de, info@beuth.de

KOK-Richtlinien für den Bäderbau

RK-Liste geprüfter Reinigungsmittel DGfdB-Regelwerke

Deutsche Gesellschaft für das Badewesen e.V.,
 45130 Essen
 Telefon: +49-201-87969-0, Fax: -20,
 www.baederportal.com, info@baederportal.com
 Bezugsquelle: Direktbezug beim Herausgeber

Bundesverband Keramische Fliesen e. V.

Luisenstraße 44, 10177 Berlin
 Telefon: 030/27 59 59 74-0, Fax: -99
 www.fliesenverband.de, info@fliesenverband.de

ZDB-Merkblätter

Fachverband Fliesen und Naturstein im Zentralverband des Deutschen Baugewerbes

Kronenstr. 55-58, 10117 Berlin-Mitte,
 Telefon: +49-30-20314-0, Fax: -419,
 www.fachverbandfliesen.de, info@fachverband-fliesen.de

Bezugsquelle:

Verlagsgesellschaft Rudolf Müller GmbH & CoKG,
 Stolberger Straße 84, 50933 Köln
 Postfach: 410949, 50869 Köln
 Telefon: +49-221-5497-112, Fax: -6112
 www.baufachmedien.de, service@rudolf-mueller.de

Güteprüfungen

Güteprüfungen erfolgen durch:

- Eigenprüfung der produzierenden Werke mit strenger Sortierung
- Kontroll- und Sonderprüfungen der Deutsche Steinzeug Labore
- Einzel- und Serienprüfungen durch externe Materialprüfanstalten im In- und Ausland

Zeugnisse

Unsere Produkte werden in anerkannten Materialprüfungsämtern hinsichtlich der Eigenschaften und der Qualität ständig geprüft. Entsprechende Prüfungszeugnisse liegen vor.



* Eine Übersicht der zertifizierten Einzelprodukte stellen wir Ihnen auf Anfrage gerne zur Verfügung.

Duschtassensystem Area Pro/Plural non-slip/Plural unglasiert/Basis 3

Das Duschtassensystem besteht aus Formstückfliesen zur Erstellung einer in den Fliesenbelag integrierten Duschtasse.

Das Duschtassensystem ist mit Gebrauchsmusterschutz versehen. Es entspricht den Vorgaben der DIN 18040 Barrierefreies Bauen und DIN 18025 Barrierefreies Wohnen.

Die Schwallkante von 10 mm erlaubt eine uneingeschränkte Inanspruchnahme verschiedener Wohnungsbauförderungsbestimmungen.

Das Modulmaß von 100 mm inkl. einer 3 mm-Fuge garantiert hygienisch einwandfreie Fliesenbeläge mit schmaler Fugenbreite und maßhaltigen Fliesen.

Wie alle Trittsicherheitsoberflächen von Plural non-slip/Plural unglasiert, der Serie Basis 3 sind sowohl die glasierten als auch die keramisch vergüteten, unglasierten Fliesenoberflächen sehr leicht zu reinigen.

Das Duschtassensystem ist prädestiniert für Nasszellen in Krankenhäusern, Sanatorien, Reha-zentren, Alten- und Pflegeheimen, aber auch für gewerbliche Reihenduschen, Schwimmbad-, Sauna- und Sportanlagen, Hotel- und Privatbäder.

1. Die Duschtasse ist beliebig in den Fliesenbelag integrierbar und ermöglicht modular im Fugenraster das erforderliche Gefälle.

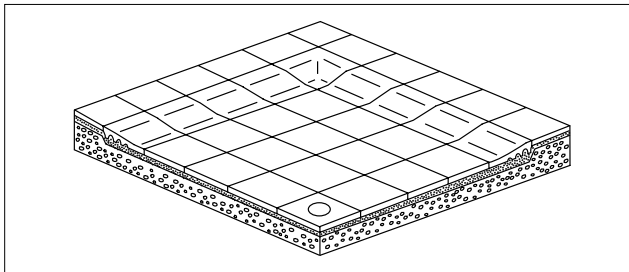

2. In Kombination mit dem flach liegenden Hohlkehlssockel ist ein gerundeter Übergang vom Boden- zum Wandbelag möglich.

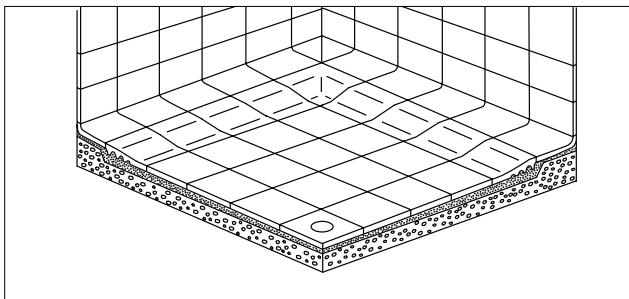

Area Pro, Plural non-slip, Plural unglasiert

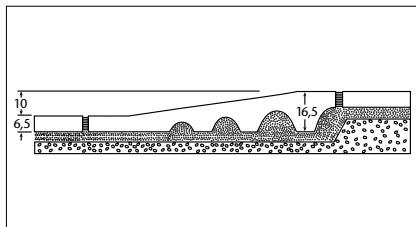
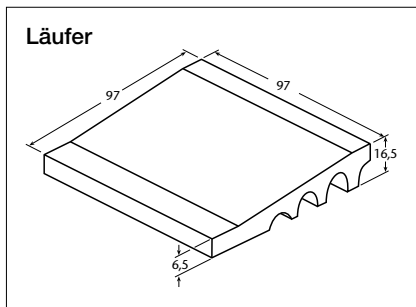
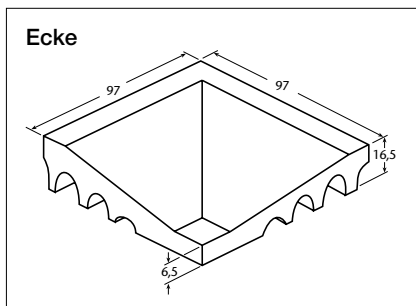

Basis 3 Softcorn

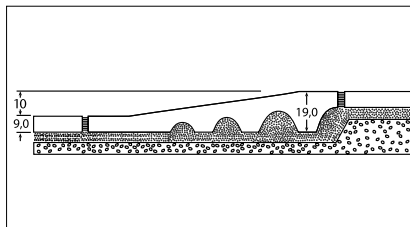
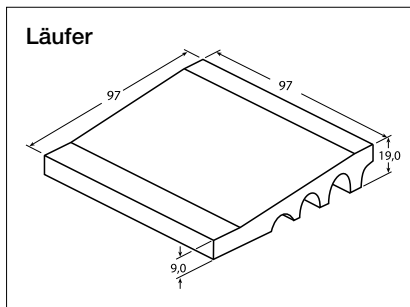
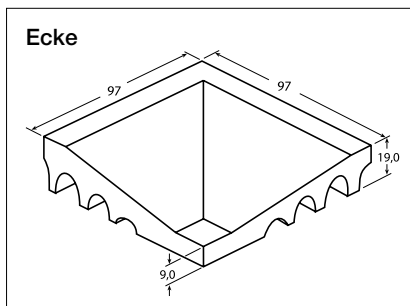

Alle Angaben sowie Zitate aus Produkt- und Prüfnormen sind als unverbindliche Hinweise zu betrachten. Es gelten die jeweils aktuellsten Fassungen.

Duschtassensystem der Serien Chroma / Chroma unglasiert – Quantum

Dieses Duschtassensystem besteht aus nur zwei Komponenten: Dem Läufer und der dazu gehörigen einteiligen Ecke.

Eine Besonderheit ist die spezielle Form der Absenkung, die eine Höhendifferenz von 10 mm aufweist. Der so gestaltete Duschtassenrand ist leicht zu begehen bzw. problemlos mit dem Rollstuhl zu befahren. Die einschlägigen Forderungen (DIN 18040 bzw. 18025) in Bezug auf das barrierefreie, Senioren- und behindertengerechte Bauen werden somit wirkungsvoll unterstützt.

Durch die „eingebaute Schräge“ muss der Duschtassenrand nicht mehr mühsam örtlich ausgebildet werden, und in Verbindung mit der verlegefreundlichen Unterseite ist die Verarbeitung daher denkbar einfach:

Das Duschtassensystem wird perfekt ergänzt durch die Serien Chroma / Chroma unglasiert – Quantum.

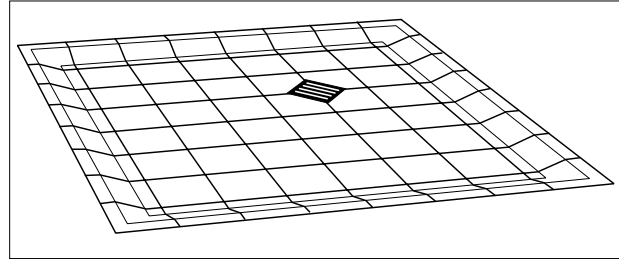

Das Duschtassensystem basiert auf einem Rastermaß von 12,5 x 12,5 cm. Dies erlaubt eine sehr variable, von Standardabmessungen unabhängige Dimensionierung der Duschtasse und eine harmonische Integration in die Duschanlage bzw. Nasszelle.

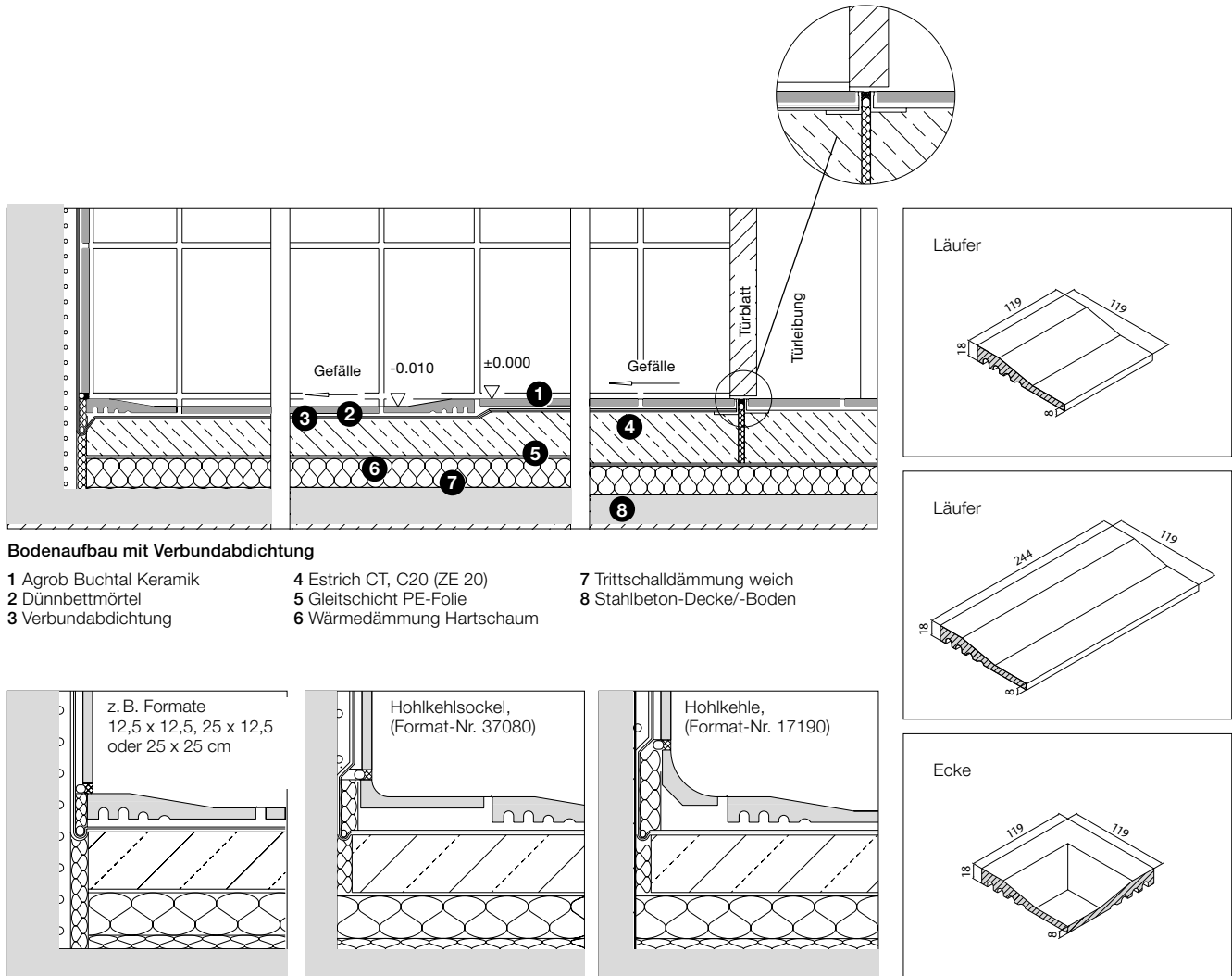

Wandanschlussvarianten

Die Duschtassensysteme von Agrob Buchtal werden auf einem durchgehenden Zementestrich verlegt und haben somit keine wartungsaufwändige Bewegungsfuge zwischen Duschtasse und anschließenden Flächen.

Alle Angaben sowie Zitate aus Produkt- und Prüfnormen sind als unverbindliche Hinweise zu betrachten. Es gelten die jeweils aktuellsten Fassungen.

Hohlkehlsockel

Hohlkehlsockel 10 x 10 cm

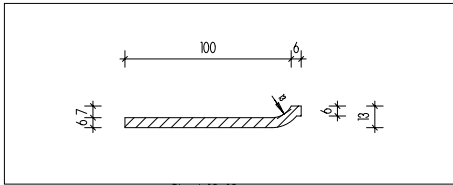

Passend zu:

Area Pro, eben, 10 x 10 cm, unglasiert
Plural/Plural non-slip, eben und trittsicher, 10 x 10 cm
Basis 2, eben, 10 x 10 cm, glasiert
Basis 3, eben, 10 x 10 cm, unglasiert
Plural unglasiert, eben, 10 x 10 cm

Hohlkehlsockel 10 x 15, 10 x 20, 10 x 30 und 10 x 60 cm

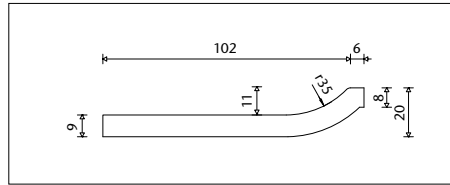

Passend zu:

Emotion GRIP, eben oder Softcorn, 10 x 20, 10 x 30 cm, unglasiert
Basis 3, eben, 10 x 15, 10 x 20 cm, unglasiert
Basis Pro, eben, 10 x 30 cm, unglasiert
Area Pro, eben, 10 x 20, 10 x 30 und 10 x 60 cm, unglasiert

Hohlkehlsockel 10 x 25, 10 x 50 und 10 x 60 cm

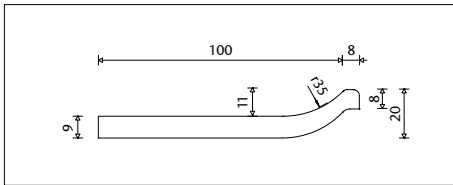

Passend zu:

Ascona, strukturiert, 10 x 25, 10 x 50, 10 x 60 cm, glasiert
Nova, eben, 10 x 60 cm, glasiert
Quarzit, strukturiert, 10 x 60 cm, glasiert

Hohlkehlsockel 12,5 x 25 cm

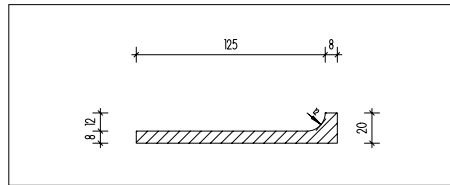

Passend zu:

Chroma unglasiert, eben, 12,5 x 25 cm, unglasiert

Hohlkehlsockel 12,5 x 25 cm

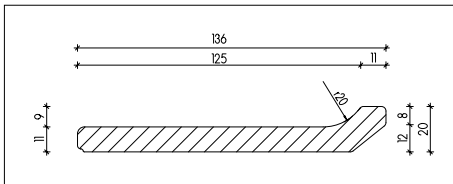

Passend zu:

Ferrum, eben, 12,5 x 25 cm, unglasiert

Innenecke

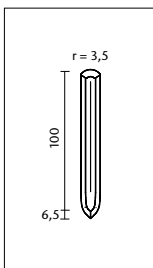

Passend zu
Hohlkehlsockel:

Plural non-slip,
10 x 10 cm, glasiert

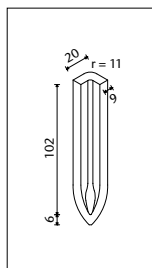

Passend zu
Hohlkehlsockel:

Area Pro,
10 x 10, 10 x 20, 10 x 30,
10 x 60 cm, unglasiert

Emotion GRIP,
10 x 20 und 10 x 30 cm, unglasiert

Basis 3,
10 x 20 cm, unglasiert

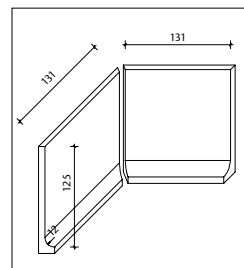

Passend zu
Hohlkehlsockel:

Chroma unglasiert,
12,5 x 25 cm, unglasiert

Außenecke

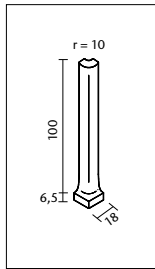

Passend zu
Hohlkehlsockel:

Plural non-slip,
10 x 10 cm, glasiert

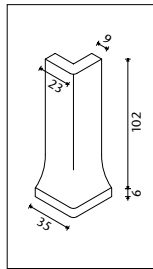

Passend zu
Hohlkehlsockel:

Area Pro,
10 x 10, 10 x 20, 10 x 30,
10 x 60 cm, unglasiert

Emotion GRIP,
10 x 20 und 10 x 30 cm,
unglasiert

Basis 3,
10 x 20 cm, unglasiert

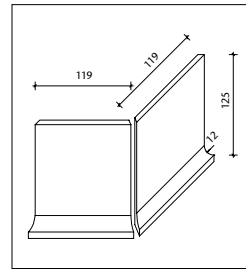

Passend zu
Hohlkehlsockel:

Chroma unglasiert,
12,5 x 25 cm, unglasiert

Hohlkehlsockel, geschnitten/verklebt 15 x 60 cm bzw. Innenecken 15 x 15 cm

Details: Können aus beliebigen Fliesen/Platten gefertigt werden. Optik und Haptik analog der umgebenden Fläche, d.h. sowohl Struktur als auch Farbgleichheit werden gewährleistet. Mindestbestellmenge Sockel: 50 Stück; Ecke: 50 Stück

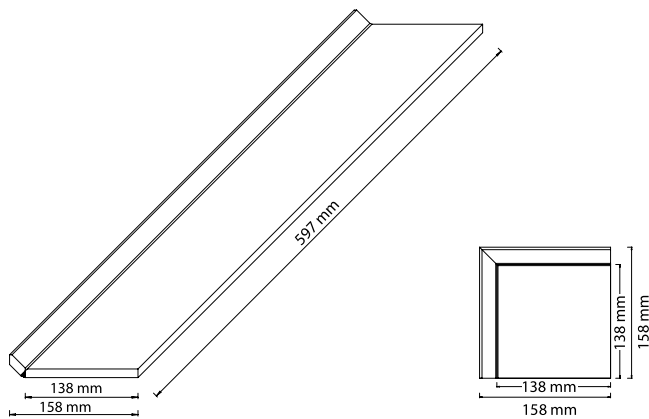

Hohlkehlsockel

Ecke

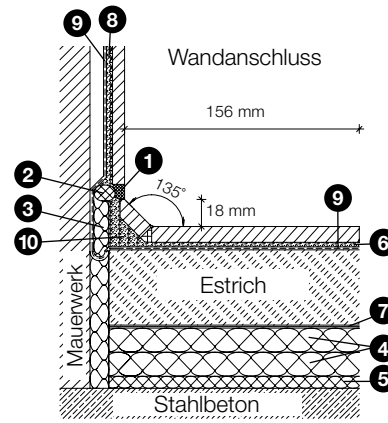

Maßstab 1:5

- 1 UW Silikon
- 2 Geschlossenzellige PE-Schaumstoffrundschnur bzw. Trennfolie
- 3 Wasserbeständiges, elastisches Füllmaterial
- 4 Wärmedämmung Hartschaum
- 5 Trittschalldämmung weich
- 6 Mörtel / Kleber
- 7 Gleitschicht PE-Folie
- 8 Dünnbetverlegung aus Zementputz
- 9 Abdichtung im Verbund
- 10 Vollsatte Hinterfüllung

Treppenkanten / Treppenfliesen

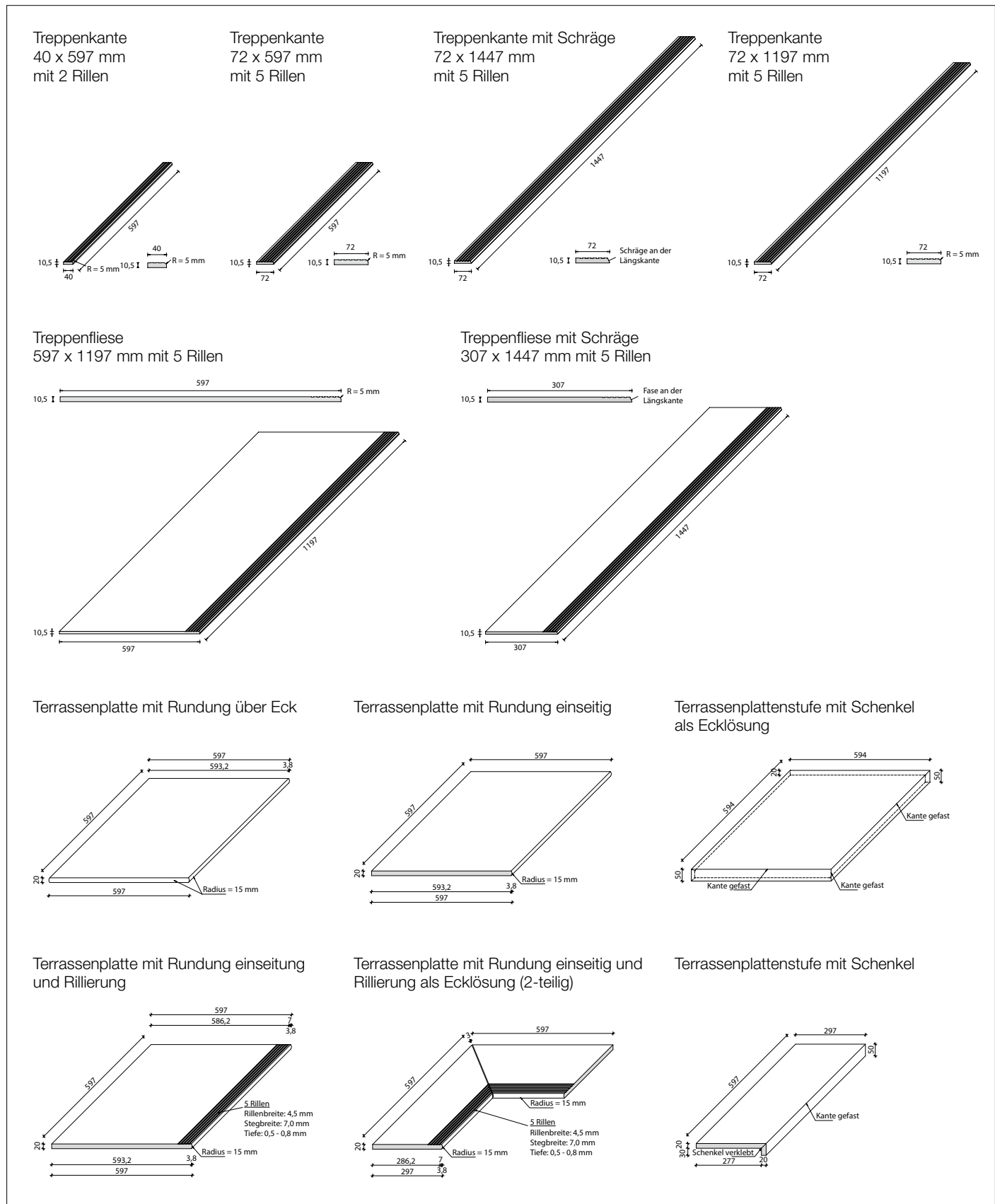

1. Bauprodukteverordnung (BauPVO)

Die BauPVO unterscheidet sich insbesondere durch die Leistungserklärung, die CE-Kennzeichnung und die Bewertung und Überprüfung der Leistungsbeständigkeit von der bisherigen Bauprodukterichtlinie (BPR).

Bauprodukte, die nach dem 01. Juli 2013 in Verkehr gebracht werden, müssen der BauPVO entsprechen. Unter „Inverkehrbringen“ ist die erstmalige Verfügbarkeitsmachung eines Bauprodukts auf dem europäischen Markt durch den Hersteller zu verstehen.

Wir weisen darauf hin, dass der Begriff der „Bereitstellung“ davon abgegrenzt ist, welcher die Weitergabe eines in Verkehr gebrachten Bauprodukts in der Lieferkette bezeichnet z. B. vom Fliesenfachhandel an den Endkunden.

Wesentliche Merkmale eines Bauprodukts, hier keramische Fliesen und Platten, sind im Anhang ZA der harmonisierten Norm DIN EN 14411 festgelegt.

2. CE-Kennzeichnung

Der Hersteller dokumentiert damit, dass er die Verantwortung für die Übereinstimmung des Bauprodukts mit der in der Leistungserklärung angegebenen Leistung sowie die Einhaltung aller einschlägigen europäischen Rechtsvorschriften übernimmt.

Weiterhin ist er dafür verantwortlich, dass das CE-Kennzeichen auf dem Bauprodukt selbst, einem Etikett oder auf der Verpackung angebracht ist. Das CE-Kennzeichen ist das alleinige Übereinstimmungskennzeichen für alle wesentlichen Merkmale eines Bauprodukts. Lediglich für Aspekte, die in unserem Fall nicht von der DIN EN 14411 geregelt werden, dürfen zusätzliche Zeichen eingesetzt werden.

3. Leistungserklärung

Seit 01. Juli 2013 ist jeder Hersteller verpflichtet für jedes seiner Bauprodukte eine Leistungserklärung zu erstellen. Damit übernimmt er die Verantwortung für die Übereinstimmung des Bauprodukts mit den erklärten Leistungen. Die Leistungserklärung löst die bisherige Konformitätserklärung ab.

Grundlage für die Leistungserklärung bildet die technische Dokumentation des Herstellers. Hierzu zählen u. a. die Ergebnisse der werkseigenen Produktionskontrollen wie z. B. Erstprüfungen.

Die Leistungserklärung ist mit einer vom Hersteller frei wählbaren Referenznummer zu versehen, auf die im Rahmen der CE-Kennzeichnung Bezug genommen wird und damit eine eindeutige Identifikation des Bauprodukts ermöglicht.

Die Leistungserklärung kann in gedruckter oder in elektronischer Form (z. B. Mail, CD oder USB Stick) bereitgestellt werden.

Weiterhin können die Leistungserklärungen für die Bauprodukte der Agrob Buchtal Solar Ceramics GmbH unter www.agrob-buchtal.de/leistungserklaerung eingesehen werden. Scannen Sie alternativ diesen QR-Code:







Architekten + Planer Deutschland

Verkaufsgebiet	PLZ-Gebiet	Gebietsleitung	E-Mail	mobil
0001	17 (ohne 17268, 17279, 17291), 18, 19, 20, 21 (ohne 21244-21272, 21614-21799), 22, 23, 24, 25	Stephan Rüttel	Stephan.Ruettel@deutsche-steinzeug.de	0171/4773605
0002	21244-21272, 21614-21799, 26, 27, 28, 29, 31582, 31592, 31595, 31600- 31638, 49 (ohne 49074-49328, 49477-49549, 49808-49849)	Jochen Prinz	Jochen.Prinz@deutsche-steinzeug.de	0171/5669993
0003	06700-06799, 06800-06899, 10, 12, 13, 14, 15, 16, 17268, 17279, 17291, 39524-39539, 39576-39599, 39606-39615, 39624-39629	Thomas Bischoff	Thomas.Bischoff@deutsche-steinzeug.de	0170/5618977
0004	30, 31 (ohne 31582, 31592, 31595, 31600- 31638), 37154-37199, 37412- 37431, 37441-37649	Sven Müller	Sven.Mueller@deutsche-steinzeug.de	0171/5669994
0005	39 (ohne 39524-39539, 39576-39599, 39606-39615, 39624-39629)	Sven Müller	Sven.Mueller@deutsche-steinzeug.de	0171/5669994
0006	32, 33, 44 (ohne 44629), 57 (ohne 57520, 57567, 57583, 57627, 57629, 57642), 58, 59 (ohne 59330-59399)	Janina Schwarz	Janina.Schwarz@deutsche-steinzeug.de	0171/5669988
0006	44629, 45600-45799, 46325, 46348, 46359, 46395-46399, 46414, 46419, 46459, 46487, 46499, 48, 49074-49328, 49477-49549, 49808-49849	Alfons Seggewiss	Alfons.Seggewiss@deutsche-steinzeug.de	0160/5898429
0007	40, 41, 42, 45 (ohne 45600-45799), 46 (ohne 46325, 46348, 46359, 46395-46399, 46414, 46419, 46459, 46487, 46499), 47, 50, 51, 52, 53, 57520, 57567, 57583, 57627, 57629, 57642	Harald Baumann	Harald.Baumann@deutsche-steinzeug.de	0171/9708365
0008	06 (ohne 06700-06799, 06800-06899), 34, 35, 36, 37 (ohne 37154-37199, 37412-37431, 37441-37649), 38835-38899, 60, 61, 63, 98527-98639, 99610-99638, 99706-99768, 99817-99848, 99947-99998	Sven Müller	Sven.Mueller@deutsche-steinzeug.de	0171/5669994
0009	54, 55, 56, 64, 65, 66, 67, 68, 69	Martin Schwab	Martin.Schwab@deutsche-steinzeug.de	0171/5669991
0010	90, 91, 92, 95, 96, 97	Markus Dörfler	Markus.Doerfler@deutsche-steinzeug.de	0170/9107373
0011	01, 02, 03, 04, 07, 08, 09, 98646-98746, 99000-99518, 99867-99898	Jonas Wünsche	Jonas.Wuensche@deutsche-steinzeug.de	0171/2254226
0012	70, 71, 75172-75181	Michael Stoll	Michael.Stoll@deutsche-steinzeug.de	0151/14823489
0012	72, 73, 74, 75 (ohne 75172-75181), 76, 77, 78, 79, 87, 88, 89	Thomas Hüttner	Thomas.Huettner@deutsche-steinzeug.de	0151/12013231
0013	83000-83599, 84, 85000-85139, 86600-86759, 93, 94	Martin Schart	Martin.Schart@deutsche-steinzeug.de	0171/7648319
0013	80, 81, 82, 83600-83737, 85 (ohne 85001-85139), 86 (ohne 86600-86759)	Florian Nößner	Florian.Noessner@deutsche-steinzeug.de	0170/5629482

Handel + Handwerk Deutschland

Verkaufsgebiet	PLZ-Gebiet	Gebietsleitung	E-Mail	mobil
0001	17 (ohne 17268, 17279, 17291), 18, 19, 20, 21 (ohne 21244-21272, 21614-21799), 22, 23, 24, 25	Dirk Belder	Dirk.Belder@deutsche-steinzeug.de	0171/9967208
0002	21244-21272, 21614-21799, 26, 27, 28, 29, 31582, 31592, 31595, 31600- 31638, 49 (ohne 49074-49090, 49324-49398, 49477-49479, 49808-49811)	Dirk Belder	Dirk.Belder@deutsche-steinzeug.de	0171/9967208
0003	06700-06799, 06800-06899, 10, 12, 13, 14, 15, 16, 17268, 17279, 17291, 39524-39539, 39576-39599, 39606-39615, 39624-39629	Thomas Bischoff	Thomas.Bischoff@deutsche-steinzeug.de	0170/5618977
0004	30, 31 (ohne 31582, 31592, 31595, 31600- 31638), 37154-37199, 37412- 37431, 37441-37649,	Dirk Belder	Dirk.Belder@deutsche-steinzeug.de	0171/9967208
0005	39 (ohne 39524-39539, 39576-39599, 39606-39615, 39624-39629)	Sven Müller	Sven.Mueller@deutsche-steinzeug.de	0171/5669994
0006	32, 33, 44 (ohne 44629), 57 (ohne 57520, 57567, 57583, 57627, 57629, 57642), 58, 59 (ohne 59330-59399)	Janina Schwarz	Janina.Schwarz@deutsche-steinzeug.de	0171/5669988
0006	44629, 45600-45799, 46325, 46348, 46359, 46395-46399, 46414, 46419, 46459, 46487, 46499, 48, 49074-49090, 49324-49398, 49477-49479, 49808-49811, 59330-59399	Alfons Seggewiss	Alfons.Seggewiss@deutsche-steinzeug.de	0160/5898429
0007	40, 41, 42, 45 (ohne 45600-45799), 46 (ohne 46325, 46348, 46359, 46395-46399, 46414, 46419, 46459, 46487, 46499), 47, 50, 51, 52, 53, 57520, 57567, 57583, 57627, 57629, 57642	Michael Andries	Michael.Andries@deutsche-steinzeug.de	0171/8610267
0008	06 (ohne 06700-06799, 06800-06899), 34, 35, 36, 37 (ohne 37154-37199, 37412-37431, 37441-37649), 38835-38899, 60, 61, 63, 98527-98639, 99610-99638, 99706-99768, 99817-99848, 99947-99998	Andreas Strickrodt	Andreas.Strickrodt@deutsche-steinzeug.de	0171/5402801
0009	54, 55, 56, 64, 65, 66, 67, 68, 69	Martin Schwab	Martin.Schwab@deutsche-steinzeug.de	0171/5669991
0010	90, 91, 92, 95, 96, 97	Frank Lohre	Frank.Lohre@deutsche-steinzeug.de	0171/5661429
0011	01, 02, 03, 04, 07, 08, 09, 98646-98746, 99000-99518, 99867-99898	Jonas Wünsche	Jonas.Wuensche@deutsche-steinzeug.de	0171/2254226
0012	70, 71, 72, 73, 74, 75, 76, 77, 78, 79, 87, 88, 89	Michael Stoll	Michael.Stoll@deutsche-steinzeug.de	0151/14823489
0013	83000-83599, 84, 94	Martin Schart	Martin.Schart@deutsche-steinzeug.de	0171/7648319
0013	80, 81, 82, 83600-83737, 85, 86, 93	Florian Nößner	Florian.Noessner@deutsche-steinzeug.de	0170/5629482



Österreich

Österreich, Burgenland, Oberösterreich, Steiermark	Robert Wölfler	Robert.Woelfler@deutsche-steinzeug.de	+43 664/1342659
Tirol, Vorarlberg, Salzburg, Kärnten	Erwin Bauer	Erwin.Bauer@deutsche-steinzeug.de	+43 664/1153558
Wien, Niederösterreich	Thomas Höppner	Thomas.Hoepfner@deutsche-steinzeug.de	+43 664 1543635

Schweiz

Deutsche Steinzeug Schweiz AG,
Oberstmühle 3, 6370 Stans/NW
info@deutsche-steinzeug.ch
+4141/6325060



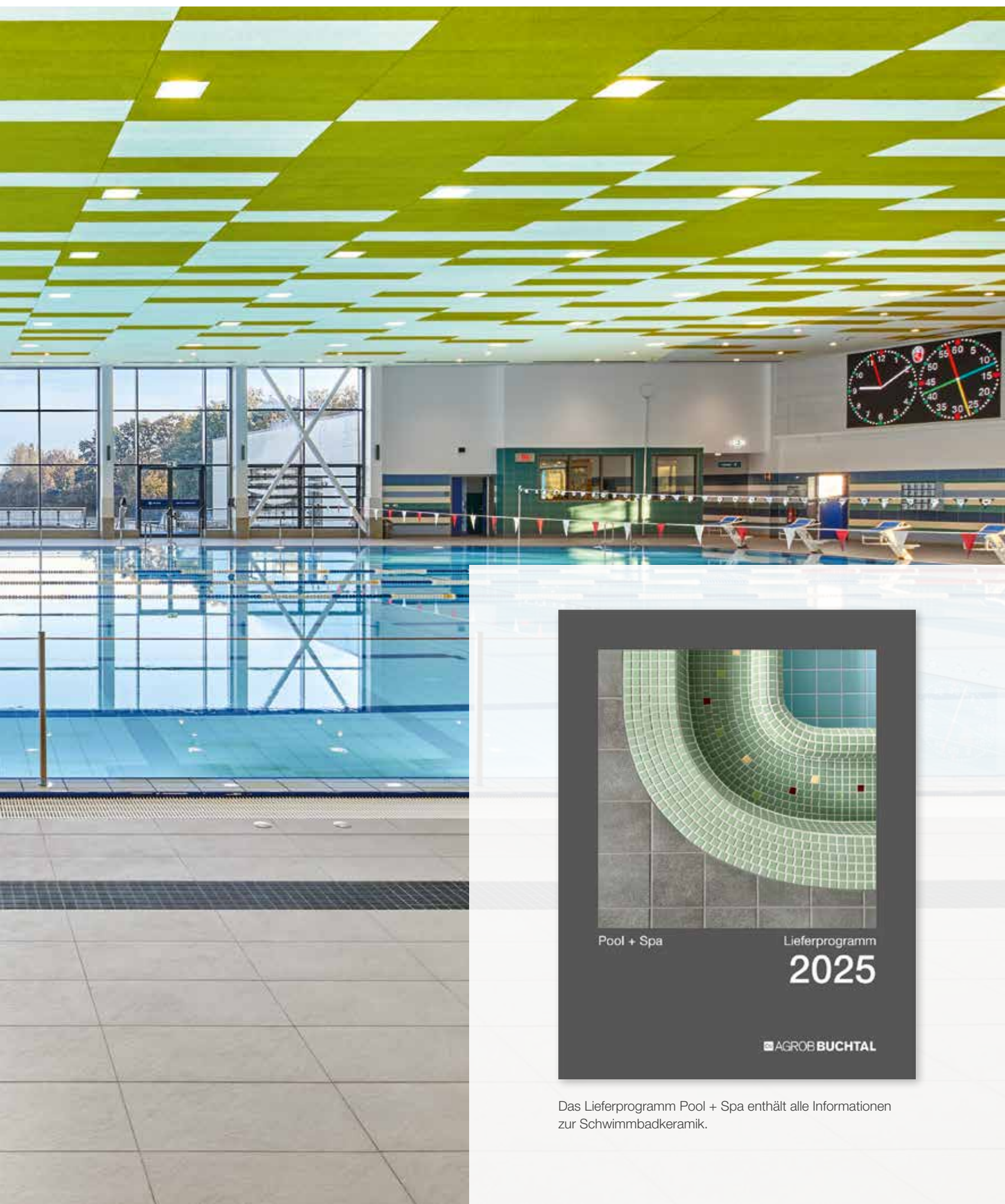

Pool + Spa

Lieferprogramm

2025

AGROB **BUCHTAL**

Das Lieferprogramm Pool + Spa enthält alle Informationen zur Schwimmbadkeramik.

Einfach zu finden

Die einzelnen Serien werden jeweils in folgender Form dargestellt:

- Farbübersicht
- Kurzbeschreibung
- Produktdaten

- 1 **Serienname**; daneben Materialart (siehe Seite 521) und maßgebliche Produktnorm (siehe Seite 523)
- 2 **Ordnungsschema der Formate** von links nach rechts: Flächenformate von klein nach groß bei Spalt- und Steinzeugplatten rechteckige, dann quadratische Formate von klein nach groß Formteile / Formstücke

3 **Besonderheiten** des Formats

4 **Formatnummer** (nur bei Spalt- und Steinzeugplatten)

5 **Nennmaß** = Herstellmaß + empfohlene Fugenbreite in Zentimeter und Inch
Herstellmaß = reines Materialmaß ohne Fuge

6 **Oberflächenbeschaffenheit**

7 **Logistische Produktdaten**

8 **Produktnorm**

9 **Trittsicherheitseinstufung**: Barfußbereich/öffentlich-gewerblicher Bereich (siehe Seiten 11 und 528 ff)

10 **Belastungsgruppe 1 – 5**; Orientierungshilfe für den Industrie- und Gewerbebereich (siehe Seite 524 ff)

11 **Artikelnummer**

12 **Abriebverhalten** bei glasiertem Material nach Beanspruchungsgruppen 1-5; (siehe Seite 525).

13 **Farbbezeichnung** und/oder Farbnummer

14 **Preisgruppe** (in Klammern Berechnungseinheit)

15 **Color Shade Variation** („Color Shade Variation“ beschreibt die farbliche Änderung zwischen den Fliesen einer Farbstellung, d. h. den Abtönungsgrad. Die Einstufung unserer Produkte erfolgt in 5 Abtönungskoeffizienten.)

- V0** Keine Variation / kein Farbspiel
- V1** Geringe Variation / geringes Farbspiel
- V2** Mittlere Variation / mittleres Farbspiel
- V3** Hohe Variation / hohes Farbspiel
- V4** Starke Variation / starkes Farbspiel

402 **Plural non-slip 1**
Steinzeug

2 **Mosaik^{2/4}**

2,5 x 2,5 cm



5 x 5 cm



10 x 10 cm





















3 *Bogen: 297 x 297 mm* *Bogen: 297 x 297 mm* *Bogen: 297 x 297 mm*

5 Nennmaß - cm/in	Beanspruchungsgruppe	2,5 x 2,5 / 1 x 1	5 x 5 / 2 x 2	10 x 10 / 4 x 4
Herstellmaß		23 x 23 x 6,5 mm	47 x 47 x 6,5 mm	97 x 97 x 6,5 mm
6 Oberfläche		eben, matt	eben, matt	eben, matt
m ² - Stück		11 Bögen	11 Bögen	11 Bögen
m ² - kg		12,100	12,331	13,101
7 Paket - Stück		11 Bögen	11 Bögen	11 Bögen
Paket - m ²		1,000	1,000	1,000
Paket - kg		12,100	12,331	13,101
Palette - m ²		48,000	64,000	64,000
Palette - kg		580,800	789,184	838,464
8 Produktnorm		Bib	Bib	Bib
Trittsicherheit		9 R10/B	R10/B	R10/B
10 Belastung		1	1	1
13 (aktivweiß) 15 V0		4 902-2120H 11	905-2120H 14	910-2120H
		Preisgr. A238 (m ²)	Preisgr. A205 (m ²)	Preisgr. A166 (m ²)

Wir arbeiten ausschließlich auf Grundlage unserer Allgemeinen Geschäftsbedingungen (Stand: 03/2022).

Preisliste Agrob Buchtal 2025, Stand Dezember 2024

Es werden folgende Symbole verwendet:

-  Hytect-Oberfläche
(Erklärung siehe Seite 10 und 527)
-  Protecta-Vergütung
(Erklärung siehe Seite 527)
-  Neuheiten
-  Nicht mit Schuhen zu begehen
-  Rektifiziert
-  Konisch rektifiziert
-  Rektifizierte Wandfliesen mit gerundeten/geschliffenen Kanten
-  Auftragsfertigung: Rückgabe und/oder Stornierung bestellter Ware nicht möglich
-  Blindenleitsystem analog den Anforderungen aus DIN 32984.
-  Frostbeständig
- 
 R9 Trittsicher
- 
 B Trittsicher Barfußbereich
-  Made in Germany
-  Thermoplastische Verklebung
-  in weiteren Farben lieferbar
-  6 mm Fliese



Management System
ISO 9001:2015



www.tuv.com
ID 9000027001

Agrob Buchtal Solar Ceramics GmbH
Buchtal 1, D-92521 Schwarzenfeld
Tel.: +49 (0) 94 35-391-0
Fax: +49 (0) 94 35-391-34 52

E-Mail: info@agrob-buchtal.de
Internet: www.agrob-buchtal.de

