



Programme of Delivery

**2025**

## Solid Ground

The Solid Ground series, designed in collaboration with Hadi Teherani, combines concrete and travertine to create an elegant design. With modern colors, modular formats and 145 cm long stair tiles, it offers creative possibilities for residential and commercial spaces – ideal for architects, planners and builders. For further information, refer to the pages 412 - 423.



## Ocean

Ocean offers a fascinating color range for pools, spas and wellness. Inspired by water and nature, iridescent shades of blue, green and sand combine vibrancy with elegance. Perfect for atmospheric designs, complemented by versatile formats and the possibility of combination with other series. For further information, refer to the pages 316 - 321.

## Streetlife Metallic

The Streetlife Metallic series combines urban coolness with the charm of lived-in surfaces and is reminiscent of brushed metal with traces of rust and oxidation. The powerful aesthetics and metallic colors create a timeless, urban flair, ideal for modern living concepts, lofts and public spaces. The tiles are available in versatile formats and robust thicknesses, and thus a perfect solution for private and commercial applications. For further information, refer to the pages 468 - 471.



Introduction	4 – 25
Product finder	26 – 35

## Series A–Z

<b>Alcina</b>	38 – 45
<b>Amano</b>	46 – 49
<b>Area Pro</b>	50 – 77
<b>Aruba</b>	78 – 85
<b>Ascona</b>	86 – 99
<b>Basic Stone</b>	100 – 103
<b>Basis</b>	104 – 113
Basis 1	107 – 108
Basis 1+	109
Basis 2	110
Basis 3	111 – 112
Basis 4	113
<b>Basis Pro</b>	114 – 121
<b>Orientation Aids for the Blind</b>	122 – 127
<b>Bliss</b>	128 – 131
<b>Cedra</b>	132 – 139
<b>Chroma</b>	140 – 149
Chroma non-slip	150 – 159
Chroma unglazed	160 – 167
<b>Concrete</b>	168 – 171
<b>Craft</b>	172 – 177
<b>Craft Extended</b>	178 – 181
<b>District</b>	182 – 185
<b>Eladuct + Keraion ELA</b>	186 – 189
<b>Emotion</b>	190 – 195
<b>Emotion Grip</b>	196 – 201
<b>Evalia</b>	202 – 207
<b>Factory</b>	208 – 217
<b>Ferrum</b>	218 – 221
<b>Fresh</b>	222 – 235
<b>Karl</b>	236 – 241
<b>Keraion - Special Glazes for Operating Theatres</b>	242 – 245
<b>Like</b>	246 – 255
<b>Loop</b>	256 – 263
<b>Lounge</b>	264 – 273
<b>Mandalay</b>	274 – 277
<b>Mando</b>	278 – 283
<b>Marble &amp; More</b>	284 – 287
<b>Natural Ceramics</b>	288 – 291
<b>New Market</b>	292 – 299
<b>Nivella</b>	300 – 301
<b>Nova</b>	302 – 309

<b>Oak</b>	310 – 315
<b>NEW Ocean</b>	316 – 321
<b>Pattern</b>	322 – 333
<b>Pizarro</b>	334 – 337
<b>Plural</b>	338 – 357
Plural non-slip	358 – 365
Plural unglazed	366 – 371
<b>Quarzit</b>	372 – 379
<b>Savona</b>	380 – 385
<b>Senja Pure</b>	386 – 391
<b>Sento</b>	392 – 399
<b>Sierra</b>	400 – 405
<b>Skill</b>	406 – 411
<b>NEW Solid Ground</b>	412 – 423
<b>Solid Rock</b>	424 – 431
<b>NEW Stone Concept</b>	432 – 437
<b>NEW Stone Duo</b>	438 – 445
<b>Stories</b>	446 – 455
<b>NEW Strata</b>	456 – 467
<b>NEW Streetlife Metallic</b>	468 – 471
<b>Trio</b>	472 – 481
<b>Unique</b>	482 – 487
<b>Valley</b>	488 – 493
<b>Walden</b>	494 – 497

## Index/Technical Information

Article numbers	500 – 510
Models	511 – 512
Model numbers	513
Classification according to NCS/RAL Lightness values	514 – 515
Luminance contrast	516 – 519
Technical Information	520 – 539
World-wide distribution network	542 – 543
Comments	546 – 547

# We understand. Since 1755.



## Reliable

We know a lot about tiles. We have been working with clay since 1755 and have a comprehensive understanding of our material and the production of highest-quality stoneware, porcelain stoneware and earthenware. In our four German production facilities, we are constantly refining our recipes for mixing clay, feldspar, fireclay, kaolin and water. As a natural material which transitions from plastic to solid in carefully monitored firing processes, clay offers endless possibilities for creating ceramic products that help make architecture durable, sustainable and beautiful.



## Versatile

Our products are used far and wide. Indoors and outdoors. From private homes to museums. From hotels to hospitals. From restaurants to offices. From shops to swimming pools. From bathroom floors to building facades. We offer floor, wall and facade tiles for every purpose. And we produce all kinds of special elements to meet almost any specific requirement, whether it's a custom edge for a swimming pool or an integrated orientation aid for visually impaired people. Our tiles can be found everywhere, world-wide.

## Cooperative

No matter how good our products are, we believe that only their application brings out their qualities. That's why we value collaboration and are happy to share our knowledge to find the best solution for each of your architectural projects. Where our standard products reach their limits, we develop customized solutions. Special productions are our speciality. We have the expertise and experience to support architects from the invitation to bid to the project completion. Tell us how we can help you. Contact us if you want to hear what we know.

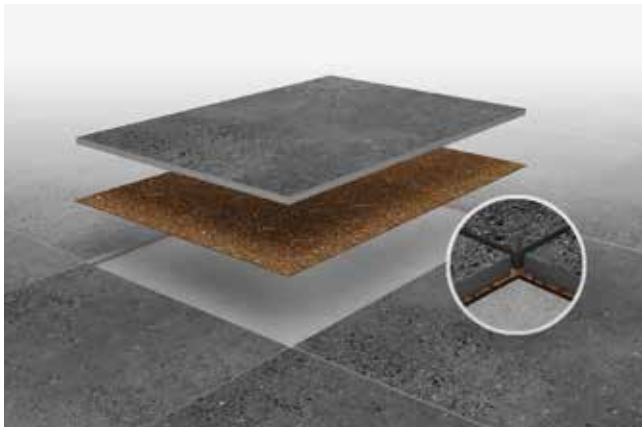
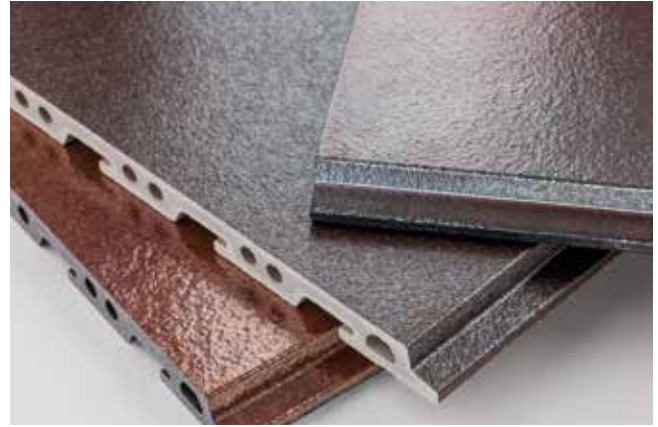

## Innovative

We know how to produce great tiles. Yet we work continuously to make them even better. Craftsmanship and new technologies are combined to create innovative slip-resistant surfaces for wet areas and to develop new and simple methods for working with ceramics, such as Drytile, which allows **adhesive-free installation**. We invest in health and hygiene, as demonstrated by our sustainable Hytect technology, which is used in almost every product we make. In addition to developing innovations in all areas, we are proud of offering tailor-made new solutions and helping architects to realize their best ideas.

## Sustainable

The requirements to be met in the construction sector are continuously increasing. Building owners, planners and users making new demands that increasingly take future developments into account. Energy efficiency, resource conservation and climate change are the key factors in this context, that have a decisive influence. Agrob Buchtal is aware of its responsibility for sustainable building and supports not only the idea of sustainable building through its membership in the German association for sustainable building (Deutsche Gesellschaft für Nachhaltiges Bauen (DGNB)). Early on, we committed, at the industry level, to making all ecological product data important for the planning process of sustainable buildings transparent – within the framework of an Environmental Product Declaration (EPD) according to ISO 14025. Whether a building meets sustainability criteria can be objectively assessed using certification systems. For this, specific product information must be available and documented.



# We are on site.

Produced in Germany  
and available world-wide.

DSA Deutsche Steinzeug America, Inc



You will find your sales contacts (D+A+CH) on the pages 542-543.  
Or please send us a contact inquiry via the website [www.agrob-buchtal.com](http://www.agrob-buchtal.com).



# Modular color systems

Modular color systems are designed for complex requirements in all areas of architectural ceramics. The new Area Pro series is a real all-rounder with its extensive product range of tiles and accessories. It combines sophisticated design with high functionality and thus offers well thought-out solutions for the most diverse areas of application. As a perfect synthesis of function and aesthetics, Emotion supports consistent room concepts for functional and representative areas. With 50 colors matched to one another and a wide variety of formats, Chroma and Plural promote the varied, room-spanning design of wall and floor surfaces. Fresh and Loop offer particularly exciting colors and formats in the mosaic sector.



## Area Pro: naturally intuitive

Good design always conveys an intuitive approach to its use – and thus, designing with Area Pro is also easy. With its earthy shades and pleasant haptics, the wide range of products immediately inspires ideas for their use. The series inspired by fine-grained, layered limestone blends in effortlessly and stands out at the same time. This makes the tiles and their accessories perfect all-rounders in almost every ambience. The series already exudes the potential to become a classic.

## Chroma: the color concept: mixing and combining

When it comes to color design in the pool area, blue is usually the color of choice. However, Chroma also offers warm and neutral shades from the color system inspired by nature – for classics rich in variation, individual accents and a holistic look.

The color scales are divided into six groups: warm, earthy, cool, fresh and sunny shades move around a group of muted, neutral grey shades. Each group contains colors which can be easily combined, both within the group and with other groups. In this way, a consistent and uniform design can always be created.



## Plural: colorful and flexible

The color range specially developed for Plural comprises 50 colors matched to one another. Whether glazed or unglazed, earthenware, stoneware or porcelain stoneware – the narrow 3 mm joint is just as standard with Plural as the pollutant-reducing Hytect coating and the design in various slip-resistance classes. Thus, Plural can be used in many indoor and outdoor areas: from the facade to the floor, from the underground station to the wellness landscape.







## Emotion: modular and timeless

With colors and surfaces matched to one another, slip-resistant tiles from R9 to R12V4 and formats from 30 x 30 to 60 x 60 cm, the tiles of the Emotion series offer architects a great deal of freedom. Emotion ensures good design particularly in areas where transitions between different slip-resistance requirements are needed. This makes front cooking in direct view of restaurant guests just as feasible as the seamless and aesthetically pleasing combination of workshop and showroom in a car dealership.

## Fresh: fresh and modern

Fresh offers a harmonious range of modern, fresh colors in the popular mosaic formats of 2.5 x 2.5 cm and 5 x 5 cm, allowing for unique yet easily achievable designs. A particularly practical feature: The tiles come with color-coordinated, slip-resistant mosaics in R10/B and R11/C.

Color gradients accentuate selected areas, liven up the overall aesthetic and stage artistic interplays with homogeneous tiled surfaces. When used as cladding for individual elements such as columns, partition walls or bar counters, they bring their own rhythm to the room.



## Loop: fine and round

The secret of the depth, luminosity and durability of the colors is the glaze. Up to ten layers are applied to the stoneware and fired in to make them abrasion-proof. We create the glazes ourselves – with selected raw materials. This is how mosaics of radiant, lasting beauty are created.

Loop offers a wide spectrum of intensive and muted color shades ranging from blues and greens to bold yellows, oranges, and reds, as well as gray and brown tones, all the way to deep black. Delicate transparency for lightness and timelessness, luminous richness for accent and expression.

# Innovative.

## Hytect – the air is clean

The Hytect technology is securely baked into the ceramic surface at high temperatures. When light falls on the tiles coated in this way, active oxygen is released through photocatalysis. This process effectively combats bacteria and mould. At the same time, Hytect tiles naturally eutralize air pollutants.

And because they are also hydrophilic, dirt and grease hardly adhere to them. All these effects remain unchanged over the entire service life of the tiles. And thanks to a wide range of products, Hytect ceramics can be used in a wide variety of areas. Our products refined with our Hytect technology are marked with the Hytect logo.

### The effects

Extremely easy to clean

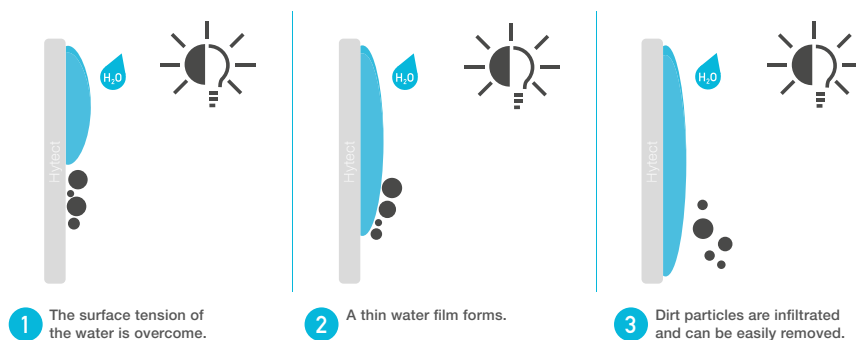

Effective against fungi and bacteria

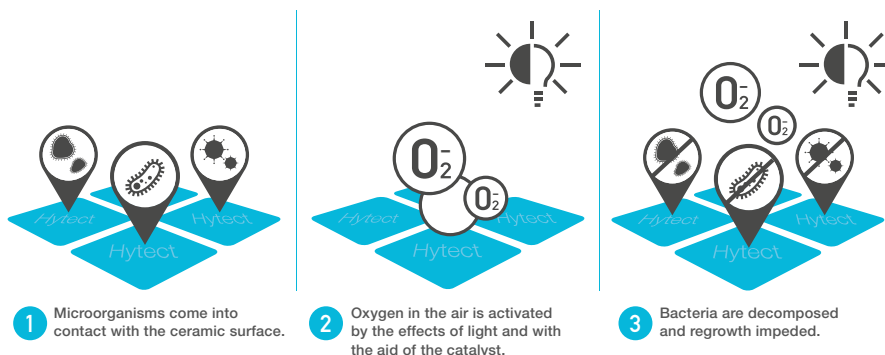

Active elimination of air pollutants

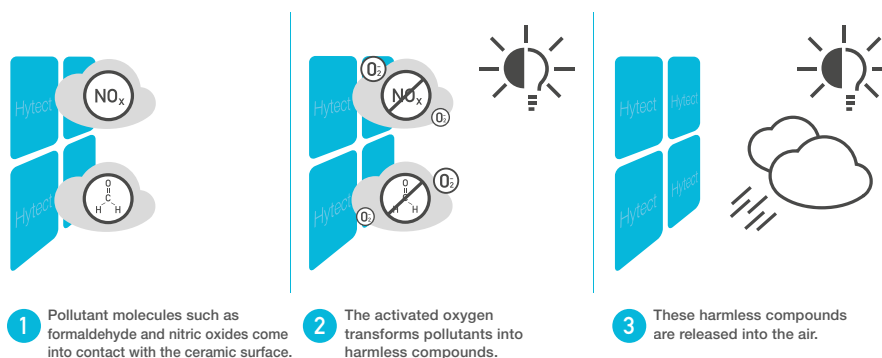

To the Hytect film:



Further information:  
[www.hytect.com](http://www.hytect.com)



# Slip-resistant tiles for all areas of application

Slips, trips, and missteps are the primary cause of accidents in most companies and facilities. Slip-resistant tiles, marked with the GRIP quality seal, are one of our core competences. Since the introduction of the first slip-resistant tiles in the 1930s, we have continuously further developed this innovation through intensive research.

The results include prestigious awards for outstandingly designed surfaces, functional advancements such as quiet and vibration-free movement, and micro-rough special glazes for barefoot areas in swimming pools. The quality of our slip-resistant tiles is ensured through continuous internal laboratory testing and regularly and independently monitored by external institutes and participation in inter-laboratory comparisons with accredited test laboratories.

## The latest innovation in slip-resistant tiles: R12V4

In collaboration with the German designer Sebastian Herkner, a special anti-slip surface was developed for Area Pro. Sebastian Herkner was looking for a pattern that appears spontaneous while still maintaining a certain logic. This is how he came up with the repeating, trapezoidal rectangles and the pattern that can be continued in all four directions. Area Pro is available with various slip-resistant surfaces, including Grid, with a slip resistance of R12V4. None of the slip-resistant surfaces compromise the aesthetics of the tiles. They are also available for large-format tiles, which, due to their properties, can also be used in commercial kitchens.



Designer Sebastian Herkner develops the slip-resistant surface "Grid".



Functionality and beauty combined:  
the R12V4 surface of the Area Pro series.



The design of Grid.

# The in-house planning department

## Efficient support for seven decades

At Agrob Buchtal, high-quality products and expert services go hand in hand. In this way, planners and architects who use our products have had access to our proven architect service since 1952, fostering a collaborative partnership.

A dedicated team of qualified technicians, engineers, architects, designers and color experts ensures swift and seamless realization of individual concepts. Since these experts are not only specialized advisers but also carry out numerous routine tasks, Agrob Buchtal customers can completely concentrate on the realization of their creative ideas. The range of services includes installation plans, quantity calculations, tender specifications, and project-specific technical consulting. Upon request, an on-site contact person is available.



# Individual production

for special requirements.

## More than standard solutions

Creative architects and planners need unlimited design freedom to bring their ideas to life.



## Special colors

Chosen individually or custom-created from nearly 20,000 glaze recipes in any desired shade. This also applies to Corporate Colors that match a company's corporate design (CD).



## Water-jet cutting technique

it allows for the precise shaping of ceramic tiles, including curved forms, which can be assembled according to design specifications.

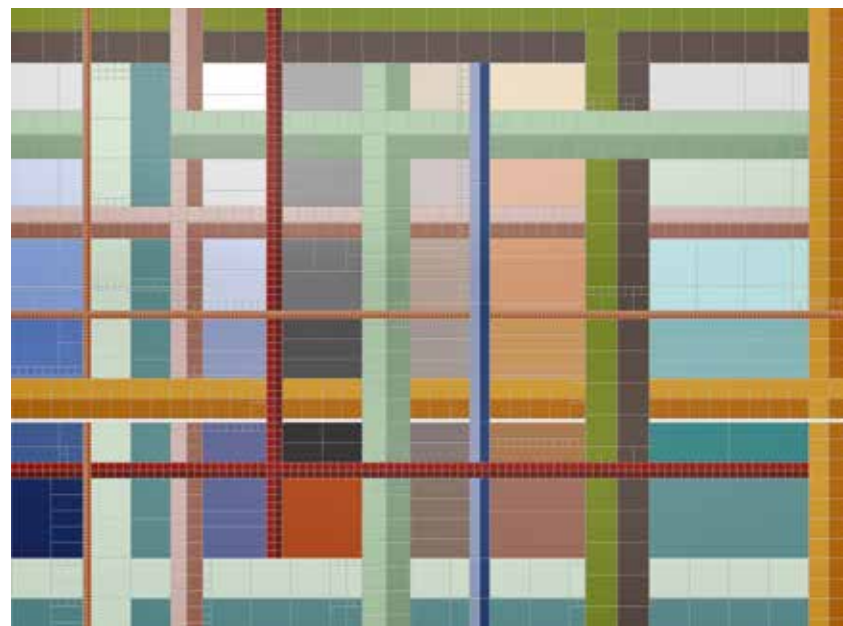

## Special formats

These are in demand for both high-end new constructions and the renovation of historic buildings and are manufactured exactly according to the specifications of the architects.

# Mosaic Designer

## Free your mind

With the new mosaic planning tool, Agrob Buchtal expands the horizon for architects and interior designers with an unlimited range of solutions in terms of form, color and size. The digital service provides scope for new ideas and impresses with its excellent user experience thanks to its intuitive, almost playful usability. A tool with which Agrob Buchtal is revolutionizing the ancient art of mosaics and breathing new life into it.

By entering the desired basic parameters such as the dimensions of the mosaic surface, selection of product series, tile format and joint color, individual color gradients or color blends can be generated automatically. Depending on the size, the desired design is generated and visualized on the screen in the shortest possible time.

Many small tiles are required for an area of 3 x 6 metres, for example. They are digitally arranged and designed in a flash. There is no size limits which makes the Mosaic Designer

from Agrob Buchtal a creative accelerator, especially for the design of swimming pools and wellness facilities, restaurants, hotels, schools and public spaces, including underground stations.

There is a choice of the three mosaic series Loop, Fresh and Plural, which are ideal as pure color system series without surfaces such as wood, concrete, marble or the like and offer a wide spectrum of tonal values for the design. Each design can be saved as a project or sent immediately to Agrob Buchtal as an inquiry.

In addition to graphic gradients and color mixtures, the Mosaic Designer can also implement individual motifs. Images and photos can be directly uploaded using the upload function.

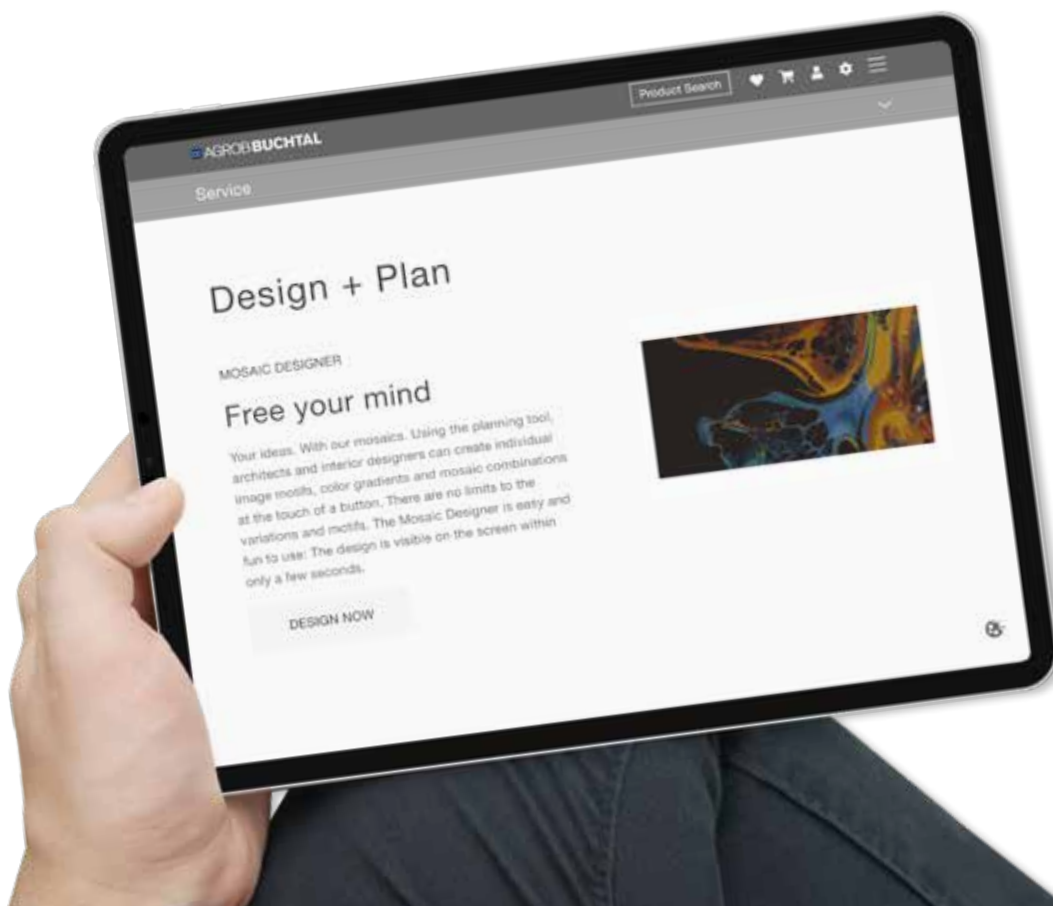

directly to the Mosaic Designer

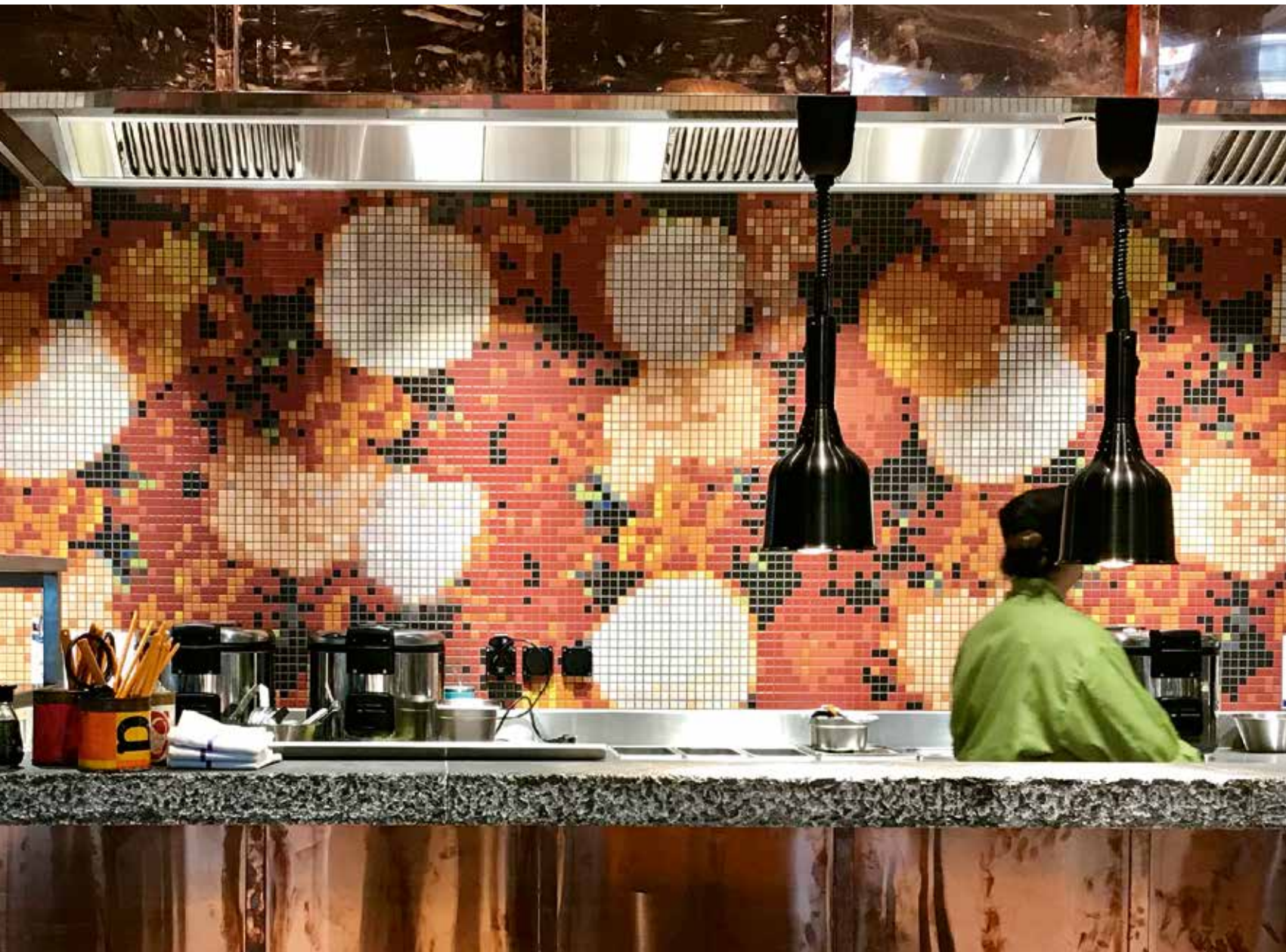

We develop product solutions for all  
**areas of application**



## Retail

Retail concepts require high-quality, authentic materials which are robust and can withstand heavy loads, such as our extra thick tiles or special product solutions such as the Drytile floor tile coated with cork, which is laid dry. This saves an enormous amount of time and is thus an economic advantage for the construction of new buildings or renovation.

## Drytile – As fast as your business



## Extra thick tiles







## Hotel + Gastronomy

Hotels are temporary homes. Well-thought-out interior design helps guests feel at home. Authentic materials that create atmosphere and highlight the special charm of the place are in demand. Tiles have been a popular and versatile design element in architecture for centuries. High-quality ceramics are durable, resistant to wear, color-fast, easy to clean and therefore economical.

## Colorful tiles as a design statement



## Mosaics for wellness areas





## Health + Care

In health and care facilities, the well-being of patients is paramount – whether in patient rooms, operating theatres, treatment rooms, large kitchens, laboratories or therapy baths. The standards of hygiene, cleanliness and accessibility are very high. At the same time, operators want sophisticated interior design with a calming and friendly atmosphere. This positively impacts patients' well-being and supports their recovery. We also provide tailored solutions to meet the unique requirements of health care facilities: Ceramics with a specialized glaze reduce disruptive reflections—ideal for operating rooms and areas where laser technology is used. Special solutions for therapy pools combine functionality with beautiful design.

## Therapy areas



## Ceramics against germs





## Education

Schools, kindergartens, and universities are places of education, just like political, artistic, or musical institutions. An attractively designed environment increases the willingness to learn and has an inspiring effect. And when people feel comfortable, they like to come back. Color is an important element for giving rooms atmosphere and expression. In combination with material and texture, a positive, stimulating environment is created in day-care centres or primary schools, for example. The depth of color, brilliance and expressiveness of ceramics are long-lasting. High-quality ceramics withstands the demands of constant public traffic for decades.

## Modular color systems



## Orientation aid for the blind

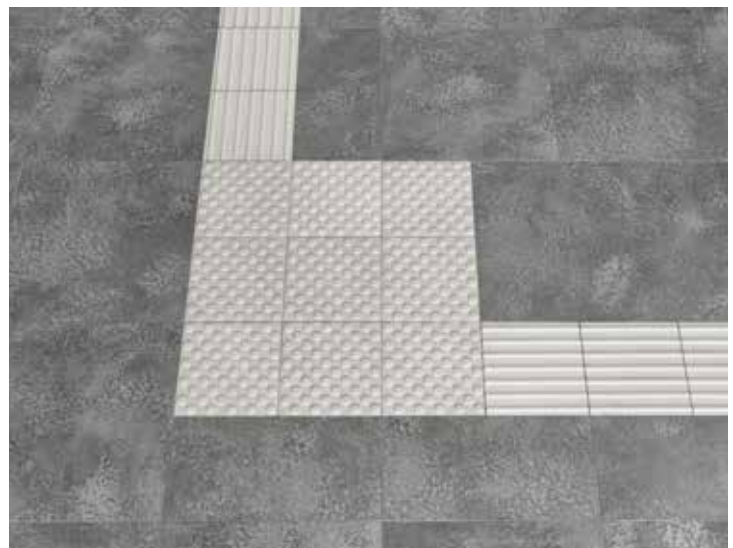



## Industry + Infrastructure

The planning and execution of infrastructure buildings are challenging. Buildings such as railway stations, underground stations, tunnels, or airports should be multifunctional, visually appealing, and integrate seamlessly into the cityscape. Thousands of people come together in these areas every day. High-traffic areas require slip-resistant, durable, low-maintenance building materials, as well as easy-to-clean surfaces. This is where the Hytect tile comes in useful. The patented surface coating activates a natural process that purifies the air and neutralizes nitrogen oxides and odours. Unwanted graffiti is also demonstrably easy to remove. Special products, such as orientation aids for the blind, ensure accessibility and support barrier-free design.





## Pool + Spa

The conception of contemporary pool architecture is complex and must meet high demands. And not only in terms of design: whether sports, leisure and adventure pools, therapy pools, private and hotel pools, sports and competition pools – they all have to be safe, easy to clean and inexpensive to maintain. Tiles meet these functional requirements: for example, with slip-resistant special surfaces ensuring a safe foothold even when wet. Modularly combinable tiles and special pieces are important for a consistent design from the pool and pool surround to all adjacent areas such as showers, saunas, changing rooms or restaurants.

Further information on the products can be found in the Pool + Spa programme of delivery.

### Consistent design in all pool areas



### Color gradients



### Indoors and outdoors

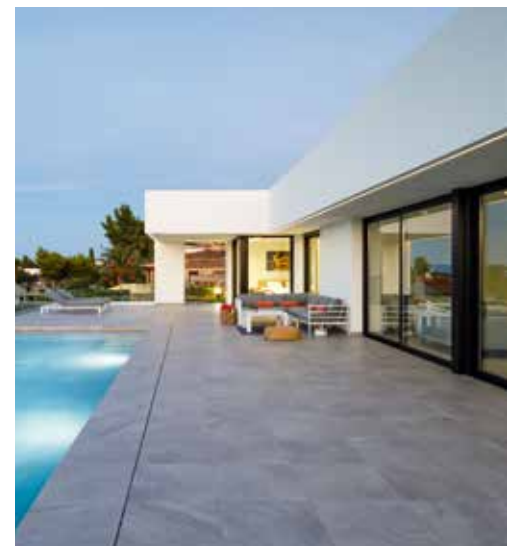



## Facade

The facade is more than a protective outer shell. It covers the building like a dress. Its design not only shapes the building itself, but also often has a visible effect on the urban environment. As a building material which has been tried and tested for thousands of years, ceramics also has ideal properties for the facade. It is non-combustible, resistant to chemicals, light-fast, pressure-, impact- and scratch-resistant. In addition, it is biologically safe for buildings, offers an unlimited service life, and is fully recyclable. Design possibilities emerge from the interplay of color, surface, format, and shape in all variations: bold, vibrant tones or subdued monochromatic shades. Glazed, unglazed, matt or glossy surfaces. Large-size panels, narrow oblong formats or mosaics for organic shapes. Three-dimensional shapes, baguettes or tubes.

## KerAion®



## KeraShape®



KeraTwin®



KeraJoin®



KeraYou®





## Living

Wall and floor coverings significantly characterize the overall impression of rooms. When planning contemporary bathrooms and living spaces, design usually is the top priority when it comes to choosing wall and floor coverings. At the same time, the materials used to furnish the home office or dining room, hallway, living room or bathroom should also be hard-wearing and durable. It is important to create living comfort without compromises, ecologically sustainable, easy to clean and barrier-free. We offer products which meet these requirements and create smart additional benefits with the advantages of the antibacterial Hytect surface. From the mosaic up to large formats.

## Bathrooms







Kitchen

Living room



Terraces



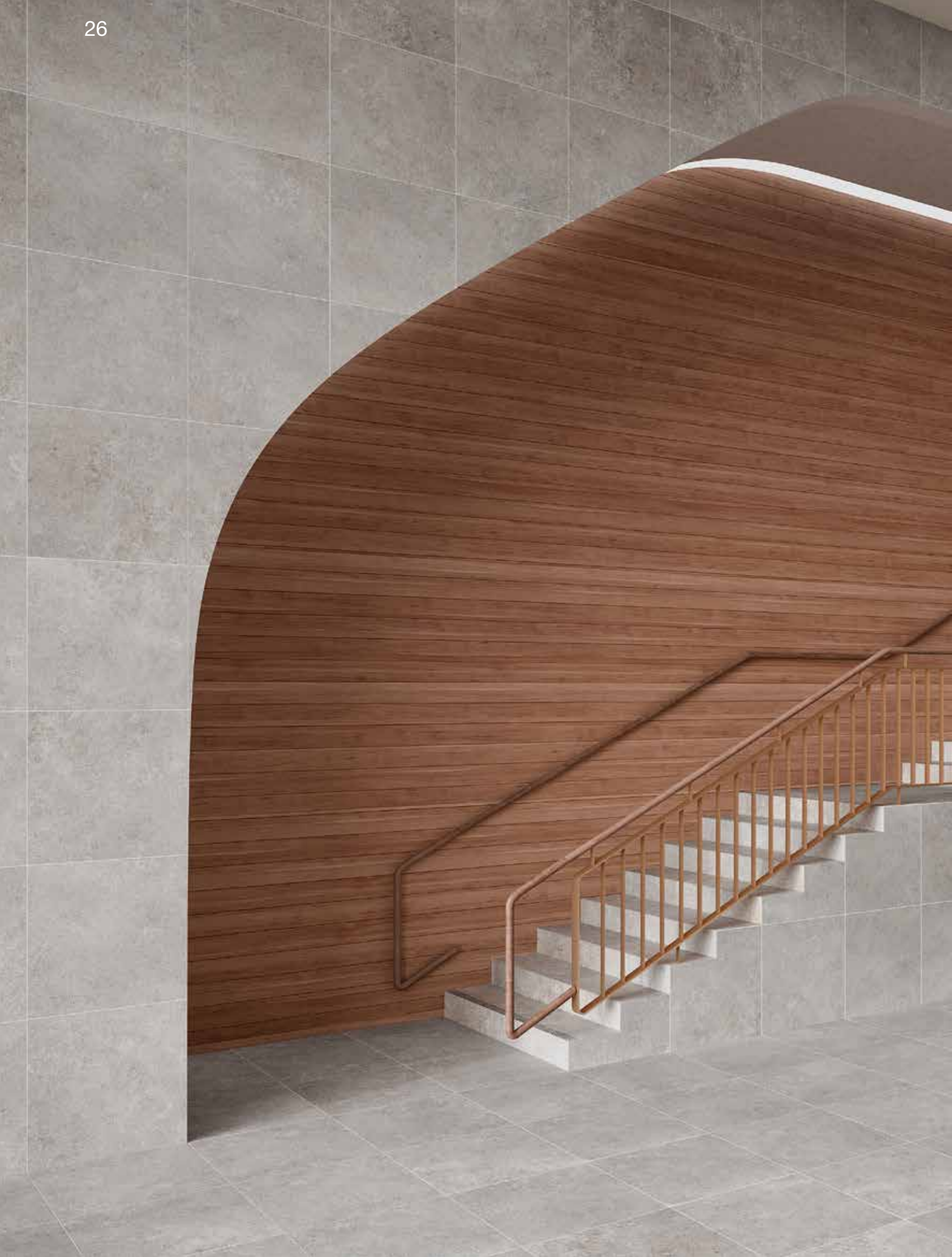



# Product Finder



	Mono-colored	Multicolored	Concrete	Wood	Industrial	Marble	Stone	Vintage	Hytect	Protecta	R9	R10	R10/A	R10/A+B	R10/B	R11	R11/A	R11/B	R11/C	R11V4	R12	R12/C	R12V4	R12V8	R13	R13V10	-/B	-/C	
	Look											Slip resistance																	
	•								•	•						•				•									
	•								•																				
				•		•		•	•			•	•		•	•		•	•			•		•					
						•		•		•																			
						•		•		•		•																	
	•	•			•	•		•																					
	•					•		•		•																			
	•					•		•		•		•	•		•	•		•				•		•		•	•	•	•
						•		•		•		•	•		•		•					•							
	•			•		•		•		•		•																	
	•					•		•		•																			
	•					•		•		•																			
	•					•		•		•																			
	•					•		•		•																			
	•					•		•		•																			
	•					•		•		•																			
	•					•		•		•																			
	•					•		•		•																			
	•					•		•		•																			
	•					•		•		•																			
	•	•				•		•		•																			
	•					•		•		•																			
	•					•		•		•																			
	•	•				•		•		•																			
	•					•		•		•																			
	•					•		•		•																			
	•	•				•		•		•																			

<sup>1</sup>The usability corresponds to DIN 18515-1 or acc. to the certificate of usability of the system provider.





Series	From page	Product category								Color																		
		Floor tiles	Floor tiles extra thick	Decoration	Shower floors	Mosaic	Swimming pool	Skirtings	Patio tiles	Stair tiles	Wall tiles	Products suitable for facades <sup>1</sup>	White	Light-grey	Mid-grey	Dark-grey	Black	Light-blue	Medium-blue	Dark-blue	Beige	Brown	Yellow	Orange	Red	Green	Multicolored	Metallic
Lounge	264	•	•	•	•				•			•	•	•	•					•							•	
Mandalay	274		•							•		•	•		•	•												•
Mando	278		•							•		•	•					•		•	•							
Marble & More	284				•							•		•		•		•	•								•	
Natural Ceramics	288	•																		•	•							
New Market	292		•									•	•	•	•	•				•	•							
Nivella	300																	•										
Nova	302	•			•		•		•					•	•	•				•	•							
Oak	310	•	•				•		•						•						•							
Ocean	316				•					•								•	•	•							•	
Pattern	322	•			•					•		•	•	•	•			•		•								•
Pizarro	334		•							•			•	•	•													
Plural	338	•			•		•		•			•	•	•	•	•	•	•	•	•	•	•	•	•	•	•	•	•
Plural non-slip	358	•			•	•	•		•			•	•	•	•	•	•	•	•	•	•	•	•	•	•	•	•	•
Plural unglazed	366	•			•		•						•	•	•			•	•	•	•	•	•	•		•	•	
Quarzit	372	•			•	•	•	•	•	•			•	•						•	•							
Savona	380	•			•		•						•	•	•	•				•	•							
Senja Pure	386				•					•		•	•							•	•							•
Sento	392	•	•		•		•		•			•	•	•	•	•	•	•	•	•	•	•				•	•	
Sierra	400	•			•		•		•				•		•	•				•								
Skill	406	•					•		•				•	•	•					•								
Solid Ground	412	•	•		•		•		•	•		•	•	•	•					•	•							
Solid Rock	424	•	•		•		•	•	•				•	•	•												•	
Stone Concept	432		•							•																		
Stone Duo	438	•	•		•		•		•				•	•		•												
Stories	446	•	•		•		•	•	•	•			•	•	•					•								
Strata	456	•	•		•		•		•				•	•	•	•				•	•							
Streetlife Metallic	468	•					•		•												•							
Trio	472	•	•		•		•	•	•	•		•		•	•	•	•	•	•	•	•				•	•		
Unique	482	•	•		•		•		•				•		•	•				•	•							•
Valley	488	•			•	•	•	•	•				•	•	•					•	•							
Walden	494	•					•					•								•	•							



<b>Look</b>														<b>Slip resistance</b>																			
<i>Mono-colored</i>		<i>Multicolored</i>		<i>Concrete</i>	<i>Wood</i>	<i>Industrial</i>	<i>Marble</i>	<i>Stone</i>	<i>Vintage</i>	<i>Hytect</i>	<i>Protecta</i>	<i>F9</i>	<i>R10</i>	<i>R10/A</i>	<i>R10/A+B</i>	<i>R10/B</i>	<i>R11</i>	<i>R11/A</i>	<i>R11/B</i>	<i>R11/C</i>	<i>R11V4</i>	<i>R12</i>	<i>R12/C</i>	<i>R12V4</i>	<i>R12V8</i>	<i>R13</i>	<i>R13V10</i>	<i>-/B</i>	<i>-/C</i>				

<sup>1</sup>The usability corresponds to DIN 18515-1 or acc. to the certificate of usability of the system provider.







# Series from A to Z





## Warm and natural

With its naturally textured surfaces, Alcina offers an elegant range of earthy and warm shades for walls and floors in living and wet areas. Alcina can easily be combined with a variety of living styles. The delicately colored wall tiles feature a Hytect surface. Floor tiles in various colors and formats create bold or subtle contrasts. The Sola décor adds stylish variety across all floor colors. This extensive tile range is complemented by matching skirtings, non-slip 5 x 5 cm mosaics, and patio tiles.

Rendering / architect: Stellwerk architekten

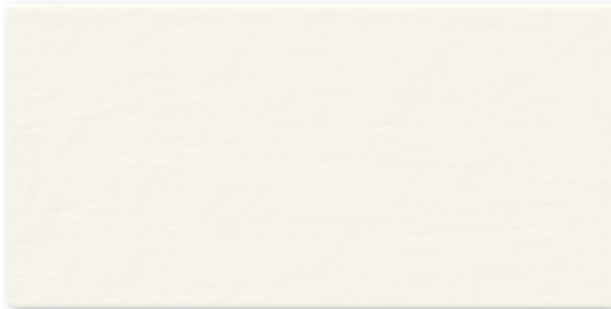

Wall tile 30 x 60 cm, 12 x 24 in, white, structured



Wall tile 30 x 60 cm, 12 x 24 in, beige, structured



Wall tile 30 x 90 cm, 12 x 36 in, white, structured



Wall tile 30 x 90 cm, 12 x 36 in, beige, structured



## Decoration Elements



Border Sola 24.3 x 43.8 cm, crema, structured

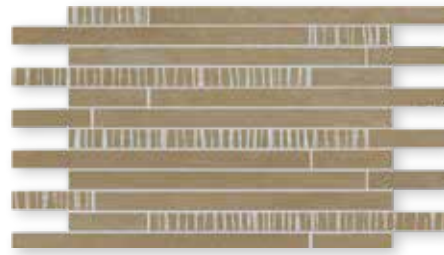

Border Sola 24.3 x 43.8 cm, clay-brown, structured



Border Sola 24.3 x 43.8 cm, pebble-grey, structured

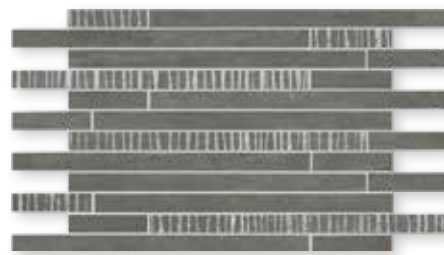

Border Sola 24.3 x 43.8 cm, basalt, structured

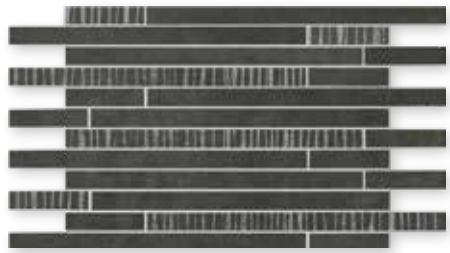

Border Sola 24.3 x 43.8 cm, graphite, structured

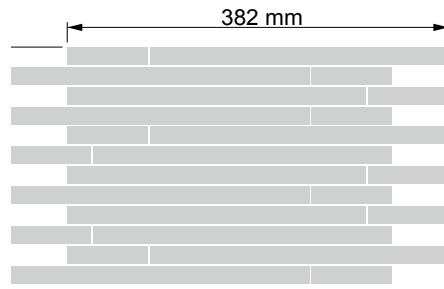

Border: Glass fibre net on reverse side  
Sheet: 240 x 435 mm

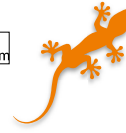

R10/A+B



crema



clay-brown



pebble-grey



basalt

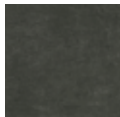

graphite



Floor tile 30 x 60 cm, 12 x 24 in, structured, R10/A+B



Floor tile 60 x 60 cm, 24 x 24 in, structured, R10/A+B



Skirting, cut 7 x 60 cm, 2 13/16 x 24 in, structured

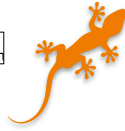

R10/A+B R11/B



### Mosaic 5 x 5 cm, 2 x 2 in



Mosaic sheet 30 x 30 cm, 12 x 12 in, crema, structured, R10/A+B

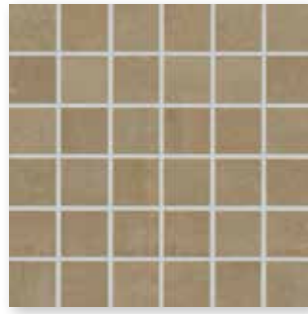

Mosaic sheet 30 x 30 cm, 12 x 12 in, clay-brown, structured, R10/A+B



Mosaic sheet 30 x 30 cm, 12 x 12 in, pebble-grey, structured, R10/A+B

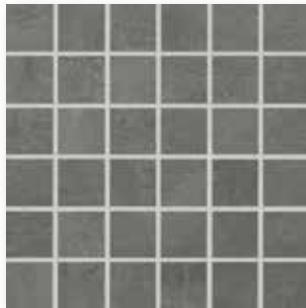

Mosaic sheet 30 x 30 cm, 12 x 12 in, basalt, structured, R10/A+B

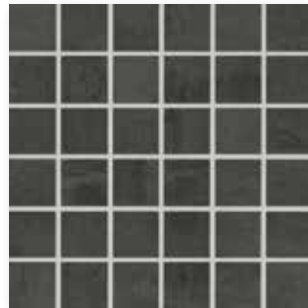

Mosaic sheet 30 x 30 cm, 12 x 12 in, graphite, structured, R10/A+B

Mosaic: glass fibre net on reverse side,  
Sheet: 297 x 297 mm

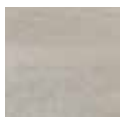

pebble-grey



basalt

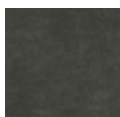

graphite



Patio tile 60 x 60 cm, 24 x 24 in, structured, R11/B

Wall Tiles<sup>5</sup>

30 x 60 cm



30 x 90 cm<sup>1</sup>

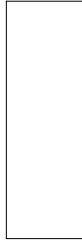

Decoration Elements<sup>2/3/4/6/7</sup>

24,3 x 43,8 cm

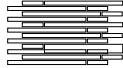

Border Sola,  
Sheet: 240 x 435 mm

Nom. dim. - cm/in	<b>30 x 60</b> / 12 x 24	<b>30 x 90</b> / 12 x 36	<b>24.3 x 43.8</b> / 10 x 18				
Work size	297 x 597 x 6 mm	297 x 897 x 6 mm	240 x 435 x 6 mm				
Surface	structured, silky-matt	structured, silky-matt	structured, matt				
m <sup>2</sup> /m - pieces	5.556/m <sup>2</sup>	3.704/m <sup>2</sup>	2.639/m				
m <sup>2</sup> /m - kg	10.279/m <sup>2</sup>	10.400/m <sup>2</sup>	3.077/m				
Bundle - pieces	13	8	3				
Bundle - m <sup>2</sup> /m	2.340 m <sup>2</sup>	2.160 m <sup>2</sup>	1.137 m				
Bundle - kg	24.050	22.464	3.498				
Pallet - m <sup>2</sup>	112.311	51.836					
Pallet - kg	1.154.400	539.136					
Product standard	BIII	BIII	Bla				
white	<b>203435H</b> Price gr. <b>C68</b> (m <sup>2</sup> )	<b>323437H</b> Price gr. <b>C134</b> (m <sup>2</sup> )					
beige	<b>203436H</b> Price gr. <b>C68</b> (m <sup>2</sup> )	<b>323438H</b> Price gr. <b>C134</b> (m <sup>2</sup> )					
crema			<b>203439</b> Price gr. <b>C510</b> (pce.)				
clay-brown			<b>203440</b> Price gr. <b>C510</b> (pce.)				
pebble-grey			<b>203441</b> Price gr. <b>C510</b> (pce.)				
basalt			<b>203442</b> Price gr. <b>C510</b> (pce.)				
graphite			<b>203443</b> Price gr. <b>C510</b> (pce.)				

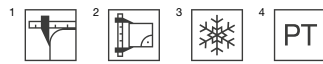

<sup>5</sup> not frost-proof  
<sup>6</sup> Glass fibre net on reverse side  
<sup>7</sup> Decoration elements only available in full boxes.

Mosaic<sup>1/2</sup>

Floor Tiles<sup>1</sup>

Skirting, cut<sup>1</sup>

Patio Tiles<sup>1/3/4</sup>

5 x 5 cm



30 x 60 cm

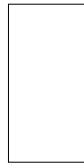

60 x 60 cm



7 x 60 cm



60 x 60 cm

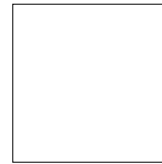

protected

Sheet: 297 x 297 mm

	5 x 5 / 2 x 2	30 x 60 / 12 x 24	60 x 60 / 24 x 24	7 x 60 / 2 13/16 x 24	60 x 60 / 24 x 24	Nom. dim. - cm/in
	47 x 47 x 6	297 x 597 x 6 mm	597 x 597 x 6 mm	70 x 597 x 6 mm	597 x 597 x 20 mm	Work size
	structured, matt	structured, matt	structured, matt	structured, matt	structured, matt	Surface
	11.111 sheets	5.556/m <sup>2</sup>	2.778/m <sup>2</sup>	1.667/m	2.778/m <sup>2</sup>	m <sup>2</sup> /m - pieces
	11.488/m <sup>2</sup>	13.273/m <sup>2</sup>	13.581/m <sup>2</sup>	0.938/m	45.273/m <sup>2</sup>	m <sup>2</sup> /m - kg
	11 sheets	10	5	38	2	Bundle - pieces
	0.990 m <sup>2</sup>	1.800 m <sup>2</sup>	1.800 m <sup>2</sup>	22.795 m	0.720 m <sup>2</sup>	Bundle - m <sup>2</sup> /m
	11.374	23.890	24.445	21.394	32.594	Bundle - kg
	35.640	71.994	64.795		21.598	Pallet - m <sup>2</sup>
	409.464	955.600	880.020		977.820	Pallet - kg
	Bla	Bla	Bla	Bla	Bla	Product standard
	R10/A+B	R10/A+B	R10/A+B		R11/B	Slip resistance
	1	1	1		4	Stress group
	<b>431480</b>	<b>431485</b>	<b>431490</b>	<b>431495</b>		crema <input type="checkbox"/> V2
	Price gr. C308 (m <sup>2</sup> )	Price gr. C98 (m <sup>2</sup> )	Price gr. C107 (m <sup>2</sup> )	Price gr. C440 (pce.)		
	<b>431481</b>	<b>431486</b>	<b>431491</b>	<b>431496</b>		clay-brown <input type="checkbox"/> V2
	Price gr. C308 (m <sup>2</sup> )	Price gr. C98 (m <sup>2</sup> )	Price gr. C107 (m <sup>2</sup> )	Price gr. C440 (pce.)		
	<b>431482</b>	<b>431487</b>	<b>431492</b>	<b>431497</b>	<b>434983H</b>	pebble-grey <input type="checkbox"/> V2
	Price gr. C308 (m <sup>2</sup> )	Price gr. C98 (m <sup>2</sup> )	Price gr. C107 (m <sup>2</sup> )	Price gr. C440 (pce.)	Price gr. C200 (m <sup>2</sup> )	
	<b>431483</b>	<b>431488</b>	<b>431493</b>	<b>431498</b>	<b>434984H</b>	basalt <input type="checkbox"/> V2
	Price gr. C308 (m <sup>2</sup> )	Price gr. C98 (m <sup>2</sup> )	Price gr. C107 (m <sup>2</sup> )	Price gr. C440 (pce.)	Price gr. C200 (m <sup>2</sup> )	
	<b>431484</b>	<b>431489</b>	<b>431494</b>	<b>431499</b>	<b>434985H</b>	graphite <input type="checkbox"/> V2
	Price gr. C308 (m <sup>2</sup> )	Price gr. C98 (m <sup>2</sup> )	Price gr. C107 (m <sup>2</sup> )	Price gr. C440 (pce.)	Price gr. C200 (m <sup>2</sup> )	



<sup>1</sup> Glass fibre net on reverse side

<sup>2</sup> High weight only to carry with two persons.

<sup>3</sup> Without Protecta upgrading; with Hytect coating







## Deeply impressive and lively

Inspired by the movement of water, Amano features a finely textured relief surface. In combination with blurred glazes, Amano creates watercolor-like effects, adding natural charm and exclusive liveliness to the series. When light refracts on its glossy surface, Amano captivates with sparkling reflections.

Studio photo / Architect: Anne Doris Fluck / Photo: Jochen Stüber

Mosaic 2.5 x 2.5 cm, 1 x 1 in



Mosaic sheet 30 x 30 cm, 12 x 12 in, cream, relief

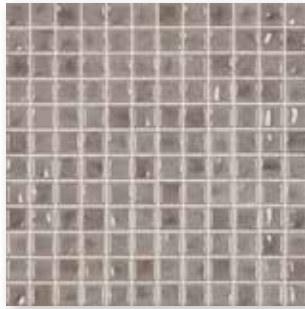

Mosaic sheet 30 x 30 cm, 12 x 12 in, taupe, relief

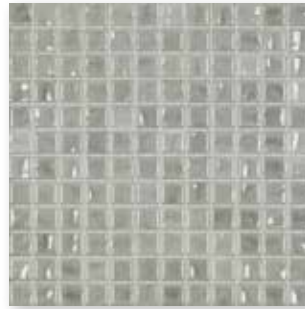

Mosaic sheet 30 x 30 cm, 12 x 12 in, light grey, relief

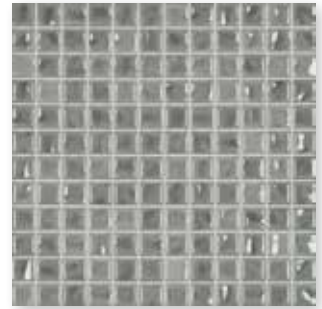

Mosaic sheet 30 x 30 cm, 12 x 12 in, medium grey, relief

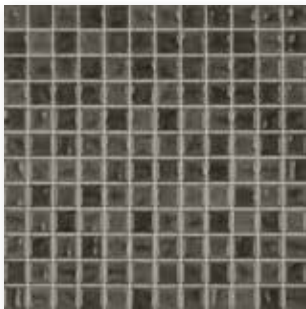

Mosaic sheet 30 x 30 cm, 12 x 12 in, anthracite, relief

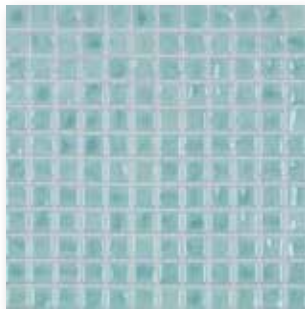

Mosaic sheet 30 x 30 cm, 12 x 12 in, ice blue, relief

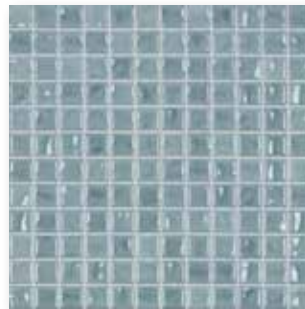

Mosaic sheet 30 x 30 cm, 12 x 12 in, silk blue, relief

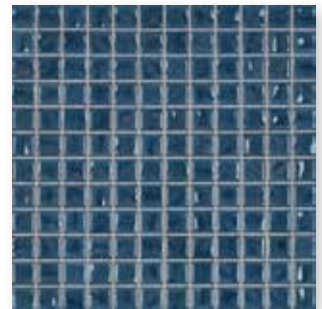

Mosaic sheet 30 x 30 cm, 12 x 12 in, pure blue, relief



Mosaic sheet 30 x 30 cm, 12 x 12 in, metallic, relief



Mosaic sheet 30 x 30 cm, 12 x 12 in, medium grey-metallic-mix, relief



Mosaic sheet 30 x 30 cm, 12 x 12 in, taupe-metallic-mix, relief



Mosaics glued thermoplastically on back of Agrob Buchtal can be used not only in dry zones but also without any problems in underwater areas (e.g. swimming pools/whirlpools) as well as in permanently wet areas.



Mosaic

2,5 x 2,5 cm

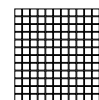

Sheet: 297 x 297 mm



						<b>2.5 x 2.5</b> / 1 x 1		Nom. dim. - cm/in
						23 x 23 x 6.5 mm		Work size
						relief, glossy		Surface
						11 sheets		m <sup>2</sup> - pieces
						12.100		m <sup>2</sup> - kg
						11 sheets		<b>Bundle</b> - pieces
						1.000		<b>Bundle</b> - m <sup>2</sup>
						12.100		<b>Bundle</b> - kg
						48.000		<b>Pallet</b> - m <sup>2</sup>
						580.800		<b>Pallet</b> - kg
						Blb		Product standard
						1		Stress group
						<b>41920H</b>	<b>3</b>	
						Price gr. <b>A250</b> (m <sup>2</sup> )		cream <input type="checkbox"/> V1
						<b>41921H</b>	<b>3</b>	
						Price gr. <b>A250</b> (m <sup>2</sup> )		taupe <input type="checkbox"/> V1
						<b>41922H</b>	<b>3</b>	
						Price gr. <b>A250</b> (m <sup>2</sup> )		light-grey <input type="checkbox"/> V1
						<b>41923H</b>	<b>3</b>	
						Price gr. <b>A250</b> (m <sup>2</sup> )		medium grey <input type="checkbox"/> V1
						<b>41924H</b>	<b>2</b>	
						Price gr. <b>A250</b> (m <sup>2</sup> )		anthracite <input type="checkbox"/> V1
						<b>41925H</b>	<b>3</b>	
						Price gr. <b>A250</b> (m <sup>2</sup> )		ice blue <input type="checkbox"/> V1
						<b>41926H</b>	<b>3</b>	
						Price gr. <b>A250</b> (m <sup>2</sup> )		silk blue <input type="checkbox"/> V1
						<b>41927H</b>	<b>2</b>	
						Price gr. <b>A250</b> (m <sup>2</sup> )		pure blue <input type="checkbox"/> V1
						<b>41928H<sup>1</sup></b>	<b>2</b>	
						Price gr. <b>A475</b> (pce.)		metallic <input type="checkbox"/> V2
						<b>41929H<sup>1</sup></b>	<b>2</b>	
						Price gr. <b>A458</b> (pce.)		medium grey-metallic-mix <input type="checkbox"/> V2
						<b>41930H<sup>1</sup></b>	<b>2</b>	
						Price gr. <b>A458</b> (pce.)		taupe-metallic-mix <input type="checkbox"/> V2

<sup>1</sup> Not or only to a limited extent resistant to acids and alkalis.



Rendering

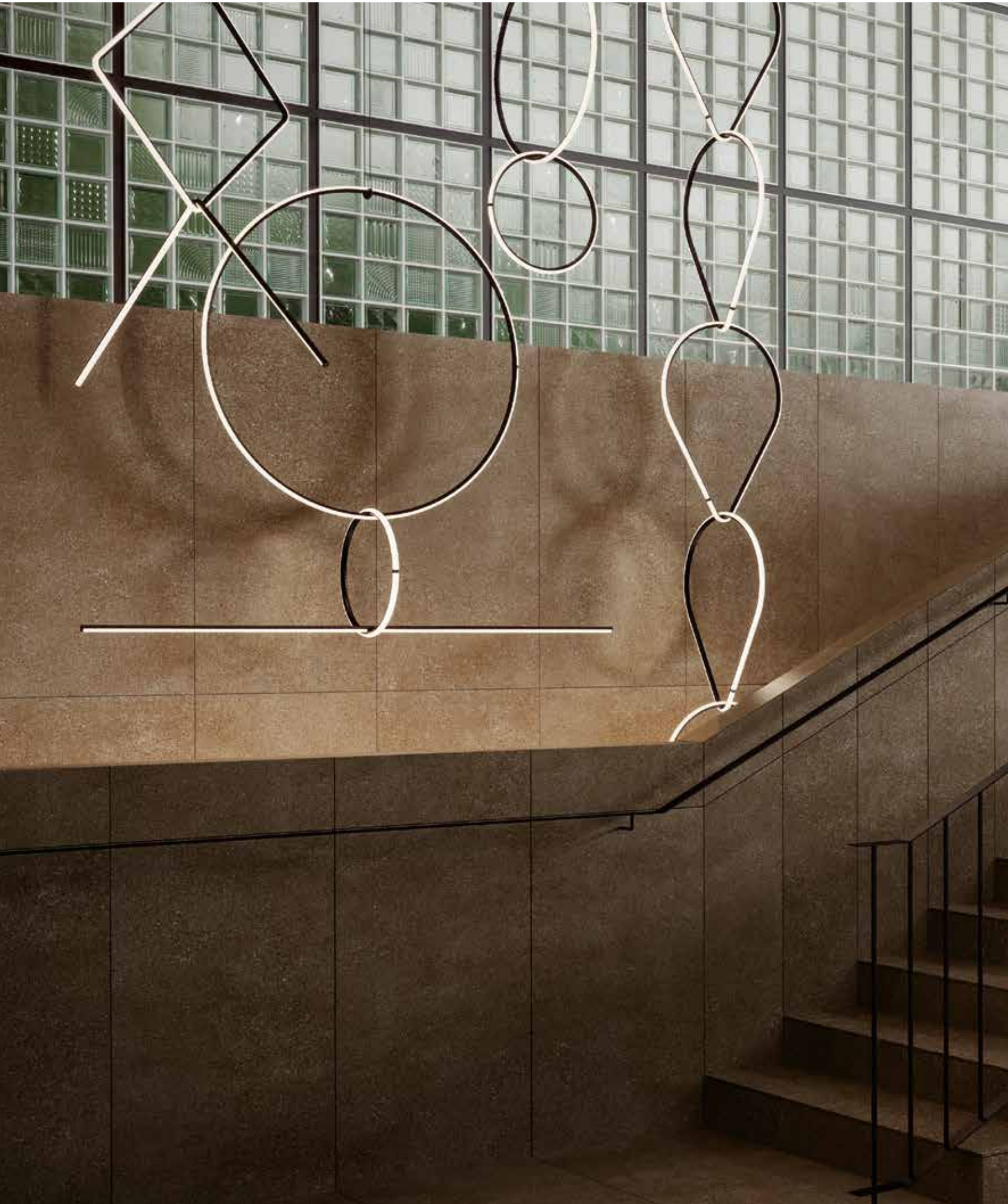



# Area Pro comes naturally

Like the best design objects that intuitively reveal their use, the Area Pro series feels natural and easy to work with. With its earthy colors and pleasant tactility, the wide range of ceramic products offered by Area Pro immediately spurs ideas on how to use them. The Area Pro series, which is inspired by fine-grained, layered limestone, seamlessly blends in while standing out. This makes these tiles and accessories reliable versatile all-rounders in nearly any setting. The series already exudes the potential



Rendering

to become a classic. Area Pro is the ceramic equivalent of the little black dress or a classic white shirt. Whether in office buildings, residential buildings or leisure facilities — like the fashion classics, the series is convincing in any environment and is thus a true all-rounder. All tiles can be installed in any direction. In addition, they impress with their versatility and a variety of formats and color shades. All Area Pro colors are coordinated with the Chroma and Plural series by Agrob Buchtal, allowing for diverse combinations. In addition, customized projects are also possible with this series.





## Grid

In order to live up to its own claim of combining high functionality with sophisticated design, Agrob Buchtal engaged design shooting star Sebastian Herkner, who normally works for brands such as Thonet, Ligne Roset or Moroso. He created a completely new design for the surface of the highest slip-resistance class. The result: "the Grid".



# Smart features

## Always perfect grip



Area Pro is available with diverse slip-resistant surfaces, including Grid with a slip resistance of R12V4.

## Sustainable, thin wall tiles



6 mm thin wall tiles require less material, reducing energy consumption during production and transport, as well as lowering weight.

## Innovation Drytile



The Drytile system is available for floor tiles between 30 x 60 cm and 60 x 120 cm. Drytile is an innovative technology at which a cork compound is applied on the back of the tiles. Thanks to this cork layer, the tiles can be laid without the use of adhesive.

## Hytect hygienic surface



Area Pro tiles feature sustainable Hytect surface, which makes them extremely easy to clean. In addition, Hytect protects ceramic tiles against bacteria and mould and neutralizes air pollutants and unpleasant odours.

## Ceramic channel cover



For tiles laid around the pool in swimming baths, Agrob Buchtal offers the appropriate termination which ensures visual continuity: a channel cover with water-cut openings.



R10/A R10/B R11/B R11/C R12/C R12V4



Surfaces: Floor Tiles



smooth

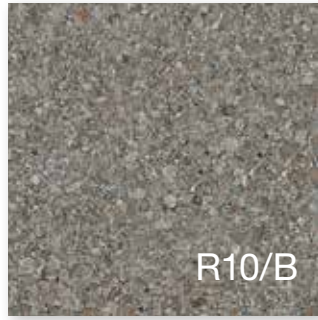

smooth

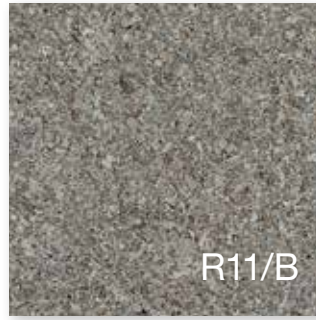

smooth

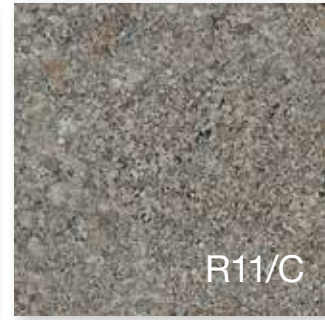

smooth



brick



platinum



clay



sand-grey



nutmeg



stone



sand



pebble



sand-beige



basalt



sand-white



anthracite



Floor tile 15 x 15 cm, 6 x 6 in, smooth, R10/B  
Floor tile 15 x 15 cm, 6 x 6 in, smooth, R11/C



Floor tile 20 x 20 cm, 8 x 8 in, smooth, R10/A  
Floor tile 20 x 20 cm, 8 x 8 in, Softcorn 2, R11/B  
Floor tile 20 x 20 cm, 8 x 8 in, Perlstic, R12/C  
Floor tile 20 x 20 cm, 8 x 8 in, Grid, R12V4



Floor tile 30 x 30 cm, 12 x 12 in, smooth, R10/A  
Floor tile 30 x 30 cm, 12 x 12 in, smooth, R11/B

Mosaic

5 x 5 cm, 2 x 2 in



Mosaic sheet 30 x 30 cm, 12 x 12 in, smooth, R10/B

Mosaic

10 x 10 cm, 4 x 4 in



Mosaic sheet 30 x 30 cm, 12 x 12 in, smooth, R10/B  
Mosaic sheet 30 x 30 cm, 12 x 12 in, smooth, R11/C



Mosaics glued thermoplastically on back of Agrob Buchtal can be used not only in dry zones but also without any problems in underwater areas (e.g. swimming pools/whirlpools) as well as in permanently wet areas (e.g. pool surrounds/showers).



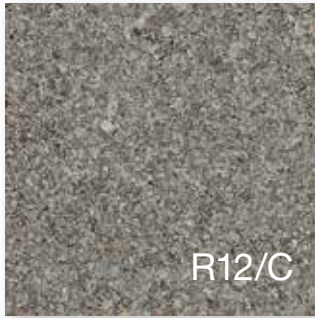

smooth

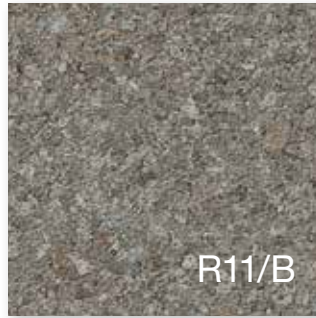

Softcorn 2

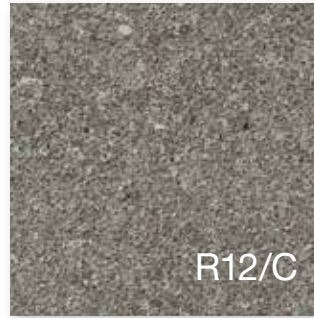

Perlstick



Grid



Oblong format 10 x 60 cm, 4 x 24 in, smooth, R10/A



Oblong format 15 x 60 cm, 6 x 24 in, smooth, R10/A



Floor tile 30 x 60 cm, 12 x 24 in, smooth, R10/A  
 Floor tile 30 x 60 cm, 12 x 24 in, smooth, R11/B  
 Floor tile 30 x 60 cm, 12 x 24 in, smooth, R12/C



Floor tile 60 x 60 cm, 24 x 24 in, smooth, R10/A  
 Floor tile 60 x 60 cm, 24 x 24 in, smooth, R11/B  
 Floor tile 60 x 60 cm, 24 x 24 in, Grid, R12V4



R10/A R11/B



brick



platinum



clay



sand-grey



nutmeg



stone



sand



pebble



sand-beige



basalt



sand-white



anthracite



Floor tile 90 x 90 cm, 36 x 36 in, smooth, R10/A



Floor tile 60 x 120 cm, 24 x 48 in, smooth, R10/A  
Floor tile 60 x 120 cm, 24 x 48 in, smooth, R11/B



Stair tile 30 x 30 cm, 12 x 12 in,  
(with grooves), smooth, R10/A

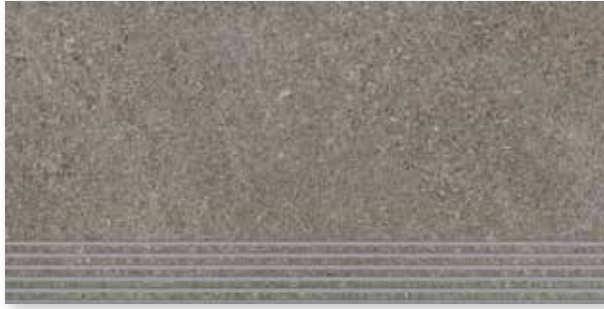

Stair tile 30 x 60 cm (with grooves), 12 x 24 in, smooth, R10/A



Stair tile with bevel 31 x 145 cm, 12.4 x 58 in, smooth, R10/A



Riser 28 x 145 cm, 11.2 x 58 in, smooth, R10/A



Stair edge 4 x 60 cm, 1.6 x 24 in, smooth, R10/A



R10/A R10/B R11 R11/B



brick

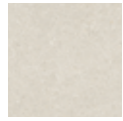

platinum



clay



sand-grey



nutmeg



stone



sand



pebble



sand-beige



basalt



sand-white



anthracite



Skirting, rounded 7 x 30 cm, 2.8 x 12 in, smooth



Skirting, rounded 7 x 60 cm, 2 13/16 x 24 in, smooth



Cove skirting 10 x 10 cm, 4 x 4 in, smooth, R10/A

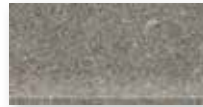

Cove skirting 10 x 10 cm, 4 x 8 in, smooth, R10/A



Cove skirting 10 x 10 cm, 4 x 12 in, smooth, R10/A



Cove skirting 10 x 60 cm, 4 x 24 in, smooth, R10/A



Internal corner for cove skirting, smooth



External corner for cove skirting, smooth



Shower tub system Strip 10 x 10 cm, 4 x 4 in, smooth, R10/B



Shower tub system Corner 10 x 10 cm, 4 x 4 in, smooth, R10/B



anthracite

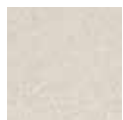

platinum



Guide tile 30 x 30 cm, 12 x 12 in, ribbed structure, R11

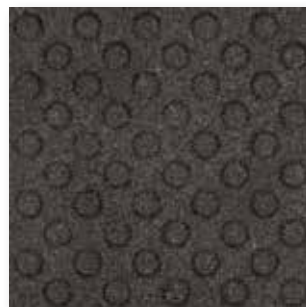

Guide tile 30 x 30 cm, 12 x 12 in, knob structure, R11



Guide tile 30 x 30 cm, 12 x 12 in, smooth, R11



sand



sand-beige



sand-grey



pebble



basalt



anthracite



Patio tile 60 x 60 cm, 24 x 24 in, smooth, R11/B



sand-beige



sand-grey



basalt



Patio tile decor Square, 60 x 60 cm, 24 x 24 in, smooth, R11/B



Wall tile 30 x 60 cm, 12 x 24 in, white, smooth



Wall tile 30 x 60 cm, 12 x 24 in, grey, smooth



Wall tile 30 x 60 cm, 12 x 24 in, beige, smooth

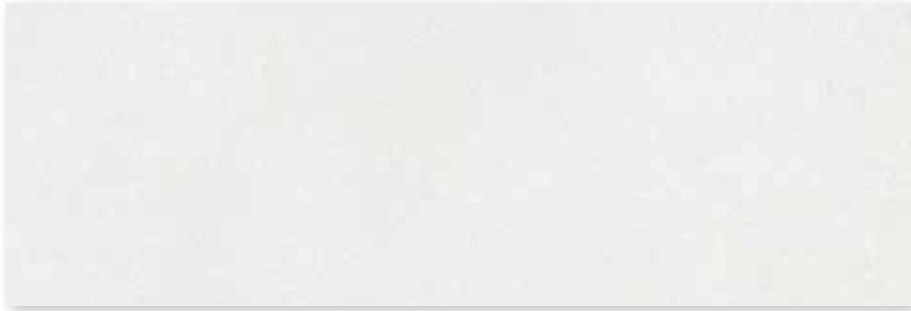

Wall tile 30 x 90 cm, 12 x 36 in, white, smooth



Wall tile 30 x 90 cm, 12 x 36 in, grey, smooth



Wall tile 30 x 90 cm, 12 x 36 in, beige, smooth



R11/B R11/C



brick



platinum



clay



sand-grey



nutmeg



stone



sand



pebble



sand-beige



basalt



sand-white



anthracite

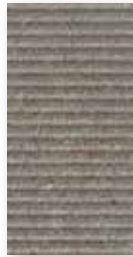

Grooved tile 12.5 x 25 cm,  
5 x 10 in, grooved, R11/C

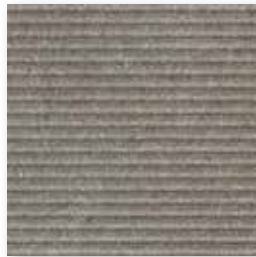

Grooved tile 25 x 25 cm,  
10 x 10 in, grooved, R11/C



Grooved tile 50 x 25 cm, 20 x 10 in, grooved, R11/C



### Gutter Tiles (trough depth: 5 mm)



Gutter tile, 50 x 25 cm, 20 x 10 in,  
smooth, R11/B



Gutter tile, mitred pair,  
smooth, R11/B



Gutter tile with outlet  
smooth, R11/B



Terminal piece  
smooth, R11/B

### Ceramic channel cover



Ceramic channel cover  
corner solution 30 x 30 cm, 12 x 12 in

Ceramic channel cover  
25 x 50 cm, 10 x 20 in



For details relating to gutter tiles and ceramic channel cover,  
refer to the Pool + Spa programme of delivery.

Wall Tiles<sup>4</sup>

Mosaic<sup>1/2</sup>

30 x 60 cm



30 x 90 cm<sup>3</sup>

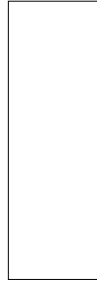

5 x 5 cm



10 x 10 cm



10 x 10 cm



	Sheet 297 x 297 mm		Sheet 297 x 297 mm	Sheet 297 x 297 mm
Nom. dim. - cm/in	<b>30 x 60</b> / 12 x 24	<b>30 x 90</b> / 12 x 36	<b>5 x 5</b> / 2 x 2	<b>10 x 10</b> / 4 x 4
Work size	297 x 597 x 6 mm	297 x 897 x 6 mm	47 x 47 x 6.5 mm	97 x 97 x 6.5 mm
Surface	smooth, stone-matt	smooth, stone-matt	smooth, matt	smooth, matt
m <sup>2</sup> - pieces	5.556	3.704	11 sheets	11 sheets
m <sup>2</sup> - kg	10.279	10.400	12.331	13.101
Bundle - pieces	13	8	11 sheets	11 sheets
Bundle - m <sup>2</sup>	2.340	2.160	1.000	1.000
Bundle - kg	24.050	22.464	12.331	13.101
Pallet - m <sup>2</sup>	112.311	51.836	64.000	64.000
Pallet - kg	1,154.400	539.136	789.184	838.464
Product standard	BIII	BIII	Bla	Bla
Slip resistance			R10/B	R10/B
Stress group			1	1
white <input type="checkbox"/>	<b>203232H</b> Price gr. <b>A76</b> (m <sup>2</sup> )	<b>323235H</b> Price gr. <b>A166</b> (m <sup>2</sup> )		
grey <input type="checkbox"/>	<b>203233H</b> Price gr. <b>A76</b> (m <sup>2</sup> )	<b>323236H</b> Price gr. <b>A166</b> (m <sup>2</sup> )		
beige <input type="checkbox"/>	<b>203234H</b> Price gr. <b>A76</b> (m <sup>2</sup> )	<b>323237H</b> Price gr. <b>A166</b> (m <sup>2</sup> )		
anthracite <input type="checkbox"/>			<b>430185H</b> Price gr. <b>A196</b> (m <sup>2</sup> )	<b>430220H</b> Price gr. <b>A148</b> (m <sup>2</sup> )
basalt <input type="checkbox"/>			<b>430186H</b> Price gr. <b>A196</b> (m <sup>2</sup> )	<b>430221H</b> Price gr. <b>A148</b> (m <sup>2</sup> )
pebble <input type="checkbox"/>			<b>430187H</b> Price gr. <b>A196</b> (m <sup>2</sup> )	<b>430222H</b> Price gr. <b>A148</b> (m <sup>2</sup> )
stone <input type="checkbox"/>				<b>430223H</b> Price gr. <b>A148</b> (m <sup>2</sup> )
sand-white <input type="checkbox"/>				<b>430224H</b> Price gr. <b>A148</b> (m <sup>2</sup> )
sand-grey <input type="checkbox"/>			<b>430188H</b> Price gr. <b>A196</b> (m <sup>2</sup> )	<b>430225H</b> Price gr. <b>A148</b> (m <sup>2</sup> )
sand <input type="checkbox"/>			<b>430189H</b> Price gr. <b>A196</b> (m <sup>2</sup> )	<b>430226H</b> Price gr. <b>A148</b> (m <sup>2</sup> )
nutmeg <input type="checkbox"/>				<b>430227H</b> Price gr. <b>A148</b> (m <sup>2</sup> )
platinum <input type="checkbox"/>			<b>435569H</b> <b>NEW</b> Price gr. <b>A196</b> (m <sup>2</sup> )	<b>430228H</b> Price gr. <b>A148</b> (m <sup>2</sup> )
sand-beige <input type="checkbox"/>			<b>430190H</b> Price gr. <b>A196</b> (m <sup>2</sup> )	<b>430229H</b> Price gr. <b>A148</b> (m <sup>2</sup> )
brick <input type="checkbox"/>				<b>430230H</b> Price gr. <b>A148</b> (m <sup>2</sup> )
clay <input type="checkbox"/>				<b>430231H</b> Price gr. <b>A148</b> (m <sup>2</sup> )
				<b>430232H</b> Price gr. <b>A148</b> (m <sup>2</sup> )
				<b>430233H</b> Price gr. <b>A148</b> (m <sup>2</sup> )
				<b>430234H</b> Price gr. <b>A148</b> (m <sup>2</sup> )
				<b>430235H</b> Price gr. <b>A148</b> (m <sup>2</sup> )
				<b>430236H</b> Price gr. <b>A148</b> (m <sup>2</sup> )
				<b>430237H</b> Price gr. <b>A148</b> (m <sup>2</sup> )
				<b>430238H</b> Price gr. <b>A148</b> (m <sup>2</sup> )
				<b>430239H</b> Price gr. <b>A148</b> (m <sup>2</sup> )
				<b>430240H</b> Price gr. <b>A148</b> (m <sup>2</sup> )
				<b>430241H</b> Price gr. <b>A148</b> (m <sup>2</sup> )
				<b>430242H</b> Price gr. <b>A148</b> (m <sup>2</sup> )
				<b>430243H</b> Price gr. <b>A148</b> (m <sup>2</sup> )



<sup>4</sup> not frost-proof

Floor Tiles

15 x 15 cm



15 x 15 cm



20 x 20 cm



20 x 20 cm



20 x 20 cm



20 x 20 cm



	15 x 15 / 6 x 6	15 x 15 / 6 x 6	20 x 20 / 8 x 8	Softcorn 2 20 x 20 / 8 x 8	Perlstic 20 x 20 / 8 x 8	Grid 20 x 20 / 8 x 8	
	147 x 147 x 10.5 mm	147 x 147 x 10.5 mm	197 x 197 x 10.5 mm	197 x 197 x 10.5 mm	197 x 197 x 10.5 mm	197 x 197 x 10.5 mm	Nom. dim. - cm/in
	smooth, matt	smooth, matt	smooth, matt	structured, matt	fine-grained, matt	profiled, matt	Work size
	44.444	44.444	25.000	25.000	25.000	25.000	Surface
	23.111	23.111	22.900	22.900	22.900	22.900	m <sup>2</sup> - pieces
	27	27	21	21	21	21	m <sup>2</sup> - kg
	0.607	0.607	0.840	0.840	0.840	0.840	Bundle - pieces
	14.040	14.040	19.236	19.236	19.236	19.236	Bundle - m <sup>2</sup>
	48.600	48.600	50.400	50.400	50.400	50.400	Bundle - kg
	1,123.200	1,123.200	1,154.160	1,154.160	1,154.160	1,154.160	Pallet - m <sup>2</sup>
	Bla	Bla	Bla	Bla	Bla	Bla	Pallet - kg
	R10/B	R11/C	R10/A	R11/B	R12/C	R12V4	Product standard
	3	3	3	3	3	3	Slip resistance
	<b>430244H</b>	<b>430256H</b>	<b>430268H</b>	<b>430274H</b>	<b>430280H</b>	<b>430286H</b>	Stress group
	Price gr. A142 (m <sup>2</sup> )	Price gr. A142 (m <sup>2</sup> )	Price gr. A133 (m <sup>2</sup> )	Price gr. A133 (m <sup>2</sup> )	Price gr. A157 (m <sup>2</sup> )	Price gr. A157 (m <sup>2</sup> )	anthracite <input type="checkbox"/> V2
	<b>430245H</b>	<b>430257H</b>	<b>430269H</b>	<b>430275H</b>	<b>430281H</b>	<b>430287H</b>	basalt <input type="checkbox"/> V2
	Price gr. A142 (m <sup>2</sup> )	Price gr. A142 (m <sup>2</sup> )	Price gr. A133 (m <sup>2</sup> )	Price gr. A133 (m <sup>2</sup> )	Price gr. A157 (m <sup>2</sup> )	Price gr. A157 (m <sup>2</sup> )	pebble <input type="checkbox"/> V2
	<b>430246H</b>	<b>430258H</b>	<b>430270H</b>	<b>430276H</b>	<b>430282H</b>	<b>430288H</b>	sand-grey <input type="checkbox"/> V2
	Price gr. A142 (m <sup>2</sup> )	Price gr. A142 (m <sup>2</sup> )	Price gr. A133 (m <sup>2</sup> )	Price gr. A133 (m <sup>2</sup> )	Price gr. A157 (m <sup>2</sup> )	Price gr. A157 (m <sup>2</sup> )	sand <input type="checkbox"/> V2
	<b>430249H</b>	<b>430261H</b>	<b>430271H</b>	<b>430277H</b>	<b>430283H</b>	<b>430289H</b>	platinum <input type="checkbox"/> V2
	Price gr. A142 (m <sup>2</sup> )	Price gr. A142 (m <sup>2</sup> )	Price gr. A133 (m <sup>2</sup> )	Price gr. A133 (m <sup>2</sup> )	Price gr. A157 (m <sup>2</sup> )	Price gr. A157 (m <sup>2</sup> )	sand-beige <input type="checkbox"/> V2
	<b>430250H</b>	<b>430262H</b>	<b>430272H</b>	<b>430278H</b>	<b>430284H</b>	<b>430290H</b>	
	Price gr. A142 (m <sup>2</sup> )	Price gr. A142 (m <sup>2</sup> )	Price gr. A133 (m <sup>2</sup> )	Price gr. A133 (m <sup>2</sup> )	Price gr. A157 (m <sup>2</sup> )	Price gr. A157 (m <sup>2</sup> )	
	<b>435570H NEW</b>	<b>435571H NEW</b>	<b>435572H NEW</b>	<b>435573H NEW</b>	<b>435574H NEW</b>	<b>435575H NEW</b>	
	Price gr. A142 (m <sup>2</sup> )	Price gr. A142 (m <sup>2</sup> )	Price gr. A133 (m <sup>2</sup> )	Price gr. A133 (m <sup>2</sup> )	Price gr. A157 (m <sup>2</sup> )	Price gr. A157 (m <sup>2</sup> )	
	<b>430253H</b>	<b>430265H</b>	<b>430273H</b>	<b>430279H</b>	<b>430285H</b>	<b>430291H</b>	
	Price gr. A142 (m <sup>2</sup> )	Price gr. A142 (m <sup>2</sup> )	Price gr. A133 (m <sup>2</sup> )	Price gr. A133 (m <sup>2</sup> )	Price gr. A157 (m <sup>2</sup> )	Price gr. A157 (m <sup>2</sup> )	



Floor Tiles

30 x 30 cm



30 x 30 cm



10 x 60 cm<sup>1/2</sup>



15 x 60 cm<sup>1/2</sup>



30 x 60 cm<sup>1</sup>

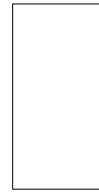

30 x 60 cm<sup>1</sup>



30 x 60 cm<sup>1</sup>

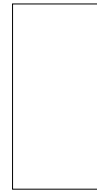

Oblong format

Oblong format

Nom. dim. - cm/in	30 x 30 / 12 x 12	30 x 30 / 12 x 12	10 x 60 / 4 x 24	15 x 60 / 6 x 24	30 x 60 / 12 x 24	30 x 60 / 12 x 24	30 x 60 / 12 x 24
Work size	297 x 297 x 10.5 mm	297 x 297 x 10.5 mm	97 x 597 x 10.5 mm	147 x 597 x 10.5 mm	297 x 597 x 10.5 mm	297 x 597 x 10.5 mm	297 x 597 x 10.5 mm
Surface	smooth, matt	smooth, matt	smooth, matt	smooth, matt	smooth, matt	smooth, matt	smooth, matt
m <sup>2</sup> - pieces	11.111	11.111	16.667	11.111	5.556	5.556	5.556
m <sup>2</sup> - kg	23.144	23.144	23.667	23.222	23.224	23.224	23.224
Bundle - pieces	11	11	15	11	6	6	6
Bundle - m <sup>2</sup>	0.990	0.990	0.900	0.990	1.080	1.080	1.080
Bundle - kg	22.913	22.913	21.300	22.990	25.080	25.080	25.080
Pallet - m <sup>2</sup>	47.520	47.520	36.000	39.600	43.197	43.197	43.197
Pallet - kg	1,099.824	1,099.824	852.012	919.600	1,003.200	1,003.200	1,003.200
Product standard	Bla	Bla	Bla	Bla	Bla	Bla	Bla
Slip resistance	R10/A	R11/B	R10/A	R10/A	R10/A	R11/B	R12/C
Stress group	3	3	2	2	2	2	2
	<b>430292H</b>	<b>430304H</b>	<i>430316H</i>	<i>430328H</i>	<b>430340H</b>	<b>430352H</b>	<b>430364H</b>
anthracite	Price gr. <b>A109</b> (m <sup>2</sup> )	Price gr. <b>A109</b> (m <sup>2</sup> )	<i>Price gr. A199</i> (m <sup>2</sup> )	<i>Price gr. A199</i> (m <sup>2</sup> )	Price gr. <b>A121</b> (m <sup>2</sup> )	Price gr. <b>A121</b> (m <sup>2</sup> )	Price gr. <b>A154</b> (m <sup>2</sup> )
	<b>430293H</b>	<b>430305H</b>	<i>430317H</i>	<i>430329H</i>	<b>430341H</b>	<b>430353H</b>	<b>430365H</b>
basalt	Price gr. <b>A109</b> (m <sup>2</sup> )	Price gr. <b>A109</b> (m <sup>2</sup> )	<i>Price gr. A199</i> (m <sup>2</sup> )	<i>Price gr. A199</i> (m <sup>2</sup> )	Price gr. <b>A121</b> (m <sup>2</sup> )	Price gr. <b>A121</b> (m <sup>2</sup> )	Price gr. <b>A154</b> (m <sup>2</sup> )
	<b>430294H</b>	<b>430306H</b>	<i>430318H</i>	<i>430330H</i>	<b>430342H</b>	<b>430354H</b>	<b>430366H</b>
pebble	Price gr. <b>A109</b> (m <sup>2</sup> )	Price gr. <b>A109</b> (m <sup>2</sup> )	<i>Price gr. A199</i> (m <sup>2</sup> )	<i>Price gr. A199</i> (m <sup>2</sup> )	Price gr. <b>A121</b> (m <sup>2</sup> )	Price gr. <b>A121</b> (m <sup>2</sup> )	Price gr. <b>A154</b> (m <sup>2</sup> )
	<b>430295H</b>	<b>430307H</b>	<i>430319H</i>	<i>430331H</i>	<b>430343H</b>	<b>430355H</b>	<b>430367H</b>
stone	Price gr. <b>A109</b> (m <sup>2</sup> )	Price gr. <b>A109</b> (m <sup>2</sup> )	<i>Price gr. A199</i> (m <sup>2</sup> )	<i>Price gr. A199</i> (m <sup>2</sup> )	Price gr. <b>A121</b> (m <sup>2</sup> )	Price gr. <b>A121</b> (m <sup>2</sup> )	Price gr. <b>A154</b> (m <sup>2</sup> )
	<b>430296H</b>	<b>430308H</b>	<i>430320H</i>	<i>430332H</i>	<b>430344H</b>	<b>430356H</b>	<b>430368H</b>
sand-white	Price gr. <b>A109</b> (m <sup>2</sup> )	Price gr. <b>A109</b> (m <sup>2</sup> )	<i>Price gr. A199</i> (m <sup>2</sup> )	<i>Price gr. A199</i> (m <sup>2</sup> )	Price gr. <b>A121</b> (m <sup>2</sup> )	Price gr. <b>A121</b> (m <sup>2</sup> )	Price gr. <b>A154</b> (m <sup>2</sup> )
	<b>430297H</b>	<b>430309H</b>	<i>430321H</i>	<i>430333H</i>	<b>430345H</b>	<b>430357H</b>	<b>430369H</b>
sand-grey	Price gr. <b>A109</b> (m <sup>2</sup> )	Price gr. <b>A109</b> (m <sup>2</sup> )	<i>Price gr. A199</i> (m <sup>2</sup> )	<i>Price gr. A199</i> (m <sup>2</sup> )	Price gr. <b>A121</b> (m <sup>2</sup> )	Price gr. <b>A121</b> (m <sup>2</sup> )	Price gr. <b>A154</b> (m <sup>2</sup> )
	<b>430298H</b>	<b>430310H</b>	<i>430322H</i>	<i>430334H</i>	<b>430346H</b>	<b>430358H</b>	<b>430370H</b>
sand	Price gr. <b>A109</b> (m <sup>2</sup> )	Price gr. <b>A109</b> (m <sup>2</sup> )	<i>Price gr. A199</i> (m <sup>2</sup> )	<i>Price gr. A199</i> (m <sup>2</sup> )	Price gr. <b>A121</b> (m <sup>2</sup> )	Price gr. <b>A121</b> (m <sup>2</sup> )	Price gr. <b>A154</b> (m <sup>2</sup> )
	<b>430299H</b>	<b>430311H</b>	<i>430323H</i>	<i>430335H</i>	<b>430347H</b>	<b>430359H</b>	<b>430371H</b>
nutmeg	Price gr. <b>A109</b> (m <sup>2</sup> )	Price gr. <b>A109</b> (m <sup>2</sup> )	<i>Price gr. A199</i> (m <sup>2</sup> )	<i>Price gr. A199</i> (m <sup>2</sup> )	Price gr. <b>A121</b> (m <sup>2</sup> )	Price gr. <b>A121</b> (m <sup>2</sup> )	Price gr. <b>A154</b> (m <sup>2</sup> )
	<b>430300H</b>	<b>430312H</b>	<i>430324H</i>	<i>430336H</i>	<b>430348H</b>	<b>430360H</b>	<b>430372H</b>
platinum	Price gr. <b>A109</b> (m <sup>2</sup> )	Price gr. <b>A109</b> (m <sup>2</sup> )	<i>Price gr. A199</i> (m <sup>2</sup> )	<i>Price gr. A199</i> (m <sup>2</sup> )	Price gr. <b>A121</b> (m <sup>2</sup> )	Price gr. <b>A121</b> (m <sup>2</sup> )	Price gr. <b>A154</b> (m <sup>2</sup> )
	<b>430301H</b>	<b>430313H</b>	<i>430325H</i>	<i>430337H</i>	<b>430349H</b>	<b>430361H</b>	<b>430373H</b>
sand-beige	Price gr. <b>A109</b> (m <sup>2</sup> )	Price gr. <b>A109</b> (m <sup>2</sup> )	<i>Price gr. A199</i> (m <sup>2</sup> )	<i>Price gr. A199</i> (m <sup>2</sup> )	Price gr. <b>A121</b> (m <sup>2</sup> )	Price gr. <b>A121</b> (m <sup>2</sup> )	Price gr. <b>A154</b> (m <sup>2</sup> )
	<b>430302H</b>	<b>430314H</b>	<i>430326H</i>	<i>430338H</i>	<b>430350H</b>	<b>430362H</b>	<b>430374H</b>
brick	Price gr. <b>A109</b> (m <sup>2</sup> )	Price gr. <b>A109</b> (m <sup>2</sup> )	<i>Price gr. A199</i> (m <sup>2</sup> )	<i>Price gr. A199</i> (m <sup>2</sup> )	Price gr. <b>A121</b> (m <sup>2</sup> )	Price gr. <b>A121</b> (m <sup>2</sup> )	Price gr. <b>A154</b> (m <sup>2</sup> )
	<b>430303H</b>	<b>430315H</b>	<i>430327H</i>	<i>430339H</i>	<b>430351H</b>	<b>430363H</b>	<b>430375H</b>
clay	Price gr. <b>A109</b> (m <sup>2</sup> )	Price gr. <b>A109</b> (m <sup>2</sup> )	<i>Price gr. A199</i> (m <sup>2</sup> )	<i>Price gr. A199</i> (m <sup>2</sup> )	Price gr. <b>A121</b> (m <sup>2</sup> )	Price gr. <b>A121</b> (m <sup>2</sup> )	Price gr. <b>A154</b> (m <sup>2</sup> )

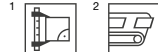

Floor Tiles

60 x 60 cm<sup>1</sup>

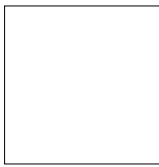

60 x 60 cm<sup>2/3/5</sup>



60 x 60 cm<sup>1</sup>

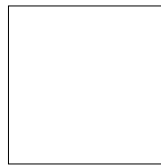

60 x 60 cm<sup>1</sup>

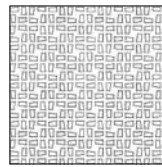

60 x 120 cm<sup>1/4/6</sup>

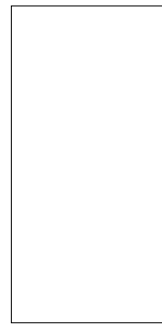

60 x 120 cm<sup>1/4/6</sup>

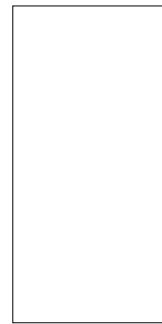

	extra thick		Grid				
	60 x 60 / 24 x 24	60 x 60 / 24 x 24	60 x 60 / 24 x 24	60 x 60 / 24 x 24	60 x 120 / 24 x 48	60 x 120 / 24 x 48	Nom. dim. - cm/in
	597 x 597 x 10.5 mm	600 x 600 x 14 mm	597 x 597 x 10.5 mm	597 x 597 x 10.5 mm	597 x 1197 x 10.5 mm	597 x 1197 x 10.5 mm	Work size
	smooth, matt	smooth, matt	smooth, matt	profiled, matt	smooth, matt	smooth, matt	Surface
	2.778	2.778	2.778	2.778	1.389	1.389	m <sup>2</sup> - pieces
	23.769	31.669	23.769	23.769	24.672	24.672	m <sup>2</sup> - kg
	3	2	3	3	2	2	Bundle - pieces
	1.080	0.720	1.080	1.080	1.440	1.440	Bundle - m <sup>2</sup>
	25.668	22.800	25.668	25.668	35.526	35.526	Bundle - kg
	38.880	30.238	38.880	38.880	43.197	43.197	Bundle - m <sup>2</sup>
	924.048	957.600	924.048	924.048	1,065.780	1,065.780	Pallet - kg
	Bla	Bla	Bla	Bla	Bla	Bla	Product standard
	R10/A	R10	R11/B	R12V4	R10/A	R11/B	Slip resistance
	3	4	3	3	2	2	Stress group
	<b>430380H</b>		<b>430214H</b>	<b>430392H</b>	<b>430398H</b>	<b>430410H</b>	anthracite <input type="checkbox"/> V2
	Price gr. <b>A136</b> (m <sup>2</sup> )		Price gr. <b>A136</b> (m <sup>2</sup> )	Price gr. <b>A166</b> (m <sup>2</sup> )	Price gr. <b>A154</b> (m <sup>2</sup> )	Price gr. <b>A154</b> (m <sup>2</sup> )	
	<b>430381H</b>		<b>430215H</b>	<b>430393H</b>	<b>430399H</b>	<b>430411H</b>	basalt <input type="checkbox"/> V2
	Price gr. <b>A136</b> (m <sup>2</sup> )		Price gr. <b>A136</b> (m <sup>2</sup> )	Price gr. <b>A166</b> (m <sup>2</sup> )	Price gr. <b>A154</b> (m <sup>2</sup> )	Price gr. <b>A154</b> (m <sup>2</sup> )	
	<b>430382H</b>	430200H	<b>430216H</b>	<b>430394H</b>	<b>430400H</b>	<b>430412H</b>	pebble <input type="checkbox"/> V2
	Price gr. <b>A136</b> (m <sup>2</sup> )		Price gr. <b>A136</b> (m <sup>2</sup> )	Price gr. <b>A166</b> (m <sup>2</sup> )	Price gr. <b>A154</b> (m <sup>2</sup> )	Price gr. <b>A154</b> (m <sup>2</sup> )	
	<b>430383H</b>				<b>430401H</b>	<b>430413H</b>	stone <input type="checkbox"/> V2
	Price gr. <b>A136</b> (m <sup>2</sup> )				Price gr. <b>A154</b> (m <sup>2</sup> )	Price gr. <b>A154</b> (m <sup>2</sup> )	
	<b>430384H</b>	430201H			<b>430402H</b>	<b>430414H</b>	sand-white <input type="checkbox"/> V2
	Price gr. <b>A136</b> (m <sup>2</sup> )				Price gr. <b>A154</b> (m <sup>2</sup> )	Price gr. <b>A154</b> (m <sup>2</sup> )	
	<b>430385H</b>	430202H	<b>430217H</b>	<b>430395H</b>	<b>430403H</b>	<b>430415H</b>	sand-grey <input type="checkbox"/> V2
	Price gr. <b>A136</b> (m <sup>2</sup> )		Price gr. <b>A136</b> (m <sup>2</sup> )	Price gr. <b>A166</b> (m <sup>2</sup> )	Price gr. <b>A154</b> (m <sup>2</sup> )	Price gr. <b>A154</b> (m <sup>2</sup> )	
	<b>430386H</b>		<b>430218H</b>	<b>430396H</b>	<b>430404H</b>	<b>430416H</b>	sand <input type="checkbox"/> V2
	Price gr. <b>A136</b> (m <sup>2</sup> )		Price gr. <b>A136</b> (m <sup>2</sup> )	Price gr. <b>A166</b> (m <sup>2</sup> )	Price gr. <b>A154</b> (m <sup>2</sup> )	Price gr. <b>A154</b> (m <sup>2</sup> )	
	<b>430387H</b>				<b>430405H</b>	<b>430417H</b>	nutmeg <input type="checkbox"/> V2
	Price gr. <b>A136</b> (m <sup>2</sup> )				Price gr. <b>A154</b> (m <sup>2</sup> )	Price gr. <b>A154</b> (m <sup>2</sup> )	
	<b>430388H</b>		<b>435576H NEW</b>	<b>435577H NEW</b>	<b>430406H</b>	<b>430418H</b>	platinum <input type="checkbox"/> V2
	Price gr. <b>A136</b> (m <sup>2</sup> )		Price gr. <b>A136</b> (m <sup>2</sup> )	Price gr. <b>A166</b> (m <sup>2</sup> )	Price gr. <b>A154</b> (m <sup>2</sup> )	Price gr. <b>A154</b> (m <sup>2</sup> )	
	<b>430389H</b>		<b>430219H</b>	<b>430397H</b>	<b>430407H</b>	<b>430419H</b>	sand-beige <input type="checkbox"/> V2
	Price gr. <b>A136</b> (m <sup>2</sup> )		Price gr. <b>A136</b> (m <sup>2</sup> )	Price gr. <b>A166</b> (m <sup>2</sup> )	Price gr. <b>A154</b> (m <sup>2</sup> )	Price gr. <b>A154</b> (m <sup>2</sup> )	
	<b>430390H</b>				<b>430408H</b>	<b>430420H</b>	brick <input type="checkbox"/> V2
	Price gr. <b>A136</b> (m <sup>2</sup> )				Price gr. <b>A154</b> (m <sup>2</sup> )	Price gr. <b>A154</b> (m <sup>2</sup> )	
	<b>430391H</b>				<b>430409H</b>	<b>430421H</b>	clay <input type="checkbox"/> V2
	Price gr. <b>A136</b> (m <sup>2</sup> )				Price gr. <b>A154</b> (m <sup>2</sup> )	Price gr. <b>A154</b> (m <sup>2</sup> )	

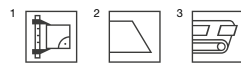

<sup>4</sup> High weight only to carry with two persons.

<sup>5</sup> Prices are calculated project-specifically.

<sup>6</sup> Important: special pallet, no return, no exchange



Floor Tile<sup>1/2/3</sup>

Cove Skirting, decorated<sup>4</sup>

Internal Corner

External Corner

90 x 90 cm

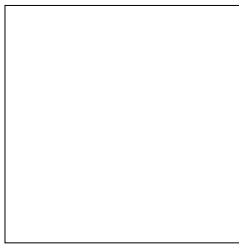

10 x 10 cm



10 x 20 cm



10 x 30 cm



10 x 60 cm



Nom. dim. - cm/in	90 x 90 / 36 x 36	10 x 10 / 4 x 4	10 x 20 / 4 x 8	10 x 30 / 4 x 12	10 x 60 / 4 x 24		
Work size	895 x 895 x 11 mm	100 x 97 x 6.5 mm	102 x 197 x 9 mm	102 x 297 x 9 mm	102 x 597 x 9 mm	102 x 20 x 9 mm	102 x 35 x 9 mm
Surface	smooth, matt	smooth, matt	smooth, matt	smooth, matt	smooth, matt	smooth, matt	smooth, matt
m <sup>2</sup> - pieces	1.234/m <sup>2</sup>	10.000/m	5.000/m	3.333/m	1.667/m		
m <sup>2</sup> - kg	24.691/m <sup>2</sup>	1.500/m	2.000/m	1.999/m	2.000/m	0.080/piece	0.080/piece
Bundle - pieces	2	40	20	16	16	18	12
Bundle - m <sup>2</sup>	1.620 m <sup>2</sup>	4.000 m	4.000 m	4.800 m	9.598 m		
Bundle - kg	40.018	6.000	8.000	9.600	19.200	1.440	0.960
Pallet - m <sup>2</sup>	48.622						
Pallet - kg	1,200.540						
Product standard	Bla	Bla	Bla	Bla	Bla	Bla	Bla
Slip resistance	R10/A	R10/B	R10/A	R10/A	R10/A		
Stress group	3						
anthracite <input type="checkbox"/>	<b>430422</b> Price gr. <b>A181</b> (m <sup>2</sup> )	<b>430564H</b> Price gr. <b>A411</b> (pce.)	<b>430428H</b> Price gr. <b>A419</b> (pce.)	<b>430440H</b> Price gr. <b>A425</b> (pce.)	<b>430452H</b> Price gr. <b>A445</b> (pce.)	<b>430480H</b> Price gr. <b>A418</b> (pce.)	<b>430492H</b> Price gr. <b>A418</b> (pce.)
basalt <input type="checkbox"/>	<b>430423</b> Price gr. <b>A181</b> (m <sup>2</sup> )	<b>430565H</b> Price gr. <b>A411</b> (pce.)	<b>430429H</b> Price gr. <b>A419</b> (pce.)	<b>430441H</b> Price gr. <b>A425</b> (pce.)	<b>430453H</b> Price gr. <b>A445</b> (pce.)	<b>430481H</b> Price gr. <b>A418</b> (pce.)	<b>430493H</b> Price gr. <b>A418</b> (pce.)
pebble <input type="checkbox"/>	<b>430424</b> Price gr. <b>A181</b> (m <sup>2</sup> )	<b>430566H</b> Price gr. <b>A411</b> (pce.)	<b>430430H</b> Price gr. <b>A419</b> (pce.)	<b>430442H</b> Price gr. <b>A425</b> (pce.)	<b>430454H</b> Price gr. <b>A445</b> (pce.)	<b>430482H</b> Price gr. <b>A418</b> (pce.)	<b>430494H</b> Price gr. <b>A418</b> (pce.)
stone <input type="checkbox"/>		<b>430567H</b> Price gr. <b>A411</b> (pce.)	<b>430431H</b> Price gr. <b>A419</b> (pce.)	<b>430443H</b> Price gr. <b>A425</b> (pce.)	<b>430455H</b> Price gr. <b>A445</b> (pce.)	<b>430483H</b> Price gr. <b>A418</b> (pce.)	<b>430495H</b> Price gr. <b>A418</b> (pce.)
sand-white <input type="checkbox"/>		<b>430568H</b> Price gr. <b>A411</b> (pce.)	<b>430432H</b> Price gr. <b>A419</b> (pce.)	<b>430444H</b> Price gr. <b>A425</b> (pce.)	<b>430456H</b> Price gr. <b>A445</b> (pce.)	<b>430484H</b> Price gr. <b>A418</b> (pce.)	<b>430496H</b> Price gr. <b>A418</b> (pce.)
sand-grey <input type="checkbox"/>	<b>430425</b> Price gr. <b>A181</b> (m <sup>2</sup> )	<b>430569H</b> Price gr. <b>A411</b> (pce.)	<b>430433H</b> Price gr. <b>A419</b> (pce.)	<b>430445H</b> Price gr. <b>A425</b> (pce.)	<b>430457H</b> Price gr. <b>A445</b> (pce.)	<b>430485H</b> Price gr. <b>A418</b> (pce.)	<b>430497H</b> Price gr. <b>A418</b> (pce.)
sand <input type="checkbox"/>	<b>430426</b> Price gr. <b>A181</b> (m <sup>2</sup> )	<b>430570H</b> Price gr. <b>A411</b> (pce.)	<b>430434H</b> Price gr. <b>A419</b> (pce.)	<b>430446H</b> Price gr. <b>A425</b> (pce.)	<b>430458H</b> Price gr. <b>A445</b> (pce.)	<b>430486H</b> Price gr. <b>A418</b> (pce.)	<b>430498H</b> Price gr. <b>A418</b> (pce.)
nutmeg <input type="checkbox"/>		<b>430571H</b> Price gr. <b>A411</b> (pce.)	<b>430435H</b> Price gr. <b>A419</b> (pce.)	<b>430447H</b> Price gr. <b>A425</b> (pce.)	<b>430459H</b> Price gr. <b>A445</b> (pce.)	<b>430487H</b> Price gr. <b>A418</b> (pce.)	<b>430499H</b> Price gr. <b>A418</b> (pce.)
platinum <input type="checkbox"/>		<b>430572H</b> Price gr. <b>A411</b> (pce.)	<b>430436H</b> Price gr. <b>A419</b> (pce.)	<b>430448H</b> Price gr. <b>A425</b> (pce.)	<b>430460H</b> Price gr. <b>A445</b> (pce.)	<b>430488H</b> Price gr. <b>A418</b> (pce.)	<b>430500H</b> Price gr. <b>A418</b> (pce.)
sand-beige <input type="checkbox"/>	<b>430427</b> Price gr. <b>A181</b> (m <sup>2</sup> )	<b>430573H</b> Price gr. <b>A411</b> (pce.)	<b>430437H</b> Price gr. <b>A419</b> (pce.)	<b>430449H</b> Price gr. <b>A425</b> (pce.)	<b>430461H</b> Price gr. <b>A445</b> (pce.)	<b>430489H</b> Price gr. <b>A418</b> (pce.)	<b>430501H</b> Price gr. <b>A418</b> (pce.)
brick <input type="checkbox"/>		<b>430574H</b> Price gr. <b>A411</b> (pce.)	<b>430438H</b> Price gr. <b>A419</b> (pce.)	<b>430450H</b> Price gr. <b>A425</b> (pce.)	<b>430462H</b> Price gr. <b>A445</b> (pce.)	<b>430490H</b> Price gr. <b>A418</b> (pce.)	<b>430502H</b> Price gr. <b>A418</b> (pce.)
clay <input type="checkbox"/>		<b>430575H</b> Price gr. <b>A411</b> (pce.)	<b>430439H</b> Price gr. <b>A419</b> (pce.)	<b>430451H</b> Price gr. <b>A425</b> (pce.)	<b>430463H</b> Price gr. <b>A445</b> (pce.)	<b>430491H</b> Price gr. <b>A418</b> (pce.)	<b>430503H</b> Price gr. <b>A418</b> (pce.)



<sup>1</sup> without Hytect coating; with Protecta upgrading

<sup>2</sup> Important: special pallet, no return, no exchange

<sup>3</sup> Color deviations compared to the adjoining covering due to production are no reason for complaint in case of horizontal laying.

For detail drawings of cove skirtings / internal corners / external corners refer to the pages 536 and the following.

### Shower Tub System<sup>1/2</sup>

10 x 10 cm



10 x 10 cm



				Strip	Corner		
				<b>10 x 10 / 4 x 4</b>	<b>10 x 10 / 4 x 4</b>	Nom. dim. - <b>cm/in</b>	
				97 x 97 x 6.5 mm	97 x 97 x 6.5 mm	Work size	
				smooth, matt	smooth, matt	Surface	
				10.000		<b>m</b> - pieces	
				1.700/m	0.170/pieces	<b>m/pce.</b> - kg	
				16	4	<b>Bundle</b> - pieces	
				1.600		<b>Bundle</b> - m	
				2.720	0.680	<b>Bundle</b> - kg	
				Bla	Bla	Product standard	
				R10/B	R10/B	Slip resistance	
				<b>430064H</b>	<b>430070H</b>	anthracite	V2
				Price gr. A445 (pce.)	Price gr. A475 (pce.)		
				<b>430065H</b>	<b>430071H</b>	basalt	V2
				Price gr. A445 (pce.)	Price gr. A475 (pce.)		
				<b>430066H</b>	<b>430072H</b>	pebble	V2
				Price gr. A445 (pce.)	Price gr. A475 (pce.)		
				<b>430067H</b>	<b>430073H</b>	sand-grey	V2
				Price gr. A445 (pce.)	Price gr. A475 (pce.)		
				<b>430068H</b>	<b>430074H</b>	sand	V2
				Price gr. A445 (pce.)	Price gr. A475 (pce.)		
				<b>430069H</b>	<b>430075H</b>	sand-beige	V2
				Price gr. A445 (pce.)	Price gr. A475 (pce.)		



<sup>2</sup> For details, refer to page 534

Stair Tiles with grooves<sup>2</sup>

Stair Tile with grooves 1/2/4

Stair Tile with bevel<sup>2/3</sup>

Stair Tile with bevel & grooves 2/3/4

Riser<sup>2/3</sup>

30 x 30 cm



30 x 60 cm<sup>1</sup>

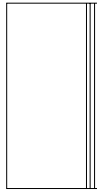

60 x 120 cm

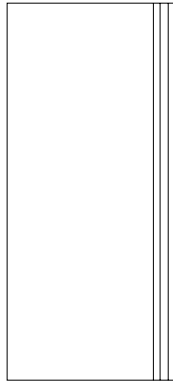

31 x 145 cm

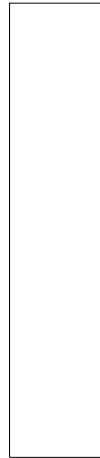

31 x 145 cm

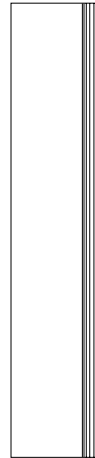

28 x 145 cm

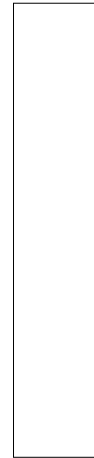

Nom. dim. - cm/in	30 x 30 / 12 x 12	30 x 60 / 12 x 24	60 x 120 / 24 x 48	31 x 145 / 12 3/8 x 58	31 x 145 / 12 3/8 x 58	28 x 145 / 11 3/16 x 58
Work size	297 x 297 x 10.5 mm	297 x 597 x 10.5 mm	597 x 1197 x 10.5 mm	307 x 1447 x 10.5 mm	307 x 1447 x 10.5 mm	280 x 1447 x 10.5 mm
Surface	smooth, matt	smooth, matt	smooth, matt	smooth, matt	smooth, matt	smooth, matt
m - pieces	3.333	1.667	0.833	0.690	0.690	0.690
m - kg	6.943	6.968	14.286	7.480	7.480	6.716
Bundle - pieces	10	6	2	2	2	2
Bundle - m	3.000	3.599	2.401	2.899	2.899	2.899
Bundle - kg	20.830	25.080	34.300	21.682	21.682	19.466
Product standard	Bla	Bla	Bla	Ala	Ala	Ala
Slip resistance	R10/A	R10/A	R10/A	R10/A	R10/A	R10/A
Stress group	3	2	2	2	2	2
anthracite	430464H Price gr. A449 (pce.)	430504H Price gr. A458 (pce.)	430398H-TF <sup>5</sup> Price gr. A593 (pce.)	435685H <sup>5</sup> Price gr. A560 (pce.)	435685H-TF <sup>5</sup> Price gr. A577 (pce.)	435695H <sup>5</sup> Price gr. A528 (pce.)
basalt	430465H Price gr. A449 (pce.)	430505H Price gr. A458 (pce.)	430399H-TF Price gr. A593 (pce.)	435686H Price gr. A560 (pce.)	435686H-TF Price gr. A577 (pce.)	435696H Price gr. A528 (pce.)
pebble	430466H Price gr. A449 (pce.)	430506H Price gr. A458 (pce.)	430400H-TF Price gr. A593 (pce.)	435687H Price gr. A560 (pce.)	435687H-TF Price gr. A577 (pce.)	435697H Price gr. A528 (pce.)
stone	430467H Price gr. A449 (pce.)	430507H Price gr. A458 (pce.)	430401H-TF Price gr. A593 (pce.)	435688H Price gr. A560 (pce.)	435688H-TF Price gr. A577 (pce.)	435698H Price gr. A528 (pce.)
sand-white	430468H Price gr. A449 (pce.)	430508H Price gr. A458 (pce.)	430402H-TF Price gr. A593 (pce.)	435689H Price gr. A560 (pce.)	435689H-TF Price gr. A577 (pce.)	435699H Price gr. A528 (pce.)
sand-grey	430469H Price gr. A449 (pce.)	430509H Price gr. A458 (pce.)	430403H-TF Price gr. A593 (pce.)	430476H Price gr. A560 (pce.)	430476H-TF Price gr. A577 (pce.)	430477H Price gr. A528 (pce.)
sand	430470H Price gr. A449 (pce.)	430510H Price gr. A458 (pce.)	430404H-TF Price gr. A593 (pce.)	435690H Price gr. A560 (pce.)	435690H-TF Price gr. A577 (pce.)	435700H Price gr. A528 (pce.)
nutmeg	430471H Price gr. A449 (pce.)	430511H Price gr. A458 (pce.)	430405H-TF Price gr. A593 (pce.)	435691H Price gr. A560 (pce.)	435691H-TF Price gr. A577 (pce.)	435701H Price gr. A528 (pce.)
platinum	430472H Price gr. A449 (pce.)	430512H Price gr. A458 (pce.)	430406H-TF Price gr. A593 (pce.)	435692H Price gr. A560 (pce.)	435692H-TF Price gr. A577 (pce.)	435702H Price gr. A528 (pce.)
sand-beige	430473H Price gr. A449 (pce.)	430513H Price gr. A458 (pce.)	430407H-TF Price gr. A593 (pce.)	435693H Price gr. A560 (pce.)	435693H-TF Price gr. A577 (pce.)	435703H Price gr. A528 (pce.)
brick	430474H Price gr. A449 (pce.)	430514H Price gr. A458 (pce.)	430408H-TF Price gr. A593 (pce.)	435694H Price gr. A560 (pce.)	435694H-TF Price gr. A577 (pce.)	435704H Price gr. A528 (pce.)
clay	430475H Price gr. A449 (pce.)	430515H Price gr. A458 (pce.)	430409H-TF <sup>5</sup> Price gr. A593 (pce.)	430212H <sup>5</sup> Price gr. A560 (pce.)	430212H-TF <sup>5</sup> Price gr. A577 (pce.)	430248H <sup>5</sup> Price gr. A528 (pce.)

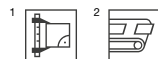

<sup>3</sup> Rectified only on the two short sides. The long side can not be rectified.

<sup>4</sup> For details, refer to page 538

<sup>5</sup> Due to production reasons, slight deviations may occur.



Stair Edges<sup>1/2/4</sup>

Stair Edge with bevel<sup>2/3/4</sup>

Skirting, rounded<sup>1</sup>

4 x 60 cm



7,2 x 60 cm



7,2 x 120 cm



7,2 x 145 cm



7 x 30 cm



7 x 60 cm



	4 x 60 / 1 5/8 x 24	7.2 x 60 / 2 7/8 x 24	7.2 x 120 / 2 7/8 x 48	7.2 x 145 / 2 7/8 x 58	7 x 30 / 2 13/16 x 12	7 x 60 / 2 13/16 x 24	Nom. dim. - cm/in
	40 x 597 x 10.5 mm	72 x 597 x 10.5 mm	72 x 1197 x 10.5 mm	72 x 1447 x 10.5 mm	70 x 297 x 10.5 mm	70 x 597 x 10.5 mm	Work size
	smooth, matt	smooth, matt	smooth, matt	smooth, matt	smooth, matt	smooth, matt	Surface
	1.667	1.667	0.833	0.690	3.333	1.667	m - pieces
	0.967	1.355	1.170	1.737	1.583	1.584	m - kg
	9	9	10	10	22	15	Bundle - pieces
	5.399	15.003	12.005	14.493	6.600	8.998	Bundle - m
	5.220	7.317	14.050	25.180	10.450	14.250	Bundle - kg
	Bla	Bla	Bla	Ala	Bla	Bla	Product standard
	R10/A	R10/A	R10/A	R10/A			Slip resistance
	2	2	2	2			Stress group
	430516H Price gr. A458 (pce.)	430340H-TK Price gr. A458 (pce.)	430398H-TK <sup>5</sup> Price gr. A511 (pce.)	435685H-TK <sup>5</sup> Price gr. A539 (pce.)	430080H Price gr. A419 (pce.)	430528H Price gr. A438 (pce.)	anthracite <input type="checkbox"/> V2
	430517H Price gr. A458 (pce.)	430341H-TK Price gr. A458 (pce.)	430399H-TK Price gr. A511 (pce.)	435686H-TK Price gr. A539 (pce.)	430081H Price gr. A419 (pce.)	430529H Price gr. A438 (pce.)	basalt <input type="checkbox"/> V2
	430518H Price gr. A458 (pce.)	430342H-TK Price gr. A458 (pce.)	430400H-TK Price gr. A511 (pce.)	435687H-TK Price gr. A539 (pce.)	430082H Price gr. A419 (pce.)	430530H Price gr. A438 (pce.)	pebble <input type="checkbox"/> V2
	430519H Price gr. A458 (pce.)	430343H-TK Price gr. A458 (pce.)	430401H-TK Price gr. A511 (pce.)	435688H-TK Price gr. A539 (pce.)	430083H Price gr. A419 (pce.)	430531H Price gr. A438 (pce.)	stone <input type="checkbox"/> V2
	430520H Price gr. A458 (pce.)	430344H-TK Price gr. A458 (pce.)	430402H-TK Price gr. A511 (pce.)	435689H-TK Price gr. A539 (pce.)	430084H Price gr. A419 (pce.)	430532H Price gr. A438 (pce.)	sand-white <input type="checkbox"/> V2
	430521H Price gr. A458 (pce.)	430345H-TK Price gr. A458 (pce.)	430403H-TK Price gr. A511 (pce.)	430476H-TK Price gr. A539 (pce.)	430085H Price gr. A419 (pce.)	430533H Price gr. A438 (pce.)	sand-grey <input type="checkbox"/> V2
	430522H Price gr. A458 (pce.)	430346H-TK Price gr. A458 (pce.)	430404H-TK Price gr. A511 (pce.)	435690H-TK Price gr. A539 (pce.)	430086H Price gr. A419 (pce.)	430534H Price gr. A438 (pce.)	sand <input type="checkbox"/> V2
	430523H Price gr. A458 (pce.)	430347H-TK Price gr. A458 (pce.)	430405H-TK Price gr. A511 (pce.)	435691H-TK Price gr. A539 (pce.)	430087H Price gr. A419 (pce.)	430535H Price gr. A438 (pce.)	nutmeg <input type="checkbox"/> V2
	430524H Price gr. A458 (pce.)	430348H-TK Price gr. A458 (pce.)	430406H-TK Price gr. A511 (pce.)	435692H-TK Price gr. A539 (pce.)	430088H Price gr. A419 (pce.)	430536H Price gr. A438 (pce.)	platinum <input type="checkbox"/> V2
	430525H Price gr. A458 (pce.)	430349H-TK Price gr. A458 (pce.)	430407H-TK Price gr. A511 (pce.)	435693H-TK Price gr. A539 (pce.)	430089H Price gr. A419 (pce.)	430537H Price gr. A438 (pce.)	sand-beige <input type="checkbox"/> V2
	430526H Price gr. A458 (pce.)	430350H-TK Price gr. A458 (pce.)	430408H-TK Price gr. A511 (pce.)	435694H-TK Price gr. A539 (pce.)	430090H Price gr. A419 (pce.)	430538H Price gr. A438 (pce.)	brick <input type="checkbox"/> V2
	430527H Price gr. A458 (pce.)	430351H-TK Price gr. A458 (pce.)	430409H-TK <sup>5</sup> Price gr. A511 (pce.)	430212H-TK <sup>5</sup> Price gr. A539 (pce.)	430091H Price gr. A419 (pce.)	430539H Price gr. A438 (pce.)	clay <input type="checkbox"/> V2

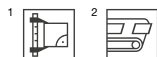

<sup>3</sup> Rectified only on the two short sides. The long side can not be rectified.

<sup>4</sup> For details, refer to page 538

<sup>5</sup> Due to production reasons, slight deviations may occur.



Guide Tiles<sup>1/2/3</sup>

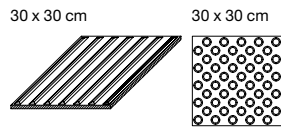

Nom. dim. - cm/in	<b>30 x 30 / 12 x 12</b>	<b>30 x 30 / 12 x 12</b>					
Work size	297 x 297 x 10.5 mm	297 x 297 x 10.5 mm					
Surface	ribbed structure	knob structure					
<b>m</b> - pieces	3.333	3.333					
<b>m</b> - kg	7.999	7.999					
<b>Bundle</b> - pieces	8	8					
<b>Bundle</b> - m	2.400	2.400					
<b>Bundle</b> - kg	19.200	19.200					
Product standard	Bla	Bla					
Slip resistance	R11	R11					
Stress group	3	3					
anthracite <span style="border: 1px solid black; padding: 0 2px;">V2</span>	<i>430304H-R</i> Price gr. A455 (pce.)	<i>430304H-N</i> Price gr. A539 (pce.)					
platinum <span style="border: 1px solid black; padding: 0 2px;">V2</span>	<i>430312H-R</i> Price gr. A455 (pce.)	<i>430312H-N</i> Price gr. A539 (pce.)					



<sup>1</sup> Complying with the requirements of DIN 32984  
<sup>2</sup> Other color combinations on request, taking into account the luminance contrast specifications from DIN 32984

Grooved Tiles, 12.5 mm thick, for  
continuing the pool edge system  
"Finland II"<sup>1/2</sup>

Gutter Tiles<sup>1/2/3</sup>

25 x 50 cm

25 x 25 cm

12,5 x 25 cm

50 x 25 cm

50 x 25 cm<sup>4</sup>

50 x 25 cm

50 x 25 cm<sup>4</sup>

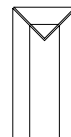
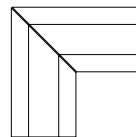
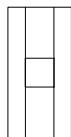
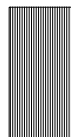

50 x 25 / 20 x 10	25 x 25 / 10 x 10	12.5 x 25 / 5 x 10	Gutter tile 50 x 25 / 20 x 10	Gutter tile with outlet 110 / 110 mm 50 x 25 / 20 x 10	Gutter tile, mitred pair 50 x 25 cm	Gutter tile, terminal piece 50 x 25 cm <sup>4</sup>	
494 x 244 x 12.5 mm	244 x 244 x 12.5 mm	119 x 244 x 12.5 mm	494 x 244 x 14 mm	494 x 244 x 14 mm	(2x) 490 x 244 x 14 mm	494 x 244 x 14 mm	Nom. dim. - cm/in
grooved, matt	grooved, matt	grooved, matt	smooth, matt	smooth, matt	smooth, matt	smooth, matt	Work size
2.000	4.000	8.000	2.000	2.000	2.000	2.000	Surface
3.550/piece	1.775/piece	0.888/piece	2.500/piece	2.300/piece	3.800/pair	2.500/piece	m - pieces
6 piece	9 piece	21 piece	5 piece	5 piece	2 pair	5 piece	pce./pair - kg
3.000	2.250	2.625	2.500	2.500	2 pair	5 piece	Bundle - pieces/pair
21.300	15.975	18.648	12.500	11.500	7.600	12.500	Bundle - m
Ala	Ala	Ala	Ala	Ala	Ala	Ala	Bundle - kg
R11/C	R11/C	R11/C	R11/B	R11/B	R11/B	R11/B	Product standard
435601H	435613H	435625H	435637H	435649H	435661H	435673H	Slip resistance
Price gr. A560 (pce.)	Price gr. A480 (pce.)	Price gr. A430 (pce.)	Price gr. A519 (pce.)	Price gr. A593 (pce.)	Price gr. A645 (pair)	Price gr. A593 (pair)	anthracite <input type="checkbox"/> V2
435602H	435614H	435626H	435638H	435650H	435662H	435674H	basalt <input type="checkbox"/> V2
Price gr. A560 (pce.)	Price gr. A480 (pce.)	Price gr. A430 (pce.)	Price gr. A519 (pce.)	Price gr. A593 (pce.)	Price gr. A645 (pair)	Price gr. A593 (pair)	pebble <input type="checkbox"/> V2
435603H	435615H	435627H	435639H	435651H	435663H	435675H	stone <input type="checkbox"/> V2
Price gr. A560 (pce.)	Price gr. A480 (pce.)	Price gr. A430 (pce.)	Price gr. A519 (pce.)	Price gr. A593 (pce.)	Price gr. A645 (pair)	Price gr. A593 (pair)	sand-white <input type="checkbox"/> V2
435604H	435616H	435628H	435640H	435652H	435664H	435676H	sand-grey <input type="checkbox"/> V2
Price gr. A560 (pce.)	Price gr. A480 (pce.)	Price gr. A430 (pce.)	Price gr. A519 (pce.)	Price gr. A593 (pce.)	Price gr. A645 (pair)	Price gr. A593 (pair)	sand <input type="checkbox"/> V2
435605H	435617H	435629H	435641H	435653H	435665H	435677H	nutmeg <input type="checkbox"/> V2
Price gr. A560 (pce.)	Price gr. A480 (pce.)	Price gr. A430 (pce.)	Price gr. A519 (pce.)	Price gr. A593 (pce.)	Price gr. A645 (pair)	Price gr. A593 (pair)	platinum <input type="checkbox"/> V2
435606H	435618H	435630H	435642H	435654H	435666H	435678H	sand-beige <input type="checkbox"/> V2
Price gr. A560 (pce.)	Price gr. A480 (pce.)	Price gr. A430 (pce.)	Price gr. A519 (pce.)	Price gr. A593 (pce.)	Price gr. A645 (pair)	Price gr. A593 (pair)	brick <input type="checkbox"/> V2
435607H	435619H	435631H	435643H	435655H	435667H	435679H	clay <input type="checkbox"/> V2
Price gr. A560 (pce.)	Price gr. A480 (pce.)	Price gr. A430 (pce.)	Price gr. A519 (pce.)	Price gr. A593 (pce.)	Price gr. A645 (pair)	Price gr. A593 (pair)	
435608H	435620H	435632H	435644H	435656H	435668H	435680H	
Price gr. A560 (pce.)	Price gr. A480 (pce.)	Price gr. A430 (pce.)	Price gr. A519 (pce.)	Price gr. A593 (pce.)	Price gr. A645 (pair)	Price gr. A593 (pair)	
435609H	435621H	435633H	435645H	435657H	435669H	435681H	
Price gr. A560 (pce.)	Price gr. A480 (pce.)	Price gr. A430 (pce.)	Price gr. A519 (pce.)	Price gr. A593 (pce.)	Price gr. A645 (pair)	Price gr. A593 (pair)	
435610H	435622H	435634H	435646H	435658H	435670H	435682H	
Price gr. A560 (pce.)	Price gr. A480 (pce.)	Price gr. A430 (pce.)	Price gr. A519 (pce.)	Price gr. A593 (pce.)	Price gr. A645 (pair)	Price gr. A593 (pair)	
435611H	435623H	435635H	435647H	435659H	435671H	435683H	
Price gr. A560 (pce.)	Price gr. A480 (pce.)	Price gr. A430 (pce.)	Price gr. A519 (pce.)	Price gr. A593 (pce.)	Price gr. A645 (pair)	Price gr. A593 (pair)	
435612H	435624H	435636H	435648H	435660H	435672H	435684H	
Price gr. A560 (pce.)	Price gr. A480 (pce.)	Price gr. A430 (pce.)	Price gr. A519 (pce.)	Price gr. A593 (pce.)	Price gr. A645 (pair)	Price gr. A593 (pair)	



<sup>2</sup> Short edge rectified

<sup>3</sup> On request, also available in a length of 497 mm.

<sup>4</sup> Minimum order quantity: 10 pieces. In case of smaller quantities, the price must be individually calculated.

Further details about the pool edge system Finland II / Gutter Tiles are to be found in the Pool + Spa programme of delivery.



Patio Tiles<sup>1/2</sup>

60 x 60 cm

60 x 60 cm

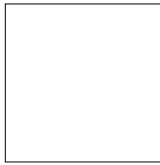

Surface decor "Square"

Nom. dim. - cm/in	60 x 60 / 24 x 24	60 x 60 / 24 x 24				
Work size	597 x 597 x 20 mm	597 x 597 x 20 mm				
Surface	smooth, matt	smooth, matt				
m <sup>2</sup> - pieces	2,778	2,778				
m <sup>2</sup> - kg	45.273	45.273				
Bundle - pieces	2	2				
Bundle - m <sup>2</sup>	0.720	0.720				
Bundle - kg	32.594	32.594				
Pallet - m <sup>2</sup>	21.598	21.598				
Pallet - kg	977.820	977.820				
Product standard	Bla	Bla				
Slip resistance	R11/B	R11/B				
Stress group	4	4				
anthracite <input type="checkbox"/> V2	<b>430093H</b> Price gr. <b>A199</b> (m <sup>2</sup> )					
basalt <input type="checkbox"/> V2	<b>430094H</b> Price gr. <b>A199</b> (m <sup>2</sup> )					
basalt <input type="checkbox"/> V3		<b>430115H</b> Price gr. <b>A199</b> (m <sup>2</sup> )				
pebble <input type="checkbox"/> V2	<b>430095H</b> Price gr. <b>A199</b> (m <sup>2</sup> )					
sand-grey <input type="checkbox"/> V2	<b>430096H</b> Price gr. <b>A199</b> (m <sup>2</sup> )					
sand-grey <input type="checkbox"/> V3		<b>430116H</b> Price gr. <b>A199</b> (m <sup>2</sup> )				
sand <input type="checkbox"/> V2	<b>430097H</b> Price gr. <b>A199</b> (m <sup>2</sup> )					
sand-beige <input type="checkbox"/> V2	<b>430098H</b> Price gr. <b>A199</b> (m <sup>2</sup> )					
sand-beige <input type="checkbox"/> V3		<b>430117H</b> Price gr. <b>A199</b> (m <sup>2</sup> )				



<sup>2</sup> High weight only to carry with two persons.

### Special Pieces – Patio Tiles<sup>1</sup>

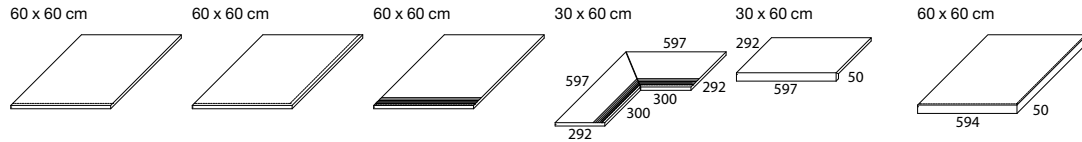

<i>Patio tile with rounded edge on one side</i>	<i>Patio tile with corneradjacent rounded edges</i>	<i>Patio tile with rounded edge on one side and grooves</i>	<i>Patio tile with rounded edge on one side and grooves as corner solution (2 pieces)</i>	<i>Patio tile step with nosing</i>	<i>Patio tile step with nosing as corner solution</i>	
<b>60 x 60 / 24 x 24</b>	<b>60 x 60 / 24 x 24</b>	<b>60 x 60 / 24 x 24</b>	<b>30 x 60 / 12 x 24</b>	<b>30 x 60 / 12 x 24</b>	<b>60 x 60 / 24 x 24</b>	Nom. dim. - <b>cm/in</b>
597 x 597 x 20 mm	597 x 597 x 20 mm	597 x 597 x 20 mm	292 x 597 x 20 mm	292/50 x 597 x 20 mm	594/50 x 594 x 20 mm	Work size
smooth, matt	smooth, matt	smooth, matt	smooth, matt	smooth, matt	smooth, matt	Surface
1.667	1.667	1.667	1.667	1.667		<b>m</b> - pieces
27.167/m	27.167/m	27.167/m	16.297/pair	15.868/m		<b>m/pair</b> - kg
1 piece	1 piece	1 piece	1 pair	1 piece	1 piece	<b>Bundle</b> - pieces/pair
0.600	0.600	0.600				<b>Bundle</b> - m
16.297	16.297	16.297	16.297	9.519	19.027	<b>Bundle</b> - kg
						<b>Pallet</b> - m
Bla	Bla	Bla	Bla	Bla	Bla	<b>Pallet</b> - kg
R11/B	R11/B	R11/B	R11/B	R11/B	R11/B	Product standard
4	4	4	4	4	4	Slip resistance
<b>430093H-RE</b>	<b>430093H-RZ</b>	<b>430093H-RER</b>	<b>430093H-RERZ</b>	<b>430093H-SE</b>	<b>430093H-SZ</b>	Stress group
<i>Price gr. A672 (pce.)</i>	<i>Price gr. A731 (pce.)</i>	<i>Price gr. A689 (pce.)</i>	<i>Price gr. A792 (pce.)</i>	<i>Price gr. A689 (pce.)</i>	<i>Price gr. A784 (pce.)</i>	anthracite <span style="border: 1px solid black; padding: 2px;">V2</span>



Other versions regarding edge formation and/or formats possible on request.

Minimum order quantity: 10 linear metres per order (division into several articles possible), smaller quantities after separate price calculation.







## Play with movement and transparency

The Aruba series is puristic, harmonious and ideal for private bathrooms. In warm white colors and sandy shades, it is available as a wall tile and a Kentia decorative tile with palm leaf motifs. The decorative tiles can be arranged as freely and can be installed in any direction. They are available in oblong format. This, along with their unique tile pattern, offers unlimited visual freedom during installation. It also makes the filigree rhythm of the tile pattern possible and particularly emphasizes the movement of the leaves. The floor tiles complete the range, also in the particularly representative size of 60 x 120 cm and in the visually appealing mosaic format. The Hytect surface makes the entire series easy to clean, offering antibacterial protection and ensuring hygienic cleanliness.

Rendering

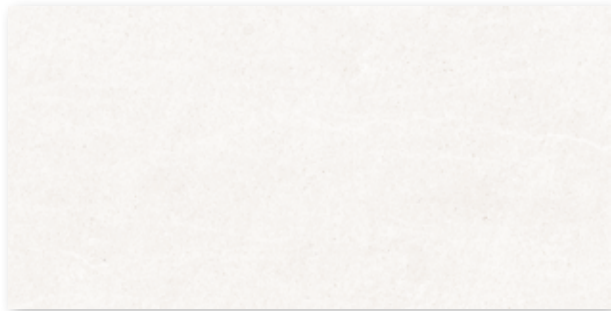

Wall tile 30 x 60 cm, 12 x 24 in, white, smooth

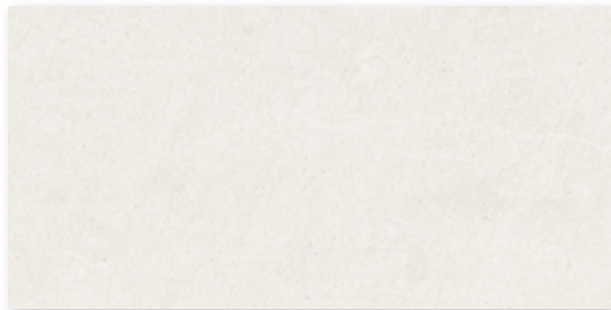

Wall tile 30 x 60 cm, 12 x 24 in, sand, smooth

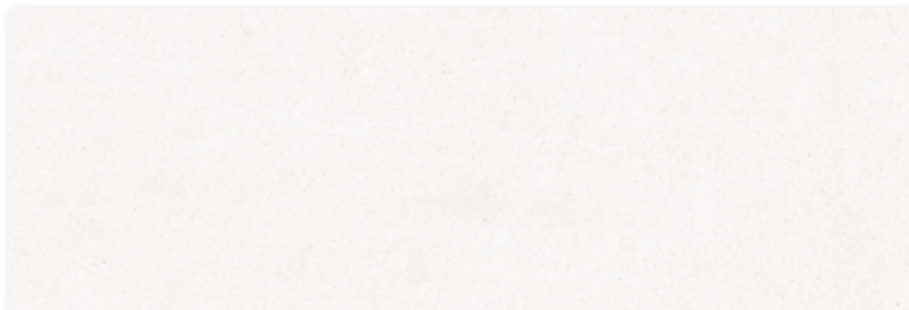

Wall tile 30 x 90 cm, 12 x 36 in, white, smooth



Wall tile 30 x 90 cm, 12 x 36 in, sand, smooth



## Decoration Elements



Decorative tile Kentia 30 x 60 cm, 12 x 24 in, sand white, smooth



Decorative tile Kentia 30 x 90 cm, 12 x 36 in, sand white, smooth

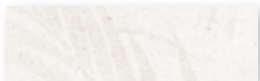

Oblong format Kentia 7.5 x 25 cm, 3 x 20 in,  
sand white, smooth



pearl



mud



stone

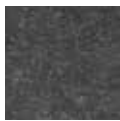

graphite



Floor tile 30 x 60 cm, 12 x 24 in, structured, R9



Floor tile 60 x 60 cm, 24 x 24 in, structured, R9



Floor tile 60 x 120 cm, 24 x 48 in, structured, R9



Stair tile 30 x 60 cm (with grooves), 12 x 24 in, structured, R9



Skirting, rounded 7 x 60 cm, 2 13/16 x 24 in, structured

Wall Tiles

Decoration Elements<sup>2</sup>

30 x 60 cm



30 x 90 cm<sup>1</sup>

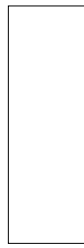

30 x 60 cm



30 x 90 cm<sup>1</sup>



7,5 x 25 cm



	<i>Decorative tile Kentia</i>		<i>Decorative tile Kentia</i>		<i>Oblong format Kentia</i>	
Nom. dim - cm/in	<b>30 x 60</b> / 12 x 24	<b>30 x 90</b> / 12 x 36	<b>30 x 60</b> / 12 x 24	<b>30 x 90</b> / 12 x 36	<b>7.5 x 25</b> / 3 1/8 x 10	
Work size	297 x 597 x 6 mm	297 x 897 x 6 mm	297 x 597 x 6 mm	297 x 897 x 6 mm	72 x 247 x 6 mm	
Surface	smooth, silky-matt	smooth, silky-matt	smooth, silky-matt	smooth, silky-matt	smooth, silky-matt	
m <sup>2</sup> - pieces	5.556	3.704	5.556	3.704	53.333	
m <sup>2</sup> - kg	10.279	10.400	10.279	10.400	9.813	
Bundle - pieces	13	8	13	8	18	
Bundle - m <sup>2</sup>	2.340	2.160	2.340	2.160	0.338	
Bundle - kg	24.050	22.464	24.050	22.464	3.123	
Pallet - m <sup>2</sup>	112.311	51.836	112.311	51.836	56.700	
Pallet - kg	1,154.400	539.136	1,154.400	539.136	556.416	
Product standard	BIII	BIII	BIII	BIII	BIII	
white	<b>203225H</b> Price gr. <b>C68</b> (m <sup>2</sup> )	<b>323227H</b> Price gr. <b>C134</b> (m <sup>2</sup> )				
sand	<b>203226H</b> Price gr. <b>C68</b> (m <sup>2</sup> )	<b>323228H</b> Price gr. <b>C134</b> (m <sup>2</sup> )				
sand white			<b>203229H</b> Price gr. <b>C77</b> (m <sup>2</sup> )	<b>323230H</b> Price gr. <b>C143</b> (m <sup>2</sup> )	<b>203333H</b> Price gr. <b>C218</b> (m <sup>2</sup> )	



<sup>2</sup> Decoration elements only available in full boxes.

Floor Tiles<sup>1</sup>

Stair  
Tile<sup>1/2</sup>

Skirting,  
rounded<sup>1</sup>

30 x 60 cm

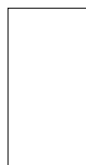

60 x 60 cm

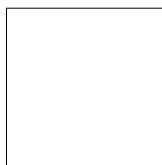

60 x 120 cm



30 x 60 cm



7 x 60 cm<sup>1</sup>



	30 x 60 / 12 x 24	60 x 60 / 24 x 24	60 x 120 / 24 x 48	30 x 60 / 12 x 24	7 x 60 / 2 13/16 x 24	Nom. dim - cm/in
	297 x 597 x 8 mm	597 x 597 x 8 mm	597 x 1197 x 8 mm	297 x 597 x 8 mm	70 x 597 x 8 mm	Work size
	structured, matt	structured, matt	structured, matt	structured, matt	structured, matt	Surface
	5.556/m <sup>2</sup>	2.778/m <sup>2</sup>	1.388/m <sup>2</sup>	1.667/m	1.667/m	m <sup>2</sup> - pieces
	17.413/m <sup>2</sup>	18.001/m <sup>2</sup>	17.489/m <sup>2</sup>	5.224/m	1.219/m	m <sup>2</sup> - kg
	6	4	2	6	15	Bundle - pieces
	1.080/m <sup>2</sup>	1.440/m <sup>2</sup>	1.441/m <sup>2</sup>	3.599/m	8.998/m	Bundle - m <sup>2</sup>
	18.804	25.920	25.200	18.804	10.969	Bundle - kg
	43.197	43.197	36.023			Pallet - m <sup>2</sup>
	752.160	777.600	630.000			Pallet - kg
	Alb	Alb	Alb	Alb	Alb	Product standard
	R9	R9	R9	R9		Slip resistance
	2	2	2	2		Stress group
	<b>430834H</b>	<b>430838H</b>	<b>430842H</b>	<b>430846H</b>	<b>430850H</b>	pearl <input type="checkbox"/> V3
	Price gr. C122 (m <sup>2</sup> )	Price gr. C137 (m <sup>2</sup> )	Price gr. C161 (m <sup>2</sup> )	Price gr. C466 (pce.)	Price gr. C440 (pce.)	mud <input type="checkbox"/> V3
	<b>430835H</b>	<b>430839H</b>	<b>430843H</b>	<b>430847H</b>	<b>430851H</b>	stone <input type="checkbox"/> V3
	Price gr. C122 (m <sup>2</sup> )	Price gr. C137 (m <sup>2</sup> )	Price gr. C161 (m <sup>2</sup> )	Price gr. C466 (pce.)	Price gr. C440 (pce.)	graphite <input type="checkbox"/> V3
	<b>430836H</b>	<b>430840H</b>	<b>430844H</b>	<b>430848H</b>	<b>430797H</b>	
	Price gr. C122 (m <sup>2</sup> )	Price gr. C137 (m <sup>2</sup> )	Price gr. C161 (m <sup>2</sup> )	Price gr. C466 (pce.)	Price gr. C440 (pce.)	
	<b>430837H</b>	<b>430841H</b>	<b>430845H</b>	<b>430849H</b>	<b>430798H</b>	
	Price gr. C122 (m <sup>2</sup> )	Price gr. C137 (m <sup>2</sup> )	Price gr. C161 (m <sup>2</sup> )	Price gr. C466 (pce.)	Price gr. C440 (pce.)	

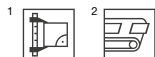





## Experience diversity

Ascona is made for spas, wellness areas and swimming pools in hotels, but also for private homes. This stems from the versatility of the series. Visually, the series offers mosaics and oblong formats, small and large sizes for walls and floors, and a refined selection of colors, providing a wide range of design possibilities. The series also stands out for its functional versatility and technical solutions, making it ideal for all swimming pool areas or spas—both indoors and outdoors, in entrance areas, and spaces where visitors walk barefoot or in dedicated wet areas. With its clean lines and grounded colors, a wide variety of style worlds can be created. The series accommodates both minimalist architecture and classic or modern country house designs. The Ascona series can be perfectly combined with our mosaic series Marble & More.

Rendering



R10/A R10/B R11/B R11/C



pearl



mud



stone

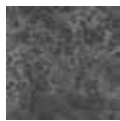

graphite



shell



sand



Floor tile 15 x 15 cm, 6 x 6 in, structured, R10/B



Floor tile 25 x 50 cm, 10 x 20 in, structured, R11/B



Floor tile 30 x 60 cm, 12 x 24 in, structured, R10/A  
Floor tile 30 x 60 cm, 12 x 24 in, structured, R11/B



Grid profile tile 25 x 50 cm, 10 x 20 in, relief, R11/C

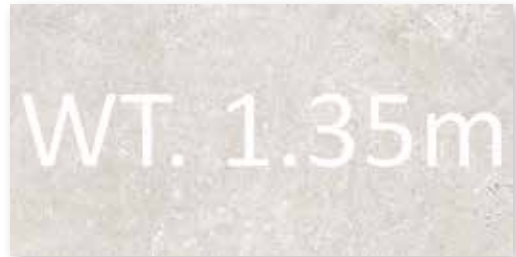

Letter tile 25 x 50 cm, 10 x 20 in, structured, R11/B

### Mosaic 5 x 5 cm, 2 x 2 in



Mosaic sheet 30 x 30 cm, 12 x 12 in, pearl, structured, R10/B



Mosaic sheet 30 x 30 cm, 12 x 12 in, mud, structured, R10/B



Mosaic sheet 30 x 30 cm, 12 x 12 in, stone, structured, R10/B



Mosaic sheet 30 x 30 cm, 12 x 12 in, graphite, structured, R10/B



Mosaic sheet 30 x 30 cm, 12 x 12 in, shell, structured, R10/B



Mosaic sheet 30 x 30 cm, 12 x 12 in, sand, structured, R10/B



Mosaics glued thermoplastically on back of Agrob Buchtal can be used not only in dry zones but also without any problems in underwater areas (e.g. swimming pools/whirlpools) as well as in permanently wet areas (e.g. pool surrounds/showers).





Floor tile 60 x 60 cm, 24 x 24 in, structured, R10/A  
Floor tile 60 x 60 cm, 24 x 24 in, structured, R11/B



Cove skirting 10 x 50 cm, 4 x 20 in, structured, R10/A



Cove skirting 10 x 60 cm, 4 x 24 in, structured, R10/A



Skirting, cut, 6 x 50 cm, 2 3/8 x 20 in



Skirting, cut, 6 x 60 cm, 2 3/8 x 24 in



Stair tile with bevel and grooves, 31 x 145 cm, 12.4 x 58 in, structured, R10/A



Stair tile with bevel 31 x 145 cm, 12.4 x 58 in, structured, R10/A



Riser 28 x 145 cm, 11.2 x 58 in, structured, R10/A



### Grid profile



pearl



mud



stone

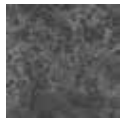

graphite



shell

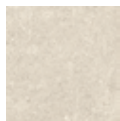

sand



Floor tile 12.5 x 12.5 cm, 5 x 5 in, structured, R11/B



Floor tile 12.5 x 25 cm, 5 x 10 in, structured, R11/B



Floor tile 25 x 25 cm, 10 x 10 in, structured, R11/B



Floor tile 25 x 50 cm, 10 x 20 in, structured, R11/B

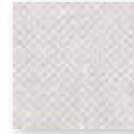

Grid profile tile 12.5 x 12.5 cm, 5 x 5 in, relief, R11/C

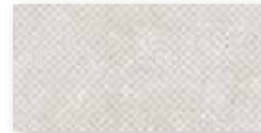

Grid profile tile 12.5 x 25 cm, 5 x 10 in, relief, R11/C



Grid profile tile 25 x 25 cm, 10 x 10 in, relief, R11/C



Grid profile tile 25 x 50 cm, 10 x 20 in, relief, R11/C



Wall tile 12.5 x 25 cm, 5 x 10 in, structured



Wall tile 25 x 50 cm, 10 x 20 in, structured



Grooved tile 12.5 x 25 cm,  
5 x 10 in, grooved, R11/C



Grooved tile 25 x 25 cm,  
10 x 10 in, grooved, R11/C



Grooved tile 50 x 25 cm, 10 x 20 in,  
grooved, R11/C



Cove skirting 10 x 25 cm, 4 x 10 in, structured, R10/A

### Gutter tile (trough depth 5 mm)



Gutter tile, 50 x 25 cm, 20 x 10 in,  
structured, R11/B



Gutter tile, mitred pair  
structured, R11/B



Gutter tile with outlet  
structured, R11/B



Terminal piece  
structured, R11/B

For details concerning gutter tiles, refer to the Pool + Spa programme of delivery.



pearl



mud



stone

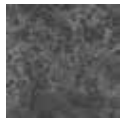

graphite



sand



Patio tile 50 x 100 cm, 20 x 40 in, structured, R11/B

Floor Tiles – joint 3 mm

Mosaic<sup>1</sup>

5 x 5 cm



Floor Tiles

15 x 15 cm



25 x 50 cm<sup>2</sup>

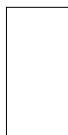

25 x 50 cm<sup>2/3</sup>



30 x 60 cm<sup>2</sup>



30 x 60 cm<sup>2</sup>



Sheet: 297 x 297 mm

Grid profile tile

	5 x 5 / 2 x 2	15 x 15 / 6 x 6	25 x 50 / 10 x 20	25 x 50 / 10 x 20	30 x 60 / 12 x 24	30 x 60 / 12 x 24	Nom. dim. - cm/in
	47 x 47 x 6.5 mm	147 x 147 x 8 mm	247 x 497 x 8 mm	247 x 497 x 8 mm	297 x 597 x 8 mm	297 x 597 x 8 mm	Work size
	structured, matt	structured, matt	structured, matt	relief, matt	structured, matt	structured, matt	Surface
	11 sheets	44.444	8.000	8.000	5.556	5.556	m <sup>2</sup> - pieces
	12.331	17.555	17.040	17.040	17.413	17.413	m <sup>2</sup> - kg
	11	35	9	9	6	6	Bundle - pieces
	1.000	0.788	1.125	1.125	1.080	1.080	Bundle - m <sup>2</sup>
	12.331	13.825	19.170	19.170	18.804	18.804	Bundle - kg
	64.000	63.001	40.500	40.500	43.197	43.197	Pallet - m <sup>2</sup>
	789.184	1,106.000	690.120	690.120	752.160	752.160	Pallet - kg
	Bla	Bla	Ala	Ala	Ala	Ala	Product standard
	R10/B	R10/B	R11/B	R11/C	R10/A	R11/B	Slip resistance
	1	2	2	2	2	2	Stress group
	<b>430701H</b>	<b>430705H</b>	<b>430709H</b>	<i>430713H</i>	<b>430721H</b>	<b>430725H</b>	
	Price gr. <b>A226</b> (m <sup>2</sup> )	Price gr. <b>A154</b> (m <sup>2</sup> )	Price gr. <b>A166</b> (m <sup>2</sup> )	Price gr. <b>A187</b> (m <sup>2</sup> )	Price gr. <b>A124</b> (m <sup>2</sup> )	Price gr. <b>A142</b> (m <sup>2</sup> )	pearl <input type="checkbox"/> V3
	<b>430702H</b>	<b>430706H</b>	<b>430710H</b>	<i>430714H</i>	<b>430722H</b>	<b>430726H</b>	mud <input type="checkbox"/> V3
	Price gr. <b>A226</b> (m <sup>2</sup> )	Price gr. <b>A154</b> (m <sup>2</sup> )	Price gr. <b>A166</b> (m <sup>2</sup> )	Price gr. <b>A187</b> (m <sup>2</sup> )	Price gr. <b>A124</b> (m <sup>2</sup> )	Price gr. <b>A142</b> (m <sup>2</sup> )	stone <input type="checkbox"/> V3
	<b>430703H</b>	<b>430707H</b>	<b>430711H</b>	<i>430715H</i>	<b>430723H</b>	<b>430727H</b>	
	Price gr. <b>A226</b> (m <sup>2</sup> )	Price gr. <b>A154</b> (m <sup>2</sup> )	Price gr. <b>A166</b> (m <sup>2</sup> )	Price gr. <b>A187</b> (m <sup>2</sup> )	Price gr. <b>A124</b> (m <sup>2</sup> )	Price gr. <b>A142</b> (m <sup>2</sup> )	graphite <input type="checkbox"/> V3
	<b>430704H</b>	<b>430708H</b>	<b>430712H</b>	<i>430716H</i>	<b>430724H</b>	<b>430728H</b>	
	Price gr. <b>A226</b> (m <sup>2</sup> )	Price gr. <b>A154</b> (m <sup>2</sup> )	Price gr. <b>A166</b> (m <sup>2</sup> )	Price gr. <b>A187</b> (m <sup>2</sup> )	Price gr. <b>A124</b> (m <sup>2</sup> )	Price gr. <b>A142</b> (m <sup>2</sup> )	shell <input type="checkbox"/> V3
	<b>431501H</b>	<b>431503H</b>	<b>431505H</b>	<i>431507H</i>	<b>431509H</b>	<b>431511H</b>	
	Price gr. <b>A226</b> (m <sup>2</sup> )	Price gr. <b>A154</b> (m <sup>2</sup> )	Price gr. <b>A166</b> (m <sup>2</sup> )	Price gr. <b>A187</b> (m <sup>2</sup> )	Price gr. <b>A124</b> (m <sup>2</sup> )	Price gr. <b>A142</b> (m <sup>2</sup> )	shell <input type="checkbox"/> V3
	<b>431502H</b>	<b>431504H</b>	<b>431506H</b>	<i>431508H</i>	<b>431510H</b>	<b>431512H</b>	
	Price gr. <b>A226</b> (m <sup>2</sup> )	Price gr. <b>A154</b> (m <sup>2</sup> )	Price gr. <b>A166</b> (m <sup>2</sup> )	Price gr. <b>A187</b> (m <sup>2</sup> )	Price gr. <b>A124</b> (m <sup>2</sup> )	Price gr. <b>A142</b> (m <sup>2</sup> )	sand <input type="checkbox"/> V3



Floor Tiles – joint 3 mm

Floor Tiles<sup>1</sup>

Stair Tile with bevel and grooves<sup>2/3/4</sup>

Stair Tile with bevel<sup>2/3/4</sup>

Riser<sup>2/3/4</sup>

60 x 60 cm

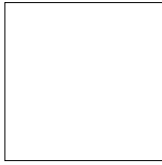

60 x 60 cm

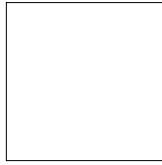

31 x 145 cm

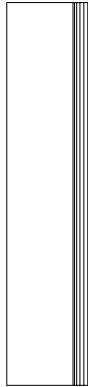

31 x 145 cm



28 x 145 cm



Nom. dim. - cm/in	60 x 60 / 24 x 24	60 x 60 / 24 x 24	31 x 145 / 12 3/8 x 58	31 x 145 / 12 3/8 x 58	28 x 145 / 11 3/16 x 58		
Work size	597 x 597 x 8 mm	597 x 597 x 8 mm	307 x 1447 x 10.5 mm	307 x 1447 x 10.5 mm	280 x 1447 x 10.5 mm		
Surface	structured, matt	structured, matt	structured, matt	structured, matt	structured, matt		
m <sup>2</sup> /m - pieces	2.778/m <sup>2</sup>	2.778/m <sup>2</sup>	0.690/m	0.690/m	0.690/m		
m <sup>2</sup> /m - kg	18.001/m <sup>2</sup>	18.001/m <sup>2</sup>	7.480/m	7.480/m	6.716/m		
Bundle - pieces	4	4	2	2	2		
Bundle - m <sup>2</sup> /m	1.440 m <sup>2</sup>	1.440 m <sup>2</sup>	2.899 m	2.899 m	2.899 m		
Bundle - kg	25.920	25.920	21.682	21.682	19.466		
Pallet - m <sup>2</sup>	43.197	43.197					
Pallet - kg	777.600	777.600					
Product standard	Ala	Ala	Ala	Ala	Ala		
Slip resistance	R10/A	R11/B	R10/A	R10/A	R10/A		
Stress group	2	2	2	2	2		
pearl	<b>430729H</b> Price gr. <b>A136</b> (m <sup>2</sup> )	<b>430733H</b> Price gr. <b>A151</b> (m <sup>2</sup> )	<i>431576H-TF</i> Price gr. <i>A577</i> (pce.)	<i>431576H</i> Price gr. <i>A560</i> (pce.)	<i>431582H</i> Price gr. <i>A528</i> (pce.)		
mud	<b>430730H</b> Price gr. <b>A136</b> (m <sup>2</sup> )	<b>430734H</b> Price gr. <b>A151</b> (m <sup>2</sup> )	<i>431577H-TF</i> Price gr. <i>A577</i> (pce.)	<i>431577H</i> Price gr. <i>A560</i> (pce.)	<i>431583H</i> Price gr. <i>A528</i> (pce.)		
stone	<b>430731H</b> Price gr. <b>A136</b> (m <sup>2</sup> )	<b>430735H</b> Price gr. <b>A151</b> (m <sup>2</sup> )	<i>431578H-TF</i> Price gr. <i>A577</i> (pce.)	<i>431578H</i> Price gr. <i>A560</i> (pce.)	<i>431584H</i> Price gr. <i>A528</i> (pce.)		
graphite	<b>430732H</b> Price gr. <b>A136</b> (m <sup>2</sup> )	<b>430736H</b> Price gr. <b>A151</b> (m <sup>2</sup> )	<i>431579H-TF</i> Price gr. <i>A577</i> (pce.)	<i>431579H</i> Price gr. <i>A560</i> (pce.)	<i>431585H</i> Price gr. <i>A528</i> (pce.)		
shell	<b>431513H</b> Price gr. <b>A136</b> (m <sup>2</sup> )	<b>431515H</b> Price gr. <b>A151</b> (m <sup>2</sup> )	<i>431580H-TF</i> Price gr. <i>A577</i> (pce.)	<i>431580H</i> Price gr. <i>A560</i> (pce.)	<i>431586H</i> Price gr. <i>A528</i> (pce.)		
sand	<b>431514H</b> Price gr. <b>A136</b> (m <sup>2</sup> )	<b>431516H</b> Price gr. <b>A151</b> (m <sup>2</sup> )	<i>431581H-TF</i> Price gr. <i>A577</i> (pce.)	<i>431581H</i> Price gr. <i>A560</i> (pce.)	<i>431587H</i> Price gr. <i>A528</i> (pce.)		

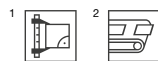

<sup>3</sup> Rectified only on the two short sides. The long side can not be rectified.

<sup>4</sup> For details, refer to page 538. For more solutions concerning stair design, refer to the series Area Pro.

Cove Skirting,  
decorated<sup>1/2/7</sup>

10 x 50 cm



10 x 60 cm

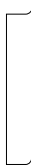

Skirting, cut<sup>1</sup>

6 x 50 cm



6 x 60 cm



Letter Tile<sup>1/2/3</sup>

25 x 50 cm

WT. 1.35m



Type height 7 cm

	10 x 50 / 4 x 20	10 x 60 / 4 x 24	6 x 50 / 2 3/8 x 20	6 x 60 / 2 3/8 x 24	25 x 50 / 10 x 20	
	100 x 497/35 x 9 mm	100 x 597/35 x 9 mm	60 x 497 x 8 mm	60 x 597 x 8 mm	247 x 497 x 8 mm	Nom. dim. - cm/in
	structured, matt	structured, matt	structured, matt	structured, matt	structured, matt	Work size
	2.000	1.667	2.000	1.667	2.000	Surface
	2.000/m	2.000/m	1.098/m	1.100/m	2.130/piece	m - pieces
	20	20	30	34		m/pc. - kg
	10.000	11.998	15.000	20.396		Bundle - pieces
	20.000	24.000	16.470	22.440		Bundle - m
						Bundle - kg
						Pallet - m <sup>2</sup>
						Pallet - kg
	Alb	Alb	Ala	Ala	Ala	Product standard
	R10/A	R10/A			R11/B	Slip resistance
					2	Stress group
	430741H <sup>6</sup>	430737H <sup>6</sup>	430984H	430988H	430717H	pearl <input type="checkbox"/> V3
	Price gr. A441 (pce.)	Price gr. A445 (pce.)	Price gr. A434 (pce.)	Price gr. A434 (pce.)	Price gr. A668 (pce.)	
	430742H <sup>5</sup>	430738H <sup>5</sup>	430985H	430989H	430718H	mud <input type="checkbox"/> V3
	Price gr. A441 (pce.)	Price gr. A445 (pce.)	Price gr. A434 (pce.)	Price gr. A434 (pce.)	Price gr. A668 (pce.)	
	430743H <sup>6</sup>	430739H <sup>6</sup>	430986H	430990H	430719H	stone <input type="checkbox"/> V3
	Price gr. A441 (pce.)	Price gr. A445 (pce.)	Price gr. A434 (pce.)	Price gr. A434 (pce.)	Price gr. A668 (pce.)	
	430744H <sup>4</sup>	430740H <sup>4</sup>	430987H	430991H	430720H	graphite <input type="checkbox"/> V3
	Price gr. A441 (pce.)	Price gr. A445 (pce.)	Price gr. A434 (pce.)	Price gr. A434 (pce.)	Price gr. A668 (pce.)	
	431523H <sup>6</sup>	431525H <sup>6</sup>	431527H	431529H	431531H	shell <input type="checkbox"/> V3
	Price gr. A441 (pce.)	Price gr. A445 (pce.)	Price gr. A434 (pce.)	Price gr. A434 (pce.)	Price gr. A668 (pce.)	
	431524H <sup>6</sup>	431526H <sup>6</sup>	431528H	431530H	431532H	sand <input type="checkbox"/> V3
	Price gr. A441 (pce.)	Price gr. A445 (pce.)	Price gr. A434 (pce.)	Price gr. A434 (pce.)	Price gr. A668 (pce.)	

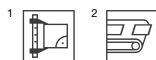

<sup>3</sup> Only figures/letters in color 91 are available (neutral 10 / active white).

<sup>4</sup> Stress group: 2

<sup>5</sup> Stress group: 3

<sup>6</sup> Stress group: 4

<sup>7</sup> Color deviations compared to the adjoining covering due to production are no reason for complaint in case of horizontal laying.



Wall and Floor Tiles – joint 6 mm

Wall Tile

Floor Tiles

12,5 x 25 cm



12,5 x 12,5 cm<sup>2</sup>



12,5 x 12,5 cm<sup>1/2</sup>



12,5 x 25 cm



12,5 x 25 cm<sup>1</sup>



25 x 25 cm



25 x 25 cm<sup>1</sup>



Grid profile tile

Grid profile tile

Grid profile tile

Nom. dim. - cm/in	12.5 x 25 / 5 x 10	12.5 x 12.5 / 5 x 5	12.5 x 12.5 / 5 x 5	12.5 x 25 / 5 x 10	12.5 x 25 / 5 x 10	25 x 25 / 10 x 10	25 x 25 / 10 x 10
Work size	119 x 244 x 8 mm	119 x 119 x 8 mm	119 x 119 x 8 mm	119 x 244 x 8 mm	119 x 244 x 8 mm	244 x 244 x 8 mm	244 x 244 x 8 mm
Surface	structured, matt	structured, matt	relief, matt	structured, matt	relief, matt	structured, matt	relief, matt
m <sup>2</sup> - pieces	32.000	64.000	64.000	32.000	32.000	16.000	16.000
m <sup>2</sup> - kg	15.680	15.360	15.360	15.680	15.680	16.960	16.960
Bundle - pieces	33	66	66	33	33	14	14
Bundle - m <sup>2</sup>	1.031	1.031	1.031	1.031	1.031	0.875	0.875
Bundle - kg	16.170	15.840	15.840	16.170	16.170	14.840	14.840
Pallet - m <sup>2</sup>	86.625	86.625	86.625	86.625	86.625	70.875	70.875
Pallet - kg	1,358.280	1,330.560	1,330.560	1,358.280	1,358.280	1,202.040	1,202.040
Product standard	Ala	Ala	Ala	Ala	Ala	Ala	Ala
Slip resistance	-	R11/B	R11/C	R11/B	R11/C	R11/B	R11/C
Stress group	2	2	2	2	2	2	2
pearl	<b>430761H</b> Price gr. <b>A127</b> (m <sup>2</sup> )	<b>430753H</b> Price gr. <b>A166</b> (m <sup>2</sup> )	<i>430757H</i> <i>Price gr. A166 (m<sup>2</sup>)</i>	<b>430763H</b> Price gr. <b>A136</b> (m <sup>2</sup> )	<i>430767H</i> <i>Price gr. A148 (m<sup>2</sup>)</i>	<b>430771H</b> Price gr. <b>A175</b> (m <sup>2</sup> )	<i>430775H</i> <i>Price gr. A142 (m<sup>2</sup>)</i>
mud		<b>430754H</b> Price gr. <b>A166</b> (m <sup>2</sup> )	<i>430758H</i> <i>Price gr. A166 (m<sup>2</sup>)</i>	<b>430764H</b> Price gr. <b>A136</b> (m <sup>2</sup> )	<i>430768H</i> <i>Price gr. A148 (m<sup>2</sup>)</i>	<b>430772H</b> Price gr. <b>A175</b> (m <sup>2</sup> )	<i>430776H</i> <i>Price gr. A142 (m<sup>2</sup>)</i>
stone		<b>430755H</b> Price gr. <b>A166</b> (m <sup>2</sup> )	<i>430759H</i> <i>Price gr. A166 (m<sup>2</sup>)</i>	<b>430765H</b> Price gr. <b>A136</b> (m <sup>2</sup> )	<i>430769H</i> <i>Price gr. A148 (m<sup>2</sup>)</i>	<b>430773H</b> Price gr. <b>A175</b> (m <sup>2</sup> )	<i>430777H</i> <i>Price gr. A142 (m<sup>2</sup>)</i>
graphite	<b>430762H</b> Price gr. <b>A127</b> (m <sup>2</sup> )	<b>430756H</b> Price gr. <b>A166</b> (m <sup>2</sup> )	<i>430760H</i> <i>Price gr. A166 (m<sup>2</sup>)</i>	<b>430766H</b> Price gr. <b>A136</b> (m <sup>2</sup> )	<i>430770H</i> <i>Price gr. A148 (m<sup>2</sup>)</i>	<b>430774H</b> Price gr. <b>A175</b> (m <sup>2</sup> )	<i>430778H</i> <i>Price gr. A142 (m<sup>2</sup>)</i>
shell	<b>431533H</b> Price gr. <b>A127</b> (m <sup>2</sup> )	<b>431534H</b> Price gr. <b>A166</b> (m <sup>2</sup> )	<i>431536H</i> <i>Price gr. A166 (m<sup>2</sup>)</i>	<b>431538H</b> Price gr. <b>A136</b> (m <sup>2</sup> )	<i>431540H</i> <i>Price gr. A148 (m<sup>2</sup>)</i>	<b>431542H</b> Price gr. <b>A175</b> (m <sup>2</sup> )	<i>431544H</i> <i>Price gr. A142 (m<sup>2</sup>)</i>
sand		<b>431535H</b> Price gr. <b>A166</b> (m <sup>2</sup> )	<i>431537H</i> <i>Price gr. A166 (m<sup>2</sup>)</i>	<b>431539H</b> Price gr. <b>A136</b> (m <sup>2</sup> )	<i>431541H</i> <i>Price gr. A148 (m<sup>2</sup>)</i>	<b>431543H</b> Price gr. <b>A175</b> (m <sup>2</sup> )	<i>431545H</i> <i>Price gr. A142 (m<sup>2</sup>)</i>



<sup>2</sup> Supplied as double-tiles; to be broken by customer.



Wall Tile<sup>2</sup>

Floor Tiles<sup>2</sup>

Grooved Tiles 12.5 mm thick,  
for continuing the pool edge system  
„Finland II“<sup>1/3/4</sup>

25 x 50 cm



25 x 50 cm



25 x 50 cm<sup>1</sup>



50 x 25 cm

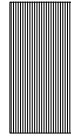

25 x 25 cm



12,5 x 25 cm



Grid profile tile							
<b>25 x 50</b> / 10 x 20	<b>25 x 50</b> / 10 x 20	<b>25 x 50</b> / 10 x 20		<b>50 x 25</b> / 20 x 10	<b>25 x 25</b> / 10 x 10	<b>12.5 x 25</b> / 5 x 10	Nom. dim. - <b>cm/in</b>
244 x 494 x 8 mm	244 x 494 x 8 mm	244 x 494 x 8 mm		494 x 244 x 12.5 mm	244 x 244 x 12.5 mm	119 x 244 x 12.5 mm	Work size - <b>mm</b>
structured, matt	structured, matt	relief, matt		grooved, matt	grooved, matt	grooved, matt	Surface
8.000/m <sup>2</sup>	8.000/m <sup>2</sup>	8.000/m <sup>2</sup>		2.000/m	4.000/m	8.000/m	<b>m<sup>2</sup>/m</b> - pieces
17.040/m <sup>2</sup>	17.040/m <sup>2</sup>	17.040/m <sup>2</sup>		3.550/piece	1.775/piece	0.888/piece	<b>m<sup>2</sup>/pce.</b> - kg
9	9	9		6	9	21	<b>Bundle</b> - pieces
1.125/m <sup>2</sup>	1.125/m <sup>2</sup>	1.125/m <sup>2</sup>		3.000/m	2.250/m	2.625/m	<b>Bundle</b> - m <sup>2</sup> / m
19.170	19.170	19.170		21.300	15.975	18.648	<b>Bundle</b> - kg
40.500	40.500	40.500					<b>Pallet</b> - m <sup>2</sup>
690.120	690.120	690.120					<b>Pallet</b> - kg
Ala	Ala	Ala		Ala	Ala	Ala	Product standard
-	R11/B	R11/C		R11/C	R11/C	R11/C	Slip resistance
	2	2					Stress group
<b>430779H</b>	<b>430781H</b>	<b>430785H</b>		<b>430789H</b>	<b>430793H</b>	<b>430802H</b>	pearl <input type="checkbox"/> V3
Price gr. <b>A154</b> (m <sup>2</sup> )	Price gr. <b>A166</b> (m <sup>2</sup> )	Price gr. <b>A187</b> (m <sup>2</sup> )		Price gr. <b>A560</b> (pce.)	Price gr. <b>A480</b> (pce.)	Price gr. <b>A430</b> (pce.)	
	<b>430782H</b>	<b>430786H</b>		<b>430790H</b>	<b>430794H</b>	<b>430803H</b>	mud <input type="checkbox"/> V3
	Price gr. <b>A166</b> (m <sup>2</sup> )	Price gr. <b>A187</b> (m <sup>2</sup> )		Price gr. <b>A560</b> (pce.)	Price gr. <b>A480</b> (pce.)	Price gr. <b>A430</b> (pce.)	
	<b>430783H</b>	<b>430787H</b>		<b>430791H</b>	<b>430795H</b>	<b>430804H</b>	stone <input type="checkbox"/> V3
	Price gr. <b>A166</b> (m <sup>2</sup> )	Price gr. <b>A187</b> (m <sup>2</sup> )		Price gr. <b>A560</b> (pce.)	Price gr. <b>A480</b> (pce.)	Price gr. <b>A430</b> (pce.)	
<b>430780H</b>	<b>430784H</b>	<b>430788H</b>		<b>430792H</b>	<b>430796H</b>	<b>430805H</b>	graphite <input type="checkbox"/> V3
Price gr. <b>A154</b> (m <sup>2</sup> )	Price gr. <b>A166</b> (m <sup>2</sup> )	Price gr. <b>A187</b> (m <sup>2</sup> )		Price gr. <b>A560</b> (pce.)	Price gr. <b>A480</b> (pce.)	Price gr. <b>A430</b> (pce.)	
<b>431546H</b>	<b>431547H</b>	<b>431549H</b>		<b>431551H</b>	<b>431553H</b>	<b>431555H</b>	shell <input type="checkbox"/> V3
Price gr. <b>A154</b> (m <sup>2</sup> )	Price gr. <b>A166</b> (m <sup>2</sup> )	Price gr. <b>A187</b> (m <sup>2</sup> )		Price gr. <b>A560</b> (pce.)	Price gr. <b>A480</b> (pce.)	Price gr. <b>A430</b> (pce.)	
	<b>431548H</b>	<b>431550H</b>		<b>431552H</b>	<b>431554H</b>	<b>431556H</b>	sand <input type="checkbox"/> V3
	Price gr. <b>A166</b> (m <sup>2</sup> )	Price gr. <b>A187</b> (m <sup>2</sup> )		Price gr. <b>A560</b> (pce.)	Price gr. <b>A480</b> (pce.)	Price gr. <b>A430</b> (pce.)	



<sup>3</sup> Short edge rectified

<sup>4</sup> For more details concerning the pool edge system Finland II, refer to the Pool + Spa programme of delivery.



**Cove Skirting, decorated**<sup>1/2/10</sup>

10 x 25 cm



**Gutter Tiles**<sup>2/3/4/6</sup>

50 x 25 cm

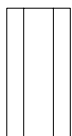

50 x 25 cm<sup>5</sup>

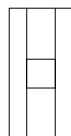

50 x 25 cm

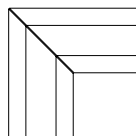

50 x 25 cm<sup>5</sup>

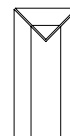

	<b>10 x 25 / 4 x 10</b>	<b>Gutter Tile</b>	<b>50 x 25 / 20 x 10</b>	<b>50 x 25 / 20 x 10</b>	<b>Gutter tile with outlet 110 / 110 mm</b>	<b>Gutter tile, mitred pair</b>	<b>Gutter tile, terminal piece</b>
Nom. dim. - cm/in	100 x 244/35 x 9 mm	494 x 244 x 14 mm	494 x 244 x 14 mm	494 x 244 x 14 mm	(2x) 490 x 244 x 14 mm	494 x 244 x 14 mm	
Work size - mm	structured, matt	structured, matt	structured, matt	structured, matt	structured, matt	structured, matt	
Surface	m	m	m	m	m	m	
m - pieces	4.000	2.000	2.000	2.000	2.000	2.000	
pce./pair - kg	0.500/piece	2.500/piece	2.500/piece	2.300/piece	3.800/pair	2.500/piece	
Bundle - pce./pair	20 piece	5 piece	5 piece	5 piece	2 pair	5 piece	
Bundle - m		2.500	2.500				
Bundle - kg	10.000	12.500	11.500	7.600	12.500		
Pallet - m <sup>2</sup>							
Pallet - kg							
Product standard	Alb	Ala	Ala	Ala	Ala	Ala	
Slip resistance	R10/A	R11/B	R11/B	R11/B	R11/B	R11/B	
pearl	<input checked="" type="checkbox"/> V3						
mud	<input checked="" type="checkbox"/> V3						
stone	<input checked="" type="checkbox"/> V3						
graphite	<input checked="" type="checkbox"/> V3						
shell	<input checked="" type="checkbox"/> V3						
sand	<input checked="" type="checkbox"/> V3						



<sup>3</sup> Also available in a length of 497 mm on request

<sup>4</sup> Short edges rectified

<sup>5</sup> Minimum order quantity: 10 pieces. In case of smaller quantities, the price must be individually calculated.

<sup>6</sup> For further details concerning gutter tiles, refer to the Pool + Spa programme of delivery.

<sup>7</sup> Stress group: 2

<sup>8</sup> Stress group: 3

<sup>9</sup> Stress group: 4

<sup>10</sup> Color deviations compared to the adjoining covering due to production are no reason for complaint in case of horizontal laying.

Patio Tiles –  
joint 3 mm<sup>1</sup>

50 x 100 cm

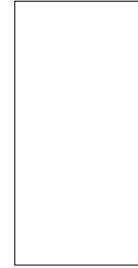

						<b>50 x 100 / 20 x 40</b>		Nom. dim. - <b>cm/in</b>
						497 x 997 x 20 mm		Work size - <b>mm</b>
						structured, matt		Surface
						2.000		m <sup>2</sup> - pieces
						43.060		m <sup>2</sup> - kg
						1		<b>Bundle</b> - pieces
						0.500		<b>Bundle</b> - m <sup>2</sup>
						21.530		<b>Bundle</b> - kg
						22.500		<b>Pallet</b> - m <sup>2</sup>
						968.850		<b>Pallet</b> - kg
						Alla		Product standard
						R11/B		Slip resistance
						3		Stress group
						<b>430826H</b>	<b>4</b>	
						Price gr. <b>A277</b> (m <sup>2</sup> )		pearl <span style="border: 1px solid black; padding: 0 2px;">V3</span>
						<b>430827H</b>	<b>4</b>	
						Price gr. <b>A277</b> (m <sup>2</sup> )		mud <span style="border: 1px solid black; padding: 0 2px;">V3</span>
						<b>430828H</b>	<b>4</b>	
						Price gr. <b>A277</b> (m <sup>2</sup> )		stone <span style="border: 1px solid black; padding: 0 2px;">V3</span>
						<b>430829H</b>	<b>4</b>	
						Price gr. <b>A277</b> (m <sup>2</sup> )		graphite <span style="border: 1px solid black; padding: 0 2px;">V3</span>
						<b>431567H</b>	<b>4</b>	
						Price gr. <b>A277</b> (m <sup>2</sup> )		sand <span style="border: 1px solid black; padding: 0 2px;">V3</span>







## Modern and durable

Basic Stone was inspired by slate structures. The 5 x 5 cm mosaic's ceramic surface, made of unglazed porcelain stoneware with a Hytect finish, represents the theme of slate in a modern and durable way through a relief mix combined with discreet graphics. Glossy mica accents and subtle color contrasts highlight the stony character of the surface. The color palette draws from natural slate tones.

Rendering

### Mosaic, 5 x 5 cm, 2 x 2 in



Mosaic sheet 30 x 30 cm, 12 x 12 in, black, structured, R10/B



Mosaic sheet 30 x 30 cm, 12 x 12 in, medium grey, structured, R10/B



Mosaic sheet 30 x 30 cm, 12 x 12 in, light grey, structured, R10/B



Mosaic sheet 30 x 30 cm, 12 x 12 in, mud, structured, R10/B



Mosaic sheet 30 x 30 cm, 12 x 12 in, beige, structured, R10/B



Mosaics glued thermoplastically on back of Agrob Buchtal can be used not only in dry zones but also without any problems in underwater areas (e.g. swimming pools/whirlpools) as well as in permanently wet areas (e.g. pool surrounds/showers).

Mosaic

5 x 5 cm

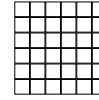

Sheet: 297 x 297 mm



					<b>5 x 5 / 2 x 2</b>	Nom. dim. - <b>cm/in</b>
					47 x 47 x 6.5 mm	Work size
					structured, matt	Surface
					11 sheets	<b>m<sup>2</sup></b> - pieces
					12.331	<b>m<sup>2</sup></b> - kg
					11 sheets	<b>Bundle</b> - pieces
					1.000	<b>Bundle</b> - m <sup>2</sup>
					12.331	<b>Bundle</b> - kg
					64.000	<b>Pallet</b> - m <sup>2</sup>
					789.184	<b>Pallet</b> - kg
					Bla	Product standard
					R10/B	Slip resistance
					1	Stress group
					<b>42200H-73</b>	
					Price gr. <b>A211</b> (m <sup>2</sup> )	black <input type="checkbox"/> V2
					<b>42201H-73</b>	
					Price gr. <b>A211</b> (m <sup>2</sup> )	medium grey <input type="checkbox"/> V2
					<b>42202H-73</b>	
					Price gr. <b>A211</b> (m <sup>2</sup> )	light-grey <input type="checkbox"/> V2
					<b>42203H-73</b>	
					Price gr. <b>A211</b> (m <sup>2</sup> )	mud <input type="checkbox"/> V2
					<b>42204H-73</b>	
					Price gr. <b>A211</b> (m <sup>2</sup> )	beige <input type="checkbox"/> V2









## Timeless and simple

The timeless color palette and formats, ranging from 5 x 5 cm to 35 x 100 cm, offer economical solutions for various areas. The Basis Pro series enhances the existing collection by adding a selection of porcelain stoneware floor tiles with a contemporary and durable design. Additional features include high slip resistances ranging from R10/A to R13V10, as well as shower tub systems, stair tiles, and special pieces to complete the range.

Olympia-Stadion, Berlin, Germany / Architect: von Gerkan, Marg und Partner, Berlin / Photo: FSMK Architektur + Industriefotograf



**Basis 1**  
Earthenware, glazed

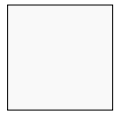

white, glossy

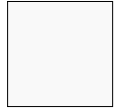

white, matt



white matt and glossy undulated

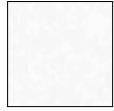

white, glossy, hammered



white, marbled, glossy and matt



pale grey, marbled, glossy and matt



beige, marbled, glossy and matt



sand-beige glossy and matt

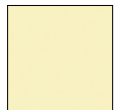

ivory, glossy

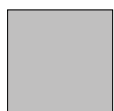

light grey, matt

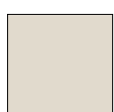

light-beige, matt



Listel Candy, 4.5 x 20 cm, 1 13/16 x 8 in



Listel Candy, 1 x 20 cm, 3/8 x 8 in

**Basis 1+**  
Earthenware, glazed



white, glossy

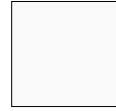

white, matt



white, glossy undulated



white, matt undulated

**Basis 2**  
Earthenware, glazed

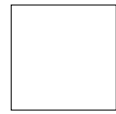

white, matt



white, glossy



grey, matt

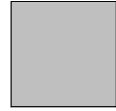

light grey, matt



light-beige, matt

**Basis 3**  
Porcelain stoneware, unglazed



titanit



anthracite



medium grey



chalk



smooth R10/A and R10/B



Softcorn 2 R11/B



Perlstic R12



Opticorn R12V4



Picstic R12V8

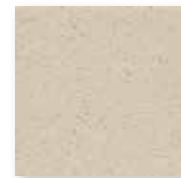

Roughened R13



Kombicorn R13V10

**Basis 4**  
Stoneware tiles, glazed



white, glossy



white, matt



grey transparent matt

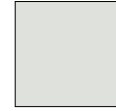

light-grey, matt



light-sahara, matt



soft azure, glossy



light-blue, glossy



azure dark, glossy

## Wall Tiles

15 x 15 cm



15 x 15 cm



15 x 30 cm



20 x 20 cm



20 x 25 cm



20 x 40 cm



25 x 33 cm



15 x 15 / 6 x 6	15 x 15 / 6 x 6	15 x 30 cm / 6 x 12	20 x 20 / 8 x 8	20 x 25 / 8 x 10	20 x 40 / 8 x 16	25 x 33 / 10 x 13	Nom. dim. - cm/in
150 x 150 x 5.5 mm	147 x 147 x 5.5 mm	147 x 297 x 6.5 mm	197 x 197 x 6.0 mm	198 x 248 x 6.0 mm	197 x 397 x 7.5 mm	249 x 330 x 8.0 mm	Work size
smooth	smooth	smooth	smooth	smooth	smooth	smooth	Surface
44.000	44.000	22.222	25.000	20.000	12.500	12.121	m <sup>2</sup> - pieces
9.504	9.416	10.622	10.800	10.260	12.975	12.969	m <sup>2</sup> - kg
44	44	24	25	20	16	13	Bundle - pieces
1.000	1.000	1.080	1.000	1.000	1.280	1.073	Bundle - m <sup>2</sup>
9.504	9.416	11.472	10.800	10.260	16.608	13.910	Bundle - kg
105.000	105.000	91.801	96.000	92.000	92.160	80.439	Pallet - m <sup>2</sup>
997.920	988.680	975.120	1,036.800	943.920	1.195.776	1,043.250	Pallet - kg
BIII	BIII	BIII	BIII	BIII	BIII	BIII	Product standard
<b>112000</b>	<b>531910-148</b>	<b>173368</b>	<b>532230-800</b>	<b>538020-400</b>	<b>182763</b>	<b>239996</b>	white, glossy <input type="checkbox"/>
Price gr. <b>A34</b> (m <sup>2</sup> )	Price gr. <b>A25</b> (m <sup>2</sup> )	Price gr. <b>A43</b> (m <sup>2</sup> )	Price gr. <b>A25</b> (m <sup>2</sup> )	Price gr. <b>A25</b> (m <sup>2</sup> )	Price gr. <b>A43</b> (m <sup>2</sup> )	Price gr. <b>A31</b> (m <sup>2</sup> )	
<b>115100</b>	<b>531911-148</b>	<b>173369</b>	<b>532212-800</b>	<b>538021-400</b>	<b>182764</b>	<b>239995</b>	white, matt <input type="checkbox"/>
Price gr. <b>A34</b> (m <sup>2</sup> )	Price gr. <b>A25</b> (m <sup>2</sup> )	Price gr. <b>A43</b> (m <sup>2</sup> )	Price gr. <b>A25</b> (m <sup>2</sup> )	Price gr. <b>A25</b> (m <sup>2</sup> )	Price gr. <b>A43</b> (m <sup>2</sup> )	Price gr. <b>A31</b> (m <sup>2</sup> )	
						<b>239998</b>	white, glossy, undulated <input type="checkbox"/>
						Price gr. <b>A34</b> (m <sup>2</sup> )	
						<b>239997</b>	white, matt, undulated <input type="checkbox"/>
						Price gr. <b>A34</b> (m <sup>2</sup> )	
<b>113063</b>							white, glossy, hammered <input type="checkbox"/>
Price gr. <b>A112</b> (m <sup>2</sup> )							
<b>111052</b>							ivory, glossy <input type="checkbox"/>
Price gr. <b>A112</b> (m <sup>2</sup> )							
				<b>538260-400</b>		<b>231032</b>	light-grey, marbled, glossy <input type="checkbox"/>
				Price gr. <b>A31</b> (m <sup>2</sup> )		Price gr. <b>A34</b> (m <sup>2</sup> )	
				<b>538261-400</b>		<b>231034</b>	light-grey, marbled, matt <input type="checkbox"/>
				Price gr. <b>A31</b> (m <sup>2</sup> )		Price gr. <b>A34</b> (m <sup>2</sup> )	
				<b>538280-400</b>			beige marbled, glossy <input type="checkbox"/>
				Price gr. <b>A31</b> (m <sup>2</sup> )			
				<b>538281-400</b>			beige marbled, matt <input type="checkbox"/>
				Price gr. <b>A31</b> (m <sup>2</sup> )			
		<b>173339</b>	<b>213341</b>		<b>183343</b>		light-grey, matt <input type="checkbox"/>
		Price gr. <b>A52</b> (m <sup>2</sup> )	Price gr. <b>A34</b> (m <sup>2</sup> )		Price gr. <b>A55</b> (m <sup>2</sup> )		
		<b>173340</b>	<b>213342</b>		<b>183344</b>		light-beige, matt <input type="checkbox"/>
		Price gr. <b>A52</b> (m <sup>2</sup> )	Price gr. <b>A34</b> (m <sup>2</sup> )		Price gr. <b>A55</b> (m <sup>2</sup> )		

Wall Tiles

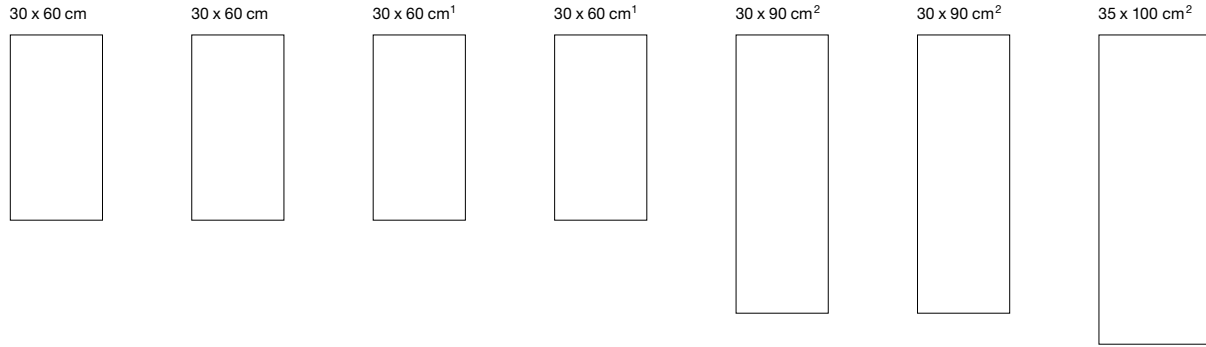

Nom. dim. - cm/in	<b>30 x 60</b> / 12 x 24	<b>30 x 60</b> / 12 x 24	<b>30 x 60</b> / 12 x 24	<b>30 x 60</b> / 12 x 24	<b>30 x 90</b> / 12 x 36	<b>30 x 90</b> / 12 x 36	<b>35 x 100</b> / 14 x 40
Work size	297 x 597 x 9.0 mm	297 x 597 x 6.0 mm	297 x 597 x 6.0 mm	297 x 597 x 9.0 mm	297 x 897 x 6.0 mm	297 x 897 x 10.5 mm	347 x 997 x 6 mm
Surface	smooth	smooth	smooth	smooth	smooth	smooth	smooth
m <sup>2</sup> - pieces	5.556	5.556	5.556	5.556	3.704	3.704	2.857
m <sup>2</sup> - kg	14.946	10.279	10.279	15.279	10.400	17.976	10.108
Bundle - pieces	9	13	13	9	8	5	5
Bundle - m <sup>2</sup>	1.620	2.340	2.340	1.620	2.160	1.350	1.750
Bundle - kg	24.210	24.050	24.050	24.750	22.464	24.265	17.690
Pallet - m <sup>2</sup>	77.754	112.311	112.311	77.754	51.836	32.397	70.004
Pallet - kg	1,162.080	1,154.400	1,154.400	1,188.000	539.136	582.360	707.600
Product standard	BIII	BIII	BIII	BIII	BIII	BIII	BIII
white, glossy <input type="checkbox"/>	<b>280374</b> Price gr. <b>A34</b> (m <sup>2</sup> )	<b>203264</b> Price gr. <b>A34</b> (m <sup>2</sup> )	<b>203459R</b> Price gr. <b>A52</b> (m <sup>2</sup> )	<b>282115R-02</b> Price gr. <b>A79</b> (m <sup>2</sup> )	<b>323260</b> Price gr. <b>A103</b> (m <sup>2</sup> )	<b>391589</b> Price gr. <b>A124</b> (m <sup>2</sup> )	<b>363335</b> Price gr. <b>A103</b> (m <sup>2</sup> )
white, matt <input type="checkbox"/>	<b>280375</b> Price gr. <b>A34</b> (m <sup>2</sup> )	<b>203265</b> Price gr. <b>A34</b> (m <sup>2</sup> )	<b>203460R</b> Price gr. <b>A52</b> (m <sup>2</sup> )	<b>282116R-02</b> Price gr. <b>A79</b> (m <sup>2</sup> )	<b>323261</b> Price gr. <b>A103</b> (m <sup>2</sup> )	<b>391590</b> Price gr. <b>A124</b> (m <sup>2</sup> )	<b>363336</b> Price gr. <b>A103</b> (m <sup>2</sup> )
white, glossy, undulated <input type="checkbox"/>	<b>280718</b> Price gr. <b>A46</b> (m <sup>2</sup> )						
white, matt, undulated <input type="checkbox"/>	<b>280719</b> Price gr. <b>A46</b> (m <sup>2</sup> )						
white marbled, glossy <input type="checkbox"/>		<b>203444</b> Price gr. <b>A46</b> (m <sup>2</sup> )					
white marbled, matt <input type="checkbox"/>		<b>203445</b> Price gr. <b>A46</b> (m <sup>2</sup> )					
sand-beige, glossy <input type="checkbox"/>	<b>280871</b> Price gr. <b>A46</b> (m <sup>2</sup> )						
sand-beige, matt <input type="checkbox"/>	<b>280872</b> Price gr. <b>A46</b> (m <sup>2</sup> )						
light-grey, matt <input type="checkbox"/>	<b>283345</b> Price gr. <b>A46</b> (m <sup>2</sup> )						
light-beige, matt <input type="checkbox"/>	<b>283346</b> Price gr. <b>A46</b> (m <sup>2</sup> )						

Listel



Nom. dim. - cm/in	<b>1 x 20</b> / 3/8 x 8	<b>4,5 x 20</b> / 1 13/16 x 8				
Work size	10 x 197 x 6.0 mm	45 x 197 x 6.0 mm				
Surface	smooth, silky-matt	smooth, silky-matt				
m <sup>2</sup> - pieces	5.000/m	5.000/m				
m <sup>2</sup> - kg	0.125/m	0.505/m				
Bundle - pieces	100	72				
Bundle - m <sup>2</sup>	20.000 m	14.400 m				
Bundle - kg	2.500	7.272				
Pallet - m <sup>2</sup>						
Pallet - kg						
Product standard	BIII	BIII				
candy <input type="checkbox"/>	<b>533436-198</b> Price gr. <b>A423</b> (pce.)	<b>533434-198</b> Price gr. <b>A445</b> (pce.)				



### Wall Tiles

30 x 60 cm



30 x 60 cm<sup>1</sup>



30 x 60 cm

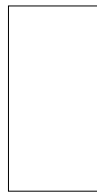

30 x 60 cm<sup>1</sup>



30 x 90 cm<sup>2</sup>

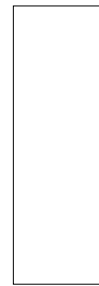

30 x 90 cm<sup>2</sup>



	30 x 60 / 12 x 24	30 x 60 / 12 x 24	30 x 60 / 12 x 24	30 x 60 / 12 x 24	30 x 90 / 12 x 36	30 x 90 / 12 x 36	Nom. dim. - cm/in
	297 x 597 x 9.0 mm	297 x 597 x 9.0 mm	297 x 597 x 6.0 mm	297 x 597 x 6.0 mm	297 x 897 x 10.5 mm	297 x 897 x 6 mm	Work size
	smooth	smooth	smooth	smooth	smooth	smooth	Surface
	5.556	5.556	5.556	5.556	3.704	3.704	m <sup>2</sup> - pieces
	14.946	15.279	10.279	10.279	17.976	10.400	m <sup>2</sup> - kg
	9	9	13	13	5	8	Bundle - pieces
	1.620	1.620	2.340	2.340	1.350	2.160	Bundle - m <sup>2</sup>
	24.210	24.750	24.050	24.050	24.265	22.464	Bundle - kg
	77.754	77.754	112.311	112.311	32.397	51.836	Pallet - m <sup>2</sup>
	1,162.080	1,188.000	1,154.400	1,154.400	582.360	539.136	Pallet - kg
	BIII	BIII	BIII	BIII	BIII	BIII	Product standard
	<b>289358</b>	<b>282887R</b>	<b>203266H</b>	<b>203461HR</b>	<b>391572</b>	<b>323262H</b>	white, glossy <input type="checkbox"/>
	Price gr. <b>A55</b> (m <sup>2</sup> )	Price gr. <b>A94</b> (m <sup>2</sup> )	Price gr. <b>A46</b> (m <sup>2</sup> )	Price gr. <b>A64</b> (m <sup>2</sup> )	Price gr. <b>A139</b> (m <sup>2</sup> )	Price gr. <b>A115</b> (m <sup>2</sup> )	white, matt <input type="checkbox"/>
	<b>289359</b>	<b>282888R</b>	<b>203267H</b>	<b>203462HR</b>	<b>391573</b>	<b>323263H</b>	white, glossy, undulated <input type="checkbox"/>
	Price gr. <b>A55</b> (m <sup>2</sup> )	Price gr. <b>A94</b> (m <sup>2</sup> )	Price gr. <b>A46</b> (m <sup>2</sup> )	Price gr. <b>A64</b> (m <sup>2</sup> )	Price gr. <b>A139</b> (m <sup>2</sup> )	Price gr. <b>A115</b> (m <sup>2</sup> )	white, matt, undulated <input type="checkbox"/>
	<b>289360</b>						
	Price gr. <b>A61</b> (m <sup>2</sup> )						
	<b>289361</b>						
	Price gr. <b>A61</b> (m <sup>2</sup> )						

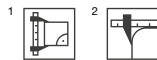

Wall/Floor Tiles

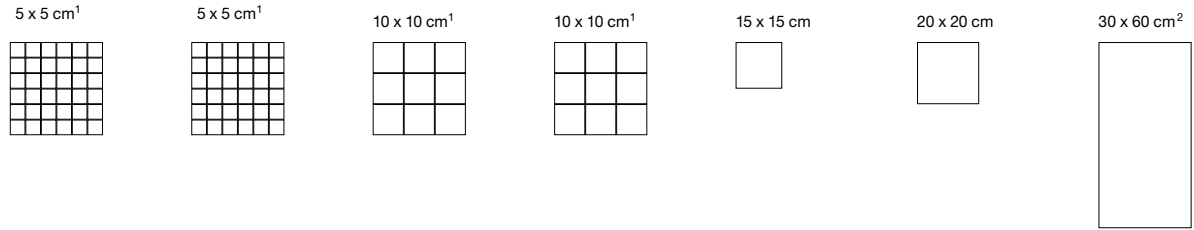

	Sheet: 297 x 297 mm	Sheet: 297 x 297 mm	Sheet: 297 x 297 mm	Sheet: 297 x 297 mm			
Nom. dim. - cm/in	5 x 5 / 2 x 2	5 x 5 / 2 x 2	10 x 10 / 4 x 4	10 x 10 / 4 x 4	15 x 15 / 6 x 6	20 x 20 / 8 x 8	30 x 60 / 12 x 24
Work size	47 x 47 x 6.5 mm	47 x 47 x 6.5 mm	97 x 97 x 6.5 mm	97 x 97 x 6.5 mm	147 x 147 x 6.5 mm	197 x 197 x 6.5 mm	297 x 597 x 8.0 mm
Surface	smooth, matt	smooth, matt	smooth, matt	smooth, matt	smooth, matt	smooth, matt	smooth
m <sup>2</sup> /m - pieces	11 sheets	11 sheets	11 sheets/m <sup>2</sup>	11 sheets/m <sup>2</sup>	44.000/m <sup>2</sup>	25.000/m <sup>2</sup>	5.556/m <sup>2</sup>
m <sup>2</sup> /m - kg	12.331	12.331	13.101/m <sup>2</sup>	13.101/m <sup>2</sup>	13.816/m <sup>2</sup>	13.875/m <sup>2</sup>	17.413/m <sup>2</sup>
Bundle - pieces	11 sheets	11 sheets	11 sheets	11 sheets	44	25	6
Bundle - m <sup>2</sup> /m	1.000	1.000	1.000 m <sup>2</sup>	1.000 m <sup>2</sup>	1.000 m <sup>2</sup>	1.000 m <sup>2</sup>	1.080 m <sup>2</sup>
Bundle - kg	12.331	12.331	13.101	13.101	13.816	13.875	18.804
Pallet - m <sup>2</sup>	64.000	64.000	64.000	64.000	80.000	72.000	43.197
Pallet - kg	789.184	789.184	838.464	838.464	1,105.280	999.000	752.160
Product standard	Blb	Blb	Blb	Blb	Blb	Blb	Alb
Slip resistance		R10/B		R10/B			
Stress group	1	1	1	1	1	1	1
	4 <b>431006</b>	4 <b>431008</b>	4 <b>620811-504</b>	4 <b>600859-504</b>	4 <b>620805-504</b>	4 <b>620806-504</b>	4 <b>430964</b>
white, matt	Price gr. <b>A148</b> (m <sup>2</sup> )	Price gr. <b>A157</b> (m <sup>2</sup> )	Price gr. <b>A91</b> (m <sup>2</sup> )	Price gr. <b>A115</b> (m <sup>2</sup> )	Price gr. <b>A73</b> (m <sup>2</sup> )	Price gr. <b>A61</b> (m <sup>2</sup> )	Price gr. <b>A112</b> (m <sup>2</sup> )
	4						4 <b>430963</b>
white, glossy							Price gr. <b>A112</b> (m <sup>2</sup> )
	4 <b>431007</b>	4 <b>431009</b>	4 <b>620811-505</b>	4 <b>600859-505</b>	4 <b>620805-505</b>	4 <b>620806-505</b>	
grey	Price gr. <b>A148</b> (m <sup>2</sup> )	Price gr. <b>A157</b> (m <sup>2</sup> )	Price gr. <b>A91</b> (m <sup>2</sup> )	Price gr. <b>A115</b> (m <sup>2</sup> )	Price gr. <b>A73</b> (m <sup>2</sup> )	Price gr. <b>A61</b> (m <sup>2</sup> )	
	4					4 <b>430967</b>	4 <b>430965</b>
light-grey, matt						Price gr. <b>A94</b> (m <sup>2</sup> )	Price gr. <b>A127</b> (m <sup>2</sup> )
	4					4 <b>430968</b>	4 <b>430966</b>
light-beige matt						Price gr. <b>A94</b> (m <sup>2</sup> )	Price gr. <b>A127</b> (m <sup>2</sup> )



Cove Skirting

10 x 10 cm<sup>3</sup>



Nom. dim. - cm/in	10 x 10 / 4 x 4						
Work size	100 x 97 x 6.0 mm						
Surface	smooth, matt						
m <sup>2</sup> /m - pieces	10.000						
m <sup>2</sup> /m - kg	1.500						
Bundle - pieces	40						
Bundle - m <sup>2</sup> /m	4.000						
Bundle - kg	6.000						
Pallet - m <sup>2</sup>							
Pallet - kg							
Product standard	Blb						
Slip resistance	R10/B						
	4 <b>600864-504</b>						
white, matt	Price gr. <b>A413</b> (pce.)						
	4 <b>600864-505</b>						
grey	Price gr. <b>A413</b> (pce.)						

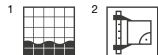

<sup>3</sup> For details, refer to page 536 and the following

Wall/Floor Tiles

5 x 5 cm<sup>1</sup>

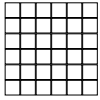

10 x 10 cm<sup>1</sup>

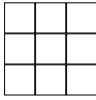

15 x 15 cm



15 x 15 cm



20 x 20 cm



20 x 20 cm



20 x 20 cm



protected

Sheet: 297 x 297 mm	Sheet: 297 x 297 mm	Micro	Softcorn 2	Micro	Softcorn 2	Perlstic	
<b>5 x 5 / 2 x 2</b>	<b>10 x 10 / 4 x 4</b>	<b>15 x 15 / 6 x 6</b>	<b>15 x 15 / 6 x 6</b>	<b>20 x 20 / 8 x 8</b>	<b>20 x 20 / 8 x 8</b>	<b>20 x 20 / 8 x 8</b>	Nom. dim. - cm/in
47 x 47 x 6.5 mm	97 x 97 x 6.5 mm	147 x 147 x 10.5 mm	147 x 147 x 10.5 mm	197 x 197 x 9.0 mm	197 x 197 x 9.0 mm	197 x 197 x 9.0 mm	Work size
smooth, matt	smooth, matt	smooth, matt	structured, matt	smooth, matt	structured, matt	fine-grained, matt	Surface
11 sheets	11 sheets	44.444	44.444	25.000	25.000	25.000	m <sup>2</sup> - pieces
12.331	13.101	23.111	23.111	19.450	19.450	19.450	m <sup>2</sup> - kg
11 sheets	11 sheets	27	27	25	25	25	Bundle - pieces
1.000	1.000	0.608	0.608	1.000	1.000	1.000	Bundle - m <sup>2</sup>
12.331	13.101	14.040	14.040	19.450	19.450	19.450	Bundle - kg
64.000	64.000	48.600	48.600	60.000	60.000	60.000	Pallet - m <sup>2</sup>
789.184	838.464	1,123.200	1,123.200	1,167.000	1,167.000	1,167.000	Pallet - kg
Bla	Bla	Bla	Bla	Bla	Bla	Bla	Product standard
R10/B	R10/B	R10/A	R11/B	R10/A	R11/B	R12	Slip resistance
1	1	3	3	2	2	2	Stress group
<b>620510-070</b>	<b>620460-070</b>	<b>601500-070-71</b>	<b>601550-070-71</b>	<b>620249-070</b>	<b>620450-070</b>	<b>620470-070</b>	titanit <input type="checkbox"/> V1
Price gr. A160 (m <sup>2</sup> )	Price gr. A124 (m <sup>2</sup> )	Price gr. A79 (m <sup>2</sup> )	Price gr. A94 (m <sup>2</sup> )	Price gr. A70 (m <sup>2</sup> )	Price gr. A85 (m <sup>2</sup> )	Price gr. A85 (m <sup>2</sup> )	
<b>620510-072</b>	<b>620460-072</b>	<b>601500-072-71</b>	<b>601550-072-71</b>	<b>620249-072</b>	<b>620450-072</b>	<b>620470-072</b>	anthracite <input type="checkbox"/> V1
Price gr. A160 (m <sup>2</sup> )	Price gr. A124 (m <sup>2</sup> )	Price gr. A79 (m <sup>2</sup> )	Price gr. A94 (m <sup>2</sup> )	Price gr. A70 (m <sup>2</sup> )	Price gr. A85 (m <sup>2</sup> )	Price gr. A85 (m <sup>2</sup> )	
<b>620510-073</b>	<b>620460-073</b>			<b>620249-073</b>	<b>620450-073</b>	<b>620470-073</b>	medium grey <input type="checkbox"/> V1
Price gr. A160 (m <sup>2</sup> )	Price gr. A124 (m <sup>2</sup> )			Price gr. A70 (m <sup>2</sup> )	Price gr. A85 (m <sup>2</sup> )	Price gr. A85 (m <sup>2</sup> )	
<b>620510-075</b>	<b>620460-075</b>	<b>601500-075-71</b>	<b>601550-075-71</b>	<b>620249-075</b>	<b>620450-075</b>	<b>620470-075</b>	chalk <input type="checkbox"/> V1
Price gr. A160 (m <sup>2</sup> )	Price gr. A124 (m <sup>2</sup> )	Price gr. A79 (m <sup>2</sup> )	Price gr. A94 (m <sup>2</sup> )	Price gr. A70 (m <sup>2</sup> )	Price gr. A85 (m <sup>2</sup> )	Price gr. A85 (m <sup>2</sup> )	



Wall/Floor Tiles

20 x 20 cm



20 x 20 cm<sup>2</sup>



20 x 20 cm



20 x 20 cm



30 x 30 cm



30 x 30 cm

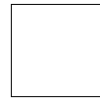

protected

Opticorn	Picstic	Geraut	Kombicorn	Micro	Softcorn 2	
<b>20 x 20 / 8 x 8</b>	<b>20 x 20 / 8 x 8</b>	<b>20 x 20 / 8 x 8</b>	<b>20 x 20 / 8 x 8</b>	<b>30 x 30 / 12 x 12</b>	<b>30 x 30 / 12 x 12</b>	Nom. dim. - cm/in
197 x 197 x 9.0 mm	197 x 197 x 9.0 mm	197 x 197 x 9.0 mm	197 x 197 x 9.0 mm	297 x 297 x 9.0 mm	297 x 297 x 9.0 mm	Work size
grained, matt	grained, matt	profiled, matt	profiled, matt	structured, matt	structured, matt	Surface
25.000	25.000	25.000	25.000	11.111	11.111	m <sup>2</sup> - pieces
19.450	19.450	19.450	19.450	19.478	19.478	m <sup>2</sup> - kg
25	25	25	25	13	13	Bundle - pieces
1.000	1.000	1.000	1.000	1.170	1.170	Bundle - m <sup>2</sup>
19.450	19.450	19.450	19.450	22.789	22.789	Bundle - kg
60.000	60.000	60.000	60.000	56.161	56.161	Pallet - m <sup>2</sup>
1,167.000	1,167.000	1,167.000	1,167.000	1,093.872	1,093.872	Pallet - kg
Bla	Bla	Bla	Bla	Bla	Bla	Product standard
R12V4	R12V8	R13	R13V10	R10	R11/B	Slip resistance
2	2	2	2	2	2	Stress group
<b>620290-070</b>	<b>620296-070</b>			<b>620241-070</b>		titanit <input type="checkbox"/> V1
Price gr. A85 (m <sup>2</sup> )	Price gr. A127 (m <sup>2</sup> )			Price gr. A43 (m <sup>2</sup> )		
<b>620290-072</b>	<b>620296-072</b>	<b>620480-072</b>	<b>620490-072</b>	<b>620241-072</b>	<b>620245-072</b>	anthracite <input type="checkbox"/> V1
Price gr. A85 (m <sup>2</sup> )	Price gr. A127 (m <sup>2</sup> )	Price gr. A142 (m <sup>2</sup> )	Price gr. A142 (m <sup>2</sup> )	Price gr. A43 (m <sup>2</sup> )	Price gr. A61 (m <sup>2</sup> )	
<b>620290-073</b>				<b>620241-073</b>		medium grey <input type="checkbox"/> V1
Price gr. A85 (m <sup>2</sup> )				Price gr. A43 (m <sup>2</sup> )		
<b>620290-075</b>	<b>620296-075</b>	<b>620480-075</b>	<b>620490-075</b>	<b>620241-075</b>		chalk <input type="checkbox"/> V1
Price gr. A85 (m <sup>2</sup> )	Price gr. A127 (m <sup>2</sup> )	Price gr. A142 (m <sup>2</sup> )	Price gr. A142 (m <sup>2</sup> )	Price gr. A43 (m <sup>2</sup> )		



<sup>2</sup> On request, also available in a thickness of 10.5 mm

Floor Tiles<sup>1</sup>

Skirting, cut

Stair Tiles<sup>2</sup>

30 x 60 cm

30 x 60 cm

7 x 20 cm

7 x 30 cm

30 x 30 cm



	Micro		Micro		Micro	
Nom. dim. - cm/in	<b>30 x 60</b> / 12 x 24	<b>30 x 60</b> / 12 x 24	<b>7 x 20</b> / 2 13/16 x 8	<b>7 x 30</b> / 2 13/16 x 12	<b>30 x 30</b> / 12 x 12	
Work size	297 x 597 x 9 mm	297 x 597 x 9 mm	70 x 197 x 9.0 mm	70 x 297 x 9.0 mm	297 x 297 x 9.0 mm	
Surface	smooth, matt	smooth, matt	smooth, matt	smooth, matt	smooth, matt	
m <sup>2</sup> /m - pieces	5.556/m <sup>2</sup>	5.556/m <sup>2</sup>	5.000/m	3.333/m	3.333/m	
m <sup>2</sup> /m - kg	19.907/m <sup>2</sup>	19.907/m <sup>2</sup>	1.400/m	1.399/m	5.906/m	
Bundle - pieces	7	7	60	50	11	
Bundle - m <sup>2</sup> /m	1.260 m <sup>2</sup>	1.260 m <sup>2</sup>	12.000 m	15.001 m	3.300 m	
Bundle - kg	25.081	25.081	16.800	21.000	19.492	
Pallet - m <sup>2</sup>	50.396	50.396				
Pallet - kg	1,003.240	1,003.240				
Product standard	Bla	Bla	Bla	Bla	Bla	
Slip resistance	R10/A	R11/B			R10	
Stress group	2	2			2	
titanit	<b>436100</b> Price gr. <b>A88</b> (m <sup>2</sup> )	<b>436104</b> Price gr. <b>A115</b> (m <sup>2</sup> )	<b>600334-070</b> Price gr. <b>A409</b> (pce.)	<b>600384-070</b> Price gr. <b>A410</b> (pce.)	<b>600499-070</b> Price gr. <b>A425</b> (pce.)	
anthracite	<b>436101</b> Price gr. <b>A88</b> (m <sup>2</sup> )	<b>436105</b> Price gr. <b>A115</b> (m <sup>2</sup> )	<b>600334-072</b> Price gr. <b>A409</b> (pce.)	<b>600384-072</b> Price gr. <b>A410</b> (pce.)	<b>600499-072</b> Price gr. <b>A425</b> (pce.)	
medium grey	<b>436102</b> Price gr. <b>A88</b> (m <sup>2</sup> )	<b>436106</b> Price gr. <b>A115</b> (m <sup>2</sup> )	<b>600334-073</b> Price gr. <b>A409</b> (pce.)	<b>600384-073</b> Price gr. <b>A410</b> (pce.)	<b>600499-073</b> Price gr. <b>A425</b> (pce.)	
chalk	<b>436103</b> Price gr. <b>A88</b> (m <sup>2</sup> )	<b>436107</b> Price gr. <b>A115</b> (m <sup>2</sup> )	<b>600334-075</b> Price gr. <b>A409</b> (pce.)	<b>600384-075</b> Price gr. <b>A410</b> (pce.)	<b>600499-075</b> Price gr. <b>A425</b> (pce.)	



Cove Skirting<sup>3</sup>

Internal Corner for Cove Skirting<sup>3/4</sup>

External Corner for Cove Skirting<sup>3/4</sup>

Shower Tub System<sup>5</sup>

10 x 10 cm

10 x 15 cm

10 x 20 cm

10 x 10 cm

10 x 10 cm



	Softcorn Strip			Softcorn Corner	
Nom. dim. - cm/in	<b>10 x 10</b> / 4 x 4	<b>10 x 15</b> / 4 x 6	<b>10 x 20</b> / 4 x 8		
Work size	100 x 97 x 6.0 mm	102 x 147 x 9 mm	102 x 197 x 9.0 mm	102 x 20 x 9.0 mm	102 x 35 x 9.0 mm
Surface	smooth, matt	smooth, matt	smooth, matt	smooth, matt	smooth, matt
m - pieces	10.000	6.667	5.000		
m/pce. - kg	1.500/m	2.000/m	2.000/m	0.080/Stück	0.080/Stück
Bundle - pieces	40	24	20	18	12
Bundle - m	4.000	3.600	4.000	1.440	0.960
Bundle - kg	6.000	7.200	8.000		
Pallet - m					
Pallet - kg					
Product standard	Bla	Bla	Bla	Bla	Bla
Slip resistance	R10/B	R10/A	R10/A		
titanit	<b>600450-070</b> Price gr. <b>A409</b> (pce.)	<b>600430-070-71</b> Price gr. <b>A413</b> (pce.)	<b>600420-070</b> Price gr. <b>A413</b> (pce.)	<b>600416-070</b> Price gr. <b>A416</b> (pce.)	<b>600417-070</b> Price gr. <b>A416</b> (pce.)
anthracite	<b>600450-072</b> Price gr. <b>A409</b> (pce.)	<b>600430-072-71</b> Price gr. <b>A413</b> (pce.)	<b>600420-072</b> Price gr. <b>A413</b> (pce.)	<b>600416-072</b> Price gr. <b>A416</b> (pce.)	<b>600417-072</b> Price gr. <b>A416</b> (pce.)
mid-grey	<b>600450-073</b> Price gr. <b>A409</b> (pce.)		<b>600420-073</b> Price gr. <b>A413</b> (pce.)	<b>600416-073</b> Price gr. <b>A416</b> (pce.)	<b>600417-073</b> Price gr. <b>A416</b> (pce.)
chalk	<b>600450-075</b> Price gr. <b>A409</b> (pce.)	<b>600430-075-71</b> Price gr. <b>A413</b> (pce.)	<b>600420-075</b> Price gr. <b>A413</b> (pce.)	<b>600416-075</b> Price gr. <b>A416</b> (pce.)	<b>600417-075</b> Price gr. <b>A416</b> (pce.)
					<b>600442-070</b> Price gr. <b>A425</b> (pce.)
					<b>600442-072</b> Price gr. <b>A425</b> (pce.)
					<b>600442-073</b> Price gr. <b>A425</b> (pce.)
					<b>600442-075</b> Price gr. <b>A425</b> (pce.)
					<b>600443-070</b> Price gr. <b>A451</b> (pce.)
					<b>600443-072</b> Price gr. <b>A451</b> (pce.)
					<b>600443-073</b> Price gr. <b>A451</b> (pce.)
					<b>600443-075</b> Price gr. <b>A451</b> (pce.)

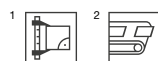

<sup>3</sup> For details, refer to page 536 and the following  
<sup>4</sup> Fitting to cove skirting 10 x 15 cm and 10 x 20 cm.  
<sup>5</sup> For details, refer to page 534



Wall/Floor Tiles

25 x 12,5 cm



25 x 12,5 cm



25 x 12,5 cm



(8 mm thick)

(6 mm thick)

(8 mm thick)

				38110	18120	8110			Model number
				<b>25 x 12.5</b> / 10 x 5	<b>25 x 12.5</b> / 10 x 5	<b>25 x 12.5</b> / 10 x 5			Nom. dim. - cm/in
				244 x 119 x 8 mm	244 x 119 x 6 mm	240 x 115 x 8 mm			Work size
				smooth	smooth	smooth			Surface
				32.000	32.000	32.000			m <sup>2</sup> - pieces
				15.680	12.160	14.720			m <sup>2</sup> - kg
				33	44	33			Bundle - pieces
				1.031	1.375	1.000			Bundle - m <sup>2</sup>
				16.170	16.720	15.180			Bundle - kg
				86.625	115.500	84.000			Pallet - m <sup>2</sup>
				1,358.280	1,404.480	1,275.120			Pallet - kg
				Alb	Alb	Alb			Product standard
				<b>700-38110</b>	<b>700-18120</b>	<b>75917-8110</b>	3		
				Price gr. <b>A73</b> (m <sup>2</sup> )	Price gr. <b>A73</b> (m <sup>2</sup> )	Price gr. <b>A61</b> (m <sup>2</sup> )			white, glossy <input type="checkbox"/> VO
				<b>701-38110</b>	<b>701-18120</b>	<b>75918-8110</b>	4		
				Price gr. <b>A73</b> (m <sup>2</sup> )	Price gr. <b>A73</b> (m <sup>2</sup> )	Price gr. <b>A61</b> (m <sup>2</sup> )			white, matt <input type="checkbox"/> VO
					<b>509-18120</b>		4		grey
					Price gr. <b>A112</b> (m <sup>2</sup> )				transparent matt <input type="checkbox"/> VO
					<b>711-18120</b>		4		light-grey
					Price gr. <b>A112</b> (m <sup>2</sup> )				matt <input type="checkbox"/> VO
				<b>703-38110</b>	<b>703-18120</b>		4		
				Price gr. <b>A112</b> (m <sup>2</sup> )	Price gr. <b>A112</b> (m <sup>2</sup> )				light-sahara matt <input type="checkbox"/> VO
					<b>732-18120</b>		3		
					Price gr. <b>A112</b> (m <sup>2</sup> )				soft azure glossy <input type="checkbox"/> VO
						<b>71152-8110</b>	3		light-blue
						Price gr. <b>A112</b> (m <sup>2</sup> )			glossy <input type="checkbox"/> VO
					<b>563-18120</b>		1		azure dark
					Price gr. <b>A112</b> (m <sup>2</sup> )				glossy <input type="checkbox"/> VO





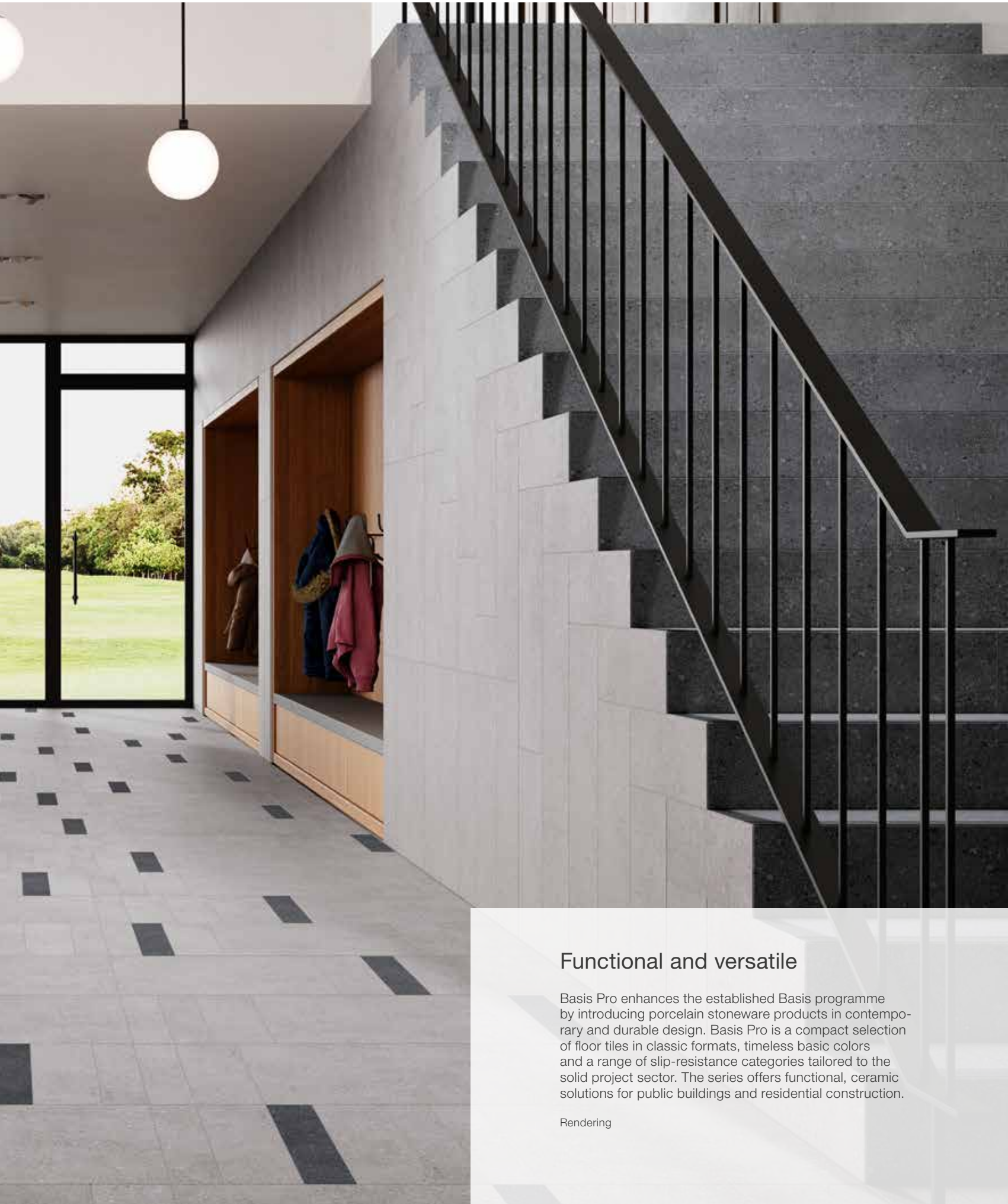

## Functional and versatile

Basis Pro enhances the established Basis programme by introducing porcelain stoneware products in contemporary and durable design. Basis Pro is a compact selection of floor tiles in classic formats, timeless basic colors and a range of slip-resistance categories tailored to the solid project sector. The series offers functional, ceramic solutions for public buildings and residential construction.

Rendering



sand-beige



ash-brown



concrete-grey



basalt

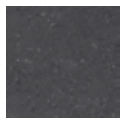

anthracite

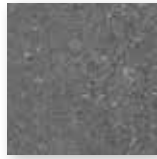

Floor tile 15 x 15 cm, 6 x 6 in smooth, R10/B

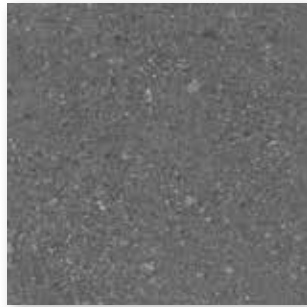

Floor tile 30 x 30 cm, 12 x 12 in, smooth, R10/A  
Floor tile 30 x 30 cm, 12 x 12 in, smooth, R11/B



Floor tile 10 x 60 cm, 4 x 24 in, smooth, R10/A

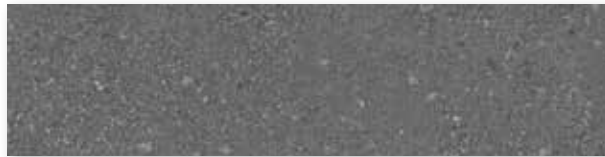

Floor tile 15 x 60 cm, 6 x 24 in, smooth, R10/A

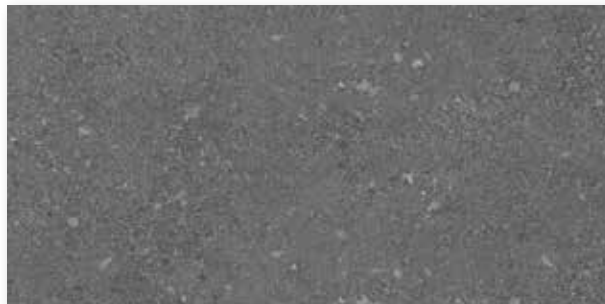

Floor tile 30 x 60 cm, 12 x 24 in, smooth, R10/A  
Floor tile 30 x 60 cm, 12 x 24 in, smooth, R11/B  
Floor tile 30 x 60 cm, 12 x 24 in, smooth, R12/C

Mosaic  
5 x 5 cm, 2 x 2 in

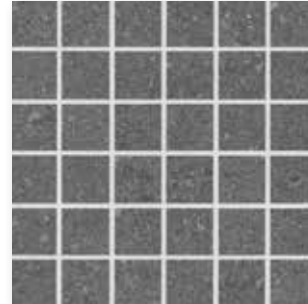

Mosaic sheet 30 x 30 cm, 12 x 12 in, smooth, R10/B



Mosaics glued thermoplastically on back of Agrob Buchtal can be used not only in dry zones but also without any problems in underwater areas (e.g. swimming pools/whirlpools) as well as in permanently wet areas (e.g. pool surrounds/showers).

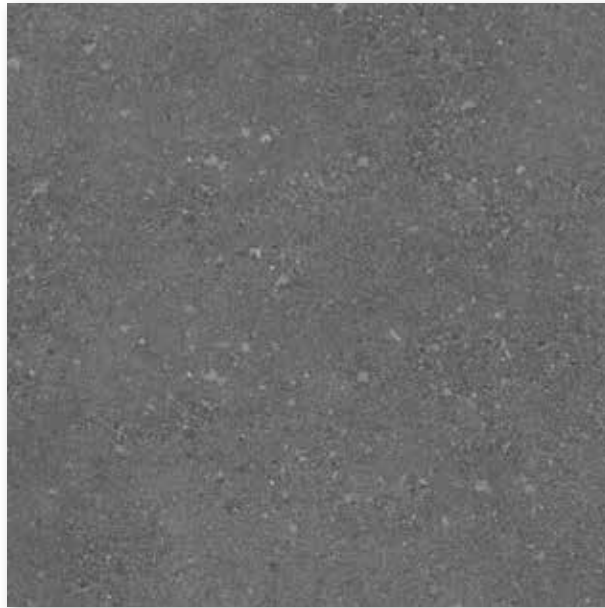

Floor tile 60 x 60 cm, 24 x 24 in, smooth, R10/A

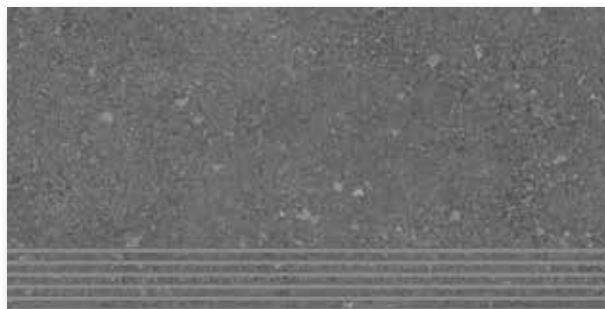

Stair tile 30 x 60 cm (with grooves), 12 x 24 in, smooth, R10/A



Skirting, rounded 7 x 60 cm, 2 13/16 x 24 in, smooth



Cove skirting 10 x 30 cm, 4 x 12 in, smooth, R10/A

Mosaic

Floor Tiles

5 x 5 cm<sup>1</sup>



15 x 15 cm



30 x 30 cm



30 x 30 cm



30 x 30 cm<sup>3/4</sup>



10 x 60 cm<sup>2/3</sup>



15 x 60 cm<sup>2/3</sup>

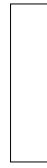

protected

Sheet 297 x 297 mm

extra thick

Oblong format

Oblong format

Nom. dim. - cm/in	5 x 5 / 2 x 2	15 x 15 / 6 x 6	30 x 30 / 12 x 12	30 x 30 / 12 x 12	30 x 30 / 12 x 12	10 x 60 / 4 x 24	15 x 60 / 6 x 24
Work size	47 x 47 x 6.5 mm	147 x 147 x 9 mm	297 x 297 x 9 mm	297 x 297 x 9 mm	297 x 297 x 14 mm	97 x 597 x 9 mm	147 x 597 x 9 mm
Surface	smooth, matt	smooth, matt	smooth, matt	smooth, matt	smooth, matt	smooth, matt	smooth, matt
m <sup>2</sup> - pieces	11 sheets	44.444	11.111	11.111	11.337	16.667	11.111
m <sup>2</sup> - kg	12.331	19.822	19.478	19.478	32.027	20.283	19.900
Bundle - pieces	11 sheets	32	13	13	8	17	13
Bundle - m <sup>2</sup>	1.000	0.720	1.170	1.170	0.706	1.020	1.170
Bundle - kg	12.331	14.272	22.789	22.789	22.600	20.689	23.283
Pallet - m <sup>2</sup>	64.000	57.601	56.161	56.161	33.871	40.799	46.800
Pallet - kg	789.184	1,141.760	1,093.880	1,093.872	1,084.800	827.560	931.311
Product standard	Bla	Bla	Bla	Bla	Bla	Bla	Bla
Slip resistance	R10/B	R10/B	R10/A	R11/B	R10	R10/A	R10/A
Stress group	1	2	2	2	4	2	2
	<b>430901</b>	<b>430906</b>	<b>430911</b>	<b>431045</b>		<b>430916</b>	<b>430921</b>
	Price gr. <b>A181</b> (m <sup>2</sup> )	Price gr. <b>A109</b> (m <sup>2</sup> )	Price gr. <b>A61</b> (m <sup>2</sup> )	Price gr. <b>A61</b> (m <sup>2</sup> )		Price gr. <b>A169</b> (m <sup>2</sup> )	Price gr. <b>A169</b> (m <sup>2</sup> )
sand-beige <input type="checkbox"/>	<b>430902</b>	<b>430907</b>	<b>430912</b>	<b>431046</b>		<b>430917</b>	<b>430922</b>
	Price gr. <b>A181</b> (m <sup>2</sup> )	Price gr. <b>A109</b> (m <sup>2</sup> )	Price gr. <b>A61</b> (m <sup>2</sup> )	Price gr. <b>A61</b> (m <sup>2</sup> )		Price gr. <b>A169</b> (m <sup>2</sup> )	Price gr. <b>A169</b> (m <sup>2</sup> )
ash-brown <input type="checkbox"/>	<b>430903</b>	<b>430908</b>	<b>430913</b>	<b>431047</b>	430993	<b>430918</b>	<b>430923</b>
	Price gr. <b>A181</b> (m <sup>2</sup> )	Price gr. <b>A109</b> (m <sup>2</sup> )	Price gr. <b>A61</b> (m <sup>2</sup> )	Price gr. <b>A61</b> (m <sup>2</sup> )		Price gr. <b>A169</b> (m <sup>2</sup> )	Price gr. <b>A169</b> (m <sup>2</sup> )
concrete-grey <input type="checkbox"/>	<b>430904</b>	<b>430909</b>	<b>430914</b>	<b>431048</b>		<b>430919</b>	<b>430924</b>
	Price gr. <b>A181</b> (m <sup>2</sup> )	Price gr. <b>A109</b> (m <sup>2</sup> )	Price gr. <b>A61</b> (m <sup>2</sup> )	Price gr. <b>A61</b> (m <sup>2</sup> )		Price gr. <b>A169</b> (m <sup>2</sup> )	Price gr. <b>A169</b> (m <sup>2</sup> )
basalt <input type="checkbox"/>	<b>430905</b>	<b>430910</b>	<b>430915</b>	<b>431049</b>		<b>430920</b>	<b>430925</b>
	Price gr. <b>A181</b> (m <sup>2</sup> )	Price gr. <b>A109</b> (m <sup>2</sup> )	Price gr. <b>A61</b> (m <sup>2</sup> )	Price gr. <b>A61</b> (m <sup>2</sup> )		Price gr. <b>A169</b> (m <sup>2</sup> )	Price gr. <b>A169</b> (m <sup>2</sup> )
anthracite <input type="checkbox"/>							



<sup>4</sup> Prices are calculated project-specifically

### Floor Tiles

30 x 60 cm<sup>1</sup>



30 x 60 cm<sup>2/3/4</sup>



30 x 60 cm<sup>1</sup>



30 x 60 cm<sup>1</sup>



60 x 60 cm<sup>1</sup>



60 x 60 cm<sup>2/3/4</sup>



protected

	<i>extra thick</i>				<i>extra thick</i>		
	<b>30 x 60 / 12 x 24</b>	<b>30 x 60 / 12 x 24</b>	<b>30 x 60 / 12 x 24</b>	<b>30 x 60 / 12 x 24</b>	<b>60 x 60 / 24 x 24</b>	<b>60 x 60 / 24 x 24</b>	Nom. dim. - <b>cm/in</b>
	297 x 597 x 9 mm	300 x 600 x 14 mm	297 x 597 x 9 mm	297 x 597 x 9 mm	597 x 597 x 9 mm	600 x 600 x 14 mm	Work size
	smooth, matt	smooth, matt	smooth, matt	smooth, matt	smooth, matt	smooth, matt	Surface
	5.556	5.589	5.556	5.556	2.778	2.778	m <sup>2</sup> - pieces
	19.907	32.159	19.907	19.907	20.371	31.669	m <sup>2</sup> - kg
	7	4	7	7	3	2	<b>Bundle</b> - pieces
	1.260	0.716	1.260	1.260	1.080	0.720	<b>Bundle</b> - m <sup>2</sup>
	25.081	23.016	25.081	25.081	21.999	22.800	<b>Bundle</b> - kg
	50.396	28.628	50.396	50.396	45.356	30.238	<b>Pallet</b> - m <sup>2</sup>
	1,003.240	920.640	1,003.240	1,003.240	923.958	957.600	<b>Pallet</b> - kg
	Bla	Bla	Bla	Bla	Bla	Bla	Product standard
	R10/A	R10	R11/B	R12/C	R10/A	R10	Slip resistance
	2	3 - 4	2	2	2	3 - 4	Stress group
	<b>430926</b>	430997	<b>430931</b>	<b>430936</b>	<b>430941</b>	430979	sand-beige <input type="checkbox"/> V2
	Price gr. <b>A106</b> (m <sup>2</sup> )		Price gr. <b>A106</b> (m <sup>2</sup> )	Price gr. <b>A124</b> (m <sup>2</sup> )	Price gr. <b>A121</b> (m <sup>2</sup> )		
	<b>430927</b>	430996	<b>430932</b>	<b>430937</b>	<b>430942</b>	430978	ash-brown <input type="checkbox"/> V2
	Price gr. <b>A106</b> (m <sup>2</sup> )		Price gr. <b>A106</b> (m <sup>2</sup> )	Price gr. <b>A124</b> (m <sup>2</sup> )	Price gr. <b>A121</b> (m <sup>2</sup> )		
	<b>430928</b>	430995	<b>430933</b>	<b>430938</b>	<b>430943</b>	430977	concrete-grey <input type="checkbox"/> V2
	Price gr. <b>A106</b> (m <sup>2</sup> )		Price gr. <b>A106</b> (m <sup>2</sup> )	Price gr. <b>A124</b> (m <sup>2</sup> )	Price gr. <b>A121</b> (m <sup>2</sup> )		
	<b>430929</b>		<b>430934</b>	<b>430939</b>	<b>430944</b>		basalt <input type="checkbox"/> V2
	Price gr. <b>A106</b> (m <sup>2</sup> )		Price gr. <b>A106</b> (m <sup>2</sup> )	Price gr. <b>A124</b> (m <sup>2</sup> )	Price gr. <b>A121</b> (m <sup>2</sup> )		
	<b>430930</b>		<b>430935</b>	<b>430940</b>	<b>430945</b>		anthracite <input type="checkbox"/> V2
	Price gr. <b>A106</b> (m <sup>2</sup> )		Price gr. <b>A106</b> (m <sup>2</sup> )	Price gr. <b>A124</b> (m <sup>2</sup> )	Price gr. <b>A121</b> (m <sup>2</sup> )		

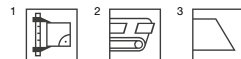

<sup>4</sup> Prices are calculated project-specifically



Cove Skirting, decorated<sup>3/4</sup>    Stair Tile<sup>1/2</sup>    Skirting, rounded<sup>1</sup>

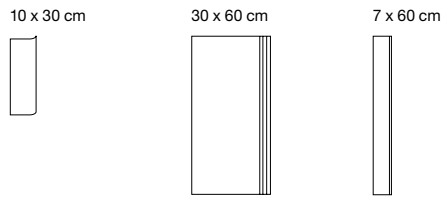

Nom. dim. - cm/in	10 x 30 / 4 x 12	30 x 60 / 12 x 24	7 x 60 / 2 13/16 x 24			
Work size	102 x 297 x 9 mm	297 x 597 x 9 mm	70 x 597 x 9 mm			
Surface	smooth, matt	smooth, matt	smooth, matt			
m - pieces	3.333	1.667	1.667			
m - kg	1.999	5.973	1.357			
<b>Bundle</b> - pieces	16	7	15			
<b>Bundle</b> - m	4.800	4.199	8.998			
<b>Bundle</b> - kg	9.600	25.081	12.210			
<b>Pallet</b> - m <sup>2</sup>						
<b>Pallet</b> - kg						
Product standard	Bla	Bla	Bla			
Slip resistance	R10/A	R10/A				
Stress group		2				
	<b>430946</b>	<i>430951</i>	<b>430956</b>			
sand-beige <input type="checkbox"/> V2	Price gr. <b>A422</b> (pce.)	<i>Price gr. A456 (pce.)</i>	Price gr. <b>A438</b> (pce.)			
	<b>430947</b>	<i>430952</i>	<b>430957</b>			
ash-brown <input type="checkbox"/> V2	Price gr. <b>A422</b> (pce.)	<i>Price gr. A456 (pce.)</i>	Price gr. <b>A438</b> (pce.)			
	<b>430948</b>	<i>430953</i>	<b>430958</b>			
concrete-grey <input type="checkbox"/> V2	Price gr. <b>A422</b> (pce.)	<i>Price gr. A456 (pce.)</i>	Price gr. <b>A438</b> (pce.)			
	<b>430949</b>	<i>430954</i>	<b>430959</b>			
basalt <input type="checkbox"/> V2	Price gr. <b>A422</b> (pce.)	<i>Price gr. A456 (pce.)</i>	Price gr. <b>A438</b> (pce.)			
	<b>430950</b>	<i>430955</i>	<b>430960</b>			
anthracite <input type="checkbox"/> V2	Price gr. <b>A422</b> (pce.)	<i>Price gr. A456 (pce.)</i>	Price gr. <b>A438</b> (pce.)			

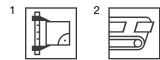

<sup>3</sup> For details, refer to page 536

<sup>4</sup> Color deviations compared to the adjoining covering due to production are no reason for complaint in case of horizontal laying.



Rendering



Maximiliancenter at the central railway station, Bonn, Germany / Architect: Forum Architekten & Planners BV  
Series: Orientation Aids for the Blind / Photo: Jochen Stüber







chalk



graphite



Guide tile 30 x 30 cm, 12 x 12 in, ribbed structure, R11



Guide tile 30 x 30 cm, 12 x 12 in, knob structure, R11



Guide tile 30 x 30 cm, 12 x 12 in, smooth, R11

**Area Pro**



platinum



anthracite



Guide tile 30 x 30 cm, 12 x 12 in, ribbed structure, R11

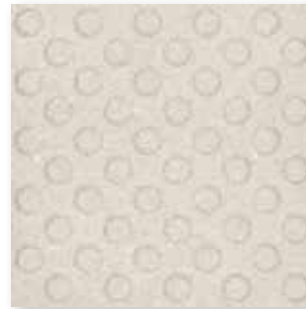

Guide tile 30 x 30 cm, 12 x 12 in, knob structure, R11



Guide tile 30 x 30 cm, 12 x 12 in, smooth, R11

**Knob structure**

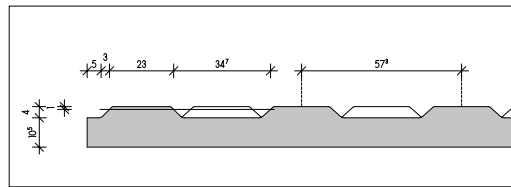
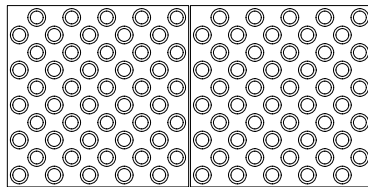

M.: 2:1

**Ribbed structure**

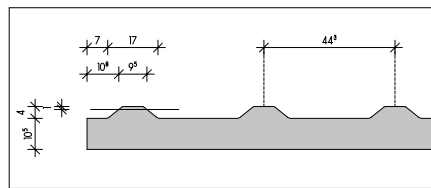
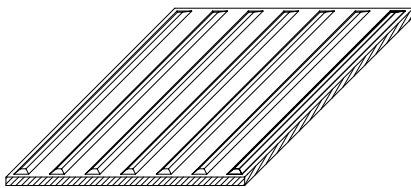

M.: 2:1

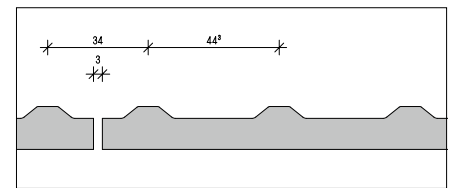

M.: 2:1

The system meets the requirements of DIN 32984. The luminance contrast between color chalk and graphite is 0.7 and thus clearly surpasses the requirements.

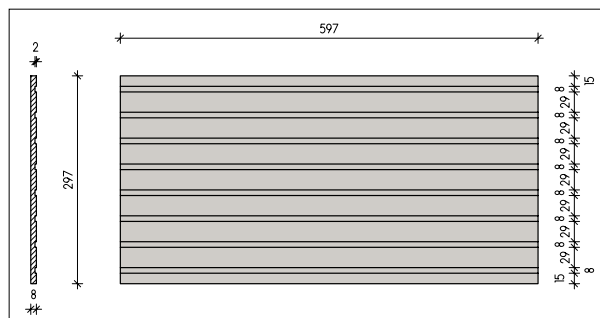

Milled guide tile from any floor tiles on request.

Guide Tiles

Floor Tile

30 x 30 cm



30 x 30 cm



30 x 30 cm



protected

				30 x 30 / 12 x 12	30 x 30 / 12 x 12	30 x 30 / 12 x 12	Nom. dim. - cm/in
				297 x 297 x 10.5 mm	297 x 297 x 10.5 mm	297 x 297 x 10.5 mm	Work size
				ribbed structure	knob structure	smooth, matt	Surface
				3.333/m	3.333/m	11.111/m <sup>2</sup>	m/m <sup>2</sup> - pieces
				7.999/m	7.999/m	23.144/m <sup>2</sup>	m/m <sup>2</sup> - kg
				8	8	11	Bundle - pieces
				2.400 m	2.400 m	0.990 m <sup>2</sup>	Bundle - m/m <sup>2</sup>
				19.200	19.200	22.913	Bundle - kg
						47.520	Pallet - m <sup>2</sup>
						1,099.824	Pallet - kg
				Bla	Bla	Bla	Product standard
				R11	R11	R11	Slip resistance
				3	3	3	Stress group
				<b>600356-103-70</b>	<b>600355-103-70</b>	<b>600357-103-70</b>	chalk <input type="checkbox"/> V0
				Price gr. <b>A455</b> (pce.)	Price gr. <b>A539</b> (pce.)	Price gr. <b>A190</b> (m <sup>2</sup> )	
				<b>600356-106-70</b>	<b>600355-106-70</b>	<b>600357-106-70</b>	graphite <input type="checkbox"/> V0
				Price gr. <b>A455</b> (pce.)	Price gr. <b>A539</b> (pce.)	Price gr. <b>A190</b> (m <sup>2</sup> )	
				<b>430304H-R</b>	<b>430304H-N</b>	<b>430304-N</b>	Area Pro
				Price gr. <b>A455</b> (pce.)	Price gr. <b>A539</b> (pce.)	Price gr. <b>A190</b> (m <sup>2</sup> )	anthracite <input type="checkbox"/> V2
				<b>430312H-R</b>	<b>430312H-N</b>	<b>430312-N</b>	Area Pro
				Price gr. <b>A455</b> (pce.)	Price gr. <b>A539</b> (pce.)	Price gr. <b>A190</b> (m <sup>2</sup> )	platinum <input type="checkbox"/> V2





Floor tile 15.4 x 15.4 cm, 6 3/16 x 6 3/16 in, ribbed structure, chalk, R11



Floor tile 15.4 x 15.4 cm, 6 3/16 x 6 3/16 in, ribbed structure, anthracite, R11

Guide tile: 6635

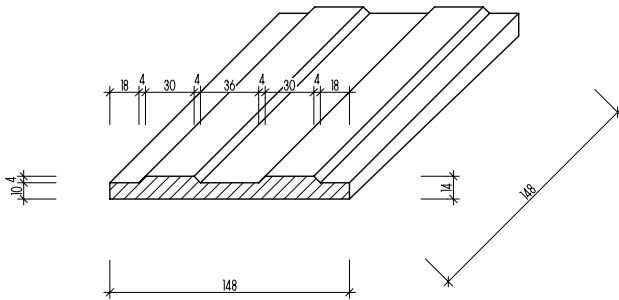

Guide tile: 6636

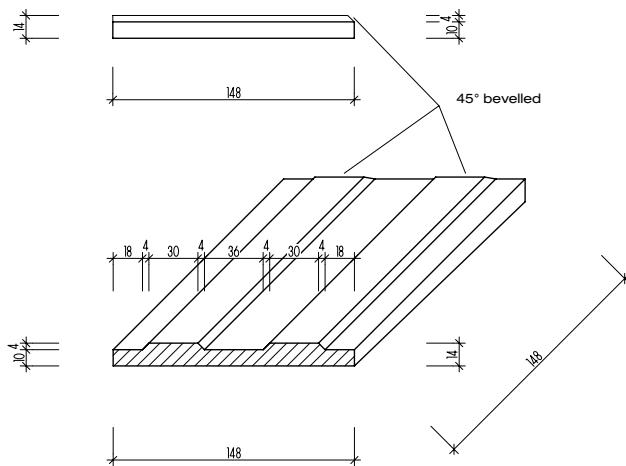

Guide Tiles<sup>1/2/3</sup>

15,4 x 15,4 cm



ribbed structure

15,4 x 15,4 cm



bevelled on one side,  
ribbed structure

					6635	6636	Model number
					15.4 x 15.4 / 63/16 x 63/16	15.4 x 15.4 / 63/16 x 63/16	Nom. dim. - cm/in
					148 x 148 x 10 mm	148 x 148 x 10 mm	Work size
					ribbed structure	ribbed structure	Surface
					6.494	6.494	m - pieces
					3.318	3.318	m - kg
					20	20	Bundle - pieces
					3.080	3.080	Bundle - m
					10.220	10.220	Bundle - kg
							Pallet - m
							Pallet - kg
					Alb	Alb	Product standard
					R11	R11	Slip resistance
					3	3	Stress group
					103197-6635	103197-6636	
					Price gr. A428 (pce.)	Price gr. A442 (pce.)	chalk <input type="checkbox"/>
					101630-6635	101630-6636	
					Price gr. A428 (pce.)	Price gr. A442 (pce.)	anthracite <input type="checkbox"/>



<sup>3</sup> Short edge rectified









## Noble marble look

The natural expression of Italian marble and the generous format make Bliss truly special. The combination of the basic tiles with the freshly colored Paradise surface décor is particularly striking. The basic tiles harmonize with various floor tile series and are Hytect-coated, making them especially hygienic.

Rendering



Wall tile 35 x 100 cm, 14 x 40 in, white calacatta, smooth

## Decoration Elements



Decorative tile Paradise 35 x 100 cm, 14 x 40 in, green-blue Mix, smooth

Wall Tiles<sup>1</sup>

Decoration  
Elements<sup>1/2/3</sup>

35 x 100 cm



35 x 100 cm

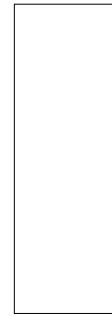

35 x 100 cm



Decorative tile Paradise

				35 x 100 / 14 x 40	35 x 100 / 14 x 40	35 x 100 / 14 x 40	
				347 x 997 x 6 mm	347 x 997 x 6 mm	347 x 997 x 6 mm	Nom. dim - cm/in
				smooth, silky-matt	smooth, glossy	smooth, silky-matt	Work size
				2.857	2.857	2.857	Surface
				10.108	10.108	10.108	m <sup>2</sup> - pieces
				5	5	5	m <sup>2</sup> - kg
				1.750	1.750	1.750	Bundle - pieces
				17.690	17.690	17.690	Bundle - m <sup>2</sup>
				70.004	70.004	70.004	Bundle - kg
				707.600	707.600	707.600	Pallet - m <sup>2</sup>
				BIII	BIII	BIII	Pallet - kg
				<b>363428H</b>	<b>363429H</b>		Product standard
				Price gr. C134 (m <sup>2</sup> )	Price gr. C134 (m <sup>2</sup> )		white calacatta <input type="checkbox"/> V3
						<b>363430H</b>	green-blue Mix <input type="checkbox"/> V4
						Price gr. C143 (m <sup>2</sup> )	



<sup>2</sup> Decoration elements only available in full boxes.

<sup>3</sup> The decoration you have chosen is a high-quality product made of glazed earthenware. The decoration consists of different individual pictures. The connections of the individual pictures are deliberately designed freely and thus do not connect in the continuous laying. The composition of the motifs in the box may vary due to production reasons..





## Inspired by wood

With its subtle evocation of wood surfaces, Cedra is the perfect choice for a homely bathroom design. The two wall tile colors available in two formats can be harmoniously combined with the borders. These borders, available with or without porcelain stoneware inlays, create visual accents and echo the three classic colors of the floor tiles. Particularly practical: in addition to the floor tile, the shower area can be continued with a matching mosaic in R10/B. Thanks to their Hytect surface, the wall tiles are especially easy to clean.

Rendering



Wall tile 30 x 60 cm, 12 x 24 in, white-cream, smooth



Wall tile 30 x 60 cm, 12 x 24 in, beige, smooth

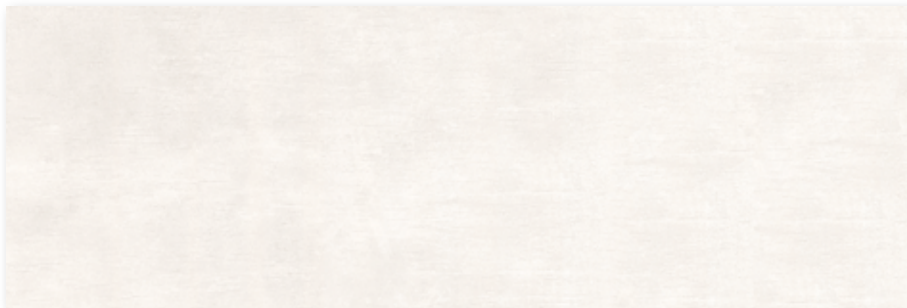

Wall tile 30 x 90 cm, 12 x 36 in, white-cream, smooth



Wall tile 30 x 90 cm, 12 x 36 in, beige, smooth

## Decoration Elements



Border with porcelain stoneware insert 10 x 60 cm, 4 x 24 in, grey, smooth



Border with porcelain stoneware insert 10 x 60 cm, 4 x 24 in, anthracite, smooth



Border with porcelain stoneware insert 10 x 60 cm, 4 x 24 in, mud, smooth



Border 10 x 60 cm, 4 x 24 in, grey, smooth



Border 10 x 60 cm, 4 x 24 in, anthracite, smooth

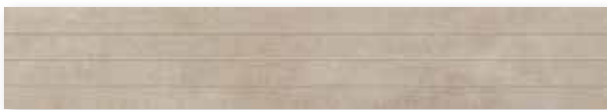

Border 10 x 60 cm, 4 x 24 in, mud, smooth

## Decoration Elements



Border with porcelain stoneware insert 10 x 90 cm, 4 x 36 in, grey, smooth



Border with porcelain stoneware insert 10 x 90 cm, 4 x 36 in, anthracite, smooth



Border with porcelain stoneware insert 10 x 90 cm, 4 x 36 in, mud, smooth



Border 10 x 90 cm, 4 x 36 in, grey, smooth



Border 10 x 90 cm, 4 x 36 in, anthracite, smooth



Border 10 x 90 cm, 4 x 36 in, mud, smooth



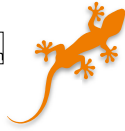

anthracite



grey



mud



Floor tile 30 x 60 cm, 12 x 24 in, smooth, R9



Skirting, rounded 7 x 60 cm, 2 13/16 x 24 in, smooth

## Mosaic 5 x 5 cm, 2 x 2 in

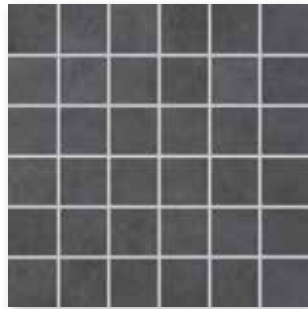

Mosaic sheet 30 x 30 cm, 12 x 12 in, anthracite, smooth, R10/B

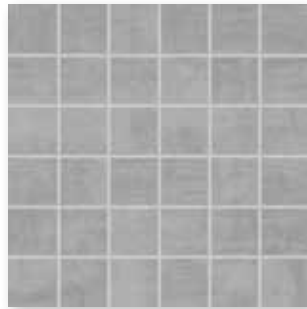

Mosaic sheet 30 x 30 cm, 12 x 12 in, grey, smooth, R10/B



Mosaic sheet 30 x 30 cm, 12 x 12 in, mud, smooth, R10/B

Mosaic: glass fibre net on reverse side,  
Sheet: 297 x 297 mm

Wall Tile

Decoration Elements<sup>2/3/4/5/6</sup>

30 x 60 cm



30 x 90 cm<sup>1</sup>

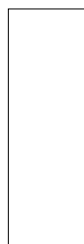

10 x 60 cm



10 x 60 cm



10 x 90 cm



10 x 90 cm



Nom. dim - cm/in	30 x 60 / 12 x 24	30 x 90 / 12 x 36	10 x 60 / 4 x 24	10 x 60 / 4 x 24	10 x 90 / 4 x 36	10 x 90 / 4 x 36
Work size	297 x 597 x 9 mm	297 x 897 x 10.5 mm	97 x 597 x 10.5 mm	97 x 597 x 10.5 mm	97 x 897 x 10.5 mm	97 x 897 x 10.5 mm
Surface	smooth, silky-matt	smooth, silky-matt	smooth, matt	smooth, matt	smooth, matt	smooth, matt
m <sup>2</sup> /m - pieces	5.556/m <sup>2</sup>	3.704/m <sup>2</sup>	1.667/m	1.667/m	1.111/m	1.111/m
m <sup>2</sup> /m - kg	14.946/m <sup>2</sup>	17.976/m <sup>2</sup>	2.167/m	2.167/m	2.166/m	2.166/m
Bundle - pieces	9	5	4	4	2	2
Bundle - m <sup>2</sup> /m	1.620 m <sup>2</sup>	1.350 m <sup>2</sup>	2.400 m	2.400 m	1.800 m	1.800 m
Bundle - kg	24.210	24.265	5.200	5.200	3.900	3.900
Pallet - m <sup>2</sup>	77.754	32.397				
Pallet - kg	1,162.080	582.360				
Product standard	BIII	BIII	Bla	Bla	Bla	Bla
	<b>281726</b>	<b>392720</b>				
	Price gr. <b>C89</b> (m <sup>2</sup> )	Price gr. <b>C149</b> (m <sup>2</sup> )				
	<b>281727</b>	<b>392721</b>				
	Price gr. <b>C89</b> (m <sup>2</sup> )	Price gr. <b>C149</b> (m <sup>2</sup> )				
white-cream <input type="checkbox"/>			<b>281728</b>	<b>281729</b>	<b>392723</b>	<b>392724</b>
			Price gr. <b>C474</b> (pce.)	Price gr. <b>C466</b> (pce.)	Price gr. <b>C491</b> (pce.)	Price gr. <b>C486</b> (pce.)
beige <input type="checkbox"/>			<b>281730</b>	<b>281731</b>	<b>392725</b>	<b>392726</b>
			Price gr. <b>C474</b> (pce.)	Price gr. <b>C466</b> (pce.)	Price gr. <b>C491</b> (pce.)	Price gr. <b>C486</b> (pce.)
grey <input type="checkbox"/>			<b>281732</b>	<b>281733</b>	<b>392727</b>	<b>392728</b>
			Price gr. <b>C474</b> (pce.)	Price gr. <b>C466</b> (pce.)	Price gr. <b>C491</b> (pce.)	Price gr. <b>C486</b> (pce.)
anthracite <input type="checkbox"/>						
mud <input type="checkbox"/>						

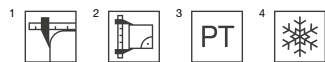

<sup>5</sup> Glass fibre net on reverse side  
<sup>6</sup> Decoration elements only available in full boxes.

Mosaic<sup>1/2</sup>

5 x 5 cm



Floor Tiles<sup>1</sup>

30 x 60 cm



Skirting,  
rounded<sup>1</sup>

7 x 60 cm



protected

Sheet: 297 x 297 mm

				<b>5 x 5</b> / 2 x 2	<b>30 x 60</b> / 12 x 24	<b>7 x 60</b> / 2 13/16 x 24	Nom. dim - cm/in
				47 x 47 x 10.5 mm	297 x 597 x 10.5 mm	70 x 597 x 10.5 mm	Work size
				smooth, matt	smooth, matt	smooth, matt	Surface
				11.111 sheets/m <sup>2</sup>	5.556/m <sup>2</sup>	1.667/m	m <sup>2</sup> /m - pieces
				22.222/m <sup>2</sup>	23.224/m <sup>2</sup>	1.584/m	m <sup>2</sup> /m - kg
				11 sheets	6	22	Bundle - pieces
				0.990 m <sup>2</sup>	1.080 m <sup>2</sup>	13.197 m	Bundle - m <sup>2</sup> /m
				22.000	25.080	20.900	Bundle - kg
				29.700	43.197		Pallet - m <sup>2</sup>
				660.000	1,003.200		Pallet - kg
				Bla	Bla	Bla	Product standard
				R10/B	R9		Slip resistance
				2	2		Stress group
				<b>433757</b>	<b>433692</b>	<b>433695</b>	anthracite <input type="checkbox"/> V2
				Price gr. <b>C314</b> (m <sup>2</sup> )	Price gr. <b>C116</b> (m <sup>2</sup> )	Price gr. <b>C440</b> (pce.)	
				<b>433756</b>	<b>433693</b>	<b>433696</b>	grey <input type="checkbox"/> V2
				Price gr. <b>C314</b> (m <sup>2</sup> )	Price gr. <b>C116</b> (m <sup>2</sup> )	Price gr. <b>C440</b> (pce.)	
				<b>433758</b>	<b>433694</b>	<b>433697</b>	mud <input type="checkbox"/> V3
				Price gr. <b>C314</b> (m <sup>2</sup> )	Price gr. <b>C116</b> (m <sup>2</sup> )	Price gr. <b>C440</b> (pce.)	



<sup>2</sup> Glass fibre net on reverse side





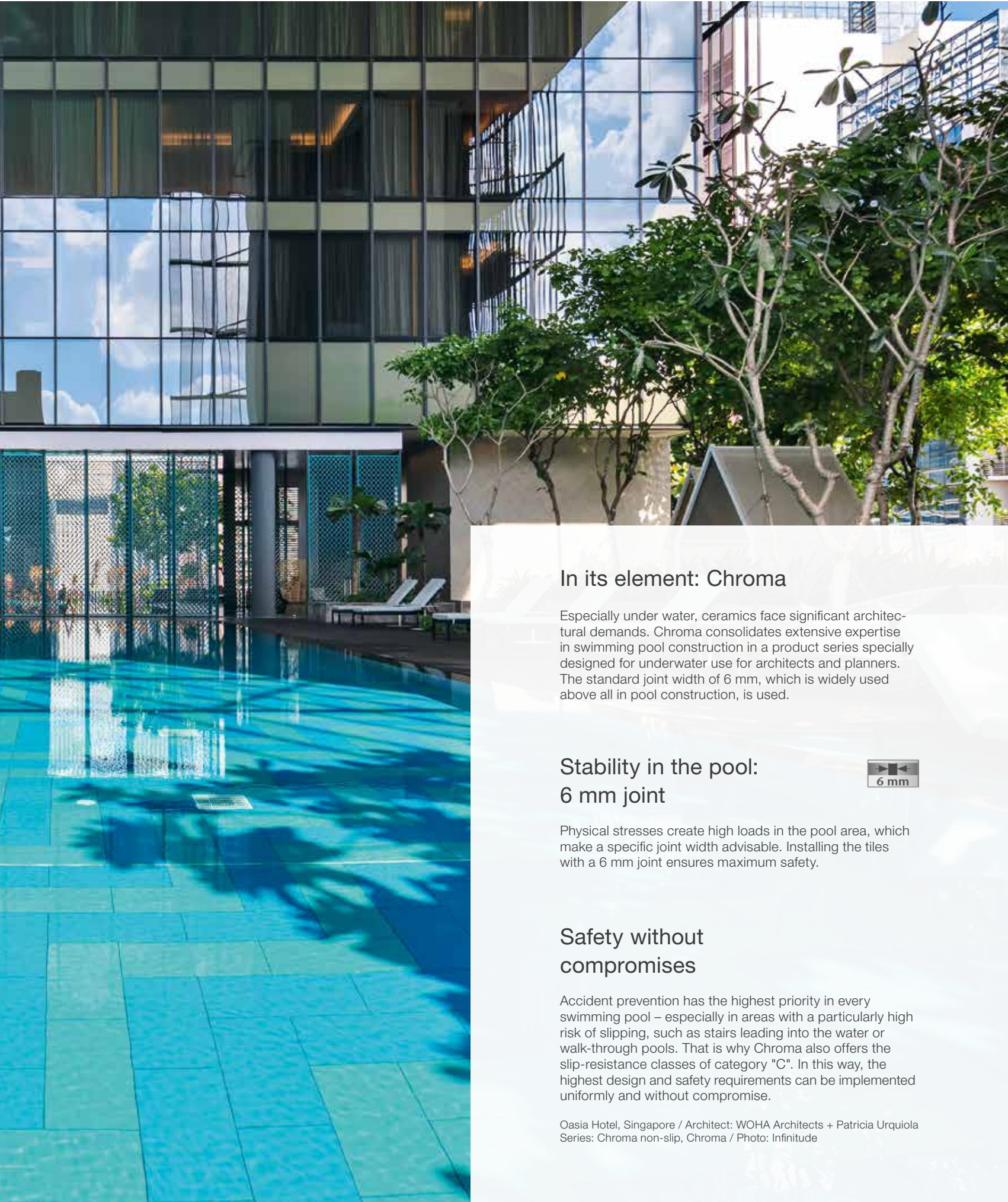

## In its element: Chroma

Especially under water, ceramics face significant architectural demands. Chroma consolidates extensive expertise in swimming pool construction in a product series specially designed for underwater use for architects and planners. The standard joint width of 6 mm, which is widely used above all in pool construction, is used.

## Stability in the pool: 6 mm joint



Physical stresses create high loads in the pool area, which make a specific joint width advisable. Installing the tiles with a 6 mm joint ensures maximum safety.

## Safety without compromises

Accident prevention has the highest priority in every swimming pool – especially in areas with a particularly high risk of slipping, such as stairs leading into the water or walk-through pools. That is why Chroma also offers the slip-resistance classes of category "C". In this way, the highest design and safety requirements can be implemented uniformly and without compromise.

Oasia Hotel, Singapore / Architect: WOHA Architects + Patricia Urquiola  
Series: Chroma non-slip, Chroma / Photo: Infinitude

COLOR SYSTEM UNICOLOR – A color sphere becomes a sphere of possibilities



Contrasting colors (glossy)

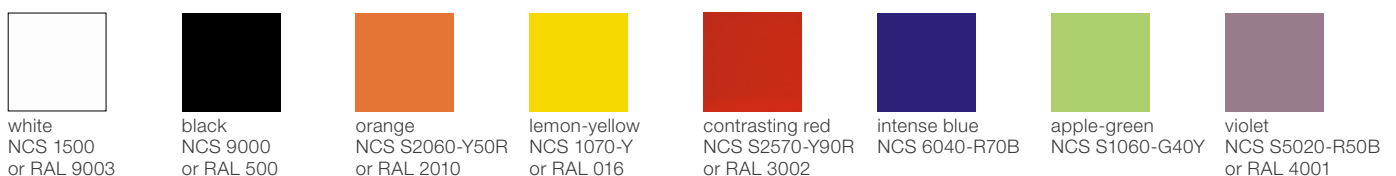

active ochre NCS S 3050-Y40R	active salmon NCS S 4040-Y70R	active oxid red NCS S 4050-Y90R	active stone grey NCS S 5030-Y90R	active sand-grey NCS S 7010-Y90R
light ochre NCS S 2030-Y20R	light salmon NCS S 1515-Y50R	light oxid red NCS S 2010-Y80R	light stone grey NCS S 2502-R	light sand-grey NCS S 1502-Y
medium ochre NCS S 3030-Y30R	medium salmon NCS S 2020-Y50R	medium oxid red NCS S 3020-Y80R	medium stone grey NCS S 3502-R or RAL 7036	medium sand-grey NCS S 3005-Y50R
dark ochre NCS S 4030-Y50R	dark salmon NCS S 3040-Y60R	dark oxid red NCS S 5020-Y80R	dark stone grey NCS S 6005-Y80R	dark sand-grey NCS S 6010-Y50R
<b>ochre</b>	<b>salmon</b>	<b>oxid red</b>	<b>stone grey</b>	<b>sand-grey</b>
neutral 3 (asphalt black) NCS S 6500-N	neutral 2 (anthracite) NCS S 7500-N or RAL 7015	neutral 1 (deep black) NCS S 9000-N or RAL 9017		

### Contrasting colors (glossy)

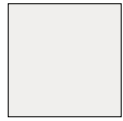

701  
neutral 10 (active white)

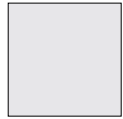

552119  
neutral 9 (white-grey)



552118  
neutral 8 (light-grey)



552117  
neutral 7 (pebble-grey)



552115  
neutral 5 (basalt-grey)



552113  
neutral 3 (asphalt black)



552112  
neutral 2 (anthracite)



5716  
neutral 1 (deep black)



552004  
dark azure



552008  
dark blue



552012  
dark turquoise



552016  
dark green



552020  
dark yellow



552024  
dark ochre



552028  
dark salmon



552032  
dark oxid red



552036  
dark stone grey



552040  
dark sand-grey



552003  
medium azure



552007  
medium blue



552011  
medium turquoise



552015  
medium green



552019  
medium yellow



552023  
medium ochre



552027  
medium salmon



552031  
medium oxid red



552035  
medium stone grey



552039  
medium sand-grey



552002  
light azure



552006  
light blue



552010  
light turquoise



552014  
light green



552018  
light yellow



552022  
light ochre



552026  
light salmon



552030  
light oxid red



552034  
light stone grey



552038  
light sand-grey



552001  
active azure



552005  
active blue



552009  
active turquoise



552013  
active green



552017  
active yellow



552021  
active ochre



552025  
active salmon



552029  
active oxid red



552033  
active stone grey



552037  
active sand-grey

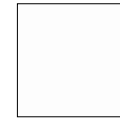

700  
white



151  
orange



154  
contrasting red



152  
apple-green



717  
black



150  
lemon-yellow



144  
intense blue



153  
violet





Floor/Wall tile  
6.2 x 25 cm, 2 1/2 x 10 in,  
smooth



Floor/Wall tile  
25 x 25 cm, 10 x 10 in,  
smooth



Floor/Wall tile  
12.5 x 12.5 cm, 5 x 5 in,  
smooth

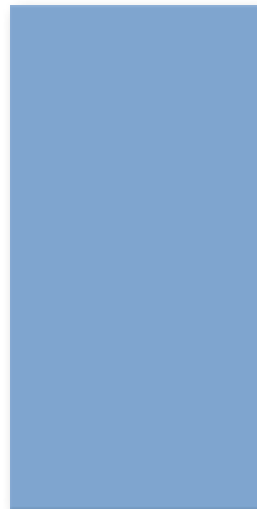

Floor/Wall tile  
25 x 50 cm, 10 x 20 in, smooth

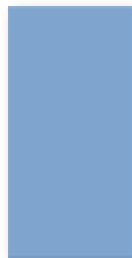

Floor/Wall tile  
12.5 x 25 cm, 5 x 10 in,  
smooth



Floor/Wall tile  
12.5 x 50 cm, 5 x 20 in,  
smooth



**Overglazed Edges/Corners<sup>1/2</sup>**  
**Floor/Wall Tiles**

6,2 x 25 cm



overglazed  
corner left

6,2 x 25 cm



overglazed  
corner right

12,5 x 12,5 cm



overglazed  
corner left

12,5 x 25 cm



overglazed  
corner left

12,5 x 25 cm



overglazed  
corner right

25 x 25 cm

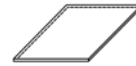

overglazed  
corner left



	18213H	18214H	12023H	18123H	18124H	12053H	Stress group	Model number
	6.2 x 25 / 2 1/2 x 10	6.2 x 25 / 2 1/2 x 10	12.5 x 12.5 / 5 x 5	12.5 x 25 / 5 x 10	12.5 x 25 / 5 x 10	25 x 25 / 10 x 10		
	56 x 244 x 6 mm	56 x 244 x 6 mm	119 x 119 x 6 mm	119 x 244 x 6 mm	119 x 244 x 6 mm	244 x 244 x 6 mm		Work size
	smooth, silky-matt <sup>4</sup>	smooth, silky-matt <sup>4</sup>	smooth, silky-matt <sup>4</sup>	smooth, silky-matt <sup>4</sup>	smooth, silky-matt <sup>4</sup>	smooth, silky-matt <sup>4</sup>		Surface
	64.000	64.000	64.000	32.000	32.000	16.000		m <sup>2</sup> - pieces
	10.880	10.880	12.160	12.160	12.160	12.800		m <sup>2</sup> - kg
	88	88	88	44	44	18		Bundle - pieces
	1.375	1.375	1.375	1.375	1.375	1.125		Bundle - m <sup>2</sup>
	14.960	14.960	16.720	16.720	16.720	14.400		Bundle - kg
	132.000	132.000	115.500	115.500	115.500	91.125		Pallet - m <sup>2</sup>
	1,436.160	1,436.160	1,404.480	1,404.480	1,404.480	1,166.400		Pallet - kg
	Alb	Alb	Alb	Alb	Alb	Alb		Product standard
	700i-18213H	700i-18214H	700i-12023H	700i-18123H	700i-18124H	700i-12053H	4	neutral 10 (active white glossy) <input type="checkbox"/> VO
	Price gr. A157 (m <sup>2</sup> )	Price gr. A157 (m <sup>2</sup> )	Price gr. A157 (m <sup>2</sup> )	Price gr. A109 (m <sup>2</sup> )	Price gr. A109 (m <sup>2</sup> )	Price gr. A157 (m <sup>2</sup> )		
	701i-18213H	701i-18214H	701i-12023H	701i-18123H	701i-18124H	701i-12053H	4	neutral 10 (active white matt) <input type="checkbox"/> VO
	Price gr. A157 (m <sup>2</sup> )	Price gr. A157 (m <sup>2</sup> )	Price gr. A157 (m <sup>2</sup> )	Price gr. A109 (m <sup>2</sup> )	Price gr. A109 (m <sup>2</sup> )	Price gr. A157 (m <sup>2</sup> )		
	5716i-18213H <sup>3</sup>	5716i-18214H <sup>3</sup>	5716i-12023H <sup>3</sup>	5716i-18123H <sup>3</sup>	5716i-18124H <sup>3</sup>	5716i-12053H <sup>3</sup>	1	neutral 1 (deep black) <input type="checkbox"/> VO
	Price gr. A187 (m <sup>2</sup> )	Price gr. A187 (m <sup>2</sup> )	Price gr. A187 (m <sup>2</sup> )	Price gr. A136 (m <sup>2</sup> )	Price gr. A136 (m <sup>2</sup> )	Price gr. A187 (m <sup>2</sup> )		
	552001-18213H	552001-18214H	552001-12023H	552001-18123H	552001-18124H	552001-12053H	2	active azure <input type="checkbox"/> VO
	Price gr. A187 (m <sup>2</sup> )	Price gr. A187 (pce.)	Price gr. A187 (m <sup>2</sup> )	Price gr. A136 (m <sup>2</sup> )	Price gr. A136 (m <sup>2</sup> )	Price gr. A187 (m <sup>2</sup> )		
	552002-18213H	552002-18214H	552002-12023H	552002-18123H	552002-18124H	552002-12053H	4	light azure <input type="checkbox"/> VO
	Price gr. A187 (m <sup>2</sup> )	Price gr. A187 (m <sup>2</sup> )	Price gr. A187 (m <sup>2</sup> )	Price gr. A136 (m <sup>2</sup> )	Price gr. A136 (m <sup>2</sup> )	Price gr. A187 (m <sup>2</sup> )		



<sup>3</sup> Production-related color deviations from the standard are possible.  
<sup>4</sup> Exception neutral 10 (active white glossy): smooth, glossy



Overglazed edges available on request:			overglazed edges	Example: Standard model no. 18120 = 119 x 244 x 6 mm, model no. 18123 = overglazed corner left
	... 3 = corner left	... 4 = corner right		







Solebad, Werne, Germany / Architect: Geising + Böker GmbH, Büro Vechta  
Photo: Jochen Stüber





### Slip resistance "B"

-/B



91 white / neutral 10 (active white)



553119 neutral 9 (white-grey)



553118 neutral 8 (light-grey)



553117 neutral 7 (pebble-grey)



553115 neutral 5 (basalt-grey)



553113 neutral 3 (asphalt black)



553112 neutral 2 (anthracite)



340 black / neutral 1 (deep black)

-/B



553004 dark azure



553008 dark blue



553016 dark green



553036 dark stone grey



553040 dark sand-grey



553003 medium azure



553007 medium blue



553011 medium turquoise



553015 medium green



553019 medium yellow



553023 medium ochre



553027 medium salmon



553031 medium oxid red



553035 medium stone grey



553039 medium sand-grey



553002 light azure



553006 light blue



553010 light turquoise

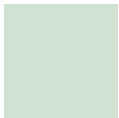

553014 light green



553018 light yellow



553026 light salmon



553034 light stone grey



553038 light sand-grey

-/B



553001 active azure



553033 active stone grey



553037 active sand-grey

-/B



77 contrasting red



Floor tile  
12.5 x 12.5 cm, 5 x 5 in,  
smooth, -/B



Floor tile  
12.5 x 25 cm, 5 x 10 in,  
smooth, -/B



Floor tile  
25 x 25 cm, 10 x 10 in,  
smooth, -/B

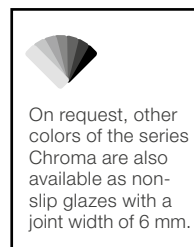



Slip resistance „B“

Floor Tiles<sup>2</sup>

12,5 x 12,5 cm<sup>3</sup>



12,5 x 25 cm



25 x 25 cm



	32020H	38110H	32050H	Model number
	12.5 x 12.5 / 5 x 5	12.5 x 25 / 5 x 10	25 x 25 / 10 x 10	Nom. dim. - cm/in
	119 x 119 x 8 mm	119 x 244 x 8 mm	244 x 244 x 8 mm	Work size
	smooth, silky-matt	smooth, silky-matt	smooth, silky-matt	Surface
	64.000	32.000	16.000	m <sup>2</sup> - pieces
	15.360	15.680	16.960	m <sup>2</sup> - kg
	66	33	14	Bundle - pieces
	1.031	1.031	0.875	Bundle - m <sup>2</sup>
	15.840	16.170	14.840	Bundle - kg
	86.625	86.625	70.875	Pallet - m <sup>2</sup>
	1,330.560	1,358.280	1,202.040	Pallet - kg
	Alb	Alb	Alb	Product standard
	-/B	-/B	-/B	Slip resistance
	2	2	2	Stress group
	<b>91i-32020H</b>	<b>91i-38110H</b>	<b>91i-32050H</b>	neutral 10
	Price gr. A217 (m <sup>2</sup> )	Price gr. A199 (m <sup>2</sup> )	Price gr. A217 (m <sup>2</sup> )	(active white) <input type="checkbox"/>
	<b>340i-32020H</b>	<b>340i-38110H</b>	<b>340i-32050H</b>	neutral 1
	Price gr. A217 (m <sup>2</sup> )	Price gr. A199 (m <sup>2</sup> )	Price gr. A217 (m <sup>2</sup> )	(deep black) <input type="checkbox"/>
	<b>553001-32020H</b>	<b>553001-38110H</b>	<b>553001-32050H</b>	active azure <input type="checkbox"/>
	Price gr. A217 (m <sup>2</sup> )	Price gr. A199 (m <sup>2</sup> )	Price gr. A217 (m <sup>2</sup> )	
	<b>553002-32020H</b>	<b>553002-38110H</b>	<b>553002-32050H</b>	light azure <input type="checkbox"/>
	Price gr. A217 (m <sup>2</sup> )	Price gr. A199 (m <sup>2</sup> )	Price gr. A217 (m <sup>2</sup> )	
	<b>553003-32020H</b>	<b>553003-38110H</b>	<b>553003-32050H</b>	medium azure <input type="checkbox"/>
	Price gr. A217 (m <sup>2</sup> )	Price gr. A199 (m <sup>2</sup> )	Price gr. A217 (m <sup>2</sup> )	
	<b>553004-32020H</b>	<b>553004-38110H</b>	<b>553004-32050H</b>	dark azure <input type="checkbox"/>
	Price gr. A217 (m <sup>2</sup> )	Price gr. A199 (m <sup>2</sup> )	Price gr. A217 (m <sup>2</sup> )	
	<b>553006-32020H</b>	<b>553006-38110H</b>	<b>553006-32050H</b>	light blue <input type="checkbox"/>
	Price gr. A217 (m <sup>2</sup> )	Price gr. A199 (m <sup>2</sup> )	Price gr. A217 (m <sup>2</sup> )	
	<b>553007-32020H</b>	<b>553007-38110H</b>	<b>553007-32050H</b>	medium blue <input type="checkbox"/>
	Price gr. A217 (m <sup>2</sup> )	Price gr. A199 (m <sup>2</sup> )	Price gr. A217 (m <sup>2</sup> )	
	<b>553008-32020H</b>	<b>553008-38110H<sup>1</sup></b>	<b>553008-32050H<sup>1</sup></b>	dark blue <input type="checkbox"/>
	Price gr. A217 (m <sup>2</sup> )	Price gr. A199 (m <sup>2</sup> )	Price gr. A217 (m <sup>2</sup> )	
	<b>553010-32020H</b>	<b>553010-38110H</b>	<b>553010-32050H<sup>1</sup></b>	light turquoise <input type="checkbox"/>
	Price gr. A217 (m <sup>2</sup> )	Price gr. A199 (m <sup>2</sup> )	Price gr. A217 (m <sup>2</sup> )	
	<b>553011-32020H</b>	<b>553011-38110H</b>	<b>553011-32050H</b>	medium turquoise <input type="checkbox"/>
	Price gr. A217 (m <sup>2</sup> )	Price gr. A199 (m <sup>2</sup> )	Price gr. A217 (m <sup>2</sup> )	
	<b>553014-32020H</b>	<b>553014-38110H<sup>1</sup></b>	<b>553014-32050H<sup>1</sup></b>	light green <input type="checkbox"/>
	Price gr. A217 (m <sup>2</sup> )	Price gr. A199 (m <sup>2</sup> )	Price gr. A217 (m <sup>2</sup> )	
	<b>553015-32020H</b>	<b>553015-38110H</b>	<b>553015-32050H</b>	medium green <input type="checkbox"/>
	Price gr. A217 (m <sup>2</sup> )	Price gr. A199 (m <sup>2</sup> )	Price gr. A217 (m <sup>2</sup> )	
	<b>553016-32020H</b>	<b>553016-38110H</b>	<b>553016-32050H</b>	dark green <input type="checkbox"/>
	Price gr. A217 (m <sup>2</sup> )	Price gr. A199 (m <sup>2</sup> )	Price gr. A217 (m <sup>2</sup> )	
	<b>553018-32020H<sup>1</sup></b>	<b>553018-38110H<sup>1</sup></b>	<b>553018-32050H<sup>1</sup></b>	light yellow <input type="checkbox"/>
	Price gr. A217 (m <sup>2</sup> )	Price gr. A199 (m <sup>2</sup> )	Price gr. A217 (m <sup>2</sup> )	
	<b>553019-32020H</b>	<b>553019-38110H</b>	<b>553019-32050H</b>	medium yellow <input type="checkbox"/>
	Price gr. A217 (m <sup>2</sup> )	Price gr. A199 (m <sup>2</sup> )	Price gr. A217 (m <sup>2</sup> )	
	<b>553023-32020H<sup>1</sup></b>	<b>553023-38110H</b>	<b>553023-32050H</b>	medium ochre <input type="checkbox"/>
	Price gr. A217 (m <sup>2</sup> )	Price gr. A199 (m <sup>2</sup> )	Price gr. A217 (m <sup>2</sup> )	
	<b>553026-32020H<sup>1</sup></b>	<b>553026-38110H<sup>1</sup></b>	<b>553026-32050H<sup>1</sup></b>	light salmon <input type="checkbox"/>
	Price gr. A217 (m <sup>2</sup> )	Price gr. A199 (m <sup>2</sup> )	Price gr. A217 (m <sup>2</sup> )	
	<b>553027-32020H<sup>1</sup></b>	<b>553027-38110H</b>	<b>553027-32050H</b>	medium salmon <input type="checkbox"/>
	Price gr. A217 (m <sup>2</sup> )	Price gr. A199 (m <sup>2</sup> )	Price gr. A217 (m <sup>2</sup> )	
	<b>553031-32020H</b>	<b>553031-38110H<sup>1</sup></b>	<b>553031-32050H<sup>1</sup></b>	medium oxide red <input type="checkbox"/>
	Price gr. A217 (m <sup>2</sup> )	Price gr. A199 (m <sup>2</sup> )	Price gr. A217 (m <sup>2</sup> )	
	<b>553033-32020H<sup>1</sup></b>	<b>553033-38110H<sup>1</sup></b>	<b>553033-32050H<sup>1</sup></b>	active stone grey <input type="checkbox"/>
	Price gr. A217 (m <sup>2</sup> )	Price gr. A199 (m <sup>2</sup> )	Price gr. A217 (m <sup>2</sup> )	
	<b>553034-32020H</b>	<b>553034-38110H<sup>1</sup></b>	<b>553034-32050H<sup>1</sup></b>	light stone grey <input type="checkbox"/>
	Price gr. A217 (m <sup>2</sup> )	Price gr. A199 (m <sup>2</sup> )	Price gr. A217 (m <sup>2</sup> )	
	<b>553035-32020H</b>	<b>553035-38110H</b>	<b>553035-32050H<sup>1</sup></b>	medium stone grey <input type="checkbox"/>
	Price gr. A217 (m <sup>2</sup> )	Price gr. A199 (m <sup>2</sup> )	Price gr. A217 (m <sup>2</sup> )	
	<b>553036-32020H</b>	<b>553036-38110H</b>	<b>553036-32050H<sup>1</sup></b>	dark stone grey <input type="checkbox"/>
	Price gr. A217 (m <sup>2</sup> )	Price gr. A199 (m <sup>2</sup> )	Price gr. A217 (m <sup>2</sup> )	



<sup>2</sup> Rounded edges / corners refer to page 155

<sup>3</sup> Supplied as double-tiles; to be broken by customer.

Slip resistance „B“

Floor Tiles<sup>2</sup>

12,5 x 12,5 cm<sup>3</sup>



12,5 x 25 cm



25 x 25 cm



Model number	32020H	38110H	32050H			
Nom. dim. - cm/in	12.5 x 12.5 / 5 x 5	12.5 x 25 / 5 x 10	25 x 25 / 10 x 10			
Work size	119 x 119 x 8 mm	119 x 244 x 8 mm	244 x 244 x 8 mm			
Surface	smooth, silky-matt	smooth, silky-matt	smooth, silky-matt			
m <sup>2</sup> - pieces	64.000	32.000	16.000			
m <sup>2</sup> - kg	15.360	15.680	16.960			
Bundle - pieces	66	33	14			
Bundle - m <sup>2</sup>	1.031	1.031	0.875			
Bundle - kg	15.840	16.170	14.840			
Pallet - m <sup>2</sup>	86.625	86.625	70.875			
Pallet - kg	1,330.500	1,358.280	1,202.040			
Product standard	Alb	Alb	Alb			
Slip resistance	-/B	-/B	-/B			
Stress group	2	2	2			
active sand-grey	553037-32020H <sup>1</sup> Price gr. A217 (m <sup>2</sup> )	553037-38110H <sup>1</sup> Price gr. A199 (m <sup>2</sup> )	553037-32050H <sup>1</sup> Price gr. A217 (m <sup>2</sup> )			
light sand-grey	553038-32020H Price gr. A217 (m <sup>2</sup> )	553038-38110H Price gr. A199 (m <sup>2</sup> )	553038-32050H <sup>1</sup> Price gr. A217 (m <sup>2</sup> )			
medium sand-grey	553039-32020H Price gr. A217 (m <sup>2</sup> )	553039-38110H <sup>1</sup> Price gr. A199 (m <sup>2</sup> )	553039-32050H <sup>1</sup> Price gr. A217 (m <sup>2</sup> )			
dark sand-grey	553040-32020H Price gr. A217 (m <sup>2</sup> )	553040-38110H <sup>1</sup> Price gr. A199 (m <sup>2</sup> )	553040-32050H <sup>1</sup> Price gr. A217 (m <sup>2</sup> )			
neutral 9 (white grey)	553119-32020H <sup>1</sup> Price gr. A217 (m <sup>2</sup> )	553119-38110H <sup>1</sup> Price gr. A199 (m <sup>2</sup> )	553119-32050H Price gr. A217 (m <sup>2</sup> )			
neutral 8 (light-grey)	553118-32020H Price gr. A217 (m <sup>2</sup> )	553118-38110H <sup>1</sup> Price gr. A199 (m <sup>2</sup> )	553118-32050H Price gr. A217 (m <sup>2</sup> )			
neutral 7 (pebble-grey)	553117-32020H Price gr. A217 (m <sup>2</sup> )	553117-38110H Price gr. A199 (m <sup>2</sup> )	553117-32050H Price gr. A217 (m <sup>2</sup> )			
neutral 5 (basalt grey)	553115-32020H <sup>1</sup> Price gr. A217 (m <sup>2</sup> )	553115-38110H <sup>1</sup> Price gr. A199 (m <sup>2</sup> )	553115-32050H <sup>1</sup> Price gr. A217 (m <sup>2</sup> )			
neutral 3 (asphalt black)	553113-32020H Price gr. A217 (m <sup>2</sup> )	553113-38110H Price gr. A199 (m <sup>2</sup> )	553113-32050H Price gr. A217 (m <sup>2</sup> )			
neutral 2 (anthracite)	553112-32020H Price gr. A217 (m <sup>2</sup> )	553112-38110H Price gr. A199 (m <sup>2</sup> )	553112-32050H Price gr. A217 (m <sup>2</sup> )			
contrasting red	77i-32020H Price gr. A217 (m <sup>2</sup> )	77i-38110H Price gr. A199 (m <sup>2</sup> )	77i-32050H Price gr. A217 (m <sup>2</sup> )			



<sup>2</sup> Rounded edges / corners refer to page 155

<sup>3</sup> Supplied as double-tiles; to be broken by customer.

Slip resistance „B“ – rounded edges/corners<sup>1/2</sup>

Floor Tiles



	<i>rounded edge</i>	<i>rounded corner</i>	<i>short side rounded</i>	<i>long side rounded</i>	<i>rounded corner left</i>	<i>rounded corner right</i>	
	32025H	32027H	38115H	38116H	38117H	38118H	Model number
	12.5 x 12.5 / 5 x 5	12.5 x 12.5 / 5 x 5	12.5 x 25 / 5 x 10	12.5 x 25 / 5 x 10	12.5 x 25 / 5 x 10	12.5 x 25 / 5 x 10	Nom. dim. - cm/in
	119 x 119 x 8 mm	119 x 119 x 8 mm	119 x 244 x 8 mm	119 x 244 x 8 mm	119 x 244 x 8 mm	119 x 244 x 8 mm	Work size
	smooth, silky-matt	smooth, silky-matt	smooth, silky-matt	smooth, silky-matt	smooth, silky-matt	smooth, silky-matt	Surface
	0.240	0.240	0.490	0.490	0.490	0.490	m <sup>2</sup> - pieces
	66	66	33	33	33	33	m <sup>2</sup> - kg
	15.840	15.840	16.170	16.170	16.170	16.170	Bundle - pieces
	Alb	Alb	Alb	Alb	Alb	Alb	Bundle - m <sup>2</sup>
	-/B	-/B	-/B	-/B	-/B	-/B	Bundle - kg
	2	2	2	2	2	2	Pallet - m <sup>2</sup>
	91i-32025H	91i-32027H	91i-38115H	91i-38116H	91i-38117H	91i-38118H	Pallet - kg
	Price gr. A410 (pce.)	Price gr. A410 (pce.)	Price gr. A416 (pce.)	Price gr. A416 (pce.)	Price gr. A416 (pce.)	Price gr. A416 (pce.)	Product standard
	340i-32025H	340i-32027H	340i-38115H	340i-38116H	340i-38117H	340i-38118H	Slip resistance
	Price gr. A410 (pce.)	Price gr. A410 (pce.)	Price gr. A416 (pce.)	Price gr. A416 (pce.)	Price gr. A416 (pce.)	Price gr. A416 (pce.)	Stress group
	553001-32025H	553001-32027H	553001-38115H	553001-38116H	553001-38117H	553001-38118H	neutral 10
	Price gr. A410 (pce.)	Price gr. A410 (pce.)	Price gr. A416 (pce.)	Price gr. A416 (pce.)	Price gr. A416 (pce.)	Price gr. A416 (pce.)	(active white) <input type="checkbox"/>
	553002-32025H	553002-32027H	553002-38115H	553002-38116H	553002-38117H	553002-38118H	neutral 1
	Price gr. A410 (pce.)	Price gr. A410 (pce.)	Price gr. A416 (pce.)	Price gr. A416 (pce.)	Price gr. A416 (pce.)	Price gr. A416 (pce.)	(deep black) <input type="checkbox"/>
							active azure <input type="checkbox"/>
							light azure <input type="checkbox"/>



Floor Tiles



	<i>rounded edge</i>	<i>rounded corner</i>	
	32055H	32057H	Model number
	25 x 25 / 10 x 10	25 x 25 / 10 x 10	Nom. dim. - cm/in
	244 x 244 x 8 mm	244 x 244 x 8 mm	Work size
	smooth, silky-matt	smooth, silky-matt	Surface
	1.060	1.060	m <sup>2</sup> - pieces
	14	14	m <sup>2</sup> - kg
	14.840	14.840	Bundle - pieces
	Alb	Alb	Bundle - m <sup>2</sup>
	-/B	-/B	Bundle - kg
	2	2	Pallet - m <sup>2</sup>
	91i-32055H	91i-32057H	Pallet - kg
	Price gr. A434 (pce.)	Price gr. A434 (pce.)	Product standard
	340i-32055H	340i-32057H	Slip resistance
	Price gr. A434 (pce.)	Price gr. A434 (pce.)	Stress group
	553001-32055H	553001-32057H	neutral 10
	Price gr. A434 (pce.)	Price gr. A434 (pce.)	(active white) <input type="checkbox"/>
	553002-32055H	553002-32057H	neutral 1
	Price gr. A434 (pce.)	Price gr. A434 (pce.)	(deep black) <input type="checkbox"/>
			active azure <input type="checkbox"/>
			light azure <input type="checkbox"/>

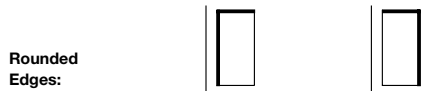

Rounded Edges:

Replace last figure 0 of Standard model no. by ...	... 7 = corner left	... 8 = corner right	overglazed edges	Example: Standard model no. 38110 = 119 x 244 x 6 mm, model no. 38117 = rounded corner left
--	---------------------	----------------------	------------------	---

Slip resistance "C"

-/C



81 white / neutral 10 (active white)



554119 neutral 9 (white-grey)



554118 neutral 8 (light-grey)



554117 neutral 7 (pebble-grey)



554113 neutral 3 (asphalt black)



554111 black / neutral 1 (deep black)

-/C



554004 dark azure



554008 dark blue



554016 dark green



554036 dark stone grey



554040 dark sand-grey



554003 medium azure



554007 medium blue



554011 medium turquoise



554015 medium green



554019 medium yellow



554023 medium ochre



554027 medium salmon



554031 medium oxid red



554035 medium stone grey



554039 medium sand-grey



554002 light azure

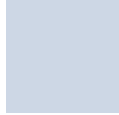

554006 light blue



554010 light turquoise



554014 light green



554026 light salmon



554038 light sand-grey

-/C



554001 active azure

-/C



78 contrasting red



Floor tile  
12.5 x 12.5 cm, 5 x 5 in,  
structured, -/C



Floor tile  
12.5 x 25 cm, 5 x 10 in,  
structured, -/C

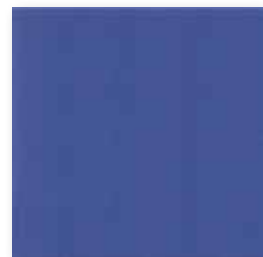

Floor tile  
25 x 25 cm, 10 x 10 in,  
structured, -/C

 On request, other colors of the series Chroma are also available as non-slip glazes with a joint width of 6 mm.

Slip resistance „C“  
Floor Tiles<sup>2</sup>

12,5 x 12,5 cm<sup>3</sup>



12,5 x 25 cm



25 x 25 cm



				32020H	38110H	32050H	Model number
				<b>12.5 x 12.5 / 5 x 5</b>	<b>12.5 x 25 / 5 x 10</b>	<b>25 x 25 / 10 x 10</b>	Nom. dim. - cm/in
				119 x 119 x 8 mm	119 x 244 x 8 mm	244 x 244 x 8 mm	Work size
				structured, silky-matt	structured, silky-matt	structured, silky-matt	Surface
				64.000	32.000	16.000	m <sup>2</sup> - pieces
				15.360	15.680	16.960	m <sup>2</sup> - kg
				66	33	14	Bundle - pieces
				1.031	1.031	0.875	Bundle - m <sup>2</sup>
				15.840	16.170	14.840	Bundle - kg
				86.625	86.625	70.875	Pallet - m <sup>2</sup>
				1,330.560	1,358.280	1,202.040	Pallet - kg
				Alb	Alb	Alb	Product standard
				-/C	-/C	-/C	Slip resistance
				2	2	2	Stress group
				<b>81i-32020H</b>	<b>81i-38110H</b>	<b>81i-32050H</b>	neutral 10
				Price gr. A217 (m <sup>2</sup> )	Price gr. A199 (m <sup>2</sup> )	Price gr. A217 (m <sup>2</sup> )	(active white) <input type="checkbox"/>
				<b>554111-32020H</b>	<b>554111-38110H</b>	<b>554111-32050H<sup>1</sup></b>	neutral 1
				Price gr. A217 (m <sup>2</sup> )	Price gr. A199 (m <sup>2</sup> )	Price gr. A217 (m <sup>2</sup> )	(deep black) <input type="checkbox"/>
				<b>554001-32020H</b>	<b>554001-38110H</b>	<b>554001-32050H<sup>1</sup></b>	active azure <input type="checkbox"/>
				Price gr. A217 (m <sup>2</sup> )	Price gr. A199 (m <sup>2</sup> )	Price gr. A217 (m <sup>2</sup> )	
				<b>554002-32020H</b>	<b>554002-38110H</b>	<b>554002-32050H</b>	light azure <input type="checkbox"/>
				Price gr. A217 (m <sup>2</sup> )	Price gr. A199 (m <sup>2</sup> )	Price gr. A217 (m <sup>2</sup> )	
				<b>554003-32020H</b>	<b>554003-38110H</b>	<b>554003-32050H</b>	medium azure <input type="checkbox"/>
				Price gr. A217 (m <sup>2</sup> )	Price gr. A199 (m <sup>2</sup> )	Price gr. A217 (m <sup>2</sup> )	
				<b>554004-32020H</b>	<b>554004-38110H</b>	<b>554004-32050H<sup>1</sup></b>	dark azure <input type="checkbox"/>
				Price gr. A217 (m <sup>2</sup> )	Price gr. A199 (m <sup>2</sup> )	Price gr. A217 (m <sup>2</sup> )	
				<b>554006-32020H</b>	<b>554006-38110H</b>	<b>554006-32050H<sup>1</sup></b>	light blue <input type="checkbox"/>
				Price gr. A217 (m <sup>2</sup> )	Price gr. A199 (m <sup>2</sup> )	Price gr. A217 (m <sup>2</sup> )	
				<b>554007-32020H</b>	<b>554007-38110H</b>	<b>554007-32050H<sup>1</sup></b>	medium blue <input type="checkbox"/>
				Price gr. A217 (m <sup>2</sup> )	Price gr. A199 (m <sup>2</sup> )	Price gr. A217 (m <sup>2</sup> )	
				<b>554008-32020H</b>	<b>554008-38110H</b>	<b>554008-32050H<sup>1</sup></b>	dark blue <input type="checkbox"/>
				Price gr. A217 (m <sup>2</sup> )	Price gr. A199 (m <sup>2</sup> )	Price gr. A217 (m <sup>2</sup> )	
				<b>554010-32020H</b>	<b>554010-38110H</b>	<b>554010-32050H<sup>1</sup></b>	light turquoise <input type="checkbox"/>
				Price gr. A217 (m <sup>2</sup> )	Price gr. A199 (m <sup>2</sup> )	Price gr. A217 (m <sup>2</sup> )	
				<b>554011-32020H</b>	<b>554011-38110H</b>	<b>554011-32050H<sup>1</sup></b>	medium turquoise <input type="checkbox"/>
				Price gr. A217 (m <sup>2</sup> )	Price gr. A199 (m <sup>2</sup> )	Price gr. A217 (m <sup>2</sup> )	
				<b>554014-32020H</b>	<b>554014-38110H<sup>1</sup></b>	<b>554014-32050H<sup>1</sup></b>	light green <input type="checkbox"/>
				Price gr. A217 (m <sup>2</sup> )	Price gr. A199 (m <sup>2</sup> )	Price gr. A217 (m <sup>2</sup> )	
				<b>554015-32020H</b>	<b>554015-38110H<sup>1</sup></b>	<b>554015-32050H<sup>1</sup></b>	medium green <input type="checkbox"/>
				Price gr. A217 (m <sup>2</sup> )	Price gr. A199 (m <sup>2</sup> )	Price gr. A217 (m <sup>2</sup> )	
				<b>554016-32020H</b>	<b>554016-38110H</b>	<b>554016-32050H</b>	dark green <input type="checkbox"/>
				Price gr. A217 (m <sup>2</sup> )	Price gr. A199 (m <sup>2</sup> )	Price gr. A217 (m <sup>2</sup> )	
				<b>554019-32020H</b>	<b>554019-38110H</b>	<b>554019-32050H<sup>1</sup></b>	medium yellow <input type="checkbox"/>
				Price gr. A217 (m <sup>2</sup> )	Price gr. A199 (m <sup>2</sup> )	Price gr. A217 (m <sup>2</sup> )	
				<b>554023-32020H</b>	<b>554023-38110H</b>	<b>554023-32050H</b>	medium ochre <input type="checkbox"/>
				Price gr. A217 (m <sup>2</sup> )	Price gr. A199 (m <sup>2</sup> )	Price gr. A217 (m <sup>2</sup> )	
				<b>554026-32020H<sup>1</sup></b>	<b>554026-38110H<sup>1</sup></b>	<b>554026-32050H<sup>1</sup></b>	light salmon <input type="checkbox"/>
				Price gr. A217 (m <sup>2</sup> )	Price gr. A199 (m <sup>2</sup> )	Price gr. A217 (m <sup>2</sup> )	
				<b>554027-32020H</b>	<b>554027-38110H</b>	<b>554027-32050H<sup>1</sup></b>	medium salmon <input type="checkbox"/>
				Price gr. A217 (m <sup>2</sup> )	Price gr. A199 (m <sup>2</sup> )	Price gr. A217 (m <sup>2</sup> )	
				<b>554031-32020H</b>	<b>554031-38110H</b>	<b>554031-32050H<sup>1</sup></b>	medium oxide red <input type="checkbox"/>
				Price gr. A217 (m <sup>2</sup> )	Price gr. A199 (m <sup>2</sup> )	Price gr. A217 (m <sup>2</sup> )	
				<b>554035-32020H</b>	<b>554035-38110H</b>	<b>554035-32050H<sup>1</sup></b>	medium stone grey <input type="checkbox"/>
				Price gr. A217 (m <sup>2</sup> )	Price gr. A199 (m <sup>2</sup> )	Price gr. A217 (m <sup>2</sup> )	
				<b>554036-32020H</b>	<b>554036-38110H</b>	<b>554036-32050H<sup>1</sup></b>	dark stone grey <input type="checkbox"/>
				Price gr. A217 (m <sup>2</sup> )	Price gr. A199 (m <sup>2</sup> )	Price gr. A217 (m <sup>2</sup> )	
				<b>554038-32020H</b>	<b>554038-38110H</b>	<b>554038-32050H</b>	light sand-grey <input type="checkbox"/>
				Price gr. A217 (m <sup>2</sup> )	Price gr. A199 (m <sup>2</sup> )	Price gr. A217 (m <sup>2</sup> )	
				<b>554039-32020H</b>	<b>554039-38110H</b>	<b>554039-32050H<sup>1</sup></b>	medium sand-grey <input type="checkbox"/>
				Price gr. A217 (m <sup>2</sup> )	Price gr. A199 (m <sup>2</sup> )	Price gr. A217 (m <sup>2</sup> )	
				<b>554040-32020H</b>	<b>554040-38110H</b>	<b>554040-32050H<sup>1</sup></b>	dark sand-grey <input type="checkbox"/>
				Price gr. A217 (m <sup>2</sup> )	Price gr. A199 (m <sup>2</sup> )	Price gr. A217 (m <sup>2</sup> )	
				<b>554119-32020H<sup>1</sup></b>	<b>554119-38110H</b>	<b>554119-32050H<sup>1</sup></b>	neutral 9
				Price gr. A217 (m <sup>2</sup> )	Price gr. A199 (m <sup>2</sup> )	Price gr. A217 (m <sup>2</sup> )	(white grey) <input type="checkbox"/>
				<b>554118-32020H</b>	<b>554118-38110H</b>	<b>554118-32050H<sup>1</sup></b>	neutral 8
				Price gr. A217 (m <sup>2</sup> )	Price gr. A199 (m <sup>2</sup> )	Price gr. A217 (m <sup>2</sup> )	(light-grey) <input type="checkbox"/>
				<b>554117-32020H</b>	<b>554117-38110H</b>	<b>554117-32050H</b>	neutral 7
				Price gr. A217 (m <sup>2</sup> )	Price gr. A199 (m <sup>2</sup> )	Price gr. A217 (m <sup>2</sup> )	(pebble-grey) <input type="checkbox"/>
				<b>554113-32020H</b>	<b>554113-38110H</b>	<b>554113-32050H</b>	neutral 3
				Price gr. A217 (m <sup>2</sup> )	Price gr. A199 (m <sup>2</sup> )	Price gr. A217 (m <sup>2</sup> )	(asphalt black) <input type="checkbox"/>
				<b>78i-32020H</b>	<b>78i-38110H</b>	<b>78i-32050H<sup>1</sup></b>	contrasting red <input type="checkbox"/>
				Price gr. A217 (m <sup>2</sup> )	Price gr. A199 (m <sup>2</sup> )	Price gr. A217 (m <sup>2</sup> )	



<sup>1</sup> Rounded edges / corners refer to page 158  
<sup>3</sup> Supplied as double-tiles; to be broken by customer.



Slip resistance „C“ – rounded edges/corners<sup>1/2</sup>

Floor Tiles



	<i>rounded edge</i>	<i>rounded corner</i>	<i>short side rounded</i>	<i>long side rounded</i>	<i>rounded corner left</i>	<i>rounded corner right</i>
Model number	32025H	32027H	38115H	38116H	38117H	38118H
Nom. dim. - cm/in	<b>12.5 x 12.5</b> / 5 x 5	<b>12.5 x 12.5</b> / 5 x 5	<b>12.5 x 25</b> / 5 x 10	<b>12.5 x 25</b> / 5 x 10	<b>12.5 x 25</b> / 5 x 10	<b>12.5 x 25</b> / 5 x 10
Work size	119 x 119 x 8 mm	119 x 119 x 8 mm	119 x 244 x 8 mm	119 x 244 x 8 mm	119 x 244 x 8 mm	119 x 244 x 8 mm
Surface	structured, silky-matt	structured, silky-matt	structured, silky-matt	structured, silky-matt	structured, silky-matt	structured, silky-matt
m <sup>2</sup> - pieces						
m <sup>2</sup> - kg	0.240	0.240	0.490	0.490	0.490	0.490
Bundle - pieces	66	66	33	33	33	33
Bundle - m <sup>2</sup>						
Bundle - kg	15.840	15.840	16.170	16.170	16.170	16.170
Pallet - m <sup>2</sup>						
Pallet - kg						
Product standard	Alb	Alb	Alb	Alb	Alb	Alb
Slip resistance	-/C	-/C	-/C	-/C	-/C	-/C
Stress group	2	2	2	2	2	2
neutral 10	81i-32025H	81i-32027H	81i-38115H	81i-38116H	81i-38117H	81i-38118H
(active white)	Price gr. A410 (pce.)	Price gr. A410 (pce.)	Price gr. A416 (pce.)	Price gr. A416 (pce.)	Price gr. A416 (pce.)	Price gr. A416 (pce.)
neutral 1	554111-32025H	554111-32027H	554111-38115H	554111-38116H	554111-38117H	554111-38118H
(deep black)	Price gr. A410 (pce.)	Price gr. A410 (pce.)	Price gr. A416 (pce.)	Price gr. A416 (pce.)	Price gr. A416 (pce.)	Price gr. A416 (pce.)
active azure	554001-32025H	554001-32027H	554001-38115H	554001-38116H	554001-38117H	554001-38118H
	Price gr. A410 (pce.)	Price gr. A410 (pce.)	Price gr. A416 (pce.)	Price gr. A416 (pce.)	Price gr. A416 (pce.)	Price gr. A416 (pce.)
light azure	554002-32025H	554002-32027H	554002-38115H	554002-38116H	554002-38117H	554002-38118H
	Price gr. A410 (pce.)	Price gr. A410 (pce.)	Price gr. A416 (pce.)	Price gr. A416 (pce.)	Price gr. A416 (pce.)	Price gr. A416 (pce.)



	<i>rounded edge</i>	<i>rounded corner</i>
Model number	32055H	32057H
Nom. dim. - cm/in	<b>25 x 25</b> / 10 x 10	<b>25 x 25</b> / 10 x 10
Work size	244 x 244 x 8 mm	244 x 244 x 8 mm
Surface	structured, silky-matt	structured, silky-matt
m <sup>2</sup> - pieces		
m <sup>2</sup> - kg	1.060	1.060
Bundle - pieces	14	14
Bundle - m <sup>2</sup>		
Bundle - kg	14.840	14.840
Pallet - m <sup>2</sup>		
Pallet - kg		
Product standard	Alb	Alb
Slip resistance	-/C	-/C
Stress group	2	2
neutral 10	81i-32055H	81i-32057H
(active white)	Price gr. A434 (pce.)	Price gr. A434 (pce.)
neutral 1	554111-32055H	554111-32057H
(deep black)	Price gr. A434 (pce.)	Price gr. A434 (pce.)
active azure	554001-32055H	554001-32057H
	Price gr. A434 (pce.)	Price gr. A434 (pce.)
light azure	554002-32055H	554002-32057H
	Price gr. A434 (pce.)	Price gr. A434 (pce.)



**Rounded Edges:**



Replace last figure 0 of Standard model no. by ...	... 7 = corner left	... 8 = corner right	overglazed edges	Example: Standard model no. 38110 = 119 x 244 x 6 mm, model no. 38117 = rounded corner left
--	---------------------	----------------------	------------------	---



Oasia Hotel, Singapore / Architect: WOHA Architects + Patricia Urquiola / Series: Chroma non-slip, Chroma / Photo: Infitude











R10/A R10/B R11/B



## Quantum



926  
white / neutral 10 (active white)



555118  
neutral 8 (light-grey)



555117  
neutral 7 (pebble-grey)



555113  
neutral 3 (asphalt black)



918  
black / neutral 1 (deep black)



901  
natural-white



555023  
medium ochre



555036  
dark stone grey



555035  
medium stone grey



555040  
dark sand-grey



555039  
medium sand-grey



555038  
light sand-grey



Floor/Wall tile  
12.5 x 12.5 cm, 5 x 5 in, smooth,  
R10/A

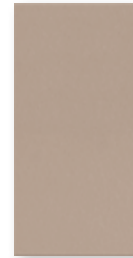

Floor/Wall tile  
12.5 x 25 cm, 5 x 10 in, smooth,  
R10/A

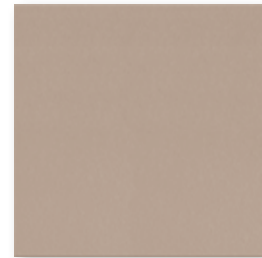

Floor/Wall tile  
25 x 25 cm, 10 x 10 in, smooth,  
R10/A

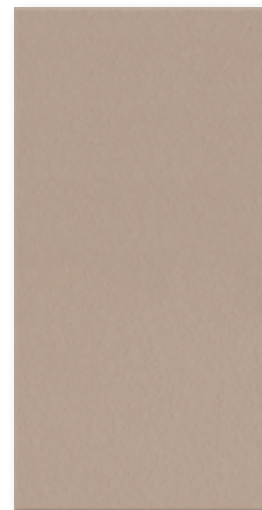

Floor/Wall tile  
25 x 50 cm, 10 x 20 in, smooth, R10/A

## Grid profile



Grid profile tile  
12.5 x 12.5 cm, 5 x 5 in, relief, R11/B



Grid profile tile  
12.5 x 25 cm, 5 x 10 in, relief, R11/B

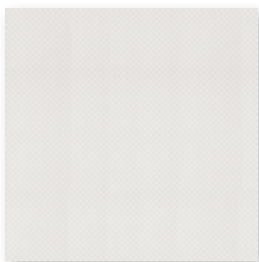

Grid profile tile  
25 x 25 cm, 10 x 10 in, relief, R11/B

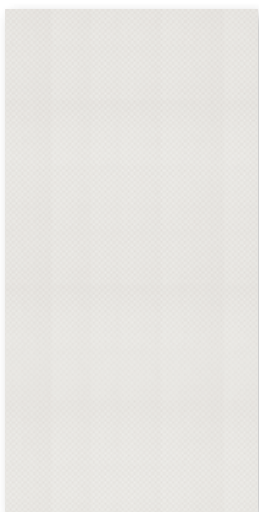

Grid profile tile  
25 x 50 cm, 10 x 20 in, relief, R11/B

## Shower Tub System

Shower tub system  
Corner (one piece)  
12.5 x 12.5 cm, 5 x 5 in, smooth, R10/B

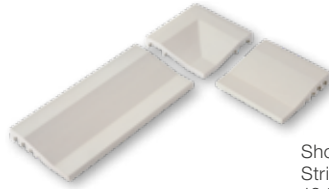

Shower tub system  
Strip  
12.5 x 12.5 cm, 5 x 5 in  
smooth, R10/B

Shower tub system  
Strip  
25 x 12.5 cm, 10 x 5 in  
smooth, R10/B

Cove skirting, r = 12 mm  
25 x 12.5 cm, 10 x 5 in, smooth



External angle,  
smooth

Internal angle,  
smooth

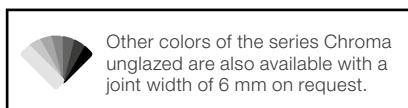

Other colors of the series Chroma unglazed are also available with a joint width of 6 mm on request.

Quantum

Floor/Wall Tiles

12,5 x 12,5 cm<sup>3</sup>



12,5 x 25 cm



25 x 25 cm



25 x 50 cm<sup>1/2/4</sup>

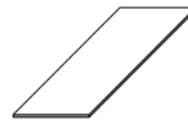

Model number	32020H	38110H	32050H	42550HK			
Nom. dim. - cm/in	12.5 x 12.5 / 5 x 5	12.5 x 25 / 5 x 10	25 x 25 / 10 x 10	25 x 50 / 10 x 20			
Work size	119 x 119 x 8 mm	119 x 244 x 8 mm	244 x 244 x 8 mm	244 x 494 x 8 mm			
Surface	smooth, silky-matt	smooth, silky-matt	smooth, silky-matt	smooth, silky-matt			
m <sup>2</sup> - pieces	64.000	32.000	16.000	8.000			
m <sup>2</sup> - kg	15.360	15.680	16.960	17.040			
Bundle - pieces	66	33	14	9			
Bundle - m <sup>2</sup>	1.031	1.031	0.875	1.125			
Bundle - kg	15.840	16.170	14.840	19.170			
Pallet - m <sup>2</sup>	86.625	86.625	70.875	40.500			
Pallet - kg	1,330.560	1,358.280	1,202.040	690.120			
Product standard	Alb	Alb	Alb	Alb			
Slip resistance	R10/A	R10/A	R10/A	R10/A			
Stress group	2	2	2	2			
neutral 10	<b>926i-32020H</b>	<b>926i-38110H</b>	<b>926i-32050H</b>	<b>926i-42550HK</b>			
(active white) <input type="checkbox"/>	Price gr. <b>A166</b> (m <sup>2</sup> )	Price gr. <b>A166</b> (m <sup>2</sup> )	Price gr. <b>A166</b> (m <sup>2</sup> )	Price gr. <b>A178</b> (m <sup>2</sup> )			
neutral 1	<b>918i-32020H</b>	<b>918i-38110H</b>	<b>918i-32050H</b>	<b>918i-42550HK</b>			
(deep black) <input type="checkbox"/>	Price gr. <b>A166</b> (m <sup>2</sup> )	Price gr. <b>A166</b> (m <sup>2</sup> )	Price gr. <b>A166</b> (m <sup>2</sup> )	Price gr. <b>A178</b> (m <sup>2</sup> )			
medium ochre <input type="checkbox"/>	<b>555023-32020H<sup>2/4</sup></b>	<b>555023-38110H<sup>2/4</sup></b>	<b>555023-32050H<sup>2/4</sup></b>	<b>555023-42550HK</b>			
	Price gr. <b>A166</b> (m <sup>2</sup> )	Price gr. <b>A166</b> (m <sup>2</sup> )	Price gr. <b>A166</b> (m <sup>2</sup> )	Price gr. <b>A178</b> (m <sup>2</sup> )			
medium stone grey <input type="checkbox"/>	<b>555035-32020H<sup>2/4</sup></b>	<b>555035-38110H<sup>2/4</sup></b>	<b>555035-32050H<sup>2/4</sup></b>	<b>555035-42550HK</b>			
	Price gr. <b>A166</b> (m <sup>2</sup> )	Price gr. <b>A166</b> (m <sup>2</sup> )	Price gr. <b>A166</b> (m <sup>2</sup> )	Price gr. <b>A178</b> (m <sup>2</sup> )			
dark stone grey <input type="checkbox"/>	<b>555036-32020H<sup>2/4</sup></b>	<b>555036-38110H<sup>2/4</sup></b>	<b>555036-32050H<sup>2/4</sup></b>	<b>555036-42550HK</b>			
	Price gr. <b>A166</b> (m <sup>2</sup> )	Price gr. <b>A166</b> (m <sup>2</sup> )	Price gr. <b>A166</b> (m <sup>2</sup> )	Price gr. <b>A178</b> (m <sup>2</sup> )			
light sand-grey <input type="checkbox"/>	<b>555038-32020H<sup>2/4</sup></b>	<b>555038-38110H<sup>2/4</sup></b>	<b>555038-32050H<sup>2/4</sup></b>	<b>555038-42550HK</b>			
	Price gr. <b>A166</b> (m <sup>2</sup> )	Price gr. <b>A166</b> (m <sup>2</sup> )	Price gr. <b>A166</b> (m <sup>2</sup> )	Price gr. <b>A178</b> (m <sup>2</sup> )			
medium sand-grey <input type="checkbox"/>	<b>555039-32020H<sup>2/4</sup></b>	<b>555039-38110H<sup>2/4</sup></b>	<b>555039-32050H<sup>2/4</sup></b>	<b>555039-42550HK</b>			
	Price gr. <b>A166</b> (m <sup>2</sup> )	Price gr. <b>A166</b> (m <sup>2</sup> )	Price gr. <b>A166</b> (m <sup>2</sup> )	Price gr. <b>A178</b> (m <sup>2</sup> )			
dark sand-grey <input type="checkbox"/>	<b>555040-32020H<sup>2/4</sup></b>	<b>555040-38110H<sup>2/4</sup></b>	<b>555040-32050H<sup>2/4</sup></b>	<b>555040-42550HK</b>			
	Price gr. <b>A166</b> (m <sup>2</sup> )	Price gr. <b>A166</b> (m <sup>2</sup> )	Price gr. <b>A166</b> (m <sup>2</sup> )	Price gr. <b>A178</b> (m <sup>2</sup> )			
neutral 3	<b>555113-32020H<sup>2/4</sup></b>	<b>555113-38110H<sup>2/4</sup></b>	<b>555113-32050H<sup>2/4</sup></b>	<b>555113-42550HK</b>			
(asphalt black) <input type="checkbox"/>	Price gr. <b>A166</b> (m <sup>2</sup> )	Price gr. <b>A166</b> (m <sup>2</sup> )	Price gr. <b>A166</b> (m <sup>2</sup> )	Price gr. <b>A178</b> (m <sup>2</sup> )			
neutral 7	<b>555117-32020H<sup>2/4</sup></b>	<b>555117-38110H<sup>2/4</sup></b>	<b>555117-32050H<sup>2/4</sup></b>	<b>555117-42550HK</b>			
(pebble-grey) <input type="checkbox"/>	Price gr. <b>A166</b> (m <sup>2</sup> )	Price gr. <b>A166</b> (m <sup>2</sup> )	Price gr. <b>A166</b> (m <sup>2</sup> )	Price gr. <b>A178</b> (m <sup>2</sup> )			
neutral 8	<b>555118-32020H<sup>2/4</sup></b>	<b>555118-38110H<sup>2/4</sup></b>	<b>555118-32050H<sup>2/4</sup></b>	<b>555118-42550HK</b>			
(light-grey) <input type="checkbox"/>	Price gr. <b>A166</b> (m <sup>2</sup> )	Price gr. <b>A166</b> (m <sup>2</sup> )	Price gr. <b>A166</b> (m <sup>2</sup> )	Price gr. <b>A178</b> (m <sup>2</sup> )			
natural white <input type="checkbox"/>	<b>901i-32020H</b>	<b>901i-38110H</b>	<b>901i-32050H</b>	<b>901i-42550HK</b>			
	Price gr. <b>A166</b> (m <sup>2</sup> )	Price gr. <b>A166</b> (m <sup>2</sup> )	Price gr. <b>A166</b> (m <sup>2</sup> )	Price gr. <b>A178</b> (m <sup>2</sup> )			



<sup>3</sup> Supplied as double-tiles; to be broken by customer.

<sup>4</sup> Minimum order quantity: 200 m<sup>2</sup>

Quantum

Floor Tiles

12,5 x 12,5 cm<sup>3</sup>



12,5 x 25 cm



25 x 25 cm



25 x 50 cm<sup>1/2/4</sup>

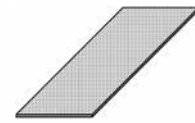

			Grid profile tile	Grid profile tile	Grid profile tile	Grid profile tile	
			32100H	34090H	32080H	42580HK	Model number
			<b>12.5 x 12.5 / 5 x 5</b>	<b>12.5 x 25 / 5 x 10</b>	<b>25 x 25 / 10 x 10</b>	<b>25 x 50 / 10 x 20</b>	Nom. dim. - cm/in
			119 x 119 x 8 mm	119 x 244 x 8 mm	244 x 244 x 8 mm	244 x 494 x 8 mm	Work size
			relief, silky-matt	relief, silky-matt	relief, silky-matt	relief, silky-matt	Surface
			64.000	32.000	16.000	8.000	m <sup>2</sup> - pieces
			15.360	15.360	16.800	17.040	m <sup>2</sup> - kg
			66	33	14	9	Bundle - pieces
			1.031	1.031	0.875	1.125	Bundle - m <sup>2</sup>
			15.840	15.840	14.700	19.170	Bundle - kg
			86.625	86.625	70.875	40.500	Pallet - m <sup>2</sup>
			1,330.560	1,330.560	1,190.700	690.120	Pallet - kg
			Alb	Alb	Alb	Alb	Product standard
			R11/B	R11/B	R11/B	R11/B	Slip resistance
			2	2	2	2	Stress group
			<b>926i-32100H</b>	<b>926i-34090H</b>	<b>926i-32080H</b>	<b>926i-42580HK</b>	neutral 10
			Price gr. A178 (m <sup>2</sup> )	Price gr. A178 (m <sup>2</sup> )	Price gr. A178 (m <sup>2</sup> )	Price gr. A196 (m <sup>2</sup> )	(active white) <input type="checkbox"/>
			<b>918i-32100H</b>	<b>918i-34090H</b>	<b>918i-32080H</b>	<b>918i-42580HK</b>	neutral 1
			Price gr. A178 (m <sup>2</sup> )	Price gr. A178 (m <sup>2</sup> )	Price gr. A178 (m <sup>2</sup> )	Price gr. A196 (m <sup>2</sup> )	(deep black) <input type="checkbox"/>
			555023-32100H <sup>2/4</sup>	555023-34090H <sup>2/4</sup>	555023-32080H <sup>2/4</sup>	555023-42580HK	
			Price gr. A178 (m <sup>2</sup> )	Price gr. A178 (m <sup>2</sup> )	Price gr. A178 (m <sup>2</sup> )	Price gr. A196 (m <sup>2</sup> )	medium ochre <input type="checkbox"/>
			555035-32100H <sup>2/4</sup>	555035-34090H <sup>2/4</sup>	555035-32080H <sup>2/4</sup>	555035-42580HK	
			Price gr. A178 (m <sup>2</sup> )	Price gr. A178 (m <sup>2</sup> )	Price gr. A178 (m <sup>2</sup> )	Price gr. A196 (m <sup>2</sup> )	medium stone grey <input type="checkbox"/>
			555036-32100H <sup>2/4</sup>	555036-34090H <sup>2/4</sup>	555036-32080H <sup>2/4</sup>	555036-42580HK	
			Price gr. A178 (m <sup>2</sup> )	Price gr. A178 (m <sup>2</sup> )	Price gr. A178 (m <sup>2</sup> )	Price gr. A196 (m <sup>2</sup> )	dark stone grey <input type="checkbox"/>
			555038-32100H <sup>2/4</sup>	555038-34090H <sup>2/4</sup>	555038-32080H <sup>2/4</sup>	555038-42580HK	
			Price gr. A178 (m <sup>2</sup> )	Price gr. A178 (m <sup>2</sup> )	Price gr. A178 (m <sup>2</sup> )	Price gr. A196 (m <sup>2</sup> )	light sand-grey <input type="checkbox"/>
			555039-32100H <sup>2/4</sup>	555039-34090H <sup>2/4</sup>	555039-32080H <sup>2/4</sup>	555039-42580HK	
			Price gr. A178 (m <sup>2</sup> )	Price gr. A178 (m <sup>2</sup> )	Price gr. A178 (m <sup>2</sup> )	Price gr. A196 (m <sup>2</sup> )	medium sand-grey <input type="checkbox"/>
			555040-32100H <sup>2/4</sup>	555040-34090H <sup>2/4</sup>	555040-32080H <sup>2/4</sup>	555040-42580HK	
			Price gr. A178 (m <sup>2</sup> )	Price gr. A178 (m <sup>2</sup> )	Price gr. A178 (m <sup>2</sup> )	Price gr. A196 (m <sup>2</sup> )	dark sand-grey <input type="checkbox"/>
			555113-32100H <sup>2/4</sup>	555113-34090H <sup>2/4</sup>	555113-32080H <sup>2/4</sup>	555113-42580HK	
			Price gr. A178 (m <sup>2</sup> )	Price gr. A178 (m <sup>2</sup> )	Price gr. A178 (m <sup>2</sup> )	Price gr. A196 (m <sup>2</sup> )	neutral 3
			555117-32100H <sup>2/4</sup>	555117-34090H <sup>2/4</sup>	555117-32080H <sup>2/4</sup>	555117-42580HK	(asphalt black) <input type="checkbox"/>
			Price gr. A178 (m <sup>2</sup> )	Price gr. A178 (m <sup>2</sup> )	Price gr. A178 (m <sup>2</sup> )	Price gr. A196 (m <sup>2</sup> )	neutral 7
			555118-32100H <sup>2/4</sup>	555118-34090H <sup>2/4</sup>	555118-32080H <sup>2/4</sup>	555118-42580HK	(pebble-grey) <input type="checkbox"/>
			Price gr. A178 (m <sup>2</sup> )	Price gr. A178 (m <sup>2</sup> )	Price gr. A178 (m <sup>2</sup> )	Price gr. A196 (m <sup>2</sup> )	neutral 8
			901i-32100H	901i-34090H	901i-32080H	901i-42580HK	(light-grey) <input type="checkbox"/>
			Price gr. A178 (m <sup>2</sup> )	Price gr. A178 (m <sup>2</sup> )	Price gr. A178 (m <sup>2</sup> )	Price gr. A196 (m <sup>2</sup> )	natural white <input type="checkbox"/>



<sup>3</sup> Supplied as double-tiles; to be broken by customer.

<sup>4</sup> Minimum order quantity: 200 m<sup>2</sup>



Quantum

Shower Tub System<sup>2</sup>

12,5 x 25 cm



12,5 x 12,5 cm



12,5 x 12,5 cm



Lip 10 mm Strip

Lip 10 mm Strip

Corner

Model number	27182H	27180H	27181H
Nom. dim. - cm/in	12.5 x 25 / 5 x 10	12.5 x 12.5 / 5 x 5	12.5 x 12.5 / 5 x 5
Work size	119 x 244 x 18/8 mm	119 x 119 x 18/8 mm	119 x 119 x 18/8 mm
Surface	smooth, silky-matt	smooth, silky-matt	smooth, silky-matt
m - pieces	4.000	8.000	
m/pce. - kg	2.720/m	2.720/m	0.500/Stück
Bundle - pieces	22	44	12
Bundle - m	5.500	5.500	
Bundle - kg	14.960	14.960	6.000
Pallet - m			
Pallet - kg			
Product standard	Alb	Alb	Alb
Slip resistance	R10/B	R10/B	R10/B
neutral 10	<b>926i-27182H</b>	<b>926i-27180H</b>	<b>926i-27181H</b>
(active white) <input type="checkbox"/>	Price gr. A506 (pce.)	Price gr. A455 (pce.)	Price gr. A489 (pce.)
neutral 1	<b>918i-27182H</b>	<b>918i-27180H</b>	<b>918i-27181H</b>
(deep black) <input type="checkbox"/>	Price gr. A506 (pce.)	Price gr. A455 (pce.)	Price gr. A489 (pce.)
medium ochre <input type="checkbox"/>	555023-27182H <sup>1</sup>	555023-27180H <sup>1</sup>	555023-27181H <sup>1</sup>
	Price gr. A506 (pce.)	Price gr. A455 (pce.)	Price gr. A489 (pce.)
medium stone grey <input type="checkbox"/>	555035-27182H <sup>1</sup>	555035-27180H <sup>1</sup>	555035-27181H <sup>1</sup>
	Price gr. A506 (pce.)	Price gr. A455 (pce.)	Price gr. A489 (pce.)
dark stone grey <input type="checkbox"/>	555036-27182H <sup>1</sup>	555036-27180H <sup>1</sup>	555036-27181H <sup>1</sup>
	Price gr. A506 (pce.)	Price gr. A455 (pce.)	Price gr. A489 (pce.)
light sand-grey <input type="checkbox"/>	555038-27182H <sup>1</sup>	555038-27180H <sup>1</sup>	555038-27181H <sup>1</sup>
	Price gr. A506 (pce.)	Price gr. A455 (pce.)	Price gr. A489 (pce.)
medium sand-grey <input type="checkbox"/>	555039-27182H <sup>1</sup>	555039-27180H <sup>1</sup>	555039-27181H <sup>1</sup>
	Price gr. A506 (pce.)	Price gr. A455 (pce.)	Price gr. A489 (pce.)
dark sand-grey <input type="checkbox"/>	555040-27182H <sup>1</sup>	555040-27180H <sup>1</sup>	555040-27181H <sup>1</sup>
	Price gr. A506 (pce.)	Price gr. A455 (pce.)	Price gr. A489 (pce.)
neutral 3	555113-27182H <sup>1</sup>	555113-27180H <sup>1</sup>	555113-27181H <sup>1</sup>
(asphalt black) <input type="checkbox"/>	Price gr. A506 (pce.)	Price gr. A455 (pce.)	Price gr. A489 (pce.)
neutral 7	555117-27182H <sup>1</sup>	555117-27180H <sup>1</sup>	555117-27181H <sup>1</sup>
(pebble-grey) <input type="checkbox"/>	Price gr. A506 (pce.)	Price gr. A455 (pce.)	Price gr. A489 (pce.)
neutral 8	555118-27182H <sup>1</sup>	555118-27180H <sup>1</sup>	555118-27181H <sup>1</sup>
(light-grey) <input type="checkbox"/>	Price gr. A506 (pce.)	Price gr. A455 (pce.)	Price gr. A489 (pce.)
natural white <input type="checkbox"/>	<b>901i-27182H</b>	<b>901i-27180H</b>	<b>901i-27181H</b>
	Price gr. A506 (pce.)	Price gr. A455 (pce.)	Price gr. A489 (pce.)



<sup>2</sup> For details, refer to page 535

## Quantum

### Safety Strip Tile<sup>1/2</sup>

6,2 x 25 cm



*rounded  
long edge*

### Skirtings<sup>1</sup>

7,9 x 25 cm



*Skirting*

12,5 x 25 cm



*Cove Skirting,  
r = 12 mm*



*External Corner  
mitred pair*



*Internal Corner  
mitred pair*

	<i>rounded long edge</i>	<i>Skirting</i>	<i>Cove Skirting, r = 12 mm</i>	<i>External Corner mitred pair</i>	<i>Internal Corner mitred pair</i>	
	34306H	34020H	37080	37081	37082	Model number
	<b>6.2 x 25</b> / 2 1/2 x 10	<b>7.9 x 25</b> / 3 1/8 x 10	<b>12.5 x 25</b> / 5 x 10			Nom. dim. - <b>cm/in</b>
	56 x 244 x 8 mm	73 x 244 x 8 mm	125 x 244/12 x 8 mm	(2x) 131 x 125/12 x 8 mm	(2x) 119 x 125/12 x 8 mm	Work size
	gerillt, silky-matt	smooth, silky-matt	smooth, silky-matt	smooth, silky-matt	smooth, silky-matt	Surface
	4.000	4.000	4.000			<b>m</b> - pieces
	0.800/m	1.160/m	2.520/m	0.600/pair	0.400/pair	<b>m/pair</b> - kg
	66 Stück	33 Stück	20 Stück	10 pair	10 pair	<b>Bundle</b> - pce./pair
	16.500	8.250	5.000			<b>Bundle</b> - m
	13.200	9.570	12.600	6.000	4.000	<b>Bundle</b> - kg
						<b>Pallet</b> - m
						<b>Pallet</b> - kg
	Alb	Alb	Alb	Alb	Alb	Product standard
	-/C		R10/A	R10/A	R10/A	Slip resistance
		<b>926i-34020H</b>	<b>926-37080</b>	<b>926-37081</b>	<b>926-37082</b>	neutral 10
		Price gr. <b>A410</b> (pce.)	Price gr. <b>A423</b> (pce.)	Price gr. <b>A455</b> (pair)	Price gr. <b>A455</b> (pair)	(active white) <input type="checkbox"/> <b>V0</b>
	<b>918i-34306H</b>	<b>918i-34020H</b>	<b>918-37080</b>	<b>918-37081</b>	<b>918-37082</b>	neutral 1
	Price gr. <b>A434</b> (pce.)	Price gr. <b>A410</b> (pce.)	Price gr. <b>A423</b> (pce.)	Price gr. <b>A455</b> (pair)	Price gr. <b>A455</b> (pair)	(deep black) <input type="checkbox"/> <b>V0</b>
		<b>901i-34020H</b>	<b>901-37080</b>	<b>901-37081</b>	<b>901-37082</b>	natural white <input type="checkbox"/> <b>V0</b>
		Price gr. <b>A410</b> (pce.)	Price gr. <b>A423</b> (pce.)	Price gr. <b>A455</b> (pair)	Price gr. <b>A455</b> (pair)	



<sup>2</sup> Especially suitable for non-slip and clearly visible (stair) edge design.









## Harmonious feeling of homeliness

With its wall tiles in the colors silver-grey and sand-beige, the series Concrete creates a natural and harmonious living atmosphere. Eye-catching accents can be set with the Screen and Stripes mosaic tiles in graphite and sand-beige along with the matching borders. The wall tiles are easy to clean thanks to their Hytect surface.

Studio photo



Wall tile 30 x 60 cm, 12 x 24 in, silver-grey, structured



Wall tile 30 x 60 cm, 12 x 24 in, sand-beige, structured

## Decoration Elements

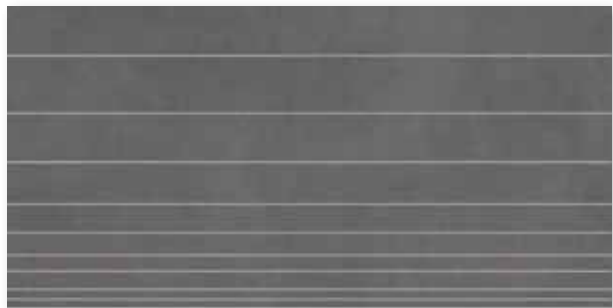

Mosaic tile Stripes 30 x 60 cm, 12 x 24 in, anthracite, structured



Mosaic tile Stripes 30 x 60 cm, 12 x 24 in, sand-beige, structured

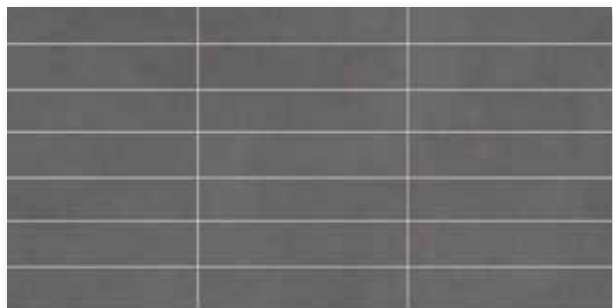

Mosaic tile Screen 30 x 60 cm, 12 x 24 in, anthracite, structured

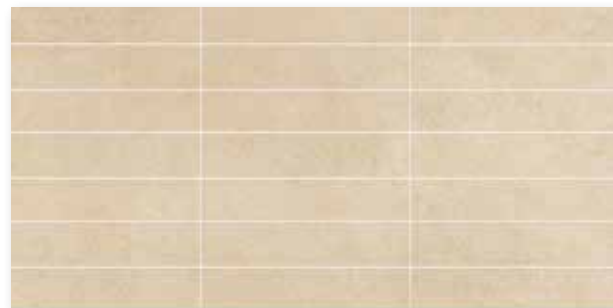

Mosaic tile Screen 30 x 60 cm, 12 x 24 in, sand-beige, structured

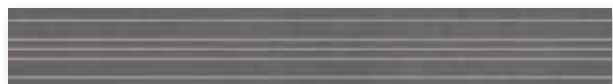

Border Stripes 8 x 60 cm, 3.2 x 24 in, anthracite, structured



Border Stripes 8 x 60 cm, 3.2 x 24 in, sand-beige, structured

Wall Tiles<sup>2</sup> Decoration Elements<sup>1/3</sup>

30 x 60 cm



30 x 60 cm



30 x 60 cm<sup>4</sup>

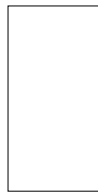

30 x 60 cm

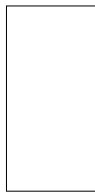

30 x 60 cm<sup>4</sup>



8 x 60 cm



8 x 60 cm<sup>4</sup>



	Mosaic tile Stripes	Mosaic tile Stripes	Mosaic tile Screen	Mosaic tile Screen	Border Stripes	Border Stripes	
<b>30 x 60 / 12 x 24</b>	<b>30 x 60 / 12 x 24</b>	<b>30 x 60 / 12 x 24</b>	<b>30 x 60 / 12 x 24</b>	<b>30 x 60 / 12 x 24</b>	<b>8 x 60 / 3 3/16 x 24</b>	<b>8 x 60 / 3 3/16 x 24</b>	Nom. dim. - <b>cm/in</b>
296 x 595 x 9 mm	297 x 597 x 10.5 mm	296 x 595 x 10 mm	297 x 597 x 10.5 mm	296 x 595 x 10 mm	80 x 597 x 10.5 mm	80 x 595 x 10 mm	Work size
structured, silky-matt	structured, matt	structured, matt	structured, matt	structured, matt	structured, matt	structured, matt	Surface
5.556/m <sup>2</sup>	1.667/m	1.667/m	1.667/m	1.667/m	1.667/m	1.667/m	<b>m<sup>2</sup></b> - pieces
14.946/m <sup>2</sup>	6.668/m	6.668/m	6.668/m	6.668/m	1.779/m	1.779/m	<b>m<sup>2</sup></b> - kg
9	2	2	2	2	4	4	<b>Bundle</b> - pieces
1.620 m <sup>2</sup>	1.200 m	1.200 m	1.200 m	1.200 m	2.400 m	2.400 m	<b>Bundle</b> - m <sup>2</sup>
24.210	8.000	8.000	8.000	8.000	4.268	4.268	<b>Bundle</b> - kg
77.754							<b>Pallet</b> - m <sup>2</sup>
1,162.080							<b>Pallet</b> - kg
BIII	Bla	Bla	Bla	Bla	Bla	Bla	Product standard
<b>280345</b>							silver-grey <input type="checkbox"/> V2
Price gr. <b>C56</b> (m <sup>2</sup> )							sand-beige <input type="checkbox"/> V2
<b>280354</b>		<b>280360</b>		<b>280362</b>		<b>280361</b>	anthracite <input type="checkbox"/> V2
Price gr. <b>C56</b> (m <sup>2</sup> )		Price gr. <b>C486</b> (pce.)		Price gr. <b>C491</b> (pce.)		Price gr. <b>C447</b> (pce.)	
	<b>280349-73</b>		<b>280351-73</b>		<b>280350-73</b>		
	Price gr. <b>C486</b> (pce.)		Price gr. <b>C491</b> (pce.)		Price gr. <b>C447</b> (pce.)		



<sup>1</sup>   
<sup>2</sup> not frost-proof   
<sup>3</sup> Decoration elements only available in full boxes.   
<sup>4</sup> without Hytect coating





## Inspiring and modern

The heritage hype in fashion, lifestyle and technology which has been going on for years has also left its mark on tiles. Craft evokes familiarity while appearing surprisingly modern. Equally suited for indoor and outdoor use, the series owes its handcrafted character to the depth and transparency of its high-gloss glaze. Compositions of alkaline earths, fluxes, and metal oxides interacting with the clay body create particularly luminous, intense colors and typical surface structures when the tiles are fired openly.

Bar Bardem, Helsinki, Finland / Architect: Fyra Ltd.  
Photo: Riikka Kantinkoski

**Mono-colors Flamed colors**

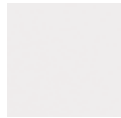

pure white



olive-green flamed



white



golden-yellow flamed



medium grey



amber flamed



dark grey



blue-green flamed



jade-green



beryl-red



benit-blue



hematite-black

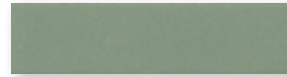

Strip tile 6.2 x 25 cm, 2 1/2 x 10 in, smooth



Strip tile, wave profile 6.2 x 25 cm, 2 1/2 x 10 in, profiled



Strip tile, grooved profile 6.2 x 25 cm, 2 1/2 x 10 in, profiled



Strip tile, V-pointed profile 6.2 x 25 cm, 2 1/2 x 10 in, profiled



Double-tip tile 12.5 x 25 cm, 5 x 10 in, profiled

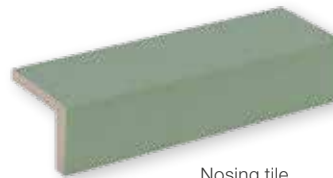

Nosing tile  
6.2 x 25 cm, 2 1/2 x 10 in,  
smooth

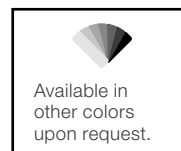



Strip tile 6.2 x 25 cm, 2 1/2 x 10 in



Strip tile, wave profile 6.2 x 25 cm, 2 1/2 x 10 in



Double-tip strip tile 12.5 x 25 cm, 5 x 10 in



Strip tile, V-pointed profile 6.2 x 25 cm, 2 1/2 x 10 in



Strip tile, grooved profile 6.2 x 25 cm, 2 1/2 x 10 in



Strip Tiles<sup>2</sup>

Double-Tip  
Tile

Nosing Tile, **NEW**  
glued<sup>1/4</sup>

6,2 x 25 cm



6,2 x 25 cm



6,2 x 25 cm<sup>5</sup>



6,2 x 25 cm



12,5 x 25 cm



6,2 x 25 cm



	2120	2250	2270	2280	2240	2821	Model number
	<b>6.2 x 25 / 2 1/2 x 10</b>	<b>6.2 x 25 / 2 1/2 x 10</b>	<b>6.2 x 25 / 2 1/2 x 10</b>	<b>6.2 x 25 / 2 1/2 x 10</b>	<b>12.5 x 25 / 5 x 10</b>	<b>6.2 x 25 / 2 1/2 x 10</b>	Nom. dim. - cm/in
	52 x 240 x 11 mm	52 x 240 x 16/11 mm	52 x 240 x 18/11 mm	52 x 240 x 11 mm	115 x 240 x 20/11 mm	52 x 52 x 240 x 11 mm	Work size
	smooth, glossy	profiled, glossy	profiled, glossy	profiled, glossy	profiled, glossy	smooth, glossy	Surface
	67.000/m <sup>2</sup>	67.000/m <sup>2</sup>	67.000/m <sup>2</sup>	67.000/m <sup>2</sup>	33.000/m <sup>2</sup>	4.000/m	m <sup>2</sup> - pieces
	20.100/m <sup>2</sup>	21.775/m <sup>2</sup>	27.470/m <sup>2</sup>	21.440/m <sup>2</sup>	27.060/m <sup>2</sup>	2.400/m	m <sup>2</sup> - kg
	46	34	30	44	14		Bundle - pieces
	0.687	0.507	0.448	0.657	0.209		Bundle - m <sup>2</sup>
	13.800	11.050	12.300	14.080	11.480		Bundle - kg
	57.678	42.627	37.612	55.164	35.636		Pallet - m <sup>2</sup>
	1,159.200	928.200	1,033.200	1,182.720	964.320		Pallet - kg
	Alla	Alla	Alla	Alla	Alla	Alla	Product standard
							Slip resistance
							Stress group
	<b>9027-2120H</b>	<b>9027-2250H</b>	<b>9027-2270H</b>	<b>9027-2280H</b>	<b>9027-2240H</b>	<i>9027-2821H</i>	pure white <input type="checkbox"/> V1
	Price gr. <b>A187</b> (m <sup>2</sup> )	Price gr. <b>A253</b> (m <sup>2</sup> )	Price gr. <b>A253</b> (m <sup>2</sup> )	Price gr. <b>A253</b> (m <sup>2</sup> )	Price gr. <b>A268</b> (m <sup>2</sup> )		
	<b>9026-2120H</b>	<b>9026-2250H</b>	<b>9026-2270H</b>	<b>9026-2280H</b>	<b>9026-2240H</b>	<i>9026-2821H</i>	white <input type="checkbox"/> V1
	Price gr. <b>A187</b> (m <sup>2</sup> )	Price gr. <b>A253</b> (m <sup>2</sup> )	Price gr. <b>A253</b> (m <sup>2</sup> )	Price gr. <b>A253</b> (m <sup>2</sup> )	Price gr. <b>A268</b> (m <sup>2</sup> )		
	<b>9022-2120H</b>	<b>9022-2250H</b>	<b>9022-2270H</b>	<b>9022-2280H</b>	<b>9022-2240H</b>	<i>9022-2821H</i>	mid-grey <input type="checkbox"/> V1
	Price gr. <b>A187</b> (m <sup>2</sup> )	Price gr. <b>A253</b> (m <sup>2</sup> )	Price gr. <b>A253</b> (m <sup>2</sup> )	Price gr. <b>A253</b> (m <sup>2</sup> )	Price gr. <b>A268</b> (m <sup>2</sup> )		
	<b>9021-2120H</b>	<i>9021-2250H<sup>1/3</sup></i>	<i>9021-2270H<sup>1/3</sup></i>	<i>9021-2280H<sup>1/3</sup></i>	<i>9021-2240H<sup>1/3</sup></i>	<i>9021-2821H</i>	dark-grey <input type="checkbox"/> V1
	Price gr. <b>A187</b> (m <sup>2</sup> )	Price gr. <b>A253</b> (m <sup>2</sup> )	Price gr. <b>A253</b> (m <sup>2</sup> )	Price gr. <b>A253</b> (m <sup>2</sup> )	Price gr. <b>A268</b> (m <sup>2</sup> )		
	<b>9020-2120H</b>	<b>9020-2250H</b>	<b>9020-2270H</b>	<b>9020-2280H</b>	<b>9020-2240H</b>	<i>9020-2821H</i>	olive-green <input type="checkbox"/> V2
	Price gr. <b>A187</b> (m <sup>2</sup> )	Price gr. <b>A253</b> (m <sup>2</sup> )	Price gr. <b>A253</b> (m <sup>2</sup> )	Price gr. <b>A253</b> (m <sup>2</sup> )	Price gr. <b>A268</b> (m <sup>2</sup> )		flamed <input type="checkbox"/> V2
	<b>9023-2120H</b>	<i>9023-2250H<sup>1/3</sup></i>	<i>9023-2270H<sup>1/3</sup></i>	<i>9023-2280H<sup>1/3</sup></i>	<i>9023-2240H<sup>1/3</sup></i>	<i>9023-2821H</i>	golden-yellow <input type="checkbox"/> V3
	Price gr. <b>A187</b> (m <sup>2</sup> )	Price gr. <b>A253</b> (m <sup>2</sup> )	Price gr. <b>A253</b> (m <sup>2</sup> )	Price gr. <b>A253</b> (m <sup>2</sup> )	Price gr. <b>A268</b> (m <sup>2</sup> )		flamed <input type="checkbox"/> V3
	<b>9025-2120H</b>	<b>9025-2250H</b>	<b>9025-2270H</b>	<b>9025-2280H</b>	<b>9025-2240H</b>	<i>9025-2821H</i>	amber <input type="checkbox"/> V2
	Price gr. <b>A253</b> (m <sup>2</sup> )	Price gr. <b>A253</b> (m <sup>2</sup> )	Price gr. <b>A253</b> (m <sup>2</sup> )	Price gr. <b>A253</b> (m <sup>2</sup> )	Price gr. <b>A268</b> (m <sup>2</sup> )		flamed <input type="checkbox"/> V2
	<b>9024-2120H</b>	<b>9024-2250H</b>	<b>9024-2270H</b>	<b>9024-2280H</b>	<b>9024-2240H</b>	<i>9024-2821H</i>	blue green <input type="checkbox"/> V3
	Price gr. <b>A187</b> (m <sup>2</sup> )	Price gr. <b>A253</b> (m <sup>2</sup> )	Price gr. <b>A253</b> (m <sup>2</sup> )	Price gr. <b>A253</b> (m <sup>2</sup> )	Price gr. <b>A268</b> (m <sup>2</sup> )		flamed <input type="checkbox"/> V3
	<b>9030-2120H</b>	<b>9030-2250H</b>	<b>9030-2270H</b>	<b>9030-2280H</b>	<b>9030-2240H</b>	<i>9030-2821H</i>	jade-green <input type="checkbox"/> V1
	Price gr. <b>A187</b> (m <sup>2</sup> )	Price gr. <b>A253</b> (m <sup>2</sup> )	Price gr. <b>A253</b> (m <sup>2</sup> )	Price gr. <b>A253</b> (m <sup>2</sup> )	Price gr. <b>A268</b> (m <sup>2</sup> )		
	<b>9031-2120H</b>	<i>9031-2250H<sup>1/3</sup></i>	<i>9031-2270H<sup>1/3</sup></i>	<i>9031-2280H<sup>1/3</sup></i>	<i>9031-2240H<sup>1/3</sup></i>	<i>9031-2821H</i>	beryl-red <input type="checkbox"/> V1
	Price gr. <b>A187</b> (m <sup>2</sup> )	Price gr. <b>A253</b> (m <sup>2</sup> )	Price gr. <b>A253</b> (m <sup>2</sup> )	Price gr. <b>A253</b> (m <sup>2</sup> )	Price gr. <b>A268</b> (m <sup>2</sup> )		
	<b>9032-2120H</b>	<i>9032-2250H<sup>1/3</sup></i>	<i>9032-2270H<sup>1/3</sup></i>	<i>9032-2280H<sup>1/3</sup></i>	<i>9032-2240H<sup>1/3</sup></i>	<i>9032-2821H</i>	benit-blue <input type="checkbox"/> V1
	Price gr. <b>A187</b> (m <sup>2</sup> )	Price gr. <b>A253</b> (m <sup>2</sup> )	Price gr. <b>A253</b> (m <sup>2</sup> )	Price gr. <b>A253</b> (m <sup>2</sup> )	Price gr. <b>A268</b> (m <sup>2</sup> )		
	<b>9033-2120H</b>	<i>9033-2250H<sup>1/3</sup></i>	<i>9033-2270H<sup>1/3</sup></i>	<i>9033-2280H<sup>1/3</sup></i>	<i>9033-2240H<sup>1/3</sup></i>	<i>9033-2821H</i>	hematite-black <input type="checkbox"/> V1
	Price gr. <b>A187</b> (m <sup>2</sup> )	Price gr. <b>A253</b> (m <sup>2</sup> )	Price gr. <b>A253</b> (m <sup>2</sup> )	Price gr. <b>A253</b> (m <sup>2</sup> )	Price gr. <b>A268</b> (m <sup>2</sup> )		



<sup>2</sup> Supplied as double-tiles; to be broken by customer.

<sup>3</sup> Minimum order quantity: 250 m<sup>2</sup>

<sup>4</sup> The format 2821 is produced with a glued edge. The price is calculated project-specifically.

<sup>5</sup> For format 2270: Due to manufacturing reasons, right and left overglazed short edges are generated at a ratio of 1:1 in the case of this article, which have to be purchased by the customer. Only one longitudinal edge can be glazed.

For the series Craft:

Minimum order quantity in the case of special colors: 500 m<sup>2</sup>

Price for lower quantities on request.

The customer agrees to purchase a possible overproduction of 10 %.

Overglazed edge(s) possible up to max. 25 % of the order quantity.

A separate order is necessary.

The nosing tiles 12.5 x 25 cm can be produced with glued edge on request. The price is calculated project-specifically.



Residential quarter Bellaria, Zürich-Wollishofen, Switzerland / Architect: Michael Meier and Marius Hug Architekten AG, Zurich, Switzerland / Photo: Adriano Faragulo

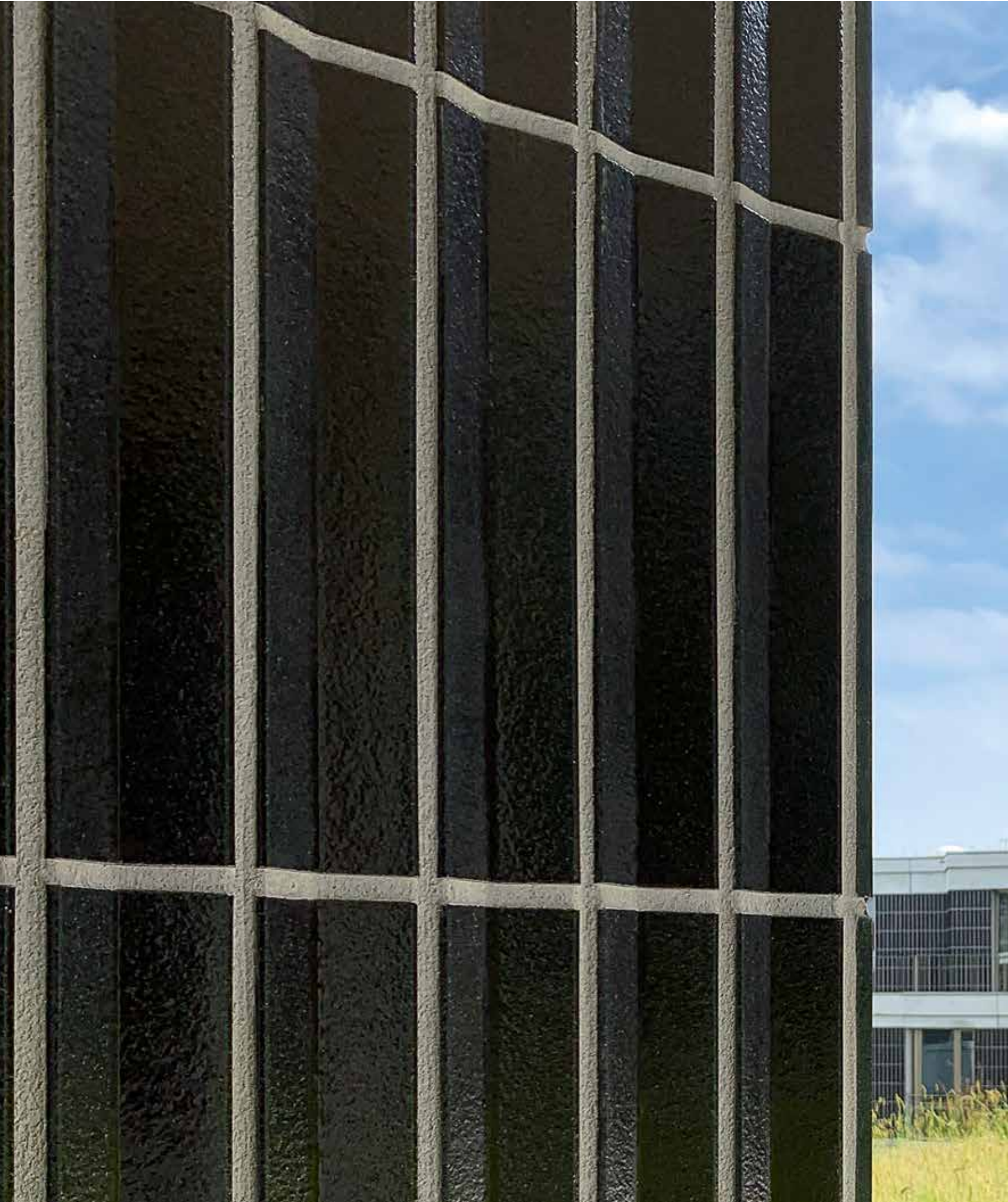



**Mono-colors**

**Flamed colors**



lime-white



natural-white



pearl-grey



natural-grey



reseda-green



crimson



cobalt-blue

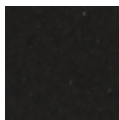

deep black



reed-green flamed



red-brown flamed



petrol-blue flamed



Long strip tile 6.2 x 50 cm, 2 1/2 x 20 in, smooth



Long strip tile, V-pointed profile, symmetrical 6.2 x 50 cm, 2 1/2 x 20 in, profiled



Cover tile, drip edge, 31 x 30 cm, 12 13/64 x 12 in, smooth

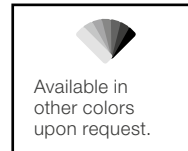

6,2 x 50 cm

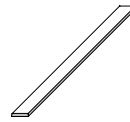

Strip Tile

6,2 x 50 cm

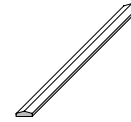

Long strip tile,  
V-pointed  
profile, symmetrical

31 x 30 cm<sup>1</sup>

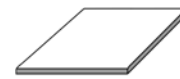

Cover tile,  
drip edge



				2320	2290	9215			Model number
				<b>6.2 x 50</b> / 2 1/2 x 20	<b>6.2 x 50</b> / 2 1/2 x 20	<b>31 x 30</b> / 12 13/64 x 12			Nom. dim. - cm/in
				52 x 490 x 11 mm	52 x 490 x 18/11 mm	300 x 300 x 15 mm			Work size
				smooth, glossy	profiled, glossy	smooth, glossy			Surface
				32.258/m <sup>2</sup>	32.258/m <sup>2</sup>	3.226/m			m <sup>2</sup> /m - pieces
				18.710/m <sup>2</sup>	27.097 m <sup>2</sup>	8.904/m			m <sup>2</sup> /m - kg
				22	13	8			Bundle - pieces
				0.682 m <sup>2</sup>	0.403 m <sup>2</sup>	2.480 m			Bundle - m <sup>2</sup> /m
				12.760	10.920	22.080			Bundle - kg
				40.920	24.180				Pallet - m <sup>2</sup>
				765.600	655.200				Pallet - kg
				Alla	Alla	Alla			Product standard
				<b>19027-2320H</b>	<b>19027-2290H</b>	19027-9215H			lime-white <input type="checkbox"/> V1
				Price gr. A175 (m <sup>2</sup> )	Price gr. A274 (m <sup>2</sup> )	Price gr. A471 (pce.)			
				<b>19026-2320H</b>	<b>19026-2290H</b>	19026-9215H			natural white <input type="checkbox"/> V1
				Price gr. A175 (m <sup>2</sup> )	Price gr. A274 (m <sup>2</sup> )	Price gr. A471 (pce.)			
				<b>19022-2320H</b>	<b>19022-2290H</b>	19022-9215H			pearl-grey <input type="checkbox"/> V1
				Price gr. A175 (m <sup>2</sup> )	Price gr. A274 (m <sup>2</sup> )	Price gr. A471 (pce.)			
				<b>19021-2320H</b>	<b>19021-2290H</b> <sup>1/2</sup>	19021-9215H			natural-grey <input type="checkbox"/> V1
				Price gr. A175 (m <sup>2</sup> )	Price gr. A274 (m <sup>2</sup> )	Price gr. A471 (pce.)			
				<b>19020-2320H</b>	<b>19020-2290H</b>	19020-9215H			reed-green <input type="checkbox"/> V2
				Price gr. A175 (m <sup>2</sup> )	Price gr. A274 (m <sup>2</sup> )	Price gr. A471 (pce.)			
				<b>19025-2320H</b>	<b>19025-2290H</b>	19025-9215H			flamed <input type="checkbox"/> V3
				Price gr. A175 (m <sup>2</sup> )	Price gr. A274 (m <sup>2</sup> )	Price gr. A471 (pce.)			
				<b>19024-2320H</b>	<b>19024-2290H</b>	19024-9215H			petrol-blue <input type="checkbox"/> V3
				Price gr. A175 (m <sup>2</sup> )	Price gr. A274 (m <sup>2</sup> )	Price gr. A471 (pce.)			
				<b>19030-2320H</b>	<b>19030-2290H</b>	19030-9215H			reseda-green <input type="checkbox"/> V1
				Price gr. A175 (m <sup>2</sup> )	Price gr. A274 (m <sup>2</sup> )	Price gr. A471 (pce.)			
				<b>19031-2320H</b>	<b>19031-2290H</b> <sup>1/2</sup>	19031-9215H			crimson <input type="checkbox"/> V1
				Price gr. A175 (m <sup>2</sup> )	Price gr. A274 (m <sup>2</sup> )	Price gr. A471 (pce.)			
				<b>19032-2320H</b>	<b>19032-2290H</b> <sup>1/2</sup>	19032-9215H			cobalt blue <input type="checkbox"/> V1
				Price gr. A175 (m <sup>2</sup> )	Price gr. A274 (m <sup>2</sup> )	Price gr. A471 (pce.)			
				<b>19033-2320H</b>	<b>19033-2290H</b> <sup>1/2</sup>	19033-9215H			deep black <input type="checkbox"/> V1
				Price gr. A175 (m <sup>2</sup> )	Price gr. A274 (m <sup>2</sup> )	Price gr. A471 (pce.)			



<sup>1</sup>



<sup>2</sup> Minimum order quantity: 250 m<sup>2</sup>

For the series Craft Extended:

Minimum order quantity in the case of special colors: 500 m<sup>2</sup>

Price for lower quantities on request.

The customer agrees to purchase a possible overproduction of 10 %.

Overglazed edge(s) possible up to max. 25 % of the order quantity,  
a separate order is necessary.



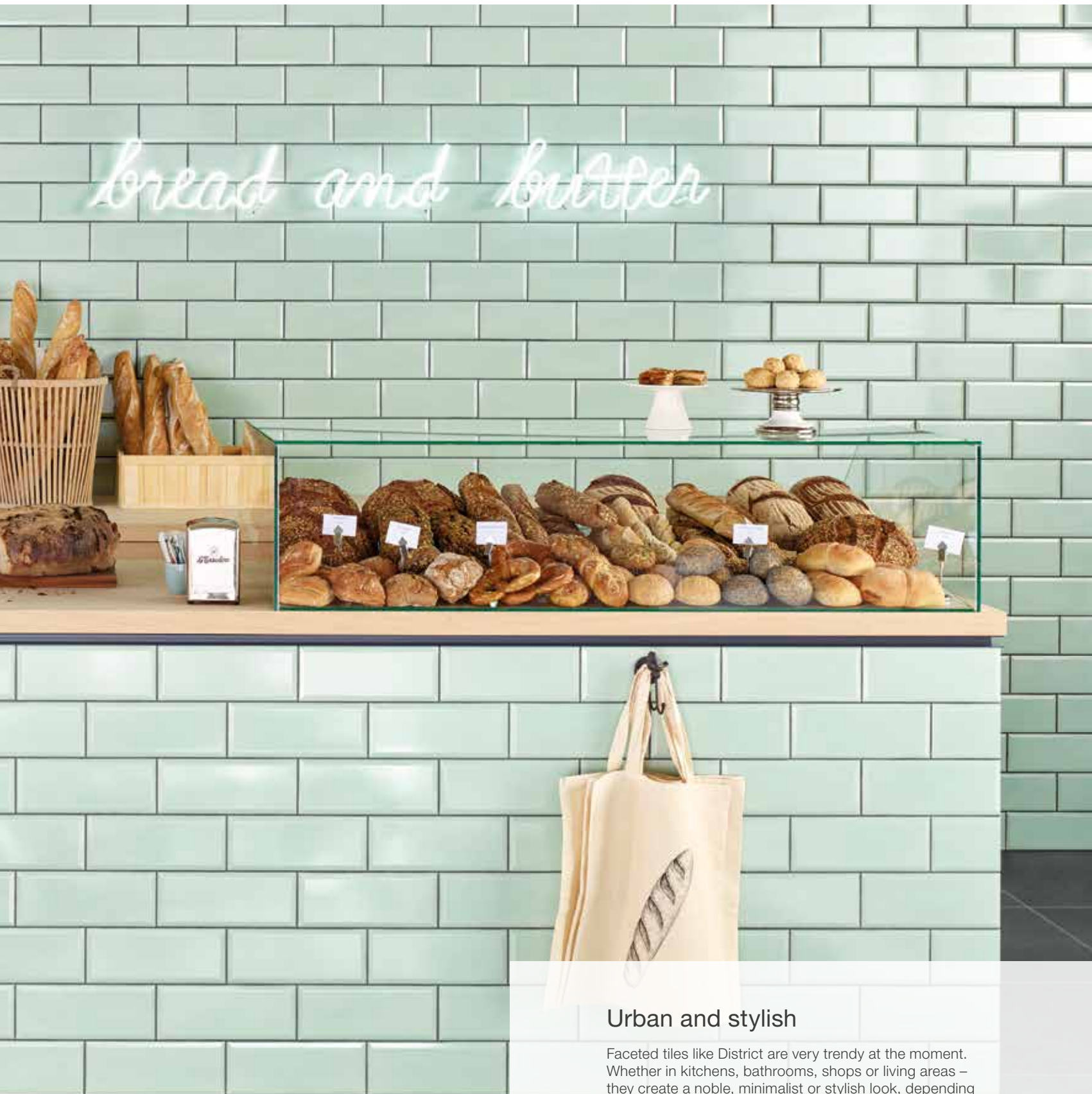

## Urban and stylish

Faceted tiles like District are very trendy at the moment. Whether in kitchens, bathrooms, shops or living areas – they create a noble, minimalist or stylish look, depending on the color and area of application. With District, there are eight trendy colors to choose from. All are available in the formats of 5 x 10 cm and 10 x 25 cm. Thanks to the thermoplastic glueing on the back in the case of the 5 x 10 cm format, they are particularly easy to lay as sheets in addition.

Studio photo / Architect: VSBL, Belgrade, Serbia / Photo: Jochen Stüber



Wall tile 5 x 10 cm, 2 x 4 in, Facette almond beige, relief

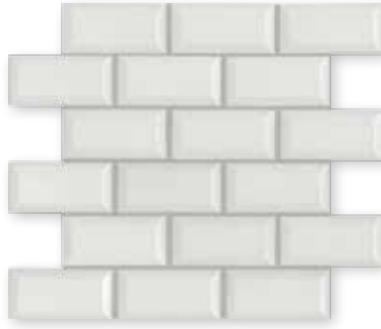

Wall tile 5 x 10 cm, 2 x 4 in, Facette white, relief



Wall tile 10 x 25 cm, 4 x 10 in, Facette almond beige, relief

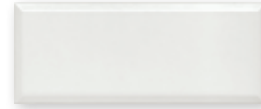

Wall tile 10 x 25 cm, 4 x 10 in, Facette white, relief

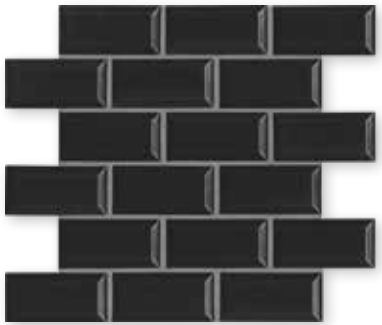

Wall tile 5 x 10 cm, 2 x 4 in, Facette pitch black, relief



Wall tile 5 x 10 cm, 2 x 4 in, Facette ash grey, relief



Wall tile 10 x 25 cm, 4 x 10 in, Facette pitch black, relief



Wall tile 10 x 25 cm, 4 x 10 in, Facette ash grey, relief



Wall tile 5 x 10 cm, 2 x 4 in, Facette miami mint, relief

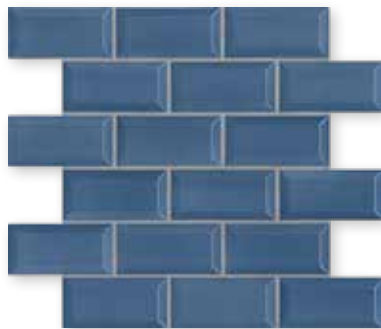

Wall tile 5 x 10 cm, 2 x 4 in, Facette denim blue, relief



Wall tile 10 x 25 cm, 4 x 10 in, Facette miami mint, relief



Wall tile 10 x 25 cm, 4 x 10 in, Facette denim blue, relief



Wall tile 5 x 10 cm, 2 x 4 in, Facette racing green, relief

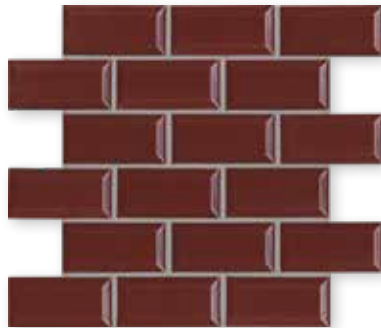

Wall tile 5 x 10 cm, 2 x 4 in, Facette burgundy red, relief



Wall tile 10 x 25 cm, 4 x 10 in, Facette racing green, relief



Wall tile 10 x 25 cm, 4 x 10 in, Facette burgundy red, relief



Mosaics glued thermoplastically on back of Agrob Buchtal can be used not only in dry zones but also without any problems in underwater areas (e.g. swimming pools/whirlpools) as well as in permanently wet areas.



Wall Tiles

5 x 10 cm<sup>1</sup>

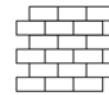

10 x 25 cm



Facette

Sheet: 316 x 316 mm

Facette



					<b>5 x 10 / 2 x 4</b>	<b>10 x 25 / 4 x 10</b>		Nom. dim. - cm/in
					50 x 102 x 6.5 mm	97 x 247 x 6.5 mm		Work size
					relief, glossy	relief, glossy		Surface
					10 sheets	40.000		m <sup>2</sup> - pieces
					16.570	19.000		m <sup>2</sup> - kg
					8 sheets	20		Bundle - pieces
					0.800	0.500		Bundle - m <sup>2</sup>
					13.256	9.500		Bundle - kg
					48.000	64.000		Pallet - m <sup>2</sup>
					795.360	1,216.000		Pallet - kg
					Blb	Blb		Product standard
					<b>45550H</b>	<b>45600H</b>		
					Price gr. <b>A169</b> (m <sup>2</sup> )	Price gr. <b>A151</b> (m <sup>2</sup> )		almond beige <input type="checkbox"/>
					<b>45551H</b>	<b>45601H</b>		
					Price gr. <b>A169</b> (m <sup>2</sup> )	Price gr. <b>A151</b> (m <sup>2</sup> )		white <input type="checkbox"/>
					<b>45552H</b>	<b>45602H</b>		
					Price gr. <b>A169</b> (m <sup>2</sup> )	Price gr. <b>A151</b> (m <sup>2</sup> )		pitch black <input type="checkbox"/>
					<b>45553H</b>	<b>45603H</b>		
					Price gr. <b>A169</b> (m <sup>2</sup> )	Price gr. <b>A151</b> (m <sup>2</sup> )		ash grey <input type="checkbox"/>
					<b>45554H</b>	<b>45604H</b>		
					Price gr. <b>A169</b> (m <sup>2</sup> )	Price gr. <b>A151</b> (m <sup>2</sup> )		miami mint <input type="checkbox"/>
					<b>45555H</b>	<b>45605H</b>		
					Price gr. <b>A169</b> (m <sup>2</sup> )	Price gr. <b>A151</b> (m <sup>2</sup> )		denim blue <input type="checkbox"/>
					<b>45556H</b>	<b>45606H</b>		
					Price gr. <b>A169</b> (m <sup>2</sup> )	Price gr. <b>A151</b> (m <sup>2</sup> )		racing green <input type="checkbox"/>
					<b>45557H</b>	<b>45607H</b>		
					Price gr. <b>A169</b> (m <sup>2</sup> )	Price gr. <b>A151</b> (m <sup>2</sup> )		burgundy red <input type="checkbox"/>



Only suitable for laying on the wall.





## Conductive floor coverings

These two specific solutions – as a stoneware tile (Eladuct) on the one hand and as a ceramic large-size panel in model size 60 x 60 cm on the other (ELA 10.6) – are suitable for use in those areas where electrostatic charge requires a conductive floor covering or where the latter is recommended. The special laying instructions must be followed carefully. We shall be delighted to advise you and to give you assistance for individual applications.

## Eladuct

Static electricity conducting stoneware tiles, unglazed



355S  
Eladuct unglazed

### Sectional Drawing

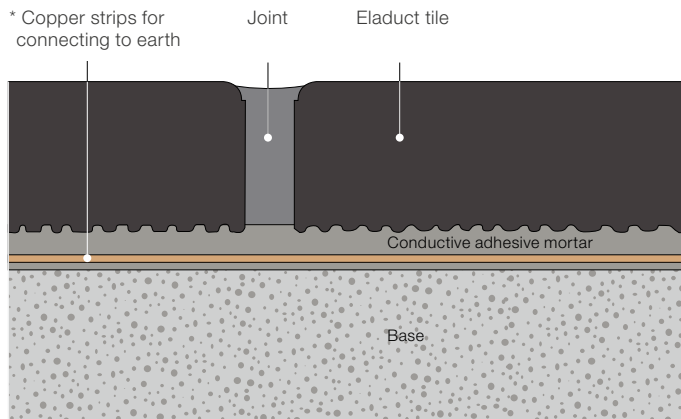

\* Number and arrangement depending on the technical requirements.  
Connection only by an electrical specialist in line with the relevant guidelines.

In the case of Eladuct, static electricity is discharged through the tile body.  
Volume resistance according to Procedure A pursuant to DIN EN 1081:  $10^8$  Ohm.



### Conductive Floor Coverings

These two specific solutions – as a stoneware tile (Eladuct) on the one hand and as a ceramic large-size panel in model size 60 x 60 cm on the other (ELA 10.6) – are suitable for use in those areas where electrostatic charge requires a conductive floor covering or where the latter is recommended. The special laying instructions must be followed carefully. We shall be delighted to advise you and to give you assistance for individual applications.

### Eladuct

is especially predestined for those areas where the discharge of static electricity is desired together with the advantages of an unglazed surface (high mechanical-chemical stress resistance).

Examples: gravure and flexographic printing areas, laboratories, rooms for lacquer production, processing and decanting, munitions dumps, chemical production plants etc.

## KerAion ELA 10.6

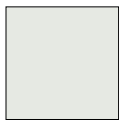

2401 RH · IV  
grey glazed  
(RH = non-slip version)

### Sectional Drawing

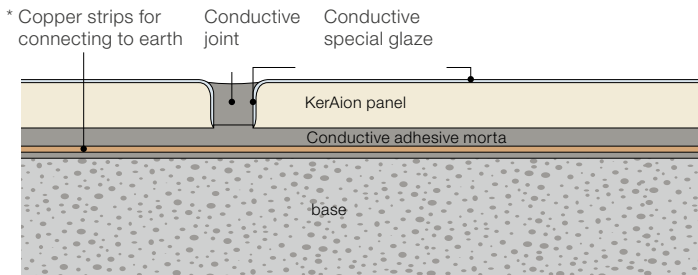

\* Number and arrangement depending on the technical requirements.  
Connection only by an electrical specialist in line with the relevant guidelines.

In the case of ELA 10.6, static electricity is discharged via the four overlaid panel edges. Surface resistance according to Procedure C pursuant to DIN EN 1081:  $10^6$  Ohm. Electrical leakage resistance  $R_A$  according to DIN EN 1081:  $10^6$  Ohm.



### KerAion ELA 10.6

is recommended for those areas where the discharge of static electricity is desired and importance is attached to the advantages of a glazed surface (e.g. very easy to clean) and a generous, representative look.

Examples: office rooms, production rooms for electronic equipment, physical measuring and work rooms, laboratories, rooms for microchip and computer manufacture, medical areas (e.g. operating theatres), telecommunication workshops, sales areas for electronic equipment etc.

Floor Tiles Skirtings

25 x 12,5 cm



25 x 8,9 cm



				Cove Skirting <i>r = 9 mm</i>	External corner <i>mitred pair</i>	Internal corner <i>mitred pair</i>	
			1110	4000	4003	4004	Model number
			<b>25 x 12.5 / 10 x 5</b>	<b>25 x 8.9 / 10 x 3 1/2</b>			Nom. dim. - <b>cm/in</b>
			240 x 115 x 20	240 x 79/9 x 11	(2x) 131 x 79/9 x 11	(2x) 115 x 79/9 x 11	Work size - <b>mm</b>
			smooth, matt	smooth, matt	smooth, matt	smooth, matt	Surface
			33.000/m <sup>2</sup>	4.000/m			<b>m<sup>2</sup>/m</b> - pieces
			53.955/m <sup>2</sup>	2.200/m	0.590/pair	0.550/pair	<b>m<sup>2</sup>/m/pair</b> - kg
			13 piece	16 piece	8 pair	8 pair	<b>Bundle</b> - pce./pair
			0.394 m <sup>2</sup>	4.000 m			<b>Bundle</b> - m <sup>2</sup> /m
			21.255	8.800	4.720	4.400	<b>Bundle</b> - kg
			23.636				<b>Pallet</b> - m <sup>2</sup>
			1,275.300				<b>Pallet</b> - kg
			Alb	Alb	Alb	Alb	Product standard
			R10				Slip resistance
			4				Stress group
			<b>355S-1110</b>	<b>355S-4000</b>	<b>355S-4003<sup>1</sup></b>	<b>355S-4004<sup>1</sup></b>	355S Eladuct
			Price gr. <b>A346</b> (m <sup>2</sup> )	Price gr. <b>A467</b> (pce.)	Price gr. <b>A528</b> (pair)	Price gr. <b>A528</b> (pair)	unglazed

In the case of Eladuct, static electricity is discharged through the tile body. Volume resistance according to Procedure A pursuant to DIN EN 1081: 10<sup>8</sup> Ohm. The 355s is defined by the contact resistance and not by the color setting. Color deviations must be accepted and are no reason for complaint.



KerAion ELA 10.6

Floor Tiles  
(static electricity conducting)

Skirtings  
(static electricity non-conducting)

60 x 60 cm



30 x 8,7 cm

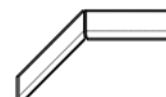

				Cove Skirting <i>r = 12 mm</i>	External corner left	External corner right	Internal corner <i>mitred pair</i>	
			K100	37040	37043	37044	37042	Model number
			<b>60 x 60 / 24 x 24</b>	<b>30 x 8.7 / 12 x 3 1/2</b>				Nom. dim. - <b>cm/in</b>
			592 x 592 x 8	292 x 79/12 x 8	280/292 x 79/12 x 8	280/292 x 79/12 x 8	(2x) 292 x 79/12 x 8	Work size - <b>mm</b>
			smooth, matt	smooth, matt	smooth, matt	smooth, matt	smooth, matt	Surface
			2.860/m <sup>2</sup>	3.333/m				<b>m<sup>2</sup>/m</b> - pieces
			18.533/m <sup>2</sup>	1.700/m	0.550/piece	0.550/piece	1.100/pair	<b>m<sup>2</sup>/m/pce./pair</b> - kg
			4 piece	32 piece	32 piece	32 piece	16 pair	<b>Bundle</b> - pce./pair
			1.399 m <sup>2</sup>	9.601 m				<b>Bundle</b> - m <sup>2</sup> /m
			25.920	16.320	17.600	17.600	17.600	<b>Bundle</b> - kg
			41.958					<b>Pallet</b> - m <sup>2</sup>
			777.600					<b>Pallet</b> - kg
			Alb	Alb	Alb	Alb	Alb	Product standard
			R9					Slip resistance
			2					Stress group
			<b>2401RH-K100-21</b>	<b>590-37040-21</b>	<b>590-37043-21</b>	<b>590-37044-21</b>	<b>590-37042-21</b>	4
			Price gr. <b>A346</b> (m <sup>2</sup> )	Price gr. <b>A445</b> (pce.)	Price gr. <b>A458</b> (pce.)	Price gr. <b>A458</b> (pce.)	Price gr. <b>A489</b> (pair)	grey glazed <input type="checkbox"/> V0
								grey glazed <input type="checkbox"/> V0

In the case of KerAion ELA 10.6, static electricity is discharged via the four overglazed panel edges. Surface resistance according to Procedure C pursuant to DIN EN 1081: 10<sup>9</sup> Ohm.







## Modular and timeless

With colors and surfaces matched to one another, slip-resistant tiles from R9 to R12V4 and formats from 30 x 30 cm to 60 x 60 cm, the tiles of the Emotion series offer architects a great deal of freedom. Emotion ensures good design particularly in areas where transitions between different slip-resistance requirements are needed. This makes front cooking in direct view of restaurant guests just as feasible as the seamless and aesthetically pleasing combination of workshop and showroom in a car dealership.

Studio photo / Architect: Sylvia Leydecker / Photo: Jochen Stüber



R9 R10/A R11/B



### Surfaces: Floor tiles

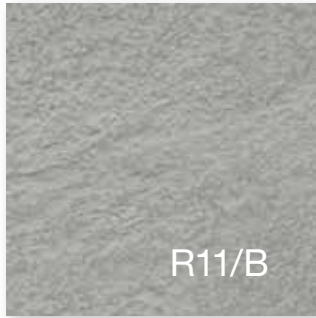
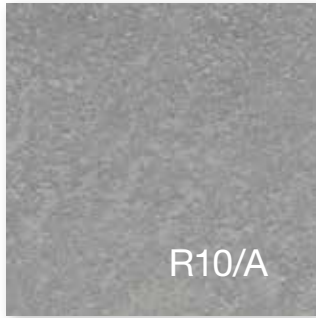
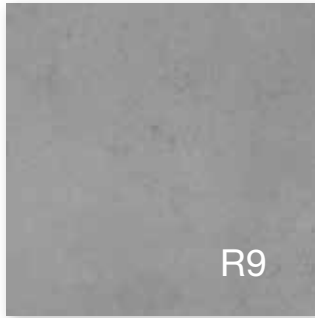

basalt



light-beige



deep anthracite

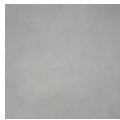

mid-grey



Floor tile 30 x 30 cm, 12 x 12 in structured, R10/A



Floor tile 30 x 30 cm, 12 x 12 in relief, R11/B



Floor tile 30 x 60 cm, 12 x 24 in, smooth, R9  
Floor tile 30 x 60 cm, 12 x 24 in, structured, R10/A  
Floor tile 30 x 60 cm, 12 x 24 in, relief, R11/B





Floor tile 60 x 60 cm, 24 x 24 in, smooth, R9  
Floor tile 60 x 60 cm, 24 x 24 in, structured, R10/A



Stair tile 30 x 60 cm (with grooves), 12 x 24 in, smooth, R9  
Stair tile 30 x 60 cm (with grooves), 12 x 24 in, structured, R10/A



Skirting, rounded 7 x 60 cm, 2 13/16 x 24 in, smooth  
Skirting, rounded 7 x 60 cm, 2 13/16 x 24 in, structured

Ceramic channel cover  
Corner solution 30 x 30 cm, 12 x 12 in

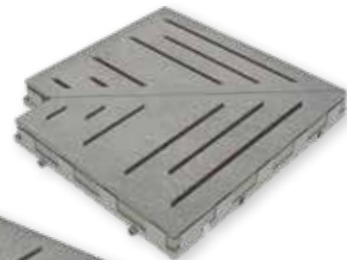

Ceramic channel cover  
25 x 50 cm, 10 x 20 in



For details about the Ceramic channel cover, refer to the Pool + Spa programme of delivery.

Floor Tiles<sup>1</sup>

30 x 30 cm



30 x 30 cm



30 x 60 cm

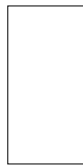

30 x 60 cm



30 x 60 cm



60 x 60 cm

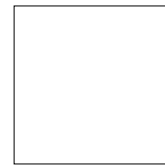

60 x 60 cm

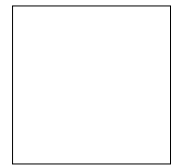

protected

Nom. dim. - cm/in	30 x 30 / 12 x 12	30 x 30 / 12 x 12	30 x 60 / 12 x 24	30 x 60 / 12 x 24	30 x 60 / 12 x 24	60 x 60 / 24 x 24	60 x 60 / 24 x 24
Work size	297 x 297 x 10.5 mm	297 x 297 x 10.5 mm	297 x 597 x 10.5 mm	297 x 597 x 10.5 mm	297 x 597 x 10.5 mm	597 x 597 x 10.5 mm	597 x 597 x 10.5 mm
Surface	structured, matt	relief, matt	smooth, matt	structured, matt	relief, matt	smooth, matt	structured, matt
m <sup>2</sup> - pieces	11.110	11.110	5.556	5.556	5.556	2.778	2.778
m <sup>2</sup> - kg	23.142	23.142	23.224	23.224	23.224	23.769	23.769
Bundle - pieces	11	11	6	6	6	3	3
Bundle - m <sup>2</sup>	0.990	0.990	1.080	1.080	1.080	1.080	1.080
Bundle - kg	22.913	22.913	25.080	25.080	25.080	25.668	25.668
Pallet - m <sup>2</sup>	47.525	47.525	43.197	43.197	43.197	38.877	38.877
Pallet - kg	1,099.824	1,099.824	1,003.200	1,003.200	1,003.200	924.048	924.048
Product standard	Bla	Bla	Bla	Bla	Bla	Bla	Bla
Slip resistance	R10/A	R11/B	R9	R10/A	R11/B	R9	R10/A
Stress group	3	3	2	2	2	3	3
deep anthracite	<b>433730</b> Price gr. <b>A70</b> (m <sup>2</sup> )	<b>433733</b> Price gr. <b>A70</b> (m <sup>2</sup> )	<b>433402</b> Price gr. <b>A97</b> (m <sup>2</sup> )	<b>433406</b> Price gr. <b>A109</b> (m <sup>2</sup> )	<b>433410</b> Price gr. <b>A109</b> (m <sup>2</sup> )	<b>433660</b> Price gr. <b>A124</b> (m <sup>2</sup> )	<b>433664</b> Price gr. <b>A124</b> (m <sup>2</sup> )
light-beige	<b>433732</b> Price gr. <b>A70</b> (m <sup>2</sup> )	<b>433735</b> Price gr. <b>A70</b> (m <sup>2</sup> )	<b>433404</b> Price gr. <b>A97</b> (m <sup>2</sup> )	<b>433408</b> Price gr. <b>A109</b> (m <sup>2</sup> )	<b>433412</b> Price gr. <b>A109</b> (m <sup>2</sup> )	<b>433662</b> Price gr. <b>A124</b> (m <sup>2</sup> )	<b>433666</b> Price gr. <b>A124</b> (m <sup>2</sup> )
medium grey	<b>433731</b> Price gr. <b>A70</b> (m <sup>2</sup> )	<b>433734</b> Price gr. <b>A70</b> (m <sup>2</sup> )	<b>433403</b> Price gr. <b>A97</b> (m <sup>2</sup> )	<b>433407</b> Price gr. <b>A109</b> (m <sup>2</sup> )	<b>433411</b> Price gr. <b>A109</b> (m <sup>2</sup> )	<b>433661</b> Price gr. <b>A124</b> (m <sup>2</sup> )	<b>433665</b> Price gr. <b>A124</b> (m <sup>2</sup> )
basalt	<b>433440</b> Price gr. <b>A70</b> (m <sup>2</sup> )	<b>433442</b> Price gr. <b>A70</b> (m <sup>2</sup> )	<b>433430</b> Price gr. <b>A97</b> (m <sup>2</sup> )	<b>433432</b> Price gr. <b>A109</b> (m <sup>2</sup> )	<b>433434</b> Price gr. <b>A109</b> (m <sup>2</sup> )	<b>433436</b> Price gr. <b>A124</b> (m <sup>2</sup> )	<b>433438</b> Price gr. <b>A124</b> (m <sup>2</sup> )



Stair Tiles<sup>1/2</sup>

30 x 60 cm

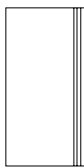

30 x 60 cm



7 x 60 cm



7 x 60 cm



15 x 60 cm



15 x 15 cm



protected

Nom. dim. - cm/in	30 x 60 / 12 x 24	30 x 60 / 12 x 24	7 x 60 / 2 13/16 x 24	7 x 60 / 2 13/16 x 24	15 x 60 / 6 x 24	15 x 15 / 6 x 6
Work size	297 x 597 x 10.5 mm	297 x 597 x 10.5 mm	70 x 597 x 10.5 mm	70 x 597 x 10.5 mm	158 x 597 x 10.5 mm	158 x 158 x 10.5 mm
Surface	smooth, matt	structured, matt	smooth, matt	structured, matt	structured, matt	structured, matt
m - pieces	1.667	1.667	1.667	1.667	1.667	
m - kg	6.968	6.968	1.717	1.717	4.334	
Bundle - pieces	6	6	22	22	4	4
Bundle - m	3.599	3.599	13.197	13.197	2.399	
Bundle - kg	25.080	25.080	22.660	22.660	10.400	6.000
Pallet - m						
Pallet - kg						
Product standard	Bla	Bla	Bla	Bla	Bla	Bla
Slip resistance	R9	R10/A			R10/A	R10/A
Stress group	2	2				
deep anthracite	<b>433850</b> Price gr. <b>A475</b> (pce.)	<b>433854</b> Price gr. <b>A475</b> (pce.)	<b>433802</b> Price gr. <b>A434</b> (m <sup>2</sup> )	<b>433806</b> Price gr. <b>A434</b> (m <sup>2</sup> )		
light-beige	<b>433852</b> Price gr. <b>A475</b> (pce.)	<b>433856</b> Price gr. <b>A475</b> (pce.)	<b>433804</b> Price gr. <b>A434</b> (m <sup>2</sup> )	<b>433808</b> Price gr. <b>A434</b> (m <sup>2</sup> )	<b>432805-HKS</b> Price gr. <b>A573</b> (pce.)	<b>432805-IE</b> Price gr. <b>A601</b> (pce.)
mid-grey	<b>433851</b> Price gr. <b>A475</b> (pce.)	<b>433855</b> Price gr. <b>A475</b> (pce.)	<b>433803</b> Price gr. <b>A434</b> (m <sup>2</sup> )	<b>433807</b> Price gr. <b>A434</b> (m <sup>2</sup> )		
basalt	<b>433817</b> Price gr. <b>A475</b> (pce.)	<b>433819</b> Price gr. <b>A475</b> (pce.)	<b>433821</b> Price gr. <b>A434</b> (m <sup>2</sup> )	<b>433823</b> Price gr. <b>A434</b> (m <sup>2</sup> )		



<sup>3</sup> Minimum order quantity 50 pieces

<sup>4</sup> Other colors available on request

<sup>5</sup> For detail drawings of cove skirting and internal corner, refer to page 536

You will find other cove skirtings on page 201 under the series Emotion Grip. Attention: Color deviation from the rest of the Emotion range, as fine-grain look.



KUBEZ (cultural and meeting centre), Dietach, Austria / Architect: Team M Architekten ZT GesmbH / Photo: Roland Reuter, Absam







R10/A R11/B R11V4 R12 R12V4 R12V8 R13 R13V10



Surfaces: Floor tiles



basalt

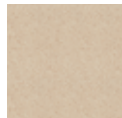

light-beige



deep anthracite

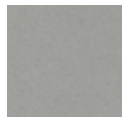

mid-grey

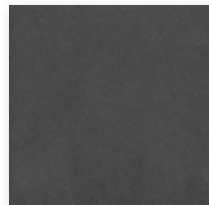

Floor tile 20 x 20 cm, 8 x 8 in, smooth, R10/A  
 Floor tile 20 x 20 cm, 8 x 8 in, Softcorn 2, R11/B  
 Floor tile 20 x 20 cm, 8 x 8 in, Perlicorn 2, R11V4  
 Floor tile 20 x 20 cm, 8 x 8 in, Perlstic, R12  
 Floor tile 20 x 20 cm, 8 x 8 in, Carostic, R12V4  
 Floor tile 20 x 20 cm, 8 x 8 in, Picstic, R12V8, extra thick  
 Floor tile 20 x 20 cm, 8 x 8 in, roughened, R13, extra thick  
 Floor tile 20 x 20 cm, 8 x 8 in, Kombicorn, R13V10, extra thick



Floor tile 30 x 30 cm, 12 x 12 in, smooth, R10/A



Stair tile 30 x 30 cm (with grooves), 12 x 12 in, smooth, R10/A

Mosaic

10 x 10 cm, 4 x 4 in

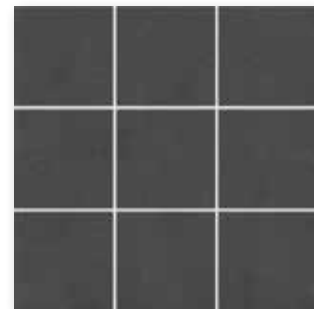

Mosaic sheet 30 x 30 cm, 12 x 12 in, smooth, R10/B



Mosaics glued thermoplastically on back of Agrob Buchtal can be used not only in dry zones but also without any problems in underwater areas (e.g. swimming pools/whirlpools) as well as in permanently wet areas (e.g. pool surrounds/showers).

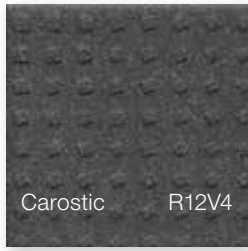

Carostic R12V4

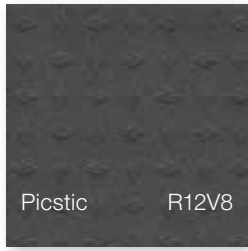

Picstic R12V8



roughened R13



Kombicorn R13V10



Skirting with bevel 10 x 20 cm, 4 x 8 in smooth



Cove skirting 10 x 20 cm, 4 x 8 in, smooth, R10/A



Cove skirting 10 x 30 cm, 4 x 12 in, smooth, R10/A



Internal corner for cove skirting, smooth



External corner for cove skirting, smooth



yellow



black



Safety triangles, extra thick 27.8 x 20 cm, 11 x 8 in, grained, R11



Laying pattern

Mosaic<sup>1</sup>

Wall/Floor Tiles

10 x 10 cm

20 x 20 cm

20 x 20 cm

20 x 20 cm

20 x 20 cm

20 x 20 cm



protected

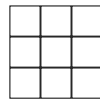

Sheet: 297 x 297 mm

smooth

Softcorn 2

Perlcom 2

Perlstic

Carostic

Nom. dim. - cm/in	10 x 10 / 4 x 4	20 x 20 / 8 x 8	20 x 20 / 8 x 8	20 x 20 / 8 x 8	20 x 20 / 8 x 8	20 x 20 / 8 x 8	20 x 20 / 8 x 8
Work size	97 x 97 x 6.5 mm	197 x 197 x 10.5 mm	197 x 197 x 10.5 mm	197 x 197 x 10.5 mm	197 x 197 x 10.5 mm	197 x 197 x 10.5 mm	197 x 197 x 10.5 mm
Surface	smooth, matt	smooth, matt	structured, matt	fine-grained, matt	fine-grained, matt	fine-grained, matt	profiled, matt
m <sup>2</sup> - pieces	11 sheets	25.000	25.000	25.000	25.000	25.000	25.000
m <sup>2</sup> - kg	13.101	22.900	22.900	22.900	22.900	22.900	22.900
Bundle - pieces	11 sheets	21	21	21	21	21	21
Bundle - m <sup>2</sup>	1.000	0.840	0.840	0.840	0.840	0.840	0.840
Bundle - kg	13.101	19.236	19.236	19.236	19.236	19.236	19.236
Pallet - m <sup>2</sup>	64.000	50.400	50.400	50.400	50.400	50.400	50.400
Pallet - kg	838.464	1,154.160	1,154.160	1,154.160	1,154.160	1,154.160	1,154.160
Product standard	Bla	Bla	Bla	Bla	Bla	Bla	Bla
Slip resistance	R10/B	R10/A	R11/B	R11V4	R12	R12V4	R12V4
Stress group	1	3	3	3	3	3	3
deep anthracite <input type="checkbox"/>	<b>435026</b> Price gr. <b>A148</b> (m <sup>2</sup> )	<b>434216</b> Price gr. <b>A121</b> (m <sup>2</sup> )	<b>434219</b> Price gr. <b>A121</b> (m <sup>2</sup> )	<b>434222</b> Price gr. <b>A154</b> (m <sup>2</sup> )	<b>434225</b> Price gr. <b>A154</b> (m <sup>2</sup> )	<b>434228</b> Price gr. <b>A154</b> (m <sup>2</sup> )	
medium grey <input type="checkbox"/>	<b>435027</b> Price gr. <b>A148</b> (m <sup>2</sup> )	<b>434217</b> Price gr. <b>A121</b> (m <sup>2</sup> )	<b>434220</b> Price gr. <b>A121</b> (m <sup>2</sup> )	<b>434223</b> Price gr. <b>A154</b> (m <sup>2</sup> )	<b>434226</b> Price gr. <b>A154</b> (m <sup>2</sup> )	<b>434229</b> Price gr. <b>A154</b> (m <sup>2</sup> )	
light-beige <input type="checkbox"/>	<b>435028</b> Price gr. <b>A148</b> (m <sup>2</sup> )	<b>434218</b> Price gr. <b>A121</b> (m <sup>2</sup> )	<b>434221</b> Price gr. <b>A121</b> (m <sup>2</sup> )	<b>434224</b> Price gr. <b>A154</b> (m <sup>2</sup> )	<b>434227</b> Price gr. <b>A154</b> (m <sup>2</sup> )	<b>434230</b> Price gr. <b>A154</b> (m <sup>2</sup> )	
basalt <input type="checkbox"/>	<b>435029</b> Price gr. <b>A148</b> (m <sup>2</sup> )	<b>434326</b> Price gr. <b>A121</b> (m <sup>2</sup> )	<b>434328</b> Price gr. <b>A121</b> (m <sup>2</sup> )	<b>434330</b> Price gr. <b>A154</b> (m <sup>2</sup> )	<b>434332</b> Price gr. <b>A154</b> (m <sup>2</sup> )	<b>434334</b> Price gr. <b>A154</b> (m <sup>2</sup> )	



Wall/Floor Tiles

Floor Tiles<sup>2</sup>

30 x 30 cm

20 x 20 cm

20 x 20 cm

20 x 20 cm

20 x 20 cm

20 x 20 cm

20 x 20 cm



protected



smooth

smooth, extra thick

Softcorn 2, extra thick

Perlstic, extra thick

Carostic, extra thick

Picstic, extra thick

Roughened, extra thick

Nom. dim. - cm/in	30 x 30 / 12 x 12	20 x 20 / 8 x 8	20 x 20 / 8 x 8	20 x 20 / 8 x 8	20 x 20 / 8 x 8	20 x 20 / 8 x 8	20 x 20 / 8 x 8
Work size	297 x 297 x 10.5 mm	197 x 197 x 15 mm	197 x 197 x 15 mm	197 x 197 x 15 mm	197 x 197 x 15 mm	197 x 197 x 15 mm	197 x 197 x 15 mm
Surface	smooth, matt	smooth, matt	structured, matt	fine-grained, matt	fine-grained, matt	smooth, matt	profiled, matt
m <sup>2</sup> /m - pieces	11.111/m <sup>2</sup>	25.767/m <sup>2</sup>	25.767/m <sup>2</sup>	25.767/m <sup>2</sup>	25.767/m <sup>2</sup>	25.767/m <sup>2</sup>	25.767/m <sup>2</sup>
m <sup>2</sup> /m - kg	23.144/m <sup>2</sup>	34.322/m <sup>2</sup>	34.322/m <sup>2</sup>	34.322/m <sup>2</sup>	34.322/m <sup>2</sup>	34.322/m <sup>2</sup>	34.322/m <sup>2</sup>
Bundle - pieces	11	15	15	15	15	15	15
Bundle - m <sup>2</sup> /m	0.990 m <sup>2</sup>	0.582 m <sup>2</sup>	0.582 m <sup>2</sup>	0.582 m <sup>2</sup>	0.582 m <sup>2</sup>	0.582 m <sup>2</sup>	0.582 m <sup>2</sup>
Bundle - kg	22.913	19.980	19.980	19.980	19.980	19.980	19.980
Pallet - m <sup>2</sup>	47.520	34.928	34.928	34.928	34.928	34.928	34.928
Pallet - kg	1,099.824	1,198.800	1,198.800	1,198.800	1,198.800	1,198.800	1,198.800
Product standard	Bla	Bla	Bla	Bla	Bla	Bla	Bla
Slip resistance	R10/A	R10/A	R11/B	R12	R12V4	R12V8	R13
Stress group	3	4	4	4	4	4	4
deep anthracite <input type="checkbox"/>	<b>434239</b> Price gr. <b>A100</b> (m <sup>2</sup> )	<b>434231</b> Price gr. <b>A154</b> (m <sup>2</sup> )	<b>434233</b> Price gr. <b>A154</b> (m <sup>2</sup> )	<b>434235</b> Price gr. <b>A166</b> (m <sup>2</sup> )	<b>434237</b> Price gr. <b>A166</b> (m <sup>2</sup> )	<b>434976</b> Price gr. <b>A181</b> (m <sup>2</sup> )	<b>434978</b> Price gr. <b>A181</b> (m <sup>2</sup> )
medium grey <input type="checkbox"/>	<b>434240</b> Price gr. <b>A100</b> (m <sup>2</sup> )	<b>434232</b> Price gr. <b>A154</b> (m <sup>2</sup> )	<b>434234</b> Price gr. <b>A154</b> (m <sup>2</sup> )	<b>434236</b> Price gr. <b>A166</b> (m <sup>2</sup> )	<b>434238</b> Price gr. <b>A166</b> (m <sup>2</sup> )	<b>434977</b> Price gr. <b>A181</b> (m <sup>2</sup> )	<b>434979</b> Price gr. <b>A181</b> (m <sup>2</sup> )
light-beige <input type="checkbox"/>	<b>434241</b> Price gr. <b>A100</b> (m <sup>2</sup> )						
basalt <input type="checkbox"/>	<b>434336</b> Price gr. <b>A100</b> (m <sup>2</sup> )						



<sup>2</sup> Delivery time on request



Skirting with Bevel Stair Tiles

20 x 20 cm<sup>3</sup>



*Kombicorn, extra thick*

27,8 x 20 cm<sup>2</sup>



*Safety triangles, extra thick*

10 x 20 cm



Bla

30 x 30 cm<sup>1</sup>

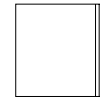

Bla



			<b>20 x 20 / 8 x 8</b>	<b>27,8 x 20 / 11 x 8</b>	<b>10 x 20 / 4 x 8</b>	<b>30 x 30 / 12 x 12</b>	Nom. dim. - <b>cm/in</b>	
			197 x 197 x 15 mm	278 x 197/197 x 15 mm	97 x 197 x 10.5 mm	297 x 297 x 10.5 mm	Work size	
			profiled, matt	fine-grained, matt	smooth, matt	smooth, matt	Surface	
			25.767/m <sup>2</sup>	3.597/1.798/m	5.000/m	3.333/m	m <sup>2</sup> / <b>m</b> - pieces	
			34.322/m <sup>2</sup>	2.374/1.187/m	2.250/m	6.943/m	m <sup>2</sup> / <b>m/pce.</b> - kg	
			15	28	20	10	<b>Bundle</b> - pieces	
			0.582 m <sup>2</sup>	7.784/15.573 m	4.000 m	3.003 m	<b>Bundle</b> - m/m <sup>2</sup>	
			19.980	18.480	9.000	20.830	<b>Bundle</b> - kg	
			34.928				<b>Pallet</b> - m <sup>2</sup>	
			1,198.800				<b>Pallet</b> - kg	
			Bla	Bla	Bla	Bla	Product standard	
			R13V10	R11			Slip resistance	
			4	4		3	Stress group	
			<b>434980</b>		<b>434248</b>	<b>434251</b>	deep anthracite	<input type="checkbox"/>
			Price gr. <b>A181</b> (m <sup>2</sup> )		Price gr. <b>A416</b> (pce.)	Price gr. <b>A449</b> (pce.)		
			<b>434981</b>		<b>434249</b>	<b>434252</b>	medium grey	<input type="checkbox"/>
			Price gr. <b>A181</b> (m <sup>2</sup> )		Price gr. <b>A416</b> (pce.)	Price gr. <b>A449</b> (pce.)		
					<b>434250</b>	<b>434253</b>	light-beige	<input type="checkbox"/>
					Price gr. <b>A416</b> (pce.)	Price gr. <b>A449</b> (pce.)		
					<b>434342</b>	<b>434344</b>	basalt	<input type="checkbox"/>
					Price gr. <b>A416</b> (pce.)	Price gr. <b>A449</b> (pce.)		
				<b>431321</b>			yellow	<input type="checkbox"/>
				Price gr. <b>A416</b> (pce.)				
				<b>431320</b>			black	<input type="checkbox"/>
				Price gr. <b>A416</b> (pce.)				



Cove Skirting<sup>4/6</sup>

10 x 20 cm



10 x 30 cm



Internal Corner for Cove Skirting<sup>4/5</sup>



External Corner for Cove Skirting<sup>4/5</sup>



			<b>10 x 20 / 4 x 8</b>	<b>10 x 30 / 4 x 12</b>			Nom. dim. - <b>cm/in</b>	
			102 x 197 x 9 mm	102 x 297 x 9 mm	102 x 20 x 9 mm	102 x 35 x 9 mm	Work size	
			smooth, matt	smooth, matt	smooth, matt	smooth, matt	Surface	
			5.000	3.333			<b>m</b> - pieces	
			2.000/m	2.000/m	0.080/piece	0.080/piece	<b>m/pce.</b> - kg	
			20	16	18	12	<b>Bundle</b> - pieces	
			4.000	4.801			<b>Bundle</b> - m	
			8.000	9.600			<b>Bundle</b> - kg	
							<b>Pallet</b> - m	
							<b>Pallet</b> - kg	
			Bla	Bla	Bla	Bla	Product standard	
			R10/A	R10/A			Slip resistance	
			<b>432027</b>	<b>432033</b>	<b>432039</b>	<b>432045</b>	deep anthracite	<input type="checkbox"/>
			Price gr. <b>A419</b> (pce.)	Price gr. <b>A425</b> (pce.)	Price gr. <b>A418</b> (pce.)	Price gr. <b>A418</b> (pce.)		
			<b>432028</b>	<b>432034</b>	<b>432040</b>	<b>432046</b>	medium grey	<input type="checkbox"/>
			Price gr. <b>A419</b> (pce.)	Price gr. <b>A425</b> (pce.)	Price gr. <b>A418</b> (pce.)	Price gr. <b>A418</b> (pce.)		
			<b>432029</b>	<b>432035</b>	<b>432041</b>	<b>432047</b>	light-beige	<input type="checkbox"/>
			Price gr. <b>A419</b> (pce.)	Price gr. <b>A425</b> (pce.)	Price gr. <b>A418</b> (pce.)	Price gr. <b>A418</b> (pce.)		
			<b>432030</b>	<b>432036</b>	<b>432042</b>	<b>432048</b>	basalt	<input type="checkbox"/>
			Price gr. <b>A419</b> (pce.)	Price gr. <b>A425</b> (pce.)	Price gr. <b>A418</b> (pce.)	Price gr. <b>A418</b> (pce.)		



<sup>2</sup> Specification of the logistical data for single-row or double-row installation

<sup>3</sup> Delivery time on request

<sup>4</sup> For details, refer to page 536

<sup>5</sup> Fitting to cove skirting 10 x 20 / 10 x 30 cm

<sup>6</sup> Color deviations compared to the adjoining covering due to production are no reason for complaint in case of horizontal laying.





## Luxurious and harmonious

Whether in combination with natural materials, pastel colors or metal: Evalia adapts to individual home ideas and adds a tasteful, luxurious touch. The large-format R9 floor tiles in grey, beige and anthracite harmonize with the wall tiles in grey beige matt or glossy. Likewise in grey-beige: the Shino decorative element measuring 30 x 60 cm and the R10/B mosaic in 5 x 5 cm whose similar look and feel inject some dynamism into the design. Wall tiles, decorations and mosaics are easy to clean thanks to the Hytect surface. The range of tiles is rounded off by skirtings.

Rendering

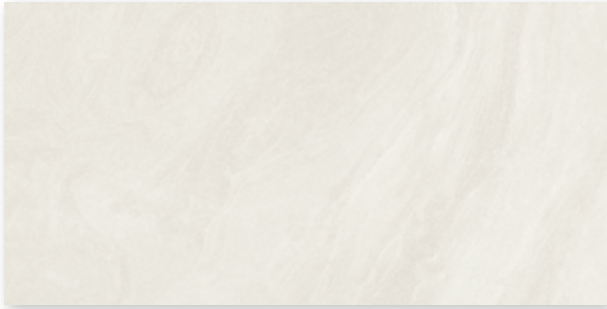

Wall tile 30 x 60 cm, 12 x 24 in, grey beige, smooth

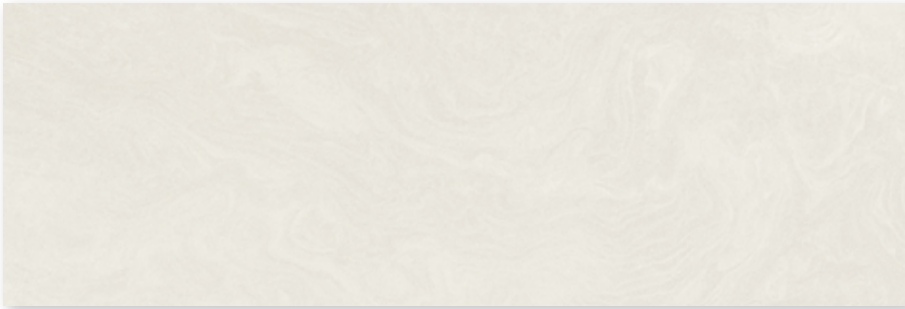

Wall tile 30 x 90 cm, 12 x 36 in, grey beige, smooth

## Decoration Elements



Decorative tile Shino 30 x 60 cm, 12 x 24 in, grey beige, smooth

## Decoration Elements



Decorative tile Shino 30 x 90 cm, 12 x 36 in, grey beige, smooth

Color deviations are possible and represent a component of the design. The decoration you have chosen is a high-quality glazed earthenware product with a particularly impressive and realistic stone look. The decoration comprises various individual pictures, whose connections are consciously freely designed. Accordingly, individual tiles do not create a continuous design.



grey

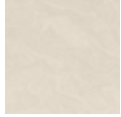

beige



anthracite



Floor tile 60 x 60 cm, 24 x 24 in, smooth, R9



Skirting, rounded 7 x 60 cm, 2 13/16 x 24 in, smooth

### Mosaic 5 x 5 cm, 2 x 2 in



Mosaic sheet Shino 30 x 30 cm, 12 x 12 in  
grey beige, smooth, R10/B



Mosaics glued thermoplastically on back of Agrob Buchtal can be used not only in dry zones but also without any problems in underwater areas (e.g. swimming pools/whirlpools) as well as in permanently wet areas (e.g. pool surrounds/showers).

### Wall Tiles

30 x 60 cm<sup>1</sup>



30 x 60 cm<sup>1</sup>



30 x 90 cm<sup>2</sup>

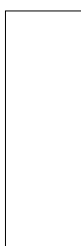

30 x 90 cm<sup>2</sup>



### Decoration Elements<sup>4/5</sup>

30 x 60 cm<sup>1</sup>

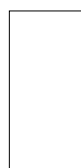

30 x 90 cm<sup>2</sup>



	30 x 60 / 12 x 24	30 x 60 / 12 x 24	30 x 90 / 12 x 36	30 x 90 / 12 x 36	Shino 30 x 60 / 12 x 24	Shino 30 x 90 / 12 x 36	
	297 x 597 x 9 mm	297 x 597 x 9 mm	297 x 897 x 10.5 mm	297 x 897 x 10.5 mm	297 x 597 x 9 mm	297 x 897 x 10.5 mm	Nom. dim. - cm/in
	smooth, glossy	smooth, silky-matt	smooth, glossy	smooth, silky-matt	smooth, glossy	smooth, glossy	Work size
	5.556	5.556	3.704	3.704	5.556	3.704	Surface
	15.279	15.279	17.976	17.976	15.279	17.976	m <sup>2</sup> - pieces
	9	9	5	5	9	5	m <sup>2</sup> - kg
	1.620	1.620	1.350	1.350	1.620	1.350	Bundle - pieces
	24.750	24.750	24.265	24.265	24.750	24.265	Bundle - m <sup>2</sup>
	77.754	77.754	32.397	32.397	77.754	32.397	Bundle - kg
	1,188.000	1,188.000	582.360	582.360	1,188.000	582.360	Pallet - m <sup>2</sup>
	BIII	BIII	BIII	BIII	BIII	BIII	Pallet - kg
	<b>283102HR</b>	<b>283126HR</b>	<b>393104H</b>	<b>393127H</b>			Product standard
	Price gr. C122 (m <sup>2</sup> )	Price gr. C122 (m <sup>2</sup> )	Price gr. C149 (m <sup>2</sup> )	Price gr. C149 (m <sup>2</sup> )			grey beige <span style="border: 1px solid black; padding: 0 2px;">V2</span>
					<b>283103HR</b>	<b>393105H</b>	grey beige <span style="border: 1px solid black; padding: 0 2px;">V4</span>
					Price gr. C128 (m <sup>2</sup> )	Price gr. C155 (m <sup>2</sup> )	

### Mosaic<sup>3/6</sup>

5 x 5 cm



### Floor Tiles<sup>1</sup>

60 x 60 cm

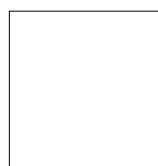

### Skirting, rounded<sup>1</sup>

7 x 60 cm



protected

				Shino Sheet: 297 x 297 mm	5 x 5 / 2 x 2	60 x 60 / 24 x 24	7 x 60 / 2 13/16 x 24	
					47 x 47 x 6.5 mm	595 x 595 x 9.5 mm	70 x 595 x 9.5 mm	Nom. dim. - cm/in
					smooth, matt	smooth, semi-polished	smooth, semi-polished	Work size
					11 sheets	2.778/m <sup>2</sup>	1.667/m	Surface
					12.331/m <sup>2</sup>	21.112/m <sup>2</sup>	1.470/m	m <sup>2</sup> - pieces
					11 sheets	4	15	m <sup>2</sup> - kg
					1.000 m <sup>2</sup>	1.440 m <sup>2</sup>	8.998 m	Bundle - pieces
					12.331	30.400	13.230	Bundle - m <sup>2</sup>
					64.000	46.076		Bundle - kg
					789.184	972.800		Pallet - m <sup>2</sup>
					Bla	Bla	Bla	Pallet - kg
					R10/B	R9		Product standard
					1	2		Slip resistance
					<b>431919H</b>			Stress group
					Price gr. C230 (m <sup>2</sup> )			grey beige <span style="border: 1px solid black; padding: 0 2px;">V4</span>
						<b>431913</b>	<b>431920</b>	grey <span style="border: 1px solid black; padding: 0 2px;">V3</span>
						Price gr. C155 (m <sup>2</sup> )	Price gr. C440 (pce.)	
						<b>431914</b>	<b>431921</b>	beige <span style="border: 1px solid black; padding: 0 2px;">V3</span>
						Price gr. C155 (m <sup>2</sup> )	Price gr. C440 (pce.)	
						<b>431915</b>	<b>431922</b>	anthracite <span style="border: 1px solid black; padding: 0 2px;">V3</span>
						Price gr. C155 (m <sup>2</sup> )	Price gr. C440 (pce.)	

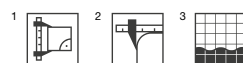

<sup>4</sup> The decoration consists of different individual pictures. The connections of the individual pictures are deliberately designed freely and thus do not connect in the continuous laying. The composition of the motifs in the box may vary due to production reasons.

<sup>5</sup> Decoration elements only available in full boxes.

<sup>6</sup> without Protecta upgrading; with Hytect coating







## Authentic surface

The Factory series ceramically transforms lived-in concrete floors into a lively and uncomplicated covering. In combination with classic ornamental accents, the result is a series which combines the style worlds of Industrial & Modern Country in a cosy way. Color shades from both worlds round off the concept and cater to individual design preferences. Factory also includes Circle, a versatile decorative element for walls and floors, which sets accents without appearing fashionable or dominant. All products are Hytect-coated and therefore particularly easy to clean.

Rendering

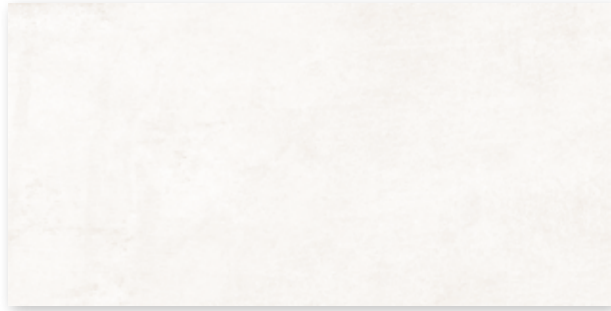

Wall tile 30 x 60 cm, 12 x 24 in, cotton, structured



Wall tile 30 x 60 cm, 12 x 24 in, smoke white, structured

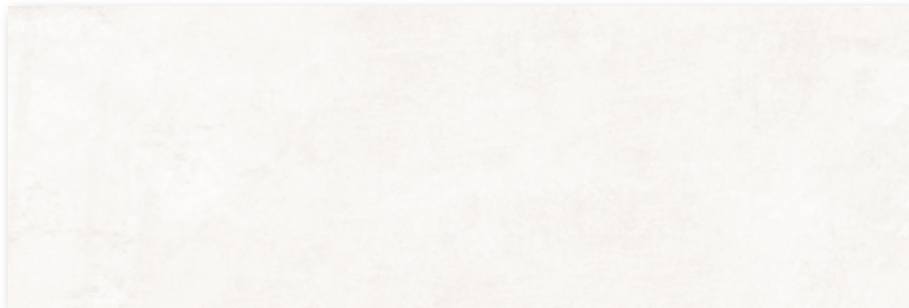

Wall tile 30 x 90 cm, 12 x 36 in, cotton, structured



Wall tile 30 x 90 cm, 12 x 36 in, smoke white, structured

## Decoration Elements

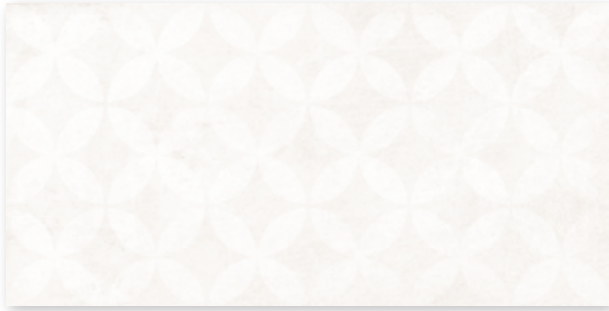

Decorative tile Circle 30 x 60 cm, 12 x 24 in, cotton, structured



Decorative tile Circle 30 x 60 cm, 12 x 24 in, smoke white, structured



Decorative tile Circle 30 x 90 cm, cotton, structured



Decorative tile Circle 30 x 90 cm, smoke white, structured



lime

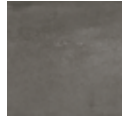

bronze grey



aluminium



asphalt



blue steel



Floor tile 30 x 60 cm, 12 x 24 in, structured, R10/A+B



Floor tile 60 x 60 cm, 24 x 24 in, structured, R10/A+B



Floor tile 60 x 120 cm, 24 x 48 in, structured, R10/A+B

## Mosaic

5 x 5 cm, 2 x 2 in



Mosaic sheet 30 x 30 cm, 12 x 12 in, structured, R10/A+B

Mosaic: Glass fibre net on reverse side, sheet: 297 x 297 mm

## Decoration Elements



Floor decor Circle 60 x 60 cm, 24 x 24 in, structured, R10/A+B



Patio tile 60 x 60 cm, 24 x 24 in, structured, R11/B



Skirting, rounded 7 x 60 cm, 2 13/16 x 24 in, structured



Stair tile 30 x 120 cm, 12 x 48 in, (with grooves), structured, R10/A+B

Wall Tiles

Decoration Elements<sup>2</sup>

30 x 60 cm



30 x 90 cm<sup>1</sup>

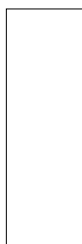

30 x 60 cm



30 x 90 cm<sup>1</sup>



Circle

Circle

Nom. dim. - cm/in	<b>30 x 60 / 12 x 24</b>	<b>30 x 90 / 12 x 36</b>	<b>30 x 60 / 12 x 24</b>	<b>30 x 90 / 12 x 36</b>			
Work size	297 x 597 x 6 mm	297 x 897 x 6 mm	297 x 597 x 6 mm	297 x 897 x 6 mm			
Surface	structured, stone-matt	structured, stone-matt	structured, stone-matt	structured, stone-matt			
m <sup>2</sup> - pieces	5.556	3.704	5.556	3.704			
m <sup>2</sup> - kg	10.279	10.400	10.279	10.400			
Bundle - pieces	13	8	13	8			
Bundle - m <sup>2</sup>	2.340	2.160	2.340	2.160			
Bundle - kg	24.050	22.464	24.050	22.464			
Pallet - m <sup>2</sup>	112.311	51.836	112.311	51.836			
Pallet - kg	1,154.400	539.136	1,154.400	539.136			
Product standard	BIII	BIII	BIII	BIII			
	<b>203479H</b>	<b>323485H</b>	<b>203481H</b>	<b>323483H</b>			
cotton <span style="border: 1px solid black; padding: 0 2px;">V2</span>	Price gr. <b>C107</b> (m <sup>2</sup> )	Price gr. <b>C149</b> (m <sup>2</sup> )	Price gr. <b>C116</b> (m <sup>2</sup> )	Price gr. <b>C155</b> (m <sup>2</sup> )			
	<b>203480H</b>	<b>323486H</b>	<b>203482H</b>	<b>323484H</b>			
smoke white <span style="border: 1px solid black; padding: 0 2px;">V2</span>	Price gr. <b>C107</b> (m <sup>2</sup> )	Price gr. <b>C149</b> (m <sup>2</sup> )	Price gr. <b>C116</b> (m <sup>2</sup> )	Price gr. <b>C155</b> (m <sup>2</sup> )			



<sup>2</sup> Decoration elements only available in full boxes.

Mosaic<sup>1/2</sup>

Floor Tiles<sup>1</sup>

Decoration Elements<sup>1</sup>

5 x 5 cm



30 x 60 cm

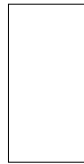

60 x 60 cm



60 x 120 cm<sup>3/4</sup>

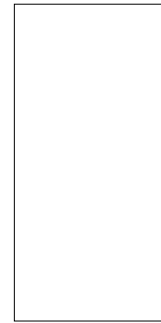

60 x 60 cm

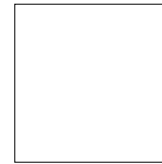

Sheet: 297 x 297 mm

Floor decor Circle

	5 x 5 / 2 x 2	30 x 60 / 12 x 24	60 x 60 / 24 x 24	60 x 120 / 24 x 48	60 x 60 / 24 x 24	Nom. dim. - cm/in
	47 x 47 x 9 mm	297 x 597 x 9 mm	597 x 597 x 9 mm	597 x 1197 x 9 mm	597 x 597 x 9 mm	Work size
	structured, matt	structured, matt	structured, matt	structured, matt	structured, matt	Surface
	11.111 sheets	5.556	2.778	1.389	2.778	m <sup>2</sup> - pieces
	19.833	19.907	20.371	21.132	20.371	m <sup>2</sup> - kg
	12 sheets	7	3	2	3	Bundle - pieces
	1.080	1.260	1.080	1.441	1.080	Bundle - m <sup>2</sup>
	21.420	25.081	21.999	30.450	21.999	Bundle - kg
	32.400	50.396	45.356	50.432	45.356	Pallet - m <sup>2</sup>
	642.600	1,003.240	923.958	1,065.750	923.958	Pallet - kg
	Bla	Bla	Bla	Bla	Bla	Product standard
	R10/A+B	R10/A+B	R10/A+B	R10/A+B	R10/A+B	Slip resistance
	2	2	2	2	2	Stress group
	<b>435901H</b>	<b>435906H</b>	<b>435911H</b>	<b>435916H</b>	<b>435921H</b>	lime <input type="checkbox"/> V3
	Price gr. C293 (m <sup>2</sup> )	Price gr. C125 (m <sup>2</sup> )	Price gr. C140 (m <sup>2</sup> )	Price gr. C152 (m <sup>2</sup> )	Price gr. C149 (m <sup>2</sup> )	bronze grey <input type="checkbox"/> V3
	<b>435902H</b>	<b>435907H</b>	<b>435912H</b>	<b>435917H</b>	<b>435922H</b>	aluminium <input type="checkbox"/> V3
	Price gr. C293 (m <sup>2</sup> )	Price gr. C125 (m <sup>2</sup> )	Price gr. C140 (m <sup>2</sup> )	Price gr. C152 (m <sup>2</sup> )	Price gr. C149 (m <sup>2</sup> )	asphalt <input type="checkbox"/> V3
	<b>435903H</b>	<b>435908H</b>	<b>435913H</b>	<b>435918H</b>	<b>435923H</b>	blue steel <input type="checkbox"/> V3
	Price gr. C293 (m <sup>2</sup> )	Price gr. C125 (m <sup>2</sup> )	Price gr. C140 (m <sup>2</sup> )	Price gr. C152 (m <sup>2</sup> )	Price gr. C149 (m <sup>2</sup> )	
	<b>435904H</b>	<b>435909H</b>	<b>435914H</b>	<b>435919H</b>	<b>435924H</b>	
	Price gr. C293 (m <sup>2</sup> )	Price gr. C125 (m <sup>2</sup> )	Price gr. C140 (m <sup>2</sup> )	Price gr. C152 (m <sup>2</sup> )	Price gr. C149 (m <sup>2</sup> )	
	<b>435905H</b>	<b>435910H</b>	<b>435915H</b>	<b>435920H</b>	<b>435925H</b>	
	Price gr. C293 (m <sup>2</sup> )	Price gr. C125 (m <sup>2</sup> )	Price gr. C140 (m <sup>2</sup> )	Price gr. C152 (m <sup>2</sup> )	Price gr. C149 (m <sup>2</sup> )	



<sup>1</sup>

<sup>2</sup> Glass fibre net on reverse side

<sup>3</sup> Please note: special pallet. No return, no exchange.

<sup>4</sup> High weight only to carry with two persons.



Stair Tile<sup>1/2</sup>

Skirting, rounded<sup>1</sup>

Patio Tile<sup>1/3</sup>

30 x 120 cm

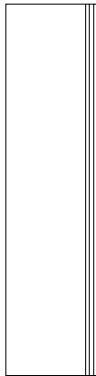

7 x 60 cm



60 x 60 cm

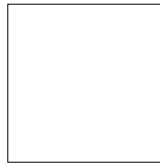

Nom. dim. - cm/in	<b>30 x 120 / 12 x 48</b>	<b>7 x 60 / 2 13/16 x 24</b>	<b>60 x 60 / 24 x 24</b>				
Work size	297 x 1197 x 9 mm	70 x 597 x 9 mm	597 x 597 x 20 mm				
Surface	structured, matt	structured, matt	structured, matt				
m <sup>2</sup> /m - pieces	0.833/m	1.667/m	2.778/m <sup>2</sup>				
m <sup>2</sup> /m - kg	6.341/m	1.357/m	45.273/m <sup>2</sup>				
Bundle - pieces	3	15	2				
Bundle - m <sup>2</sup> /m	3.601 m	8.998 m	0.720 m <sup>2</sup>				
Bundle - kg	22.836	12.210	32.594				
Pallet - m <sup>2</sup>			21.598				
Pallet - kg			977.820				
Product standard	Bla	Bla	Bla				
Slip resistance	R10/A+B		R11/B				
Stress group	2		4				
lime	<b>435930H</b> Price gr. C517 (pce.)	<b>435935H</b> Price gr. C440 (pce.)	<b>435926H</b> Price gr. C200 (m <sup>2</sup> )				
bronze grey	<b>435931H</b> Price gr. C517 (pce.)	<b>435936H</b> Price gr. C440 (pce.)	<b>435927H</b> Price gr. C200 (m <sup>2</sup> )				
aluminium	<b>435932H</b> Price gr. C517 (pce.)	<b>435937H</b> Price gr. C440 (pce.)	<b>435928H</b> Price gr. C200 (m <sup>2</sup> )				
asphalt	<b>435933H</b> Price gr. C517 (pce.)	<b>435938H</b> Price gr. C440 (pce.)	<b>435929H</b> Price gr. C200 (m <sup>2</sup> )				
blue steel	<b>435934H</b> Price gr. C517 (pce.)	<b>435939H</b> Price gr. C440 (pce.)					



<sup>3</sup> High weight only to carry with two persons.









## Innovative and robust

Specialists achieve more. This also applies to the ceramic floor tiles of the Ferrum series, which were specially developed for the tough requirements of industrial plants. The integrally colored, unglazed split tiles are particularly slip-resistant and thus prevent accidents at work. They are extremely robust and exceed the compressive strength of concrete or coating materials many times over. A technically sophisticated range of accessories, which includes cove skirtings and gutter tiles, facilitates the realization of company-specific complete solutions.

Education and Research Institute for Wine- and Fruit-growing,  
Weinsberg, Germany / Architect: Staatl. Hochbauamt / Photo: Andreas Freytag

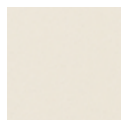

grey beige



grey-white



stone-grey

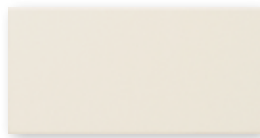

Floor tile 12.5 x 25 cm, 5 x 10 in, smooth, R10/A  
Floor tile 12.5 x 25 cm, 5 x 10 in, smooth, R11/B



Cove skirting, r = 20 mm  
12.5 x 25 cm, smooth

Mitred pair,  
smooth

Terminal piece,  
smooth

Gutter tile, smooth

Gutter tile with outlet 1½", smooth



Floor Tiles

Skirtings<sup>1</sup>

12,5 x 25 cm



12,5 x 25 cm



25 x 12,5 cm



11 mm thick

20 mm thick

r= 20 mm

				11 mm thick	20 mm thick	r= 20 mm	
				1100	1110	4035	Model number
				<b>12.5 x 25 / 5 x 10</b>	<b>12.5 x 25 / 5 x 10</b>	<b>12.5 x 25 / 5 x 10</b>	Nom. dim. - cm/in
				115 x 240 x 11 mm	115 x 240 x 20 mm	125/9 x 240 x 11 mm	Work size
				smooth, matt	smooth, matt	smooth, matt	Surface
				33.000/m <sup>2</sup>	33.000/m <sup>2</sup>	4.000/m	m <sup>2</sup> /m - pieces
				22.869/m <sup>2</sup>	41.679/m <sup>2</sup>	3.420/m	m <sup>2</sup> /m - kg
				23	13	18	Bundle - pieces
				0.697 m <sup>2</sup>	0.394 m <sup>2</sup>	4.500 m	Bundle - m <sup>2</sup> /m
				15.939	16.419	15.390	Bundle - kg
				58.545	33.091		Pallet - m <sup>2</sup>
				1,338.876	1.379.196		Pallet - kg
				Alb	Alb	Alb	Product standard
				siehe unten	siehe unten	siehe unten	Slip resistance
				2	4		Stress group
				R10/A	R10/A		
				<b>900R-1100</b>	<b>900R-1110</b>	<i>900R-4035</i>	grey beige <input type="checkbox"/> VO
				Price gr. <b>A115</b> (m <sup>2</sup> )	Price gr. <b>A211</b> (m <sup>2</sup> )	Price gr. <i>A434</i> (pce.)	
				R11/B	R11/B		
				<b>902R-1100</b>	<b>902R-1110</b>	<i>902R-4035</i>	grey-white <input type="checkbox"/> VO
				Price gr. <b>A115</b> (m <sup>2</sup> )	Price gr. <b>A211</b> (m <sup>2</sup> )	Price gr. <i>A434</i> (pce.)	
				R11/B	R11/B		
				<b>929R-1100</b>	<b>929R-1110</b>	<i>929R-4035</i>	stone-grey <input type="checkbox"/> VO
				Price gr. <b>A115</b> (m <sup>2</sup> )	Price gr. <b>A211</b> (m <sup>2</sup> )	Price gr. <i>A434</i> (pce.)	



Gutter Tiles (trough depth 15 mm)

25 x 15,6 cm

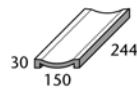

25 x 15,6 cm<sup>2</sup>

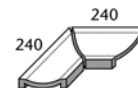

25 x 15,6 cm



Gutter tile

Gutter tile with outlet 1 1/2"

Gutter tile, mitred pair

Gutter tile, terminal piece

				54420	54421	54422	54423
				<b>25 x 15.6 / 10 x 6 1/4</b>	<b>25 x 15.6 / 10 x 6 1/4</b>		<b>25 x 15.6 / 10 x 6 1/4</b>
				244 x 150 x 30 mm	244 x 150 x 30 mm	(2x) 240 x 150 x 30 mm	244 x 150 x 30 mm
				smooth, matt	smooth, matt	smooth, matt	smooth, matt
				4.000			
				1.800/piece	1.530/piece	3.030/pair	1.950/piece
				8 piece	8 piece	4 pair	8 piece
				2.000			
				14.400	12.240	12.120	15.600
				Alb	Alb	Alb	Alb
				R10/A	R10/A	R10/A	R10/A
				<b>900-54420</b>	<b>900-54421</b>	<b>900-54422</b>	<b>900-54423</b>
				Price gr. <b>A458</b> (pce.)	Price gr. <b>A560</b> (pce.)	Price gr. <b>A581</b> (pair)	Price gr. <b>A560</b> (pce.)



<sup>1</sup> Fitting insert for the outlet: Art. no. 182 - Programme of delivery Pool + Spa 2025 (installation prior to laying)

Nosing tiles in the size of 12.5 x 25 cm can be produced with glued edge on request. The price is calculated project-specifically.

No pallet rebate is granted for the gutter tiles. Surface to be treated with a suitable impregnation agent! See page 527 in the Technical Information.







## Fresh and modern

Fresh offers a harmonious range of modern, fresh colors in the popular mosaic formats of 2.5 x 2.5 cm and 5 x 5 cm, with which individual, but at the same time uncomplicated to realize designs are possible. A particularly practical advantage is that R10/B and R11/C slip-resistant mosaics in colors matching the tiles are available.

Rendering

Fresh: modern clarity for individual design

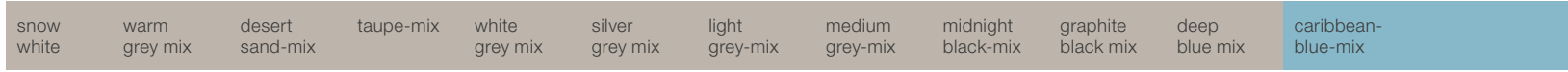

2.5 x 2.5 cm, 1 x 1 in

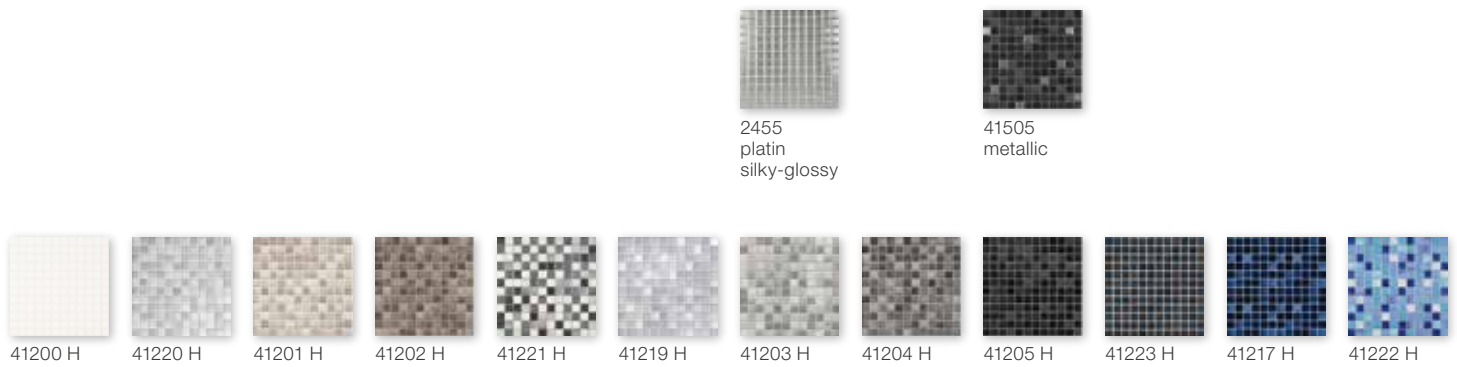

2.5 x 2.5 cm, 1 x 1 in, non-slip R10/B



5 x 5 cm, 2 x 2 in, non-slip R10/B & R11/C





denim blue-mix	light blue-mix	pacific blue-mix	midnight blue-mix	vivid violet-mix	sunset orange-mix	coral red-mix	brick red mix	mystic red-mix	forest green mix	lime green-mix	sunshine yellow-mix
-------------------	-------------------	---------------------	----------------------	---------------------	----------------------	------------------	------------------	-------------------	---------------------	-------------------	------------------------

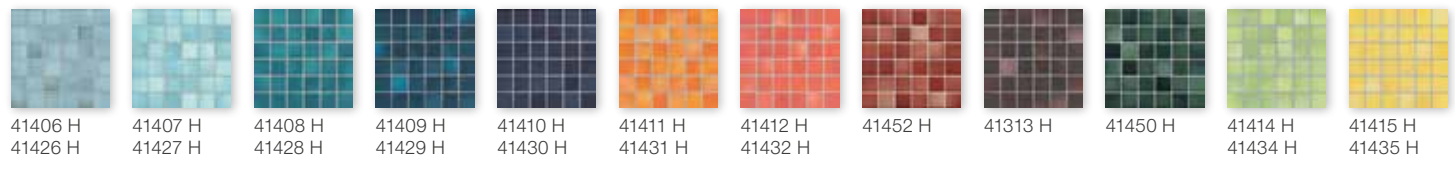
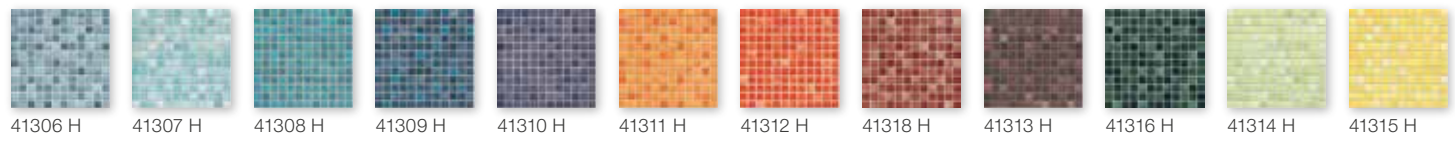
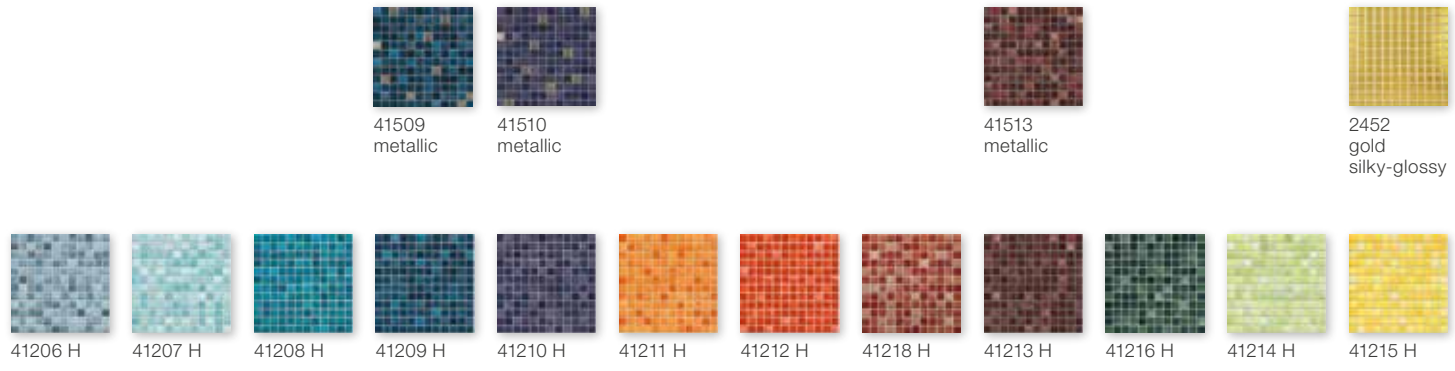

Mosaic 2.5 x 2.5 cm, 1 x 1 in



Mosaic sheet 30 x 30 cm, 12 x 12 in snow white, smooth,  
Mosaic sheet 30 x 30 cm, 12 x 12 in snow white, smooth, R10/B

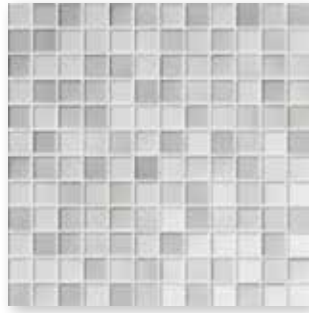

Mosaic sheet 30 x 30 cm, 12 x 12 in, warm grey-mix, smooth,  
Mosaic sheet 30 x 30 cm, 12 x 12 in, warm grey-mix, smooth, R10/B



Mosaic sheet 30 x 30 cm, 12 x 12 in desert sand-mix, smooth,  
Mosaic sheet 30 x 30 cm, 12 x 12 in desert sand-mix, smooth, R10/B



Mosaic sheet 30 x 30 cm, 12 x 12 in taupe-mix, smooth,  
Mosaic sheet 30 x 30 cm, 12 x 12 in taupe-mix, smooth, R10/B



Mosaic sheet 30 x 30 cm, 12 x 12 in white grey-mix, smooth,  
Mosaic sheet 30 x 30 cm, 12 x 12 in white grey-mix, smooth, R10/B

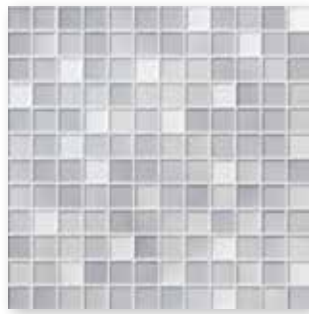

Mosaic sheet 30 x 30 cm, 12 x 12 in silver grey-mix, smooth,  
Mosaic sheet 30 x 30 cm, 12 x 12 in silver grey-mix, smooth, R10/B

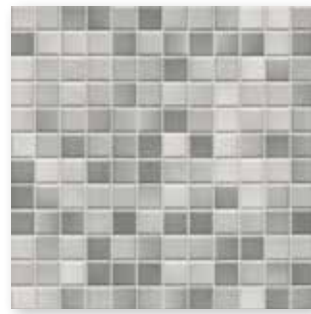

Mosaic sheet 30 x 30 cm, 12 x 12 in light grey-mix, smooth,  
Mosaic sheet 30 x 30 cm, 12 x 12 in light grey-mix, smooth, R10/B



Mosaic sheet 30 x 30 cm, 12 x 12 in medium grey-mix, smooth,  
Mosaic sheet 30 x 30 cm, 12 x 12 in medium grey-mix, smooth, R10/B

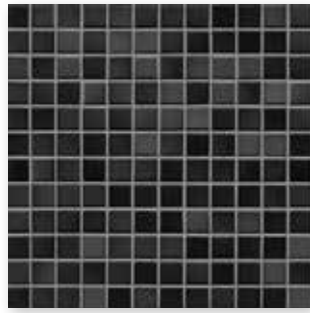

Mosaic sheet 30 x 30 cm, 12 x 12 in midnight black-mix, smooth,  
Mosaic sheet 30 x 30 cm, 12 x 12 in midnight black-mix, smooth, R10/B

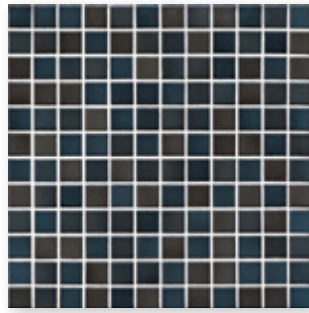

Mosaic sheet 30 x 30 cm, 12 x 12 in graphite black-mix, smooth,  
Mosaic sheet 30 x 30 cm, 12 x 12 in graphite black-mix, smooth, R10/B

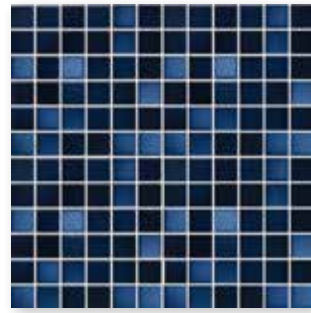

Mosaic sheet 30 x 30 cm, 12 x 12 in deep blue-mix, smooth,  
Mosaic sheet 30 x 30 cm, 12 x 12 in deep blue-mix, smooth, R10/B

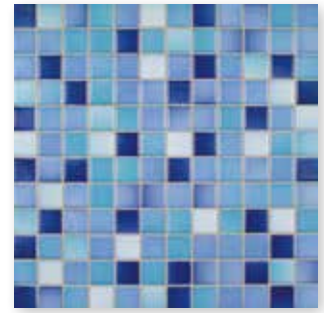

Mosaic sheet 30 x 30 cm, 12 x 12 in caribbean-blue-mix, smooth,  
Mosaic sheet 30 x 30 cm, 12 x 12 in caribbean-blue-mix, smooth, R10/B

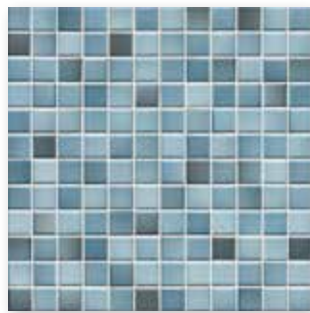

Mosaic sheet 30 x 30 cm, 12 x 12 in denim blue-mix, smooth,  
Mosaic sheet 30 x 30 cm, 12 x 12 in denim blue-mix, smooth, R10/B

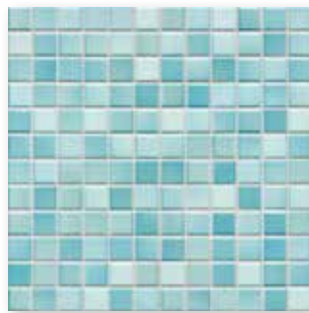

Mosaic sheet 30 x 30 cm, 12 x 12 in, light blue-mix, smooth,  
Mosaic sheet 30 x 30 cm, 12 x 12 in, light blue-mix, smooth, R10/B

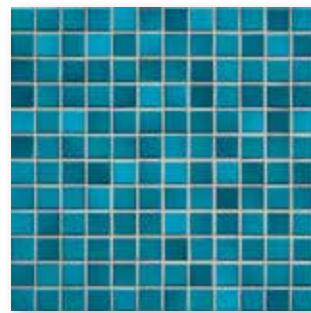

Mosaic sheet 30 x 30 cm, 12 x 12 in pacific blue-mix, smooth,  
Mosaic sheet 30 x 30 cm, 12 x 12 in pacific blue-mix, smooth, R10/B



Mosaic sheet 30 x 30 cm, 12 x 12 in midnight blue-mix, smooth,  
Mosaic sheet 30 x 30 cm, 12 x 12 in midnight blue-mix, smooth, R10/B



Mosaic sheet 30 x 30 cm, 12 x 12 in vivid violet-mix, smooth,  
Mosaic sheet 30 x 30 cm, 12 x 12 in vivid violet-mix, smooth, R10/B

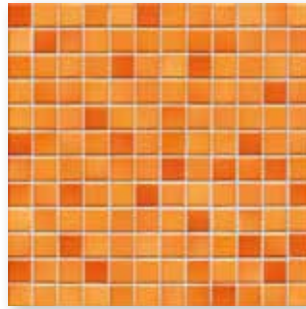

Mosaic sheet 30 x 30 cm, 12 x 12 in sunset-orange-mix, smooth,  
Mosaic sheet 30 x 30 cm, 12 x 12 in sunset-orange-mix, smooth, R10/B

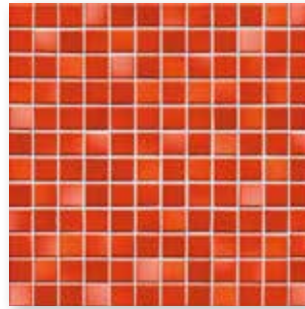

Mosaic sheet 30 x 30 cm, 12 x 12 in coral red-mix, smooth,  
Mosaic sheet 30 x 30 cm, 12 x 12 in coral red-mix, smooth, R10/B

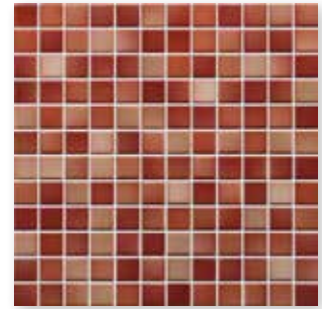

Mosaic sheet 30 x 30 cm, 12 x 12 in brick red-mix, smooth,  
Mosaic sheet 30 x 30 cm, 12 x 12 in brick red-mix, smooth, R10/B

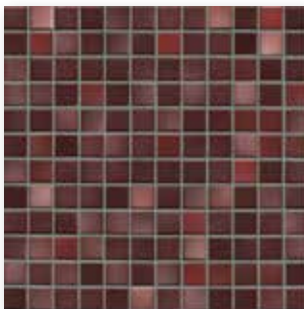

Mosaic sheet 30 x 30 cm, 12 x 12 in mystic-red-mix, smooth,  
Mosaic sheet 30 x 30 cm, 12 x 12 in mystic-red-mix, smooth, R10/B



Mosaic sheet 30 x 30 cm, 12 x 12 in forest green-mix, smooth,  
Mosaic sheet 30 x 30 cm, 12 x 12 in forest green-mix, smooth, R10/B



Mosaic sheet 30 x 30 cm, 12 x 12 in lime green-mix, smooth,  
Mosaic sheet 30 x 30 cm, 12 x 12 in lime green-mix, smooth, R10/B

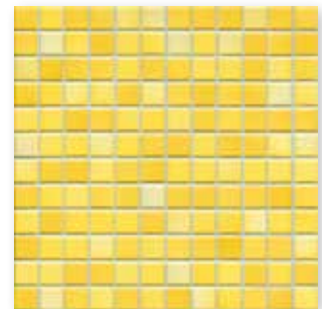

Mosaic sheet 30 x 30 cm, 12 x 12 in sunshine yellow-mix, smooth,  
Mosaic sheet 30 x 30 cm, 12 x 12 in sunshine yellow-mix, smooth, R10/B

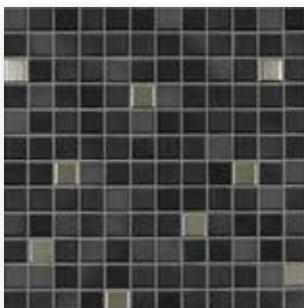

Mosaic sheet 30 x 30 cm, 12 x 12 in midnight black-mix metallic, smooth

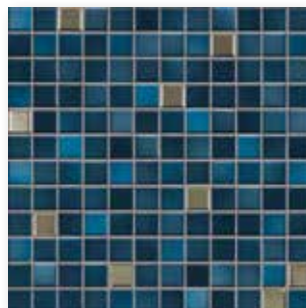

Mosaic sheet 30 x 30 cm, 12 x 12 in midnight blue-mix metallic, smooth

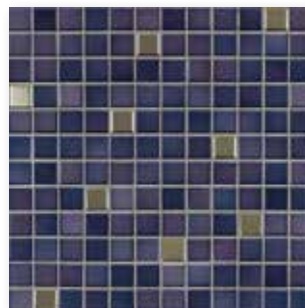

Mosaic sheet 30 x 30 cm, 12 x 12 in vivid violet-mix metallic, smooth

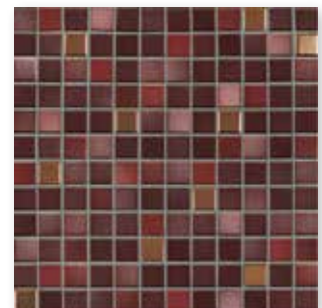

Mosaic sheet 30 x 30 cm, 12 x 12 in mystic red-mix metallic, smooth

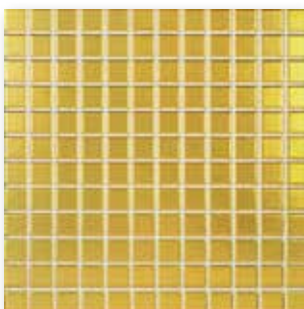

Mosaic sheet 30 x 30 cm, 12 x 12 in, gold, smooth \*

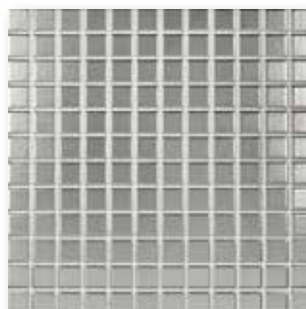

Mosaic sheet 30 x 30 cm, 12 x 12 in, platin, smooth \*

\* To prevent the abrasion of the surface coating, laying on the floor or exposure to any comparable stress must be absolutely avoided.



Mosaics glued thermoplastically on back of Agrob Buchtal can be used not only in dry zones but also without any problems in underwater areas (e.g. swimming pools/whirlpools) as well as in permanently wet areas.



Color gradient  
2.5 x 2.5 cm, 1 x 1 in



41520H  
aqua glossy

production size without external joint:  
297 x 2376 x 6.5 mm

More examples

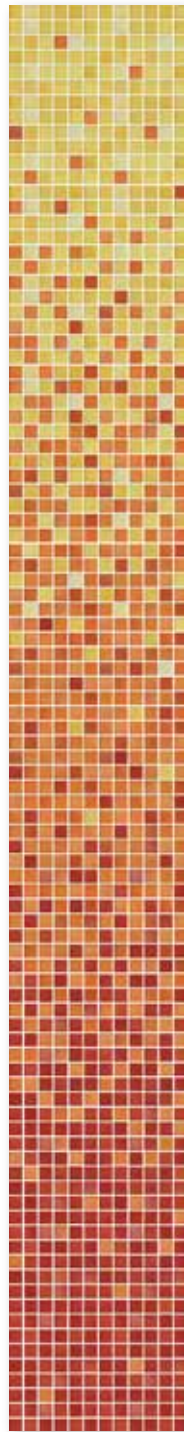

The colors of Fresh can be randomly replaced in the standard color gradient without extra charge. We will be pleased to check an individual design of color gradients with regard to dimensions and color combinations as customized production.

Do you already know our Mosaic Designer at our website [www.agrob-buchtal.com](http://www.agrob-buchtal.com)?

There, you will have the possibility of designing your individual color gradients, mosaic compositions and the laying of pictures.



Mosaic 5 x 5 cm, 2 x 2 in, non-slip



Mosaic sheet 30 x 30 cm, 12 x 12 in snow white, smooth, R10/B,  
Mosaic sheet 30 x 30 cm, 12 x 12 in snow white, smooth, R11/C



Mosaic sheet 30 x 30 cm, 12 x 12 in warm grey-mix, smooth, R10/B,  
Mosaic sheet 30 x 30 cm, 12 x 12 in warm grey-mix, smooth, R11/C



Mosaic sheet 30 x 30 cm, 12 x 12 in desert sand-mix, smooth, R10/B,  
Mosaic sheet 30 x 30 cm, 12 x 12 in desert sand-mix, smooth, R11/C



Mosaic sheet 30 x 30 cm, 12 x 12 in taupe-mix, smooth, R10/B,  
Mosaic sheet 30 x 30 cm, 12 x 12 in taupe-mix, smooth, R11/C



Mosaic sheet 30 x 30 cm, 12 x 12 in white grey-mix, smooth, R10/B



Mosaic sheet 30 x 30 cm, 12 x 12 in silver grey-mix, smooth, R10/B



Mosaic sheet 30 x 30 cm, 12 x 12 in light grey-mix, smooth, R10/B,  
Mosaic sheet 30 x 30 cm, 12 x 12 in light grey-mix, smooth, R11/C



Mosaic sheet 30 x 30 cm, 12 x 12 in medium grey-mix, smooth, R10/B,  
Mosaic sheet 30 x 30 cm, 12 x 12 in medium grey-mix, smooth, R11/C



Mosaic sheet 30 x 30 cm, 12 x 12 in midnight black-mix, smooth, R10/B,  
Mosaic sheet 30 x 30 cm, 12 x 12 in midnight black-mix, smooth, R11/C



Mosaic sheet 30 x 30 cm, 12 x 12 in graphite black-mix, smooth, R10/B

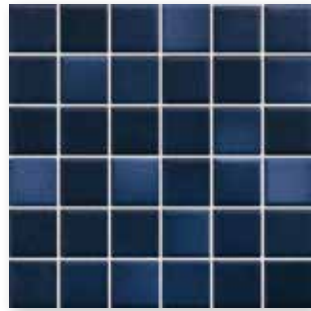

Mosaic sheet 30 x 30 cm, 12 x 12 in deep blue-mix, smooth, R10/B

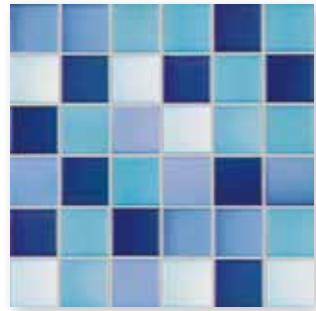

Mosaic sheet 30 x 30 cm, 12 x 12 in caribbean-blue-mix, smooth, R10/B



Mosaics glued thermoplastically on back of Agrob Buchtal can be used not only in dry zones but also without any problems in underwater areas (e.g. swimming pools/whirlpools) as well as in permanently wet areas (e.g. pool surrounds/showers).



Mosaic sheet 30 x 30 cm, 12 x 12 in denim blue-mix, smooth, R10/B,  
Mosaic sheet 30 x 30 cm, 12 x 12 in denim blue-mix, smooth, R11/C



Mosaic sheet 30 x 30 cm, 12 x 12 in light blue-mix, smooth, R10/B,  
Mosaic sheet 30 x 30 cm, 12 x 12 in light blue-mix, smooth, R11/C

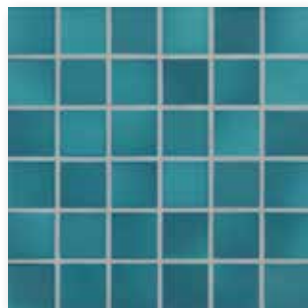

Mosaic sheet 30 x 30 cm, 12 x 12 in pacific blue-mix, smooth, R10/B,  
Mosaic sheet 30 x 30 cm, 12 x 12 in pacific blue-mix, smooth, R11/C

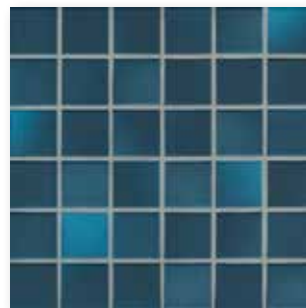

Mosaic sheet 30 x 30 cm, 12 x 12 in midnight blue-mix, smooth, R10/B,  
Mosaic sheet 30 x 30 cm, 12 x 12 in midnight blue-mix, smooth, R11/C



Mosaic sheet 30 x 30 cm, 12 x 12 in vivid violet-mix, smooth, R10/B,  
Mosaic sheet 30 x 30 cm, 12 x 12 in vivid violet-mix, smooth, R11/C

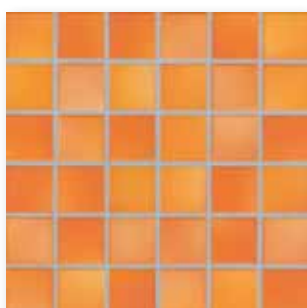

Mosaic sheet 30 x 30 cm, 12 x 12 in sunset orange-mix, smooth, R10/B,  
Mosaic sheet 30 x 30 cm, 12 x 12 in sunset orange-mix, smooth, R11/C

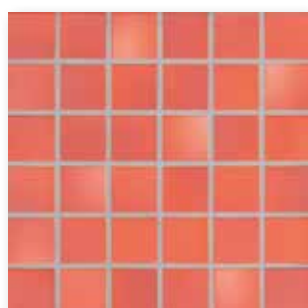

Mosaic sheet 30 x 30 cm coral red-mix, smooth, R10/B,  
Mosaic sheet 30 x 30 cm, 12 x 12 in coral red-mix, smooth, R11/C

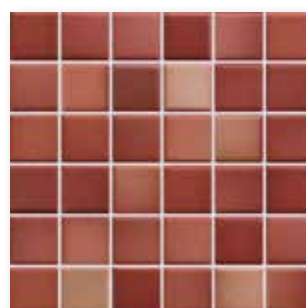

Mosaic sheet 30 x 30 cm, 12 x 12 in brick red-mix, smooth, R10/B

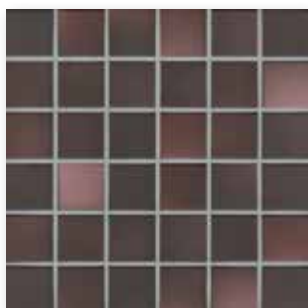

Mosaic sheet 30 x 30 cm, 12 x 12 in mystic red-mix, smooth, R10/B,  
Mosaic sheet 30 x 30 cm, 12 x 12 in mystic red-mix, smooth, R11/C



Mosaic sheet 30 x 30 cm, 12 x 12 in forest green-mix, smooth, R10/B

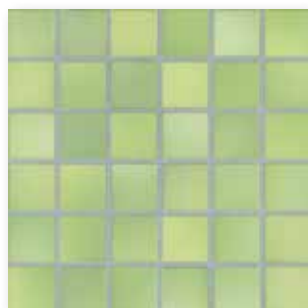

Mosaic sheet 30 x 30 cm, 12 x 12 in lime green-mix, smooth, R10/B,  
Mosaic sheet 30 x 30 cm, 12 x 12 in lime green-mix, smooth, R11/C

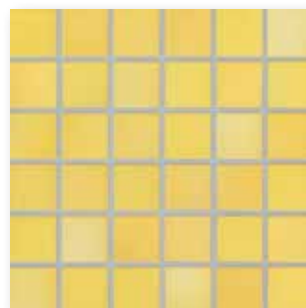

Mosaic sheet 30 x 30 cm, 12 x 12 in sunshine yellow-mix, smooth, R10/B,  
Mosaic sheet 30 x 30 cm, 12 x 12 in sunshine yellow-mix, smooth, R11/C

Mosaic

Color Gradient <sup>1</sup>

2,5 x 2,5 cm



2,5 x 2,5 cm



Sheet: 297 x 297 mm

Sheet: 297 x 297 mm

Nom. dim. - cm/in	2.5 x 2.5 / 1 x 1	2.5 x 2.5 / 1 x 1				
Work size	23 x 23 x 6.5 mm	23 x 23 x 6.5 mm				
Surface	smooth, glossy	smooth, glossy				
m <sup>2</sup> - pieces	11 sheets	11 sheets				
m <sup>2</sup> - kg	12.100					
Bundle - pieces	11 sheets	8 sheets				
Bundle - m <sup>2</sup>	1.000	0.800				
Bundle - kg	12.100	8.800				
Pallet - m <sup>2</sup>	48.000					
Pallet - kg	580.800					
Product standard	Blb	Blb				
Slip resistance						
Stress group	1	1				
stress group	3					
snow white <input type="checkbox"/>	<b>41200H</b> Price gr. <b>A229</b> (m <sup>2</sup> )					
desert sand-mix <input type="checkbox"/>	3 <b>41201H</b> Price gr. <b>A229</b> (m <sup>2</sup> )					
taupe-mix <input type="checkbox"/>	3 <b>41202H</b> Price gr. <b>A229</b> (m <sup>2</sup> )					
light grey-mix <input type="checkbox"/>	3 <b>41203H</b> Price gr. <b>A229</b> (m <sup>2</sup> )					
medium grey-mix <input type="checkbox"/>	3 <b>41204H</b> Price gr. <b>A229</b> (m <sup>2</sup> )					
midnight black-mix <input type="checkbox"/>	2 <b>41205H</b> Price gr. <b>A229</b> (m <sup>2</sup> )					
denim blue-mix <input type="checkbox"/>	3 <b>41206H</b> Price gr. <b>A250</b> (m <sup>2</sup> )					
light blue-mix <input type="checkbox"/>	3 <b>41207H</b> Price gr. <b>A250</b> (m <sup>2</sup> )					
pacific blue-mix <input type="checkbox"/>	3 <b>41208H</b> Price gr. <b>A250</b> (m <sup>2</sup> )					
midnight blue-mix <input type="checkbox"/>	3 <b>41209H</b> Price gr. <b>A250</b> (m <sup>2</sup> )					
vivid violet-mix <input type="checkbox"/>	2 <b>41210H</b> Price gr. <b>A250</b> (m <sup>2</sup> )					
sunset orange-mix <input type="checkbox"/>	3 <b>41211H</b> Price gr. <b>A250</b> (m <sup>2</sup> )					
coral red-mix <input type="checkbox"/>	3 <b>41212H</b> Price gr. <b>A250</b> (m <sup>2</sup> )					
mystic red-mix <input type="checkbox"/>	2 <b>41213H</b> Price gr. <b>A250</b> (m <sup>2</sup> )					
lime green-mix <input type="checkbox"/>	3 <b>41214H</b> Price gr. <b>A250</b> (m <sup>2</sup> )					
sunshine <input type="checkbox"/>	3 <b>41215H</b> Price gr. <b>A250</b> (m <sup>2</sup> )					
yellow-mix <input type="checkbox"/>						
aqua <input type="checkbox"/>						
glossy <input type="checkbox"/>		<b>41520H</b> Price gr. <b>A750</b> (pce.)				

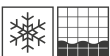

<sup>1</sup> Work size without external joint: 297 x 2376 mm

The indicated price refers to the color gradient = 8 sheets

Color gradients can be designed individually. We would be delighted to examine the possibility of such customized production in individual cases.

Do you already know our Mosaic Designer at our website [www.agrob-buchthal.com](http://www.agrob-buchthal.com)?

There, you will have the possibility of designing your individual color gradients, mosaic compositions and the laying of pictures.



Mosaic

2,5 x 2,5 cm

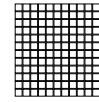

Sheet: 297 x 297 mm



						2.5 x 2.5 / 1 x 1		Nom. dim. - cm/in
						23 x 23 x 6.5 mm		Work size
						smooth, glossy		Surface
						11 sheets		m <sup>2</sup> - pieces
						12.100		m <sup>2</sup> - kg
						11 sheets		Bundle - pieces
						1.000		Bundle - m <sup>2</sup>
						12.100		Bundle - kg
						48.000		Pallet - m <sup>2</sup>
						580.800		Pallet - kg
						BIb		Product standard
								Slip resistance
						1		Stress group
						<b>41216H</b>	2	forest green mix <input type="checkbox"/> V2
						Price gr. <b>A250</b> (m <sup>2</sup> )		
						<b>41217H</b>	2	deep blue mix <input type="checkbox"/> V2
						Price gr. <b>A250</b> (m <sup>2</sup> )		
						<b>41218H</b>	2	brick red mix <input type="checkbox"/> V2
						Price gr. <b>A250</b> (m <sup>2</sup> )		
						<b>41219H</b>	3	silver grey mix <input type="checkbox"/> V2
						Price gr. <b>A250</b> (m <sup>2</sup> )		
						<b>41220H</b>	3	warm grey mix <input type="checkbox"/> V2
						Price gr. <b>A250</b> (m <sup>2</sup> )		
						<b>41221H</b>	2	white grey mix <input type="checkbox"/> V2
						Price gr. <b>A250</b> (m <sup>2</sup> )		
						<b>41222H</b>	2	caribbean-blue-mix <input type="checkbox"/> V2
						Price gr. <b>A250</b> (m <sup>2</sup> )		
						<b>41223H</b>	2	graphite black mix <input type="checkbox"/> V2
						Price gr. <b>A250</b> (m <sup>2</sup> )		
						<b>41505<sup>3</sup></b>		midnight black-mix
						Price gr. <b>A458</b> (pce.)		metallic glossy <input type="checkbox"/> V2
						<b>41509<sup>3</sup></b>		midnight blue-mix
						Price gr. <b>A458</b> (pce.)		metallic glossy <input type="checkbox"/> V2
						<b>41510<sup>3</sup></b>		vivid violet-mix
						Price gr. <b>A458</b> (pce.)		metallic glossy <input type="checkbox"/> V2
						<b>41513<sup>1/3</sup></b>	1	mystic red-mix
						Price gr. <b>A458</b> (pce.)		metallic glossy <input type="checkbox"/> V2
						<b>2452<sup>2/3</sup></b>		gold
						Price gr. <b>A394</b> (m <sup>2</sup> )		silk-glossy <input type="checkbox"/> V1
						<b>2455<sup>2/3</sup></b>		platinum
						Price gr. <b>A394</b> (m <sup>2</sup> )		silk-glossy <input type="checkbox"/> V1

- <sup>1</sup> Not or only to a limited extent resistant to acids and alkalis.
- <sup>2</sup> To prevent the abrasion of the surface coating, laying on the floor or exposure to any comparable stress must be absolutely avoided.
- <sup>3</sup> without Hytect coating



Mosaic

2,5 x 2,5 cm



5 x 5 cm



5 x 5 cm



Sheet: 297 x 297 mm

Sheet: 297 x 297 mm

Sheet: 297 x 297 mm



Nom. dim. - cm/in	2.5 x 2.5 / 1 x 1	5 x 5 / 2 x 2	5 x 5 / 2 x 2			
Work size	23 x 23 x 6.5 mm	47 x 47 x 6.5 mm	47 x 47 x 6.5 mm			
Surface	smooth, matt	smooth, matt	smooth, matt			
m <sup>2</sup> - pieces	11 sheets	11 sheets	11 sheets			
m <sup>2</sup> - kg	12.100	12.331	12.331			
Bundle - pieces	11 sheets	11 sheets	11 sheets			
Bundle - m <sup>2</sup>	1.000	1.000	1.000			
Bundle - kg	12.100	12.331	12.331			
Pallet - m <sup>2</sup>	48.000	64.000	64.000			
Pallet - kg	580.800	789.184	789.184			
Product standard	Blb	Blb	Blb			
Slip resistance	R10/B	R10/B	R11/C			
Stress group	1	1	1			
	4					
snow white <input type="checkbox"/>	<b>41300H</b> Price gr. <b>A238</b> (m <sup>2</sup> )	<b>41400H-73</b> Price gr. <b>A196</b> (m <sup>2</sup> )	<b>41420H</b> Price gr. <b>A211</b> (m <sup>2</sup> )			
desert sand-mix <input type="checkbox"/>	<b>41301H</b> Price gr. <b>A238</b> (m <sup>2</sup> )	<b>41401H-73</b> Price gr. <b>A196</b> (m <sup>2</sup> )	<b>41421H</b> Price gr. <b>A211</b> (m <sup>2</sup> )			
taupe-mix <input type="checkbox"/>	3 <b>41302H</b> Price gr. <b>A238</b> (m <sup>2</sup> )	<b>41402H-73</b> Price gr. <b>A196</b> (m <sup>2</sup> )	<b>41422H</b> Price gr. <b>A211</b> (m <sup>2</sup> )			
light grey-mix <input type="checkbox"/>	4 <b>41303H</b> Price gr. <b>A238</b> (m <sup>2</sup> )	<b>41403H-73</b> Price gr. <b>A196</b> (m <sup>2</sup> )	<b>41423H</b> Price gr. <b>A211</b> (m <sup>2</sup> )			
medium grey-mix <input type="checkbox"/>	4 <b>41304H</b> Price gr. <b>A238</b> (m <sup>2</sup> )	<b>41404H-73</b> Price gr. <b>A196</b> (m <sup>2</sup> )	<b>41424H</b> Price gr. <b>A211</b> (m <sup>2</sup> )			
midnight black-mix <input type="checkbox"/>	3 <b>41305H</b> Price gr. <b>A238</b> (m <sup>2</sup> )	<b>41405H-73</b> Price gr. <b>A196</b> (m <sup>2</sup> )	<b>41425H</b> Price gr. <b>A211</b> (m <sup>2</sup> )			
denim blue-mix <input type="checkbox"/>	3 <b>41306H</b> Price gr. <b>A259</b> (m <sup>2</sup> )	<b>41406H</b> Price gr. <b>A217</b> (m <sup>2</sup> )	<b>41426H</b> Price gr. <b>A229</b> (m <sup>2</sup> )			
light blue-mix <input type="checkbox"/>	3 <b>41307H</b> Price gr. <b>A259</b> (m <sup>2</sup> )	<b>41407H</b> Price gr. <b>A217</b> (m <sup>2</sup> )	<b>41427H</b> Price gr. <b>A229</b> (m <sup>2</sup> )			
pacific blue-mix <input type="checkbox"/>	4 <b>41308H</b> Price gr. <b>A259</b> (m <sup>2</sup> )	<b>41408H</b> Price gr. <b>A217</b> (m <sup>2</sup> )	<b>41428H</b> Price gr. <b>A229</b> (m <sup>2</sup> )			
midnight blue-mix <input type="checkbox"/>	3 <b>41309H</b> Price gr. <b>A259</b> (m <sup>2</sup> )	<b>41409H</b> Price gr. <b>A217</b> (m <sup>2</sup> )	<b>41429H</b> Price gr. <b>A229</b> (m <sup>2</sup> )			
vivid violet-mix <input type="checkbox"/>	3 <b>41310H</b> Price gr. <b>A259</b> (m <sup>2</sup> )	<b>41410H</b> Price gr. <b>A217</b> (m <sup>2</sup> )	<b>41430H</b> Price gr. <b>A229</b> (m <sup>2</sup> )			
sunset orange-mix <input type="checkbox"/>	4 <b>41311H</b> Price gr. <b>A259</b> (m <sup>2</sup> )	<b>41411H</b> Price gr. <b>A217</b> (m <sup>2</sup> )	<b>41431H</b> Price gr. <b>A229</b> (m <sup>2</sup> )			
coral red-mix <input type="checkbox"/>	3 <b>41312H</b> Price gr. <b>A259</b> (m <sup>2</sup> )	<b>41412H</b> Price gr. <b>A217</b> (m <sup>2</sup> )	<b>41432H</b> Price gr. <b>A229</b> (m <sup>2</sup> )			
mystic red-mix <input type="checkbox"/>	3 <b>41313H</b> Price gr. <b>A259</b> (m <sup>2</sup> )	<b>41413H</b> Price gr. <b>A217</b> (m <sup>2</sup> )	<b>41433H</b> Price gr. <b>A229</b> (m <sup>2</sup> )			
lime green-mix <input type="checkbox"/>	3 <b>41314H</b> Price gr. <b>A259</b> (m <sup>2</sup> )	<b>41414H</b> Price gr. <b>A217</b> (m <sup>2</sup> )	<b>41434H</b> Price gr. <b>A229</b> (m <sup>2</sup> )			
sunshine yellow-mix <input type="checkbox"/>	4 <b>41315H</b> Price gr. <b>A259</b> (m <sup>2</sup> )	<b>41415H</b> Price gr. <b>A217</b> (m <sup>2</sup> )	<b>41435H</b> Price gr. <b>A229</b> (m <sup>2</sup> )			
forest green mix <input type="checkbox"/>	3 <b>41316H</b> Price gr. <b>A259</b> (m <sup>2</sup> )	<b>41450H</b> Price gr. <b>A217</b> (m <sup>2</sup> )				
deep blue mix <input type="checkbox"/>	2 <b>41317H</b> Price gr. <b>A259</b> (m <sup>2</sup> )	<b>41451H</b> Price gr. <b>A217</b> (m <sup>2</sup> )				
brick red mix <input type="checkbox"/>	3 <b>41318H</b> Price gr. <b>A259</b> (m <sup>2</sup> )	<b>41452H</b> Price gr. <b>A217</b> (m <sup>2</sup> )				
silver grey mix <input type="checkbox"/>	4 <b>41319H</b> Price gr. <b>A259</b> (m <sup>2</sup> )	<b>41453H</b> Price gr. <b>A217</b> (m <sup>2</sup> )				
warm grey mix <input type="checkbox"/>	4 <b>41320H</b> Price gr. <b>A259</b> (m <sup>2</sup> )	<b>41454H</b> Price gr. <b>A217</b> (m <sup>2</sup> )				
white grey mix <input type="checkbox"/>	3 <b>41321H</b> Price gr. <b>A259</b> (m <sup>2</sup> )	<b>41455H</b> Price gr. <b>A217</b> (m <sup>2</sup> )				
carribbean blue mix <input type="checkbox"/>	4 <b>41322H</b> Price gr. <b>A259</b> (m <sup>2</sup> )	<b>41456H</b> Price gr. <b>A217</b> (m <sup>2</sup> )				
graphite black mix <input type="checkbox"/>	3 <b>41323H</b> Price gr. <b>A259</b> (m <sup>2</sup> )	<b>41457H</b> Price gr. <b>A217</b> (m <sup>2</sup> )				

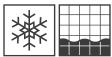







## Homage to craftsmanship

The Karl collection interprets craftsmanship and original glazes in an exceptionally creative manner. Due to the type of glaze and the raw material recipe, different tile patterns are created each time during the firing process, which – laid as surface covering – radiate authentic and elementary appeal: symbolizing the simple life with the focus on the essential. The glazed variant is primarily recommended for wall design; the stone-matt version also for floors thanks to R10/B slip resistance. With the 2.5 x 2.5 cm variant, larger surfaces, columns or other structures can be designed particularly impressively. Like a tailor-made ceramic dress. The Stories series is recommended as suitable floor tile.

Studio photo / Architect: VSBL, Belgrade, Serbia / Photo: Jochen Stüber

Mosaic 2.5 x 2.5 cm, 1 x 1 in

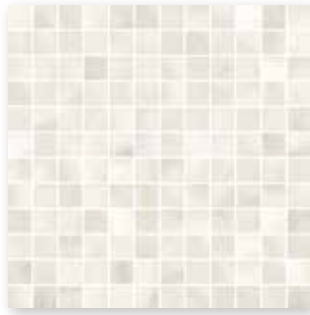

Mosaic sheet 30 x 30 cm, 12 x 12 in white structured,  
Mosaic sheet 30 x 30 cm, 12 x 12 in white, structured, R10/B



Mosaic sheet 30 x 30 cm, 12 x 12 in nude, structured,  
Mosaic sheet 30 x 30 cm, 12 x 12 in nude, structured, R10/B

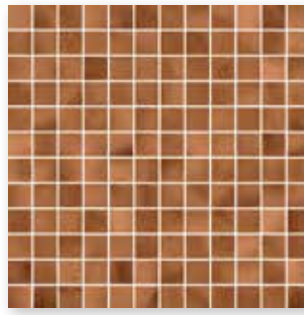

Mosaic sheet 30 x 30 cm, 12 x 12 in terra, structured,  
Mosaic sheet 30 x 30 cm, 12 x 12 in terra, structured, R10/B

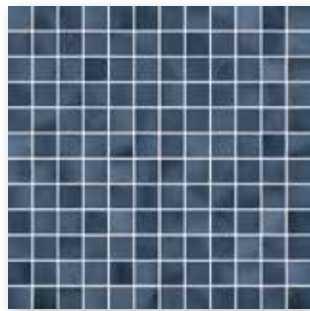

Mosaic sheet 30 x 30 cm, 12 x 12 in indigo, structured,  
Mosaic sheet 30 x 30 cm, 12 x 12 in indigo, structured, R10/B

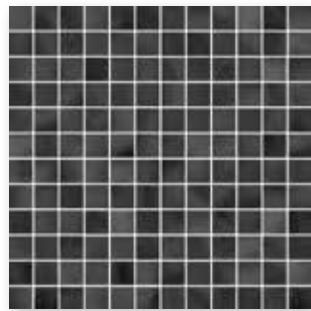

Mosaic sheet 30 x 30 cm, 12 x 12 in black, structured,  
Mosaic sheet 30 x 30 cm, 12 x 12 in black, structured, R10/B



Mosaics glued thermoplastically on back of Agrob Buchtal can be used not only in dry zones but also without any problems in underwater areas (e.g. swimming pools/whirlpools) as well as in permanently wet areas.

## Mosaic 10 x 10 cm, 4 x 4 in



Mosaic sheet 30 x 30 cm, 12 x 12 in  
white, structured,  
Mosaic sheet 30 x 30 cm, 12 x 12 in  
white, structured, R10/B



Mosaic sheet 30 x 30 cm, 12 x 12 in  
nude, structured,  
Mosaic sheet 30 x 30 cm, 12 x 12 in  
nude, structured, R10/B



Mosaic sheet 30 x 30 cm, 12 x 12 in  
terra, structured,  
Mosaic sheet 30 x 30 cm, 12 x 12 in  
terra, structured, R10/B



Mosaic sheet 30 x 30 cm, 12 x 12 in  
indigo, structured,  
Mosaic sheet 30 x 30 cm, 12 x 12 in  
indigo, structured, R10/B



Mosaic sheet 30 x 30 cm, 12 x 12 in  
black, structured,  
Mosaic sheet 30 x 30 cm, 12 x 12 in  
black, structured, R10/B



Mosaic sheet 30 x 30 cm, 12 x 12 in  
forest, structured,  
Mosaic sheet 30 x 30 cm, 12 x 12 in  
forest, structured, R10/B

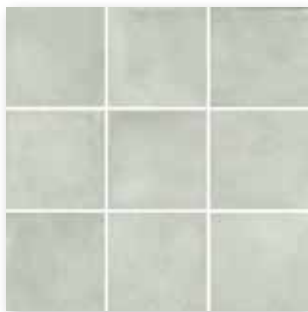

Mosaic sheet 30 x 30 cm, 12 x 12 in  
grey green, structured,  
Mosaic sheet 30 x 30 cm, 12 x 12 in  
grey green, structured, R10/B

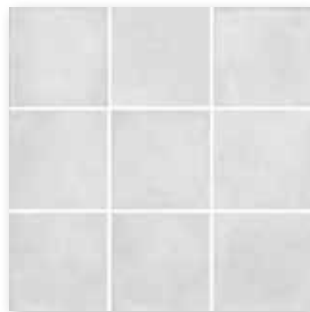

Mosaic sheet 30 x 30 cm, 12 x 12 in  
grey, structured,  
Mosaic sheet 30 x 30 cm, 12 x 12 in  
grey, structured, R10/B

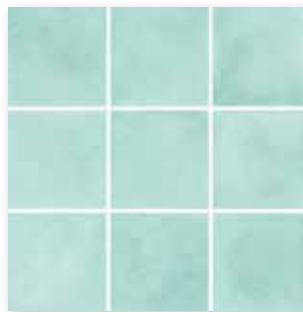

Mosaic sheet 30 x 30 cm, 12 x 12 in  
aqua, structured,  
Mosaic sheet 30 x 30 cm, 12 x 12 in  
aqua, structured, R10/B

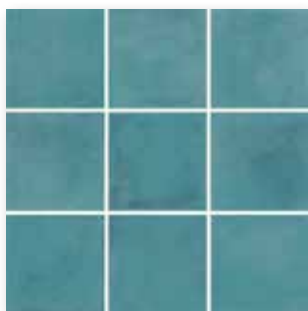

Mosaic sheet 30 x 30 cm, 12 x 12 in  
ocean blue, structured,  
Mosaic sheet 30 x 30 cm, 12 x 12 in  
ocean blue, structured, R10/B



Wall tile 10 x 25 cm, 4 x 10 in white, structured



Wall tile 10 x 25 cm, 4 x 10 in nude, structured

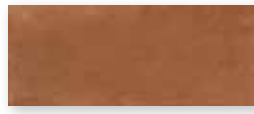

Wall tile 10 x 25 cm, 4 x 10 in terra, structured



Wall tile 10 x 25 cm, 4 x 10 in indigo, structured

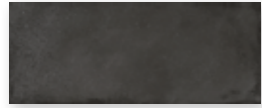

Wall tile 10 x 25 cm, 4 x 10 in black, structured

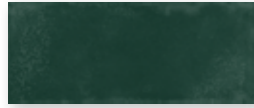

Wall tile 10 x 25 cm, 4 x 10 in forest, structured

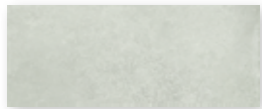

Wall tile 10 x 25 cm, 4 x 10 in grey green, structured



Wall tile 10 x 25 cm, 4 x 10 in grey, structured



Wall tile 10 x 25 cm, 4 x 10 in aqua, structured



Wall tile 10 x 25 cm, 4 x 10 in ocean blue, structured



Mosaic<sup>1</sup>

Wall Tile

2,5 x 2,5 cm

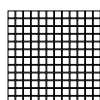

2,5 x 2,5 cm

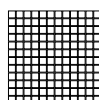

10 x 10 cm

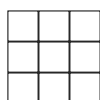

10 x 10 cm

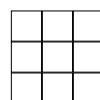

10 x 25 cm



Sheet: 297 x 297 mm

Sheet: 297 x 297 mm

Sheet: 297 x 297 mm

Sheet: 297 x 297 mm

	2.5 x 2.5 / 1 x 1	2.5 x 2.5 / 1 x 1	10 x 10 / 4 x 4	10 x 10 / 4 x 4	10 x 25 / 4 x 10	Nom. dim. - cm/in
	23 x 23 x 6.5 mm	23 x 23 x 6.5 mm	97 x 97 x 6.5 mm	97 x 97 x 6.5 mm	97 x 247 x 6.5 mm	Work size
	strukturiert, glossy	strukturiert, matt	strukturiert, glossy	strukturiert, matt	strukturiert, glossy	Surface
	11 sheets	11 sheets	11 sheets	11 sheets	40.000	m <sup>2</sup> - pieces
	12.100	12.100	13.101	13.101	12.560	m <sup>2</sup> - kg
	11 sheets	11 sheets	11 sheets	11 sheets	27	Bundle - pieces
	1.000	1.000	1.000	1.000	0.675	Bundle - m <sup>2</sup>
	12.100	12.100	13.101	13.101	8.478	Bundle - kg
	48.000	48.000	64.000	64.000	86.400	Pallet - m <sup>2</sup>
	580.800	580.800	838.464	838.464	1.058.184	Pallet - kg
	Bla (GL)	Bla (UGL)	Bla (GL)	Bla (UGL)	Bla (GL)	Product standard
		R10/B		R10/B		Slip resistance
	1	1	1	1	1	Stress group
	<b>47050H</b>	<b>47075H</b>	<b>47250H</b>	<b>47275H</b>	<b>47650H</b>	white <input type="checkbox"/> V3
	Price gr. <b>A244</b> (m <sup>2</sup> )	Price gr. <b>A250</b> (m <sup>2</sup> )	Price gr. <b>A139</b> (m <sup>2</sup> )	Price gr. <b>A163</b> (m <sup>2</sup> )	Price gr. <b>A181</b> (m <sup>2</sup> )	
	<b>47051H</b>	<b>47076H</b>	<b>47251H</b>	<b>47276H</b>	<b>47651H</b>	nude <input type="checkbox"/> V3
	Price gr. <b>A244</b> (m <sup>2</sup> )	Price gr. <b>A250</b> (m <sup>2</sup> )	Price gr. <b>A139</b> (m <sup>2</sup> )	Price gr. <b>A163</b> (m <sup>2</sup> )	Price gr. <b>A181</b> (m <sup>2</sup> )	
	<b>47052H</b>	<b>47077H</b>	<b>47252H</b>	<b>47277H</b>	<b>47652H</b>	terra <input type="checkbox"/> V3
	Price gr. <b>A244</b> (m <sup>2</sup> )	Price gr. <b>A250</b> (m <sup>2</sup> )	Price gr. <b>A139</b> (m <sup>2</sup> )	Price gr. <b>A163</b> (m <sup>2</sup> )	Price gr. <b>A181</b> (m <sup>2</sup> )	
	<b>47053H</b>	<b>47078H</b>	<b>47253H</b>	<b>47278H</b>	<b>47653H</b>	indigo <input type="checkbox"/> V3
	Price gr. <b>A244</b> (m <sup>2</sup> )	Price gr. <b>A250</b> (m <sup>2</sup> )	Price gr. <b>A139</b> (m <sup>2</sup> )	Price gr. <b>A163</b> (m <sup>2</sup> )	Price gr. <b>A181</b> (m <sup>2</sup> )	
	<b>47054H</b>	<b>47079H</b>	<b>47254H</b>	<b>47279H</b>	<b>47654H</b>	black <input type="checkbox"/> V3
	Price gr. <b>A244</b> (m <sup>2</sup> )	Price gr. <b>A250</b> (m <sup>2</sup> )	Price gr. <b>A139</b> (m <sup>2</sup> )	Price gr. <b>A163</b> (m <sup>2</sup> )	Price gr. <b>A181</b> (m <sup>2</sup> )	
			<b>47255H</b>	<b>47280H</b>	<b>47655H</b>	forest <input type="checkbox"/> V3
			Price gr. <b>A139</b> (m <sup>2</sup> )	Price gr. <b>A163</b> (m <sup>2</sup> )	Price gr. <b>A181</b> (m <sup>2</sup> )	
			<b>47256H</b>	<b>47281H</b>	<b>47656H</b>	grey green <input type="checkbox"/> V3
			Price gr. <b>A139</b> (m <sup>2</sup> )	Price gr. <b>A163</b> (m <sup>2</sup> )	Price gr. <b>A181</b> (m <sup>2</sup> )	
			<b>47257H</b>	<b>47282H</b>	<b>47657H</b>	grey <input type="checkbox"/> V3
			Price gr. <b>A139</b> (m <sup>2</sup> )	Price gr. <b>A163</b> (m <sup>2</sup> )	Price gr. <b>A181</b> (m <sup>2</sup> )	
			<b>47258H</b>	<b>47283H</b>	<b>47658H</b>	aqua <input type="checkbox"/> V3
			Price gr. <b>A139</b> (m <sup>2</sup> )	Price gr. <b>A163</b> (m <sup>2</sup> )	Price gr. <b>A181</b> (m <sup>2</sup> )	
			<b>47259H</b>	<b>47284H</b>	<b>47659H</b>	ocean blue <input type="checkbox"/> V3
			Price gr. <b>A139</b> (m <sup>2</sup> )	Price gr. <b>A163</b> (m <sup>2</sup> )	Price gr. <b>A181</b> (m <sup>2</sup> )	







## KerAion Special glazes for operating theatres

Ideal for wall coverings in rooms where lasers are used such as e.g. operating theatres. These products perfectly meet the requirements with regard to diffusely reflecting surfaces: incident laser beams are "split up", thus preventing uncontrolled reflection. This is confirmed by the expert opinion of the Laser Medical Centre Berlin and applies to the following types of lasers normally used in medical applications:

- Argon – a typical visible laser
- Nd:YAG – a typical laser in the close-infrared range
- Excimer – a typical UV-laser
- CO<sub>2</sub> – a typical laser in the mid-infrared range

Special advantage of the large model size of 60 x 60 cm: reduced number of joints, therefore easy to clean and hygienic. Perfect complement for the floor: the static electricity conducting panel ELA 10.6 (see page 189), also in model size 60 x 60 cm.



blue



green



grey

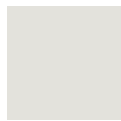

light grey



beige



white

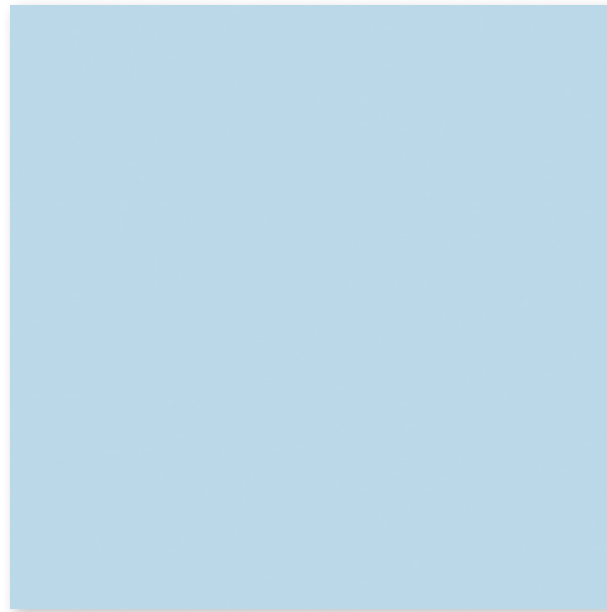

Floor/Wall panels 60 x 60 cm, 24 x 24 in, smooth

The following series is also suitable:

- matt glazes of the series Plural (see page 338 and the following)

In the chapter Technical Information you find the following additional information about this mono-colored series:

- NCS Natural Color System
- RAL-Color Chart
- Lightness Values

Floor/Wall Tiles

60 x 60 cm<sup>1</sup>

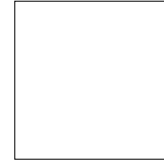

						B600HK		Model number
						60 x 60 / 24 x 24		Nom. dim. - cm/in
						597 x 597 x 8 mm		Work size
						smooth, silky-matt		Surface
						2.780		m <sup>2</sup> - pieces
						18.014		m <sup>2</sup> - kg
						4		Bundle - pieces
						1.439		Bundle - m <sup>2</sup>
						25.920		Bundle - kg
						43.165		Pallet - m <sup>2</sup>
						777.600		Pallet - kg
						Alb		Product standard
						<b>2203-B600HK</b>	4	
						Price gr. A256 (m <sup>2</sup> )		white <input type="checkbox"/> VO
						<b>2204-B600HK</b>	4	
						Price gr. A256 (m <sup>2</sup> )		beige <input type="checkbox"/> VO
						<b>2205-B600HK</b>	4	
						Price gr. A256 (m <sup>2</sup> )		light-grey <input type="checkbox"/> VO
						<b>2206-B600HK</b>	3	
						Price gr. A256 (m <sup>2</sup> )		grey <input type="checkbox"/> VO
						<b>2207-B600HK</b>	3	
						Price gr. A256 (m <sup>2</sup> )		green <input type="checkbox"/> VO
						<b>2208-B600HK</b>	4	
						Price gr. A256 (m <sup>2</sup> )		blue <input type="checkbox"/> VO

The panels of the series KerAion OP Special Glazes are also available in other sizes (up to the maximum edge length of 120 cm) and glazes. When required, please contact your advisor to customers.

The narrow joints, the large size and the Hytect coating effectively support easy cleaning and a high standard of hygiene.







## Tiles for living spaces

Tiles for living spaces – private living, gastronomy & hotels or public buildings in which the focus is on well-being. Rooms in which one likes to spend time. LIKE is a tile collection that is made to create a perfect whole in combination with other materials. The look is discreetly lively – fine irregularities give the tiles their unmistakable character and bring out each of the 5 colors perfectly. Whether mosaic or large format, the LIKE series always unfolds its full charm – both in the room and on the terrace.

Rendering



R10/A+B



graphite



ash grey



cement



warm grey



off white



Floor tile 30 x 60 cm, 12 x 24 in, structured, R10/A+B



Floor tile 60 x 60 cm, 24 x 24 in, structured, R10/A+B



Floor tile 80 x 80 cm, 32 x 32 in, structured, R10/A+B





Floor tile 120 x 120 cm, 48 x 48 in, structured, R10/A+B



Stair tile 30 x 60 cm, 12 x 24 in, 12 x 24 in (with grooves), structured, R10/A+B



Skirting, rounded 7 x 60 cm, 2 13/16 x 24 in, structured



R10/A+B



Mosaic 5 x 5 cm, 2 x 2 in

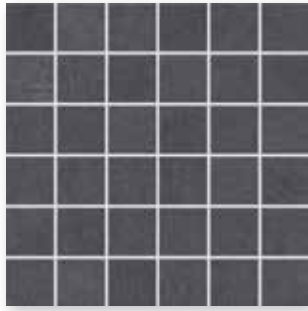

Mosaic sheet 30 x 30 cm, 12 x 12 in graphite, structured, R10/A+B

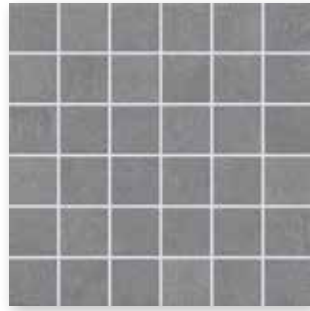

Mosaic sheet 30 x 30 cm, 12 x 12 in ash grey, structured, R10/A+B



Mosaic sheet 30 x 30 cm, 12 x 12 in cement, structured, R10/A+B



Mosaic sheet 30 x 30 cm, 12 x 12 in warm grey, structured, R10/A+B



Mosaic sheet 30 x 30 cm, 12 x 12 in off white, structured, R10/A+B

Mosaic: Glass fibre net on reverse side, Sheet: 297 x 297 mm.

Decoration elements



Border Tweed 30 x 44.5 cm, 12 x 18 in graphite, structured, R10/A+B

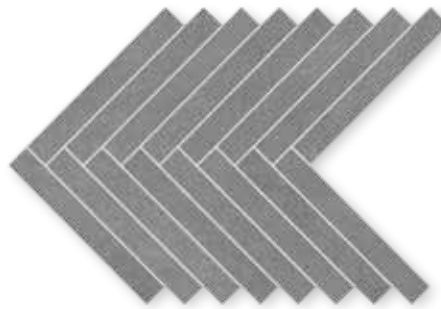

Border Tweed 30 x 44.5 cm, 12 x 18 in ash grey, structured, R10/A+B



Border Tweed 30 x 44.5 cm, 12 x 18 in cement, structured, R10/A+B



Border Tweed 30 x 44.5 cm, 12 x 18 in warm grey, structured, R10/A+B



Border Tweed 30 x 44.5 cm, 12 x 18 in off white, structured, R10/A+B

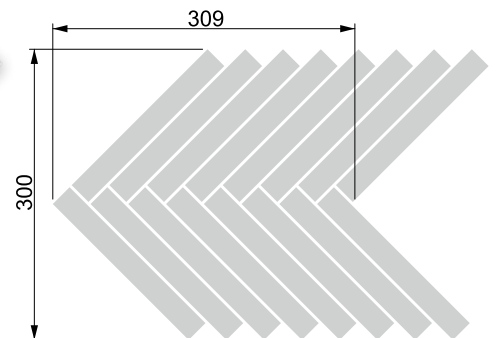

Border: Glass fibre net on reverse side, Sheet: 297 x 442 mm.



graphite



ash grey



cement



warm grey



off white



Patio tile 60 x 60 cm, 24 x 24 in, structured, R11/B



graphite



cement



Patio Tile 120 x 120 cm, 48 x 48 in, structured, R11/B

Mosaic<sup>1/3</sup>

5 x 5 cm



Sheet: 297 x 297 mm

Decoration Elements<sup>2/3</sup>

30 x 44,5 cm

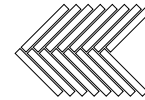

Border  
Sheet: 297 x 442 mm



protected

					<b>5 x 5</b> / 2 x 2	<b>30 x 44.5</b> / 12 x 18			Nom. dim. - cm/in
					47 x 47 x 9 mm	297 x 442 x 9 mm			Work size
					structured, matt	structured, matt			Surface
					11.111/m <sup>2</sup>	3.236/m			<b>m<sup>2</sup>/m</b> - pieces
					19.833/m <sup>2</sup>	5.191/m			<b>m<sup>2</sup>/m</b> - kg
					12	2			<b>Bundle</b> - pieces
					1.080 m <sup>2</sup>	0.618 m			<b>Bundle</b> - m <sup>2</sup> /m
					21.420	3.208			<b>Bundle</b> - kg
					32.400				<b>Pallet</b> - m <sup>2</sup>
					642.600				<b>Pallet</b> - kg
					Bla	Bla			Product standard
					R10/A+B	R10/A+B			Slip resistance
					2	2			Stress group
					<b>430640</b>	<b>430635</b>			graphite <input type="checkbox"/> V2
					Price gr. <b>W303</b> (m <sup>2</sup> )	Price gr. <b>W515</b> (pce.)			
					<b>430641</b>	<b>430636</b>			ash grey <input type="checkbox"/> V2
					Price gr. <b>W303</b> (m <sup>2</sup> )	Price gr. <b>W515</b> (pce.)			
					<b>430642</b>	<b>430637</b>			cement <input type="checkbox"/> V2
					Price gr. <b>W303</b> (m <sup>2</sup> )	Price gr. <b>W515</b> (pce.)			
					<b>430643</b>	<b>430638</b>			warm grey <input type="checkbox"/> V2
					Price gr. <b>W303</b> (m <sup>2</sup> )	Price gr. <b>W515</b> (pce.)			
					<b>430644</b>	<b>430639</b>			off white <input type="checkbox"/> V2
					Price gr. <b>W303</b> (m <sup>2</sup> )	Price gr. <b>W515</b> (pce.)			



1



<sup>2</sup> Decoration elements only available in full boxes.

<sup>3</sup> Glass fibre net on reverse side

Floor Tiles<sup>1</sup>

30 x 60 cm



60 x 60 cm





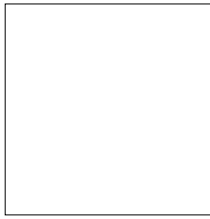

80 x 80 cm<sup>2</sup>

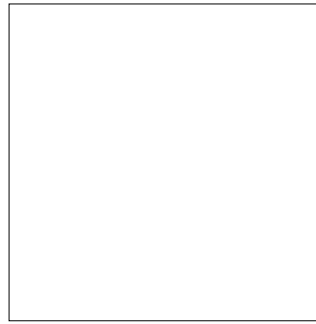

120 x 120 cm<sup>2/3</sup>



protected

Nom. dim. - cm/in	30 x 60 / 12 x 24	60 x 60 / 24 x 24	80 x 80 / 32 x 32		120 x 120 / 48 x 48		
Work size	297 x 596 x 9 mm	596 x 596 x 9 mm	795 x 795 x 9 mm		1194 x 1194 x 9 mm		
Surface	structured, matt	structured, matt	structured, matt		structured, matt		
m <sup>2</sup> - pieces	5.556	2.778	1.563		0.694		
m <sup>2</sup> - kg	19.841	19.288	21.381		21.098		
Bundle - pieces	7	3	2		2		
Bundle - m <sup>2</sup>	1.260	1.080	1.280		2.882		
Bundle - kg	24.997	20.829	27.360		60.800		
Pallet - m <sup>2</sup>	50.396	43.197	61.420		57.637		
Pallet - kg	999.880	833.160	1,313.280		1,216.000		
Product standard	Bla	Bla	Bla		Bla		
Slip resistance	R10/A+B	R10/A+B	R10/A+B		R10/A+B		
Stress group	2	2	2		2		
graphite 	<b>430645</b> Price gr. <b>W102</b> (m <sup>2</sup> )	<b>430650</b> Price gr. <b>W117</b> (m <sup>2</sup> )	<b>430655</b> Price gr. <b>W138</b> (m <sup>2</sup> )		<b>430660</b> Price gr. <b>W177</b> (m <sup>2</sup> )		
ash grey 	<b>430646</b> Price gr. <b>W102</b> (m <sup>2</sup> )	<b>430651</b> Price gr. <b>W117</b> (m <sup>2</sup> )	<b>430656</b> Price gr. <b>W138</b> (m <sup>2</sup> )		<b>430661</b> Price gr. <b>W177</b> (m <sup>2</sup> )		
cement 	<b>430647</b> Price gr. <b>W102</b> (m <sup>2</sup> )	<b>430652</b> Price gr. <b>W117</b> (m <sup>2</sup> )	<b>430657</b> Price gr. <b>W138</b> (m <sup>2</sup> )		<b>430662</b> Price gr. <b>W177</b> (m <sup>2</sup> )		
warm grey 	<b>430648</b> Price gr. <b>W102</b> (m <sup>2</sup> )	<b>430653</b> Price gr. <b>W117</b> (m <sup>2</sup> )	<b>430658</b> Price gr. <b>W138</b> (m <sup>2</sup> )		<b>430663</b> Price gr. <b>W177</b> (m <sup>2</sup> )		
off white 	<b>430649</b> Price gr. <b>W102</b> (m <sup>2</sup> )	<b>430654</b> Price gr. <b>W117</b> (m <sup>2</sup> )	<b>430659</b> Price gr. <b>W138</b> (m <sup>2</sup> )		<b>430664</b> Price gr. <b>W177</b> (m <sup>2</sup> )		



<sup>2</sup> Please note: special pallet. No return, no exchange.

<sup>3</sup> High weight only to carry with two persons.

### Stair Tile<sup>1</sup>

30 x 60 cm<sup>2</sup>

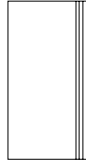

### Skirting, rounded<sup>1</sup>

7 x 60 cm



### Patio Tiles<sup>1</sup>

60 x 60 cm<sup>3</sup>



120 x 120 cm<sup>3/4</sup>

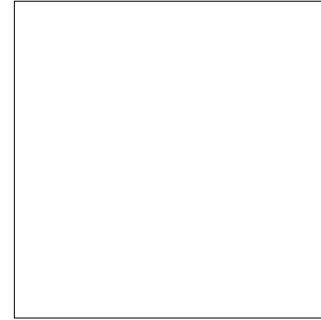

protected

	<b>30 x 60</b> / 12 x 24	<b>7 x 60</b> / 2 13/16 x 24	<b>60 x 60</b> / 24 x 24	<b>120 x 120</b> / 48 x 48		Nom. dim. - cm/in
	297 x 596 x 9 mm	70 x 596 x 9 mm	596 x 596 x 20 mm	1198 x 1198 x 20 mm		Work size
	structured, matt	structured, matt	structured, matt	structured, matt		Surface
	1.667/m	1.667/m	2.778/m <sup>2</sup>	0.700/m <sup>2</sup>		m <sup>2</sup> /m - pieces
	5.972/m	1.357/m	47.226/m <sup>2</sup>	46.567/m <sup>2</sup>		m <sup>2</sup> /m - kg
	7	22	2	1		Bundle - pieces
	4.199 m	13.197 m	0.720 m <sup>2</sup>	1.440 m <sup>2</sup>		Bundle - m <sup>2</sup> /m
	25.081	17.908	34.000	67.100		Bundle - kg
			21.598	28.563		Pallet - m <sup>2</sup>
			1,020.000	1,342.000		Pallet - kg
	Bla	Bla	Bla	Bla		Product standard
	R10/A+B		R11/B	R11/B		Slip resistance
	2		4	4		Stress group
	<b>430672</b>	<b>430677</b>	<b>430665</b>	<b>430670</b>		graphite <input type="checkbox"/> V2
	Price gr. <b>W473</b> (pce.)	Price gr. <b>W439</b> (pce.)	Price gr. <b>W177</b> (m <sup>2</sup> )	Price gr. <b>W261</b> (m <sup>2</sup> )		ash grey <input type="checkbox"/> V2
	<b>430673</b>	<b>430678</b>	<b>430666</b>			cement <input type="checkbox"/> V2
	Price gr. <b>W473</b> (pce.)	Price gr. <b>W439</b> (pce.)	Price gr. <b>W177</b> (m <sup>2</sup> )			warm grey <input type="checkbox"/> V2
	<b>430674</b>	<b>430679</b>	<b>430667</b>	<b>430671</b>		off white <input type="checkbox"/> V2
	Price gr. <b>W473</b> (pce.)	Price gr. <b>W439</b> (pce.)	Price gr. <b>W177</b> (m <sup>2</sup> )	Price gr. <b>W261</b> (m <sup>2</sup> )		
	<b>430675</b>	<b>430680</b>	<b>430668</b>			
	Price gr. <b>W473</b> (pce.)	Price gr. <b>W439</b> (pce.)	Price gr. <b>W177</b> (m <sup>2</sup> )			
	<b>430676</b>	<b>430681</b>	<b>430669</b>			
	Price gr. <b>W473</b> (pce.)	Price gr. <b>W439</b> (pce.)	Price gr. <b>W177</b> (m <sup>2</sup> )			



<sup>3</sup> High weight only to carry with two persons.

<sup>4</sup> Please note: special pallet. No return, no exchange.



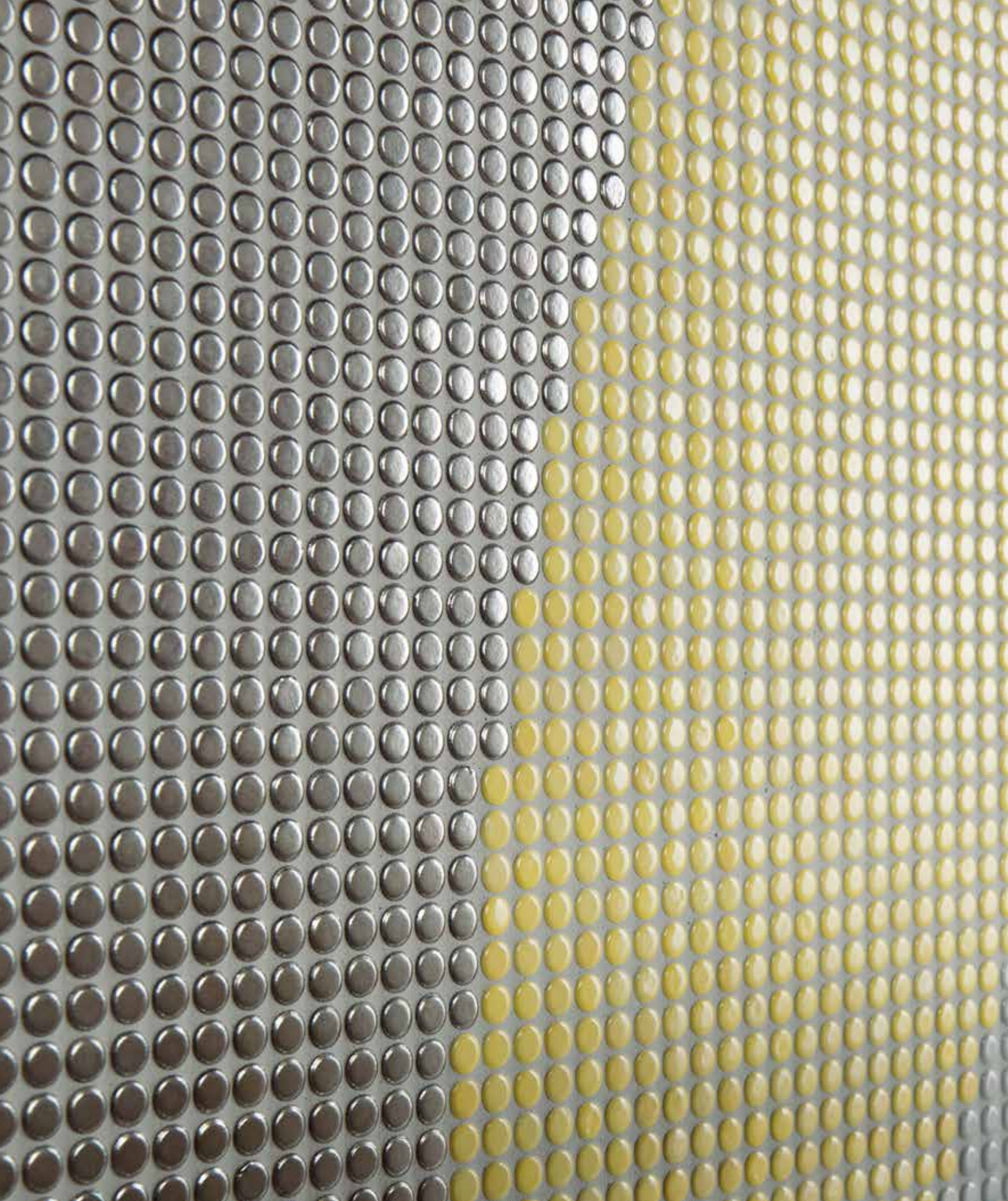





## Fine and round

The perfect answer to the trend towards soft, rounded designs is the mosaic Loop. It is available in 15 finely nuanced, high-gloss colors, six of which are also available in a matt, slip-resistant version. This extends the range of applications to showers and other wet areas. In addition x+to the mosaic with a 2 cm diameter, a 1 cm variant is also available, which conveys a particularly filigree and elegant impression. In contrasting colors, it is also suitable for pictograms, letters, arrows and QR codes.

Studio photo

Mosaic Ø 1 cm, Ø 3/8 in

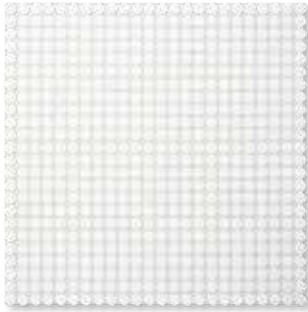

Mosaic sheet 32 x 32 cm, 13 x 13 in arctic white glossy, smooth

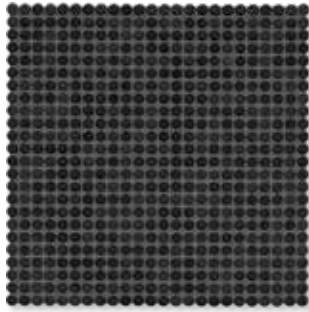

Mosaic sheet 32 x 32 cm, 13 x 13 in night black glossy, smooth



Mosaic sheet 32 x 32 cm, 13 x 13 in light ivory glossy, smooth



Mosaic sheet 32 x 32 cm, 13 x 13 in ivory glossy, smooth



Mosaic sheet 32 x 32 cm, 13 x 13 in light diamond grey glossy, smooth



Mosaic sheet 32 x 32 cm, 13 x 13 in diamond grey glossy, smooth

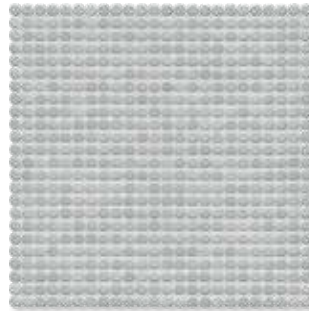

Mosaic sheet 32 x 32 cm, 13 x 13 in denim glossy, smooth



Mosaic sheet 32 x 32 cm, 13 x 13 in light aqua blue glossy, smooth

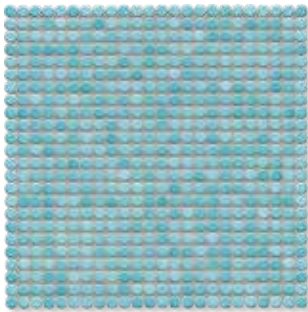

Mosaic sheet 32 x 32 cm, 13 x 13 in aqua blue glossy, smooth

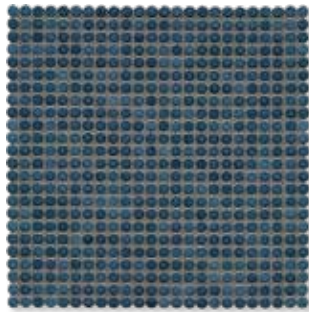

Mosaic sheet 32 x 32 cm, 13 x 13 in steel blue glossy, smooth

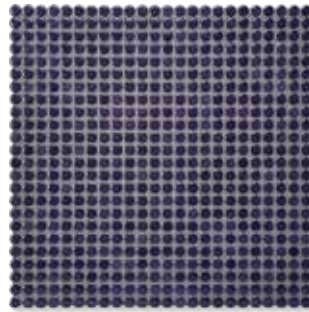

Mosaic sheet 32 x 32 cm, 13 x 13 in dark violet glossy, smooth

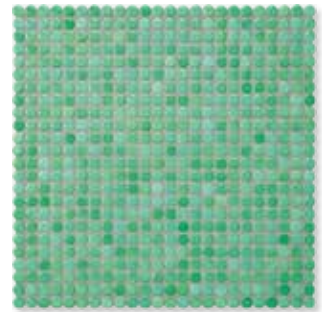

Mosaic sheet 32 x 32 cm, 13 x 13 in sea green glossy, smooth

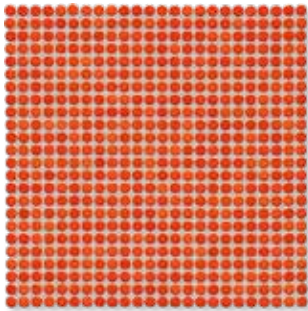

Mosaic sheet 32 x 32 cm, 13 x 13 in coral-red glossy, smooth

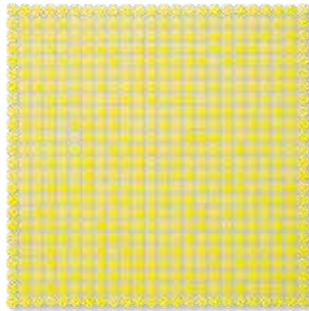

Mosaic sheet 32 x 32 cm, 13 x 13 in lemon-yellow glossy, smooth

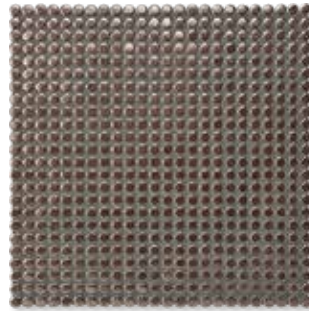

Mosaic sheet 32 x 32 cm, 13 x 13 in bronze-metallic glossy, smooth

The products depicted can also be manufactured in other colors. We would be delighted to examine the possibility of such customized production in individual cases.



Mosaics glued thermoplastically on back of Agrob Buchtal can be used not only in dry zones but also without any problems in underwater areas (e.g. swimming pools/whirlpools) as well as in permanently wet areas.

Color gradient  
Ø 1 cm, Ø 3/8 in

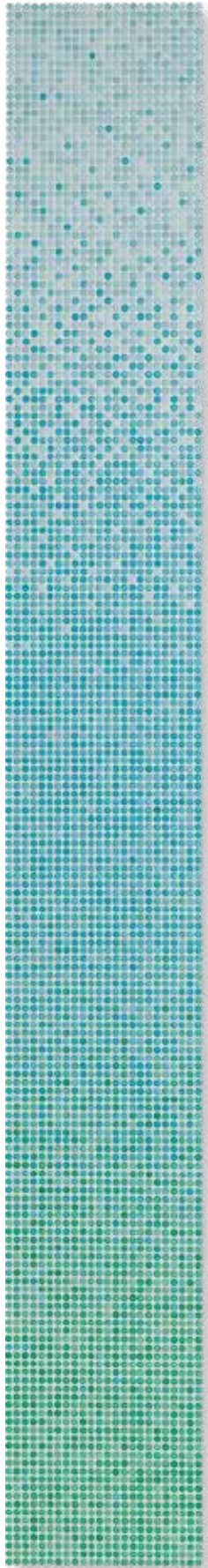

ocean glossy

Color gradient  
Ø 2 cm, Ø 6/8 in



ocean glossy

More examples

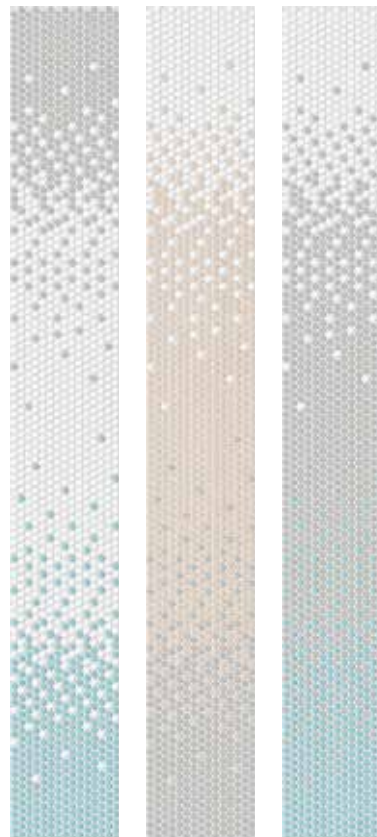
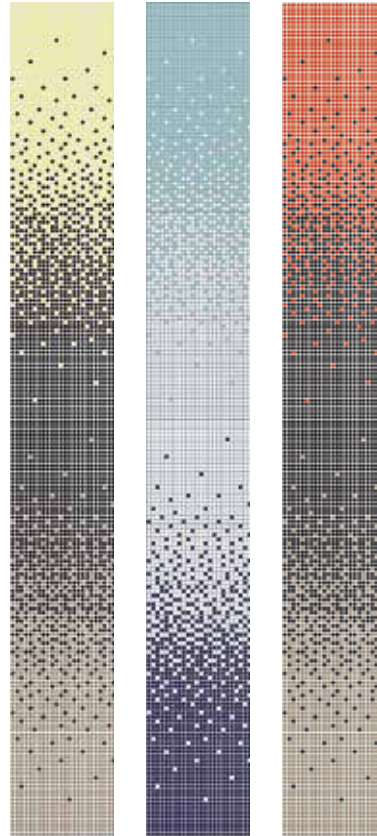

production size without external joint  
314 x 2,528 x 6.5 mm

The colors of Loop can be randomly replaced in the standard color gradient without extra charge. We will be pleased to check an individual design of color gradients with regard to dimensions and color combinations as customized production.

Do you already know our Mosaic Designer at our website [www.agrob-buchtal.com](http://www.agrob-buchtal.com)? There, you will have the possibility of designing your individual color gradients, mosaic compositions and the laying of pictures.

Mosaic Ø 2 cm, Ø 6/8 in



Mosaic sheet 32 x 32 cm, 13 x 13 in arctic white glossy, smooth,  
Mosaic sheet 32 x 32 cm, 13 x 13 in arctic white, smooth, R10/B



Mosaic sheet 32 x 32 cm, 13 x 13 in night black glossy, smooth,  
Mosaic sheet 32 x 32 cm, 13 x 13 in night black, smooth, R10/B



Mosaic sheet 32 x 32 cm, 13 x 13 in light ivory glossy, smooth,  
Mosaic sheet 32 x 32 cm, 13 x 13 in light ivory, smooth, R10/B



Mosaic sheet 32 x 32 cm, 13 x 13 in ivory glossy, smooth

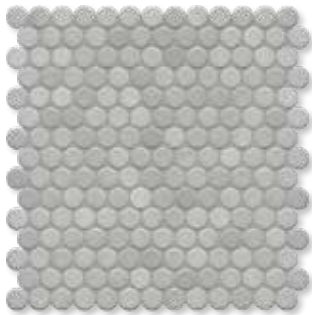

Mosaic sheet 32 x 32 cm, 13 x 13 in light diamond grey glossy, smooth,  
Mosaic sheet 32 x 32 cm, 13 x 13 in light diamond grey, smooth, R10/B



Mosaic sheet 32 x 32 cm, 13 x 13 in diamond grey glossy, smooth



Mosaic sheet 32 x 32 cm, 13 x 13 in denim glossy, smooth



Mosaic sheet 32 x 32 cm, 13 x 13 in light aqua blue glossy, smooth,  
Mosaic sheet 32 x 32 cm, 13 x 13 in light aqua blue, smooth, R10/B



Mosaic sheet 32 x 32 cm, 13 x 13 in aqua blue glossy, smooth,  
Mosaic sheet 32 x 32 cm, 13 x 13 in aqua blue, smooth, R10/B

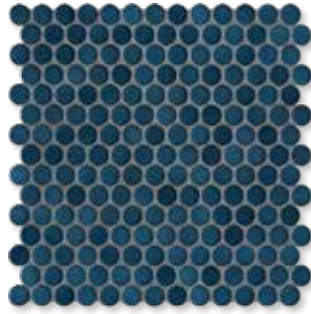

Mosaic sheet 32 x 32 cm, 13 x 13 in steel blue glossy, smooth



Mosaic sheet 32 x 32 cm, 13 x 13 in dark violet glossy, smooth



Mosaic sheet 32 x 32 cm, 13 x 13 in sea green glossy, smooth,  
Mosaic sheet 32 x 32 cm, 13 x 13 in sea green, smooth, R10/B

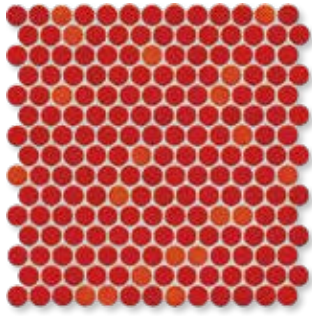

Mosaic sheet 32 x 32 cm, 13 x 13 in coral-red glossy, smooth



Mosaic sheet 32 x 32 cm, 13 x 13 in lemon-yellow glossy, smooth



Mosaic sheet 32 x 32 cm, 13 x 13 in bronze-metallic glossy, smooth



Mosaics glued thermoplastically on back of Agrob Buchtal can be used not only in dry zones but also without any problems in underwater areas (e.g. swimming pools/whirlpools) as well as in permanently wet areas.

Mosaic

Color Gradient

Ø 1 cm

Ø 2 cm

Ø 1 cm<sup>1/3</sup>

Ø 2 cm<sup>2/3</sup>

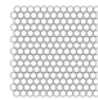
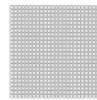

		Sheet: 316 x 316 mm	Sheet: 326 x 316 mm	Sheet: 316 x 316 mm	Sheet: 326 x 316 mm	
		Ø 1 / 3/8	Ø 2 / 6/8	Ø 1 / Ø 3/8	Ø 2 / 6/8	Nom. dim. - cm/in
		Ø 12 x 6.5 mm	Ø 22.3 x 6.5 mm	Ø 12 x 6.5 mm	Ø 22.3 x 6.5 mm	Work size
		smooth, glossy	smooth, glossy	smooth, glossy	smooth, glossy	Surface
		10 sheets	10 sheets			m <sup>2</sup> - pieces
		9.720	11.600			m <sup>2</sup> - kg
		10 sheets	10 sheets	8 sheets	8 sheets	Bundle - pieces
		1.000	1.000	0.800	0.800	Bundle - m <sup>2</sup>
		9.720	11.600	7.776	8.872	Bundle - kg
		24.000	48.000			Pallet - m <sup>2</sup>
		233.280	556.800			Pallet - kg
		Bib	Bib	Bib	Bib	Product standard
		<b>40000H</b>	<b>40020H</b>			3 arctic white
		Price gr. <b>A382</b> (m <sup>2</sup> )	Price gr. <b>A304</b> (m <sup>2</sup> )			glossy <input type="checkbox"/> V2
		<b>40001H</b>	<b>40021H</b>			2 night black
		Price gr. <b>A382</b> (m <sup>2</sup> )	Price gr. <b>A304</b> (m <sup>2</sup> )			glossy <input type="checkbox"/> V2
		<b>40002H</b>	<b>40022H</b>			3 light ivory
		Price gr. <b>A382</b> (m <sup>2</sup> )	Price gr. <b>A304</b> (m <sup>2</sup> )			glossy <input type="checkbox"/> V2
		<b>40003H</b>	<b>40023H</b>			3 ivory
		Price gr. <b>A382</b> (m <sup>2</sup> )	Price gr. <b>A304</b> (m <sup>2</sup> )			glossy <input type="checkbox"/> V2
		<b>40004H</b>	<b>40024H</b>			3 light diamond grey
		Price gr. <b>A382</b> (m <sup>2</sup> )	Price gr. <b>A304</b> (m <sup>2</sup> )			glossy <input type="checkbox"/> V2
		<b>40005H</b>	<b>40025H</b>			2 diamond grey
		Price gr. <b>A382</b> (m <sup>2</sup> )	Price gr. <b>A304</b> (m <sup>2</sup> )			glossy <input type="checkbox"/> V2
		<b>40006H</b>	<b>40026H</b>			3 denim
		Price gr. <b>A382</b> (m <sup>2</sup> )	Price gr. <b>A304</b> (m <sup>2</sup> )			glossy <input type="checkbox"/> V2
		<b>40007H</b>	<b>40027H</b>			3 light aqua blue
		Price gr. <b>A382</b> (m <sup>2</sup> )	Price gr. <b>A304</b> (m <sup>2</sup> )			glossy <input type="checkbox"/> V2
		<b>40008H</b>	<b>40028H</b>			2 aqua blue
		Price gr. <b>A382</b> (m <sup>2</sup> )	Price gr. <b>A304</b> (m <sup>2</sup> )			glossy <input type="checkbox"/> V2
		<b>40009H</b>	<b>40029H</b>			2 steel blue
		Price gr. <b>A382</b> (m <sup>2</sup> )	Price gr. <b>A304</b> (m <sup>2</sup> )			glossy <input type="checkbox"/> V2
		<b>40010H</b>	<b>40030H</b>			2 dark violet
		Price gr. <b>A382</b> (m <sup>2</sup> )	Price gr. <b>A304</b> (m <sup>2</sup> )			glossy <input type="checkbox"/> V2
		<b>40011H</b>	<b>40031H</b>			3 sea green
		Price gr. <b>A382</b> (m <sup>2</sup> )	Price gr. <b>A304</b> (m <sup>2</sup> )			glossy <input type="checkbox"/> V2
		<b>40012H</b>	<b>40032H</b>			2 coral-red
		Price gr. <b>A382</b> (m <sup>2</sup> )	Price gr. <b>A304</b> (m <sup>2</sup> )			glossy <input type="checkbox"/> V2
		<b>40013H</b>	<b>40033H</b>			3 lemon-yellow
		Price gr. <b>A382</b> (m <sup>2</sup> )	Price gr. <b>A304</b> (m <sup>2</sup> )			glossy <input type="checkbox"/> V2
		<b>40014<sup>4/5</sup></b>	<b>40034<sup>4/5</sup></b>			1 bronze-metallic <input type="checkbox"/> V2
		Price gr. <b>A385</b> (m <sup>2</sup> )	Price gr. <b>A346</b> (m <sup>2</sup> )			
				<b>40056H</b>	<b>40057H</b>	2 ocean
				Price gr. <b>A791</b> (pce.)	Price gr. <b>A750</b> (pce.)	glossy <input type="checkbox"/> V2

<sup>1</sup> Work size without external joint: 316 x 2528 x 6,5 mm

<sup>2</sup> Work size without external joint: 326 x 2528 x 6,5 mm

<sup>3</sup> Preisangabe bezieht sich auf den Farbverlauf = 8 sheets

<sup>4</sup> Not or only to a limited extent resistant to acids and alkalis.

<sup>5</sup> without Hytect



Color gradients can be designed individually. We would be delighted to examine the possibility of such customized production in individual cases.

Do you already know our Mosaic Designer at our website [www.agrob-buchtal.com](http://www.agrob-buchtal.com)?

There, you will have the possibility of designing your individual color gradients, mosaic compositions and the laying of pictures.

Mosaic

Ø 2 cm



Sheet: 326 x 316 mm

Nom. dim. - cm/in	Ø 2 / 6/8						
Work size	Ø 22.3 x 6.5 mm						
Surface	smooth, matt						
m <sup>2</sup> - pieces	10 sheets						
m <sup>2</sup> - kg	11.600						
Bundle - pieces	10 sheets						
Bundle - m <sup>2</sup>	1.000						
Bundle - kg	11.600						
Pallet - m <sup>2</sup>	48.000						
Pallet - kg	556.800						
Product standard	BIb						
Slip resistance	R10/B						
	<b>4 40040H</b>						
arctic white <input type="checkbox"/>	Price gr. <b>A313</b> (m <sup>2</sup> )						
	<b>2 40041H</b>						
night black <input type="checkbox"/>	Price gr. <b>A313</b> (m <sup>2</sup> )						
	<b>4 40042H</b>						
light ivory <input type="checkbox"/>	Price gr. <b>A313</b> (m <sup>2</sup> )						
	<b>4 40044H</b>						
light diamond grey <input type="checkbox"/>	Price gr. <b>A313</b> (m <sup>2</sup> )						
	<b>4 40047H</b>						
aqua blue light <input type="checkbox"/>	Price gr. <b>A313</b> (m <sup>2</sup> )						
	<b>3 40048H</b>						
aqua blue <input type="checkbox"/>	Price gr. <b>A313</b> (m <sup>2</sup> )						
	<b>3 40071H</b>						
sea green <input type="checkbox"/>	Price gr. <b>A313</b> (m <sup>2</sup> )						

The products depicted can also be manufactured in other colors. We would be delighted to examine the possibility of such customized production in individual cases.



Lintharena, Näfels, Switzerland / Architect: K & L Architekten AG, St. Gallen, Switzerland  
Series: Loop, special composition / Photo: Kim Britt Photography









## Natural design scope

Unique in its ceramic composition and with color nuances between anthracite and white, the series Lounge looks fantastic in any room. The Stone decor with its discreet marble and stone look is the highlight of every room design – on large or small surfaces. The colorful Garden decoration whisks us away to the exotic gardens of this world. All tiles are Hytect-coated and thus easy to clean.

Rendering

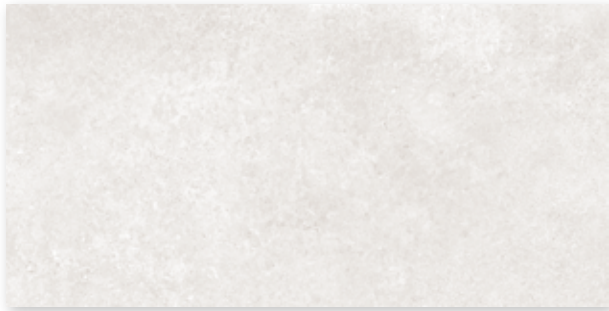

Wall tile 30 x 60 cm, 12 x 24 in, light taupe, structured



Wall tile 30 x 60 cm, 12 x 24 in, grey white, structured



Wall tile 30 x 90 cm, 12 x 36 in, light taupe, structured

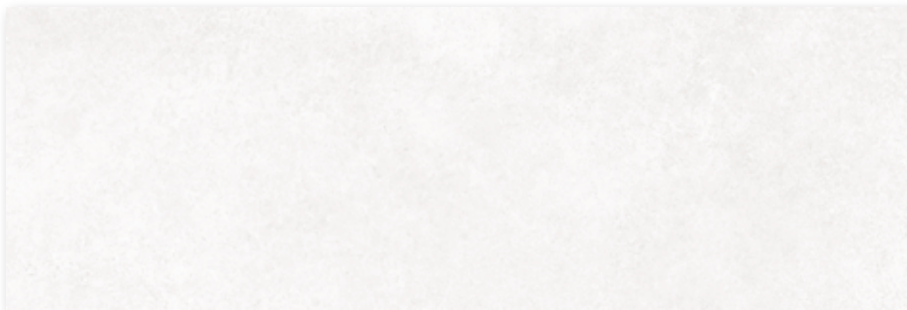

Wall tile 30 x 90 cm, 12 x 36 in, grey white, structured

## Decoration elements



Decorative tile Garden 30 x 60 cm, 12 x 24 in, green mix, structured



Decorative tile Stone 30 x 90 cm, 12 x 36 in, grey mix, structured

The decoration you have chosen is a high-quality product made of glazed earthenware. The decoration consists of different individual pictures. The connections of the individual pictures are deliberately designed freely and thus do not connect in the continuous laying. The composition of the motifs in the box may vary due to production reasons.



dark taupe

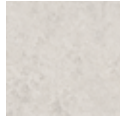

light sand



warm grey



dark anthracite



Floor tile 30 x 60 cm, 12 x 24 in, structured, R10/A+B



Floor tile 60 x 60 cm, 24 x 24 in, structured, R10/A+B



Floor tile 60 x 120 cm, 24 x 48 in, structured, R10/A+B



Floor tile 120 x 120 cm, 48 x 48 in, structured, R10/A+B



Skirting, rounded 7 x 60 cm, 2 13/16 x 24 in, structured

Mosaic 5 x 5 cm, 2 x 2 in



Mosaic sheet 30 x 30 cm, 12 x 12 in dark taupe, structured, R10/A+B



Mosaic sheet 30 x 30 cm, 12 x 12 in light sand, structured, R10/A+B

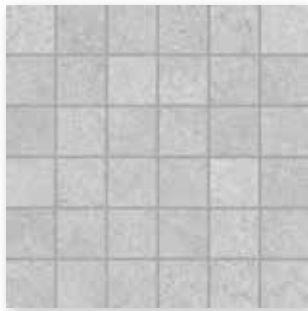

Mosaic sheet 30 x 30 cm, 12 x 12 in warm grey, structured, R10/A+B

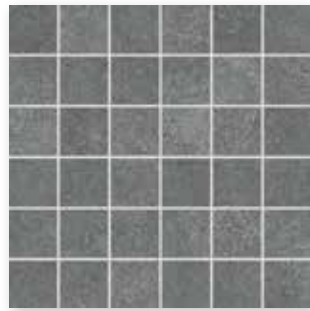

Mosaic sheet 30 x 30 cm, 12 x 12 in dark anthracite, structured, R10/A+B

Mosaic: Glass fibre net on reverse side,  
Sheet: 297 x 297 mm.

Wall Tiles

Decoration Elements<sup>2</sup>

30 x 60 cm

30 x 90 cm<sup>1</sup>

30 x 60 cm

30 x 90 cm<sup>1</sup>

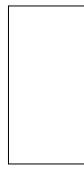

		<i>Decorative tile Garden</i>		<i>Decorative tile Stone</i>		
		<b>30 x 60 / 12 x 24</b>	<b>30 x 90 / 12 x 36</b>	<b>30 x 60 / 12 x 24</b>	<b>30 x 90 / 6 x 36</b>	Nom. dim. - cm/in
		297 x 597 x 6 mm	297 x 897 x 6 mm	297 x 597 x 6 mm	297 x 897 x 6 mm	Work size
		structured, silky-matt	structured, silky-matt	structured, stone-matt	structured, stone-matt	Surface
		5.556	3.704	5.556	3.704	m <sup>2</sup> - pieces
		10.279	10.400	10.279	10.400	m <sup>2</sup> - kg
		13	8	13	8	Bundle - pieces
		2.340	2.160	2.340	2.160	Bundle - m <sup>2</sup>
		24.050	22.464	24.050	22.464	Bundle - kg
		112.311	51.836	112.311	51.836	Pallet - m <sup>2</sup>
		1,154.400	539.136	1,154.400	539.136	Pallet - kg
		BIII	BIII	BIII	BIII	Product standard
		<b>203392H</b>	<b>323395H</b>			light taupe <input type="checkbox"/> V2
		Price gr. <b>C77</b> (m <sup>2</sup> )	Price gr. <b>C143</b> (m <sup>2</sup> )			grey white <input type="checkbox"/> V2
		<b>203393H</b>	<b>323396H</b>			green mix <input type="checkbox"/> V4
		Price gr. <b>C77</b> (m <sup>2</sup> )	Price gr. <b>C143</b> (m <sup>2</sup> )	<b>203394H</b>		grey mix <input type="checkbox"/> V4
				Price gr. <b>C89</b> (m <sup>2</sup> )		
					<b>323397H</b>	
					Price gr. <b>C149</b> (m <sup>2</sup> )	



<sup>2</sup> Decoration elements only available in full boxes.

Mosaic<sup>1/5</sup>

Floor Tiles<sup>1</sup>

Skirting, cut<sup>1</sup>

5 x 5 cm



30 x 60 cm



60 x 60 cm



60 x 120 cm<sup>3/4</sup>





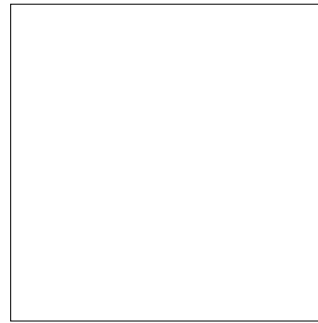

120 x 120 cm<sup>2/3/4</sup>



7 x 60 cm



Sheet: 297 x 297 mm

Nom. dim. - cm/in	5 x 5 / 2 x 2	30 x 60 / 12 x 24	60 x 60 / 24 x 24	60 x 120 / 24 x 48	120 x 120 / 48 x 48	7 x 60 / 2 13/16 x 24
Work size	47 x 47 x 6 mm	297 x 597 x 6 mm	597 x 597 x 6 mm	597 x 1197 x 6 mm	1198 x 1198 x 6 mm	70 x 597 x 6 mm
Surface	structured, matt	structured, matt	structured, matt	structured, matt	structured, matt	structured, matt
m <sup>2</sup> /m - pieces	11.111/m <sup>2</sup>	5.556/m <sup>2</sup>	2.778/m <sup>2</sup>	1.388/m <sup>2</sup>	0.694/m <sup>2</sup>	1.667/m
m <sup>2</sup> /m - kg	11.488/m <sup>2</sup>	13.273/m <sup>2</sup>	13.581/m <sup>2</sup>	14.088/m <sup>2</sup>	14.100/m <sup>2</sup>	0.938/m
Bundle - pieces	11 sheets	10	5	3	2	38
Bundle - m <sup>2</sup> /m	0.990 m <sup>2</sup>	1.800 m <sup>2</sup>	1.800 m <sup>2</sup>	2.161 m <sup>2</sup>	2.882 m <sup>2</sup>	22.795 m
Bundle - kg	11.374	23.890	24.445	30.450	40.600	21.394
Pallet - m <sup>2</sup>	35.640	71.994	64.795	75.648	69.124	
Pallet - kg	409.464	955.600	880.020	1,065.750	974.400	
Product standard	Bla	Bla	Bla	Bla	Bla	Bla
Slip resistance	R10/A+B	R10/A+B	R10/A+B	R10/A+B	R10/A+B	
Stress group	1	1	1	1	1	1
dark taupe 	<b>431328H</b> Price gr. <b>C308</b> (m <sup>2</sup> )	<b>431332H</b> Price gr. <b>C98</b> (m <sup>2</sup> )	<b>431336H</b> Price gr. <b>C107</b> (m <sup>2</sup> )	<b>431340H</b> Price gr. <b>C137</b> (m <sup>2</sup> )	<b>431344</b> Price gr. <b>C188</b> (m <sup>2</sup> )	<b>431348H</b> Price gr. <b>C437</b> (pce.)
light sand 	<b>431329H</b> Price gr. <b>C308</b> (m <sup>2</sup> )	<b>431333H</b> Price gr. <b>C98</b> (m <sup>2</sup> )	<b>431337H</b> Price gr. <b>C107</b> (m <sup>2</sup> )	<b>431341H</b> Price gr. <b>C137</b> (m <sup>2</sup> )	<b>431345</b> Price gr. <b>C188</b> (m <sup>2</sup> )	<b>431349H</b> Price gr. <b>C437</b> (pce.)
warm grey 	<b>431330H</b> Price gr. <b>C308</b> (m <sup>2</sup> )	<b>431334H</b> Price gr. <b>C98</b> (m <sup>2</sup> )	<b>431338H</b> Price gr. <b>C107</b> (m <sup>2</sup> )	<b>431342H</b> Price gr. <b>C137</b> (m <sup>2</sup> )	<b>431346</b> Price gr. <b>C188</b> (m <sup>2</sup> )	<b>431350H</b> Price gr. <b>C437</b> (pce.)
dark anthracite 	<b>431331H</b> Price gr. <b>C308</b> (m <sup>2</sup> )	<b>431335H</b> Price gr. <b>C98</b> (m <sup>2</sup> )	<b>431339H</b> Price gr. <b>C107</b> (m <sup>2</sup> )	<b>431343H</b> Price gr. <b>C137</b> (m <sup>2</sup> )	<b>431347</b> Price gr. <b>C188</b> (m <sup>2</sup> )	<b>431351H</b> Price gr. <b>C437</b> (pce.)



<sup>1</sup> without Hytect coating; with Protecta upgrading

<sup>3</sup> High weight only to carry with two persons.

<sup>4</sup> Please note: special pallet. No return, no exchange.

<sup>5</sup> Glass fibre net on reverse side



Rendering







## Natural and casual

The intended used look takes into account natural signs of wear and delicate discolorations. The wall tile is a collage of striped grains and free brush strokes. Overlays and crossings create a non-directional look which unfolds its artistic character especially in the color white – colorful.

Rendering / Architect: STELLWERK architekten, Dresden, Germany

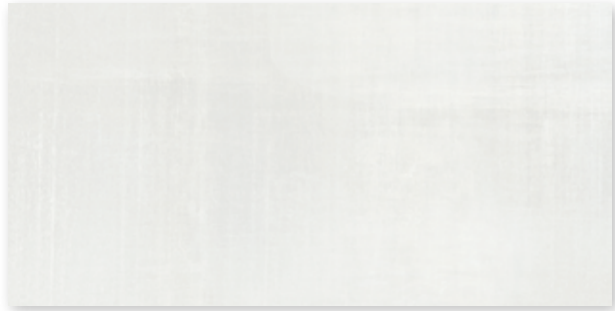

Wall tile 30 x 60 cm, 12 x 24 in, natural-white, smooth



Wall tile 30 x 60 cm, 12 x 24 in, white-colorful, smooth

## Decoration elements



Border Canvas 4 x 60 cm, 1 5/8 x 24 in, grey-black, structured

Wall Tile<sup>3</sup>

30 x 60 cm



Decoration Elements<sup>1/2/4/5</sup>

4 x 60 cm



Border Canvas

					<b>30 x 60</b> / 12 x 24	<b>4 x 60</b> / 1 5/8 x 24	Nom. dim - cm/in
					297 x 597 x 9 mm	37 x 597 x 10.5 mm	Work size
					smooth, silky-matt	structured, matt	Surface
					5.556/m <sup>2</sup>	1.667/m	m <sup>2</sup> /m - pieces
					14.946/m <sup>2</sup>	0.910/m	m <sup>2</sup> /m - kg
					9	3	Bundle - pieces
					1.620 m <sup>2</sup>	1.800 m	Bundle - m <sup>2</sup> /m
					24.210	1.638	Bundle - kg
					77.754		Pallet - m <sup>2</sup>
					1,162.080		Pallet - kg
					BIII	Bla	Product standard
					<b>282901</b>		
					Price gr. C89 (m <sup>2</sup> )		natural white <input type="checkbox"/> V2
					<b>282902</b>		
					Price gr. C89 (m <sup>2</sup> )		white-colorful <input type="checkbox"/> V4
						<b>282903</b>	
						Price gr. C437 (pce.)	grey-black <input type="checkbox"/> V3



<sup>3</sup> not frost-proof

<sup>4</sup> Only suitable for laying on the wall in indoor areas.

<sup>5</sup> Decoration elements only available in full boxes.



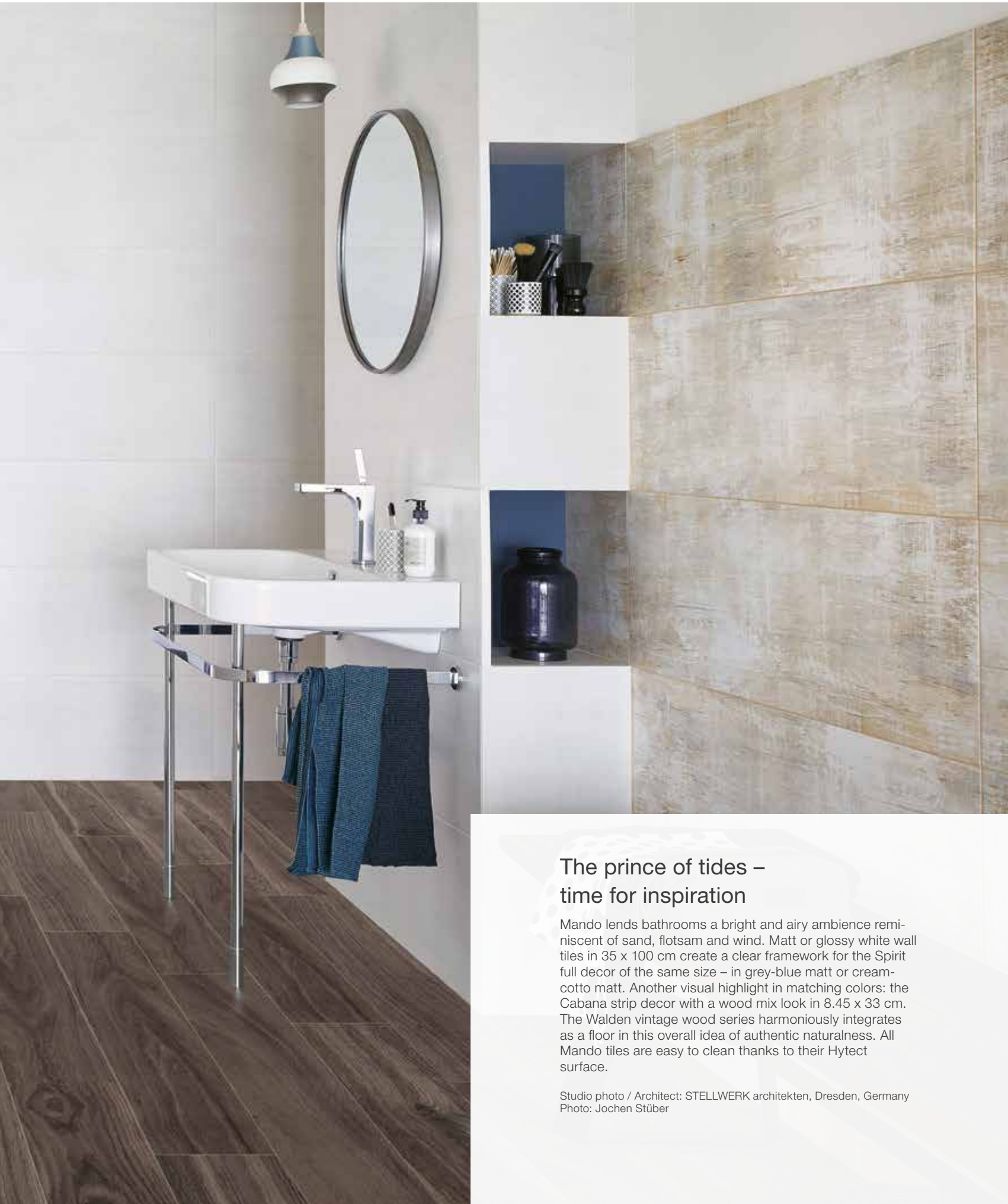

## The prince of tides – time for inspiration

Mando lends bathrooms a bright and airy ambience reminiscent of sand, flotsam and wind. Matt or glossy white wall tiles in 35 x 100 cm create a clear framework for the Spirit full decor of the same size – in grey-blue matt or cream-cotto matt. Another visual highlight in matching colors: the Cabana strip decor with a wood mix look in 8.45 x 33 cm. The Walden vintage wood series harmoniously integrates as a floor in this overall idea of authentic naturalness. All Mando tiles are easy to clean thanks to their Hytect surface.

Studio photo / Architect: STELLWERK architekten, Dresden, Germany  
Photo: Jochen Stüber



Wall tile 35 x 100 cm, 14 x 40 in, white

### Decoration elements



Decorative element Cabana 8.45 x 33 cm, 3 13/32 x 13 13/64 in, brown-mix, smooth

The Cabana strips consciously vary in terms of color. Please combine tiles from several boxes to provide a consistent appearance.



## Decoration elements



Decorative tile Spirit 35 x 100 cm, 14 x 40 in, grey-blue, smooth

## Decoration elements



Decorative tile Spirit 35 x 100 cm, 14 x 40 in, cream-cotto, smooth

Wall Tile<sup>1</sup>

Decoration Elements<sup>3</sup>

35 x 100 cm



8,45 x 33 cm<sup>2</sup>



35 x 100 cm<sup>1/4</sup>



				Decorative tile Cabana	Decorative tile Spirit		
				<b>35 x 100</b> / 14 x 40	<b>8.45 x 33</b> /313/32x1313/64	<b>35 x 100</b> / 14 x 40	Nom. dim. - cm/in
				347 x 997 x 6 mm	84.5 x 330 x 6 mm	347 x 997 x 6 mm	Work size
				smooth	smooth, silky-matt	smooth, silky-matt	Surface
				2.857/m <sup>2</sup>	3.030/m	1.000/m	m <sup>2</sup> /m - pieces
				10.108/m <sup>2</sup>	0.878/m	3.538/m	m <sup>2</sup> /m - kg
				5	18	3	Bundle - pieces
				1.750 m <sup>2</sup>	5.940 m	3.000 m	Bundle - m <sup>2</sup> /m
				17.690	5.220	10.614	Bundle - kg
				70.004			Pallet - m <sup>2</sup>
				707.600			Pallet - kg
				BIII	BIII	BIII	Product standard
				<b>363347H</b>			white glossy <input type="checkbox"/> V3
				Price gr. <b>W132</b> (m <sup>2</sup> )			white matt <input type="checkbox"/> V3
				<b>363348H</b>			brown-mix <input type="checkbox"/> V4
				Price gr. <b>W132</b> (m <sup>2</sup> )			grey-blue <input type="checkbox"/> V4
					<b>363351H</b>		cream-cotto <input type="checkbox"/> V4
					Price gr. <b>W421</b> (pce.)		
						<b>363349H</b>	
						Price gr. 3x <b>W499</b> (pce.)	
						<b>363350H</b>	
						Price gr. 3x <b>W499</b> (pce.)	



<sup>1</sup> The Cabana strips consciously vary in terms of color. Please combine tiles from several boxes to provide a consistent appearance.  
<sup>2</sup> Decoration elements only available in full boxes.  
<sup>3</sup> Set of 3 tiles





## Possibilities rich in detail

While marble is usually used in large formats, the Marble & More mosaic series captivates with its almost small-scale aesthetics and varied colorfulness. Unlike its natural marble counterpart, this tile is insensitive to aggressive media such as cleaning agents, shampoos and soaps. Slip-resistant variants extend the laying freedom of planners and architects. As Hytect tiles, Marble & More are very easy to clean and they ensure hygiene. In addition, the series is color-coordinated with the Ascona series on the floor and wall.

Rendering

Mosaic 2.5 x 2.5 cm, 3/8 x 3/8 in

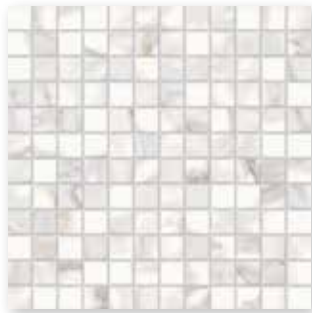

Mosaic sheet 30 x 30 cm, 12 x 12 in carrara white, smooth,  
Mosaic sheet 30 x 30 cm, 12 x 12 in carrara white, smooth, R10/B



Mosaic sheet 30 x 30 cm, 12 x 12 in illusion beige, smooth,  
Mosaic sheet 30 x 30 cm, 12 x 12 in illusion beige, smooth, R10/B

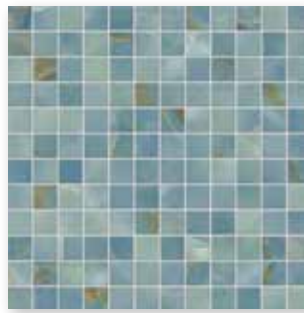

Mosaic sheet 30 x 30 cm, 12 x 12 in cielo, smooth,  
Mosaic sheet 30 x 30 cm, 12 x 12 in cielo, smooth, R10/B



Mosaic sheet 30 x 30 cm, 12 x 12 in labradorit blue, smooth,  
Mosaic sheet 30 x 30 cm, 12 x 12 in labradorit blue, smooth, R10/B



Mosaic sheet 30 x 30 cm, 12 x 12 in verde alpi, smooth,  
Mosaic sheet 30 x 30 cm, 12 x 12 in verde alpi, smooth, R10/B

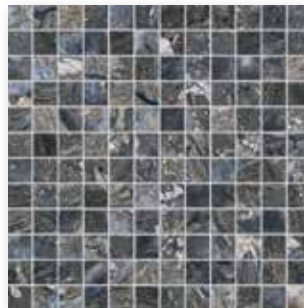

Mosaic sheet 30 x 30 cm, 12 x 12 in illusion dark, smooth,  
Mosaic sheet 30 x 30 cm, 12 x 12 in illusion dark, smooth, R10/B



Mosaics glued thermoplastically on back of Agrob Buchtal can be used not only in dry zones but also without any problems in underwater areas (e.g. swimming pools/whirlpools) as well as in permanently wet areas.



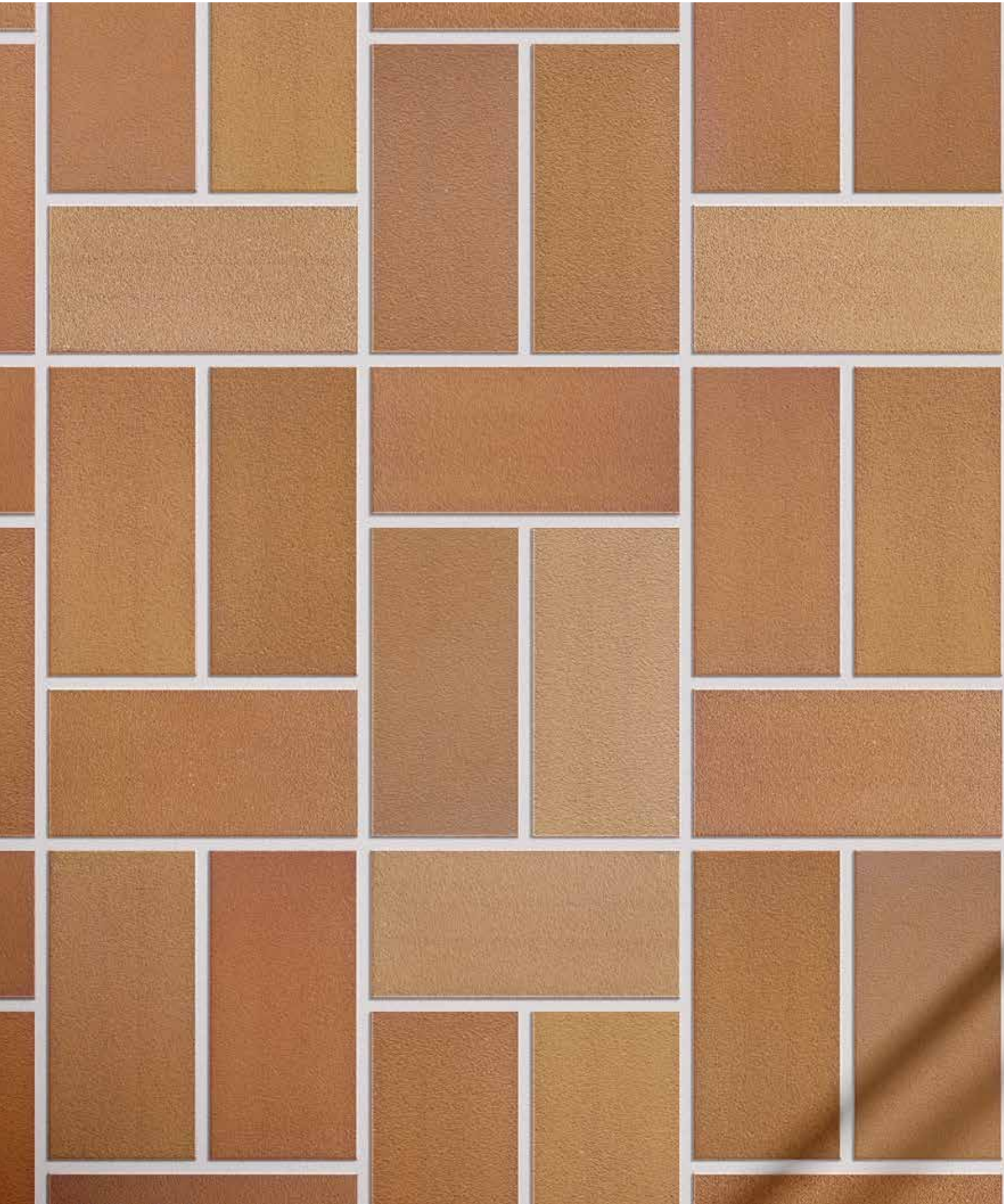



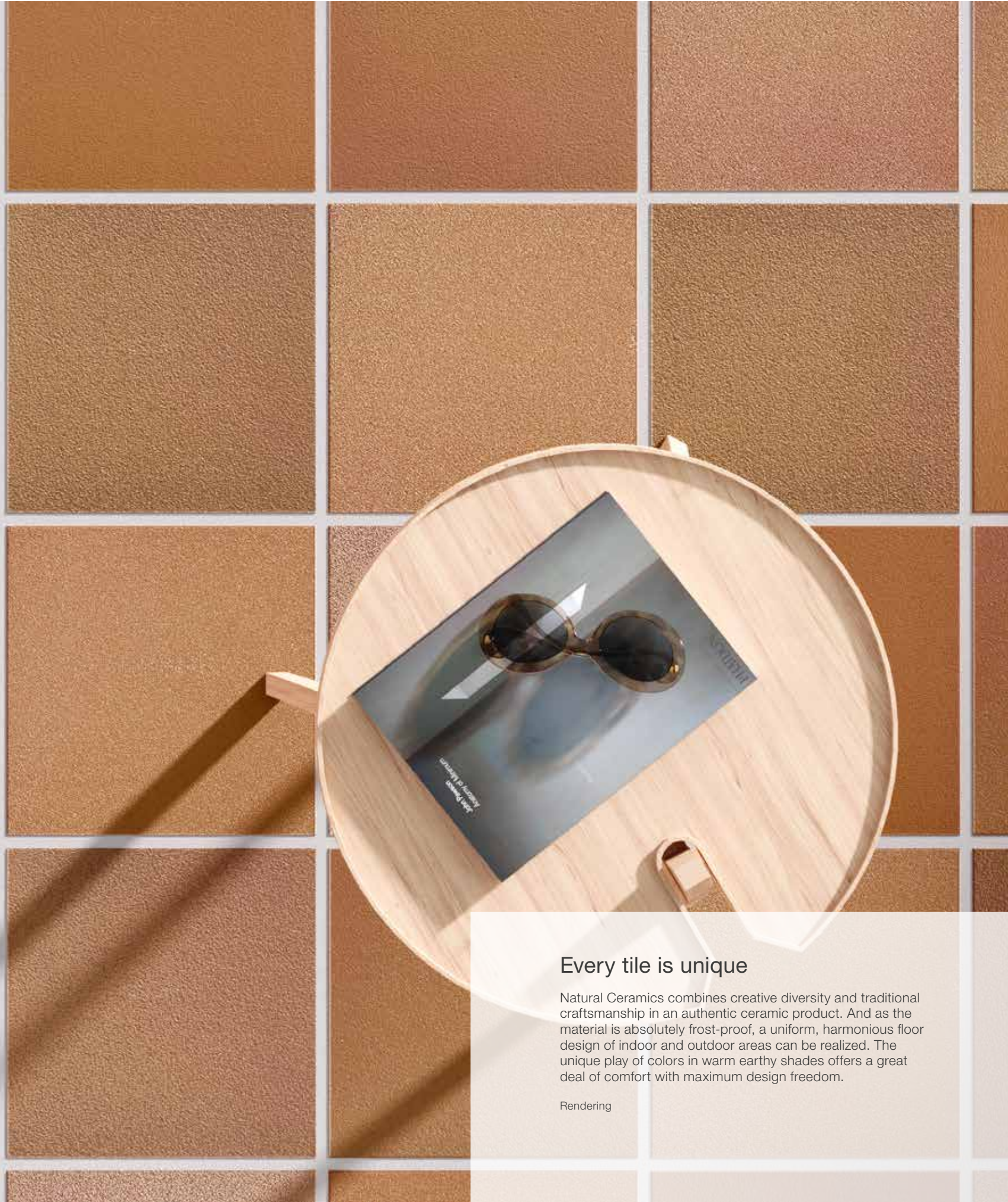

## Every tile is unique

Natural Ceramics combines creative diversity and traditional craftsmanship in an authentic ceramic product. And as the material is absolutely frost-proof, a uniform, harmonious floor design of indoor and outdoor areas can be realized. The unique play of colors in warm earthy shades offers a great deal of comfort with maximum design freedom.

Rendering



R11/A R11/B



autumn leaves



portofino



colorado-brown



Floor tile 12.5 x 25 cm, 5 x 10 in, smooth, R11/A  
Floor tile 12.5 x 25 cm, 5 x 10 in, smooth, R11/B



Floor tile 25 x 25 cm, 10 x 10 in, smooth, R11/A  
Floor tile 25 x 25 cm, 10 x 10 in, smooth, R11/B

Floor Tiles

12,5 x 25 cm



25 x 25 cm



					1010	1630	Model number
					<b>12.5 x 25</b> / 5 x 10	<b>25 x 25</b> / 10 x 10	Nom. dim. - <b>cm/in</b>
					115 x 240 x 10 mm	240 x 240 x 10 mm	Work size
					smooth, matt	smooth, matt	Surface
					33.000/m <sup>2</sup>	16.000/m <sup>2</sup>	<b>m<sup>2</sup></b> - pieces
					19.800/m <sup>2</sup>	20.160/m <sup>2</sup>	<b>m<sup>2</sup></b> - kg
					26	11	<b>Bundle</b> - pieces
					0.788 m <sup>2</sup>	0.688 m <sup>2</sup>	<b>Bundle</b> - m <sup>2</sup>
					15.600	13.860	<b>Bundle</b> - kg
					66.182	55.688	<b>Pallet</b> - m <sup>2</sup>
					1,310.400	1,122.600	<b>Pallet</b> - kg
					Alla	Alla	Product standard
					see below	see below	Slip resistance
					2	2	Stres group
					R11/B	R11/B	
					<b>010D-1010</b>	<b>010D-1630</b>	autumn leaves <input type="checkbox"/> V3
					Price gr. <b>A109</b> (m <sup>2</sup> )	Price gr. <b>A124</b> (m <sup>2</sup> )	
					R11/A	R11/A	portofino <input type="checkbox"/> V4
					<b>948D-1010</b>	<b>948D-1630</b>	
					Price gr. <b>A109</b> (m <sup>2</sup> )	Price gr. <b>A124</b> (m <sup>2</sup> )	
					R11/B	R11/B	colorado-brown <input type="checkbox"/> V4
					<b>950D-1010</b>	<b>950D-1630</b>	
					Price gr. <b>A109</b> (m <sup>2</sup> )	Price gr. <b>A124</b> (m <sup>2</sup> )	

The nosing tiles 12.5 x 25 cm can be produced with glued edge on request. The price is calculated project-specifically.







### **Endurance test: withstanding any pressure**

Floors in supermarkets should be attractive, easy to clean and extremely robust. Agrob Buchtal meets these requirements with extra thick tiles in thicknesses of up to 14 mm. With breaking strength values which are considerably higher than required by the relevant standards, the rectified large formats also withstand the loads caused by driving forklift trucks and pallet trucks without any problems. At the same time, extreme robustness is combined with an attractive look: porcelain stoneware surfaces in a wide range of colors offer all the prerequisites for a representative design.

### Design Area Pro

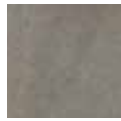

pebble



sand-white



sand-grey

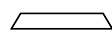

Floor tile 60 x 60 cm, 24 x 24 in, extra thick, smooth, R10

 The formats 30 x 60 cm, 12 x 24 in and 60 x 60 cm, 24 x 24 in are conically rectified.



## Design Basis Pro



concrete-grey



ash-brown



sand-beige

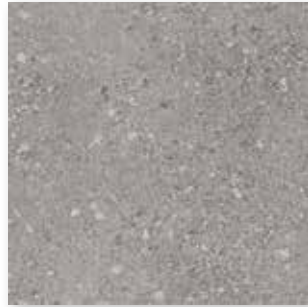

Floor tile 30 x 30 cm, 12 x 12 in, extra thick, smooth, R10



Floor tile 30 x 60 cm, 12 x 24 in, extra thick, smooth, R10

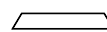

Floor tile 60 x 60 cm, 24 x 24 in, extra thick, smooth, R10

 The formats 30 x 60 cm, 12 x 24 in and 60 x 60 cm, 24 x 24 in are conically rectified.



R10



### Design Like



cement



Floor tile 60 x 60 cm, 24 x 24 in, extra thick, structured, R10

### Design Portland



anthracite



Floor tile 30 x 30 cm, 12 x 12 in, extra thick, smooth, R10

 The formats 30 x 60 cm, 12 x 24 in and 60 x 60 cm, 24 x 24 in are conically rectified.





### Design Trio



Terrazzo black



Terrazzo red



Terrazzo ivory



Floor tile 60 x 60 cm, 24 x 24 in, extra thick, smooth, R10

### Design Walden



classic oak



relax beige



smokey brown



Floor tile 30 x 60 cm, 12 x 24 in, extra thick, structured, R10

 The formats 30 x 60 cm, 12 x 24 in and 60 x 60 cm, 24 x 24 in are conically rectified.

Floor Tiles<sup>2</sup>

30 x 30 cm



30 x 30 cm



30 x 60 cm<sup>1</sup>

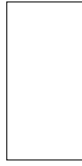

30 x 60 cm<sup>1</sup>



60 x 60 cm<sup>1</sup>

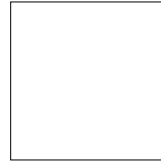

60 x 60 cm<sup>1/3</sup>



60 x 60 cm<sup>1</sup>

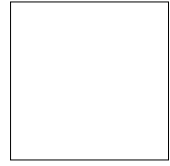

protected

	<i>Design Portland</i>	<i>Design Basis Pro</i>	<i>Design Basis Pro</i>	<i>Design Walden</i>	<i>Design Basis Pro</i>	<i>Design Area Pro</i>	<i>Design Like</i>
Nom. dim. - cm/in	<b>30 x 30</b> / 12 x 12	<b>30 x 30</b> / 12 x 12	<b>30 x 60</b> / 12 x 24	<b>30 x 60</b> / 12 x 24	<b>60 x 60</b> / 24 x 24	<b>60 x 60</b> / 24 x 24	<b>60 x 60</b> / 24 x 24
Work size	297 x 297 x 14 mm	297 x 297 x 14 mm	300 x 600 x 14 mm	300 x 600 x 14 mm	600 x 600 x 14 mm	600 x 600 x 14 mm	600 x 600 x 14 mm
Surface	smooth, matt	smooth, matt	smooth, matt	structured, matt	smooth, matt	smooth, matt	structured, matt
m <sup>2</sup> - pieces	11.337	11.337	5.589	5.589	2.778	2.778	2.778
m <sup>2</sup> - kg	32.027	32.027	32.159	32.159	31.669	31.669	31.669
Bundle - pieces	8	8	4	4	2	2	2
Bundle - m <sup>2</sup>	0.706	0.706	0.716	0.716	0.720	0.720	0.720
Bundle - kg	22.600	22.600	23.016	23.016	22.800	22.800	22.800
Pallet - m <sup>2</sup>	33.871	33.871	28.628	28.628	30.238	30.238	30.238
Pallet - kg	1,084.800	1,084.800	920.640	920.640	957.600	957.600	957.600
Product standard	Bla	Bla	Bla	Bla	Bla	Bla	Bla
Slip resistance	R10	R10	R10	R10	R10	R10	R10
Stress group	4	4	3	3	4	4	4
Portland	434194						
anthracite <input type="checkbox"/> V3							
Basis Pro		430993	430995		430977		
concrete-grey <input type="checkbox"/> V2							
Basis Pro			430996		430978		
ash-brown <input type="checkbox"/> V2							
Basis Pro			430997		430979		
sand-beige <input type="checkbox"/> V2							
Walden				432292			
classic oak <input type="checkbox"/> V2							
Walden				432293			
relax beige <input type="checkbox"/> V2							
Walden				432294			
smokey brown <input type="checkbox"/> V2							
Area Pro						430200H	
pebble <input type="checkbox"/> V2							
Area Pro						430201H	
sand-white <input type="checkbox"/> V2							
Area Pro						430202H	
sand-grey <input type="checkbox"/> V2							
Like							430684
cement <input type="checkbox"/> V2							

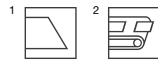

<sup>3</sup> with Hytect coating

Prices are calculated project-specifically.

Floor Tile<sup>1/2</sup>

60 x 60 cm

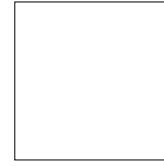

Design Trio

						<b>60 x 60 / 24 x 24</b>	Nom. dim. - <b>cm/in</b>
						600 x 600 x 14 mm	Work size
						structured, matt	Surface
						2.778	<b>m<sup>2</sup></b> - pieces
						31.669	<b>m<sup>2</sup></b> - kg
						2	<b>Bundle</b> - pieces
						0.720	<b>Bundle</b> - m <sup>2</sup>
						22.800	<b>Bundle</b> - kg
						30.238	<b>Pallet</b> - m <sup>2</sup>
						957.600	<b>Pallet</b> - kg
						Bla	Product standard
						R10	Slip resistance
						4	Stress group
						<b>431692H</b>	Trio
						<b>431693H</b>	terrazzo red <input type="checkbox"/> V4
						<b>431694H</b>	Trio
							terrazzo black <input type="checkbox"/> V4
							Trio
							terrazzo ivory <input type="checkbox"/> V4



Prices are calculated project-specifically.



Nivella levelling mat 30 x 60 cm, 12 x 24 in

## Nivella levelling mat

Nivella mats solve the problem of levelling height differences between mosaics (6.5 mm) and wall and floor tiles (8 mm). They therefore ensure a consistently even surface conveying a perfect sensation of space. Nivella is ideal for working with small-format tiles and suitable for use in both indoor and outdoor applications. Another advantage is of an acoustic nature: Nivella effectively minimizes any hollow-sounding effects. Cut to the required size, the mat is pressed fully into the tile adhesive.

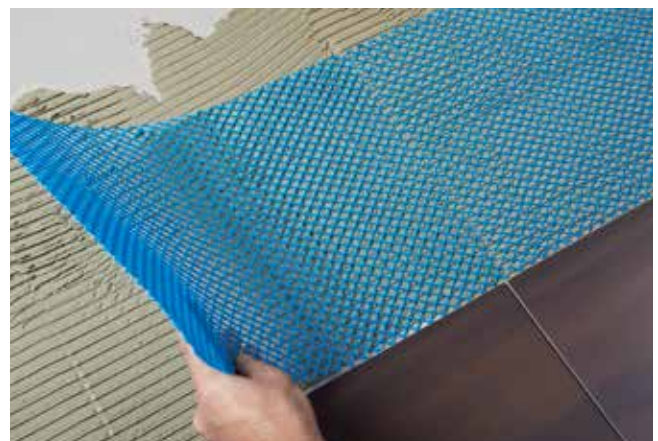

Levelling Mat

30 x 60 cm



						<b>30 x 60</b> / 12 x 24	Nom. dim. - <b>cm/in</b>
						316 x 632 x 2.5 mm	Work size
						5 sheets	Surface
						0.380	<b>m<sup>2</sup></b> - pieces
						5 sheets	<b>m<sup>2</sup></b> - kg
						1.000	<b>Bundle</b> - pieces
						0.380	<b>Bundle</b> - m <sup>2</sup>
						30.000	<b>Bundle</b> - kg
						11.400	<b>Pallet</b> - m <sup>2</sup>
							<b>Pallet</b> - kg
							Product standard
							Slip resistance
						<b>0002</b>	
						Price gr. <b>A22</b> (m <sup>2</sup> )	blue

Technical data  
 Fire class: B2  
 Load resistance: 2 KN/m<sup>2</sup> (category A1-B1)  
 Spot load for tiles in 1 x 1 cm format:  
 not greater than 0,25 KN/cm<sup>2</sup>  
 (approx. 25 kg/cm<sup>2</sup>)

Special conditions for accessories

Levelling mat for commercial and private use in indoor and outdoor applications (walls / floors)

Features:

- Levelling
- Especially under small-format coverings
- No hollow sound
- High tensile bond strength

Product description:

Nivella is a special levelling mat which is ideal for combining mosaics (6.5 mm) with the wall and floor tiles (8 mm). High tensile bond strength as well as bending, tensile and compressive strength are the distinctive performance features of this levelling mat.

Surfaces:

The surfaces on which Nivella is used must be examined for evenness, loadbearing capacity and surface strength. Differences in floor levels must be eliminated. Adhesion-inhibiting layers must be removed by grinding. Primers co-ordinated to the surface, grout and/or levelling layers must also be used.

Compensation filling and levelling – including for the adjacent coverings – must be performed prior to fitting the levelling mat. Surfaces which are sensitive to moisture must be protected by performing the appropriate sealing measures.

- Cement-based surfaces such as screed or concrete must be at least 28 days old; new screed up to 7 days after accessibility.
- Calcium sulphate screed with residual moisture < 1%
- Poured asphalt screed
- Magnesia/Stonewood screed
- Heated screed
- Dry screed
- Old, firm ceramic coverings
- Old natural stone coverings
- Plasterboard
- Fibre cement boards
- Plaster

Installation:

Apply suitable tile adhesive to the prepared surface in accordance with DIN EN 12004 C2 and DIN EN 12002 S1. Nivella mats are cut to the required size, fully embedded in the adhesive and laid edge to edge. The tile adhesive is filled consistently in the grooves (mesh structure). The mesh cavities must be 100% filled. Using the corresponding toothed bar, comb out the adhesive and lay the mosaics. At the earliest after 24 hours, the areas are grouted using a polymer-modified mortar.

Attention:

The correct and therefore successful application of our products is beyond our control. A guarantee can therefore only be given for the quality of our products within the framework of our terms and conditions governing sale and delivery but not for successful installation thereof. We retain the right to modifications representing technical progress.

Vertical payloads for ceilings to DIN 1055-3 (excerpt)				
Category	Application	Examples	Distributed load qk (kN/m <sup>2</sup> )	Point load Qk (kN)
A1	Attics	Attic space to clear height of 1.8 m	1.0	1.0
A2	Residential and recreational applications	Rooms with sufficient lateral load distribution such as rooms and corridors in residential buildings, hotel rooms and hospital wards	1.5	–
A3		As for A2 but without sufficient lateral distribution	2.0	1.0
B1	Office and working areas	Corridors in office buildings, office space, doctors' surgeries, wards, recreational rooms incl. corridors, stables	2.0	2.0



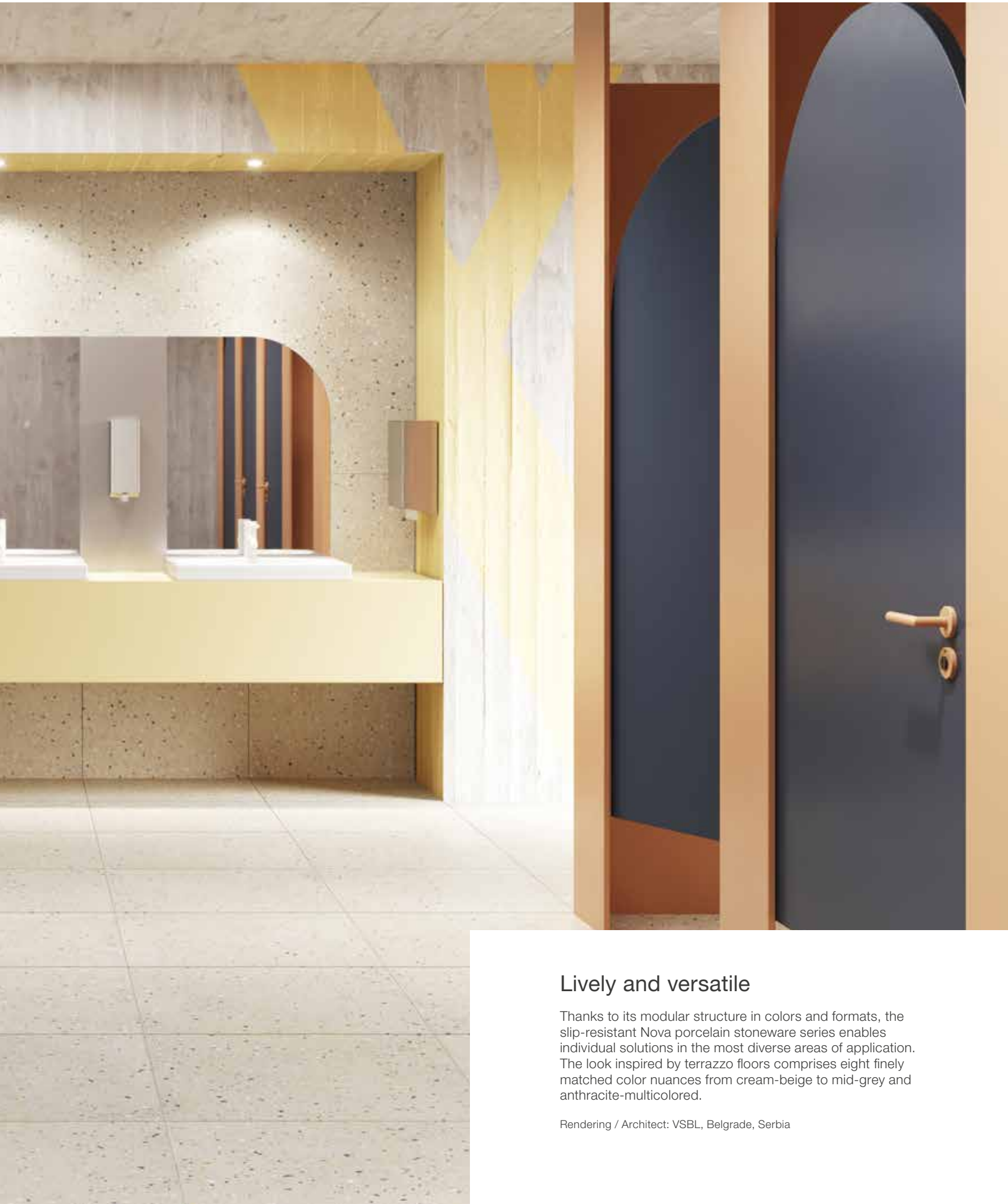

## Lively and versatile

Thanks to its modular structure in colors and formats, the slip-resistant Nova porcelain stoneware series enables individual solutions in the most diverse areas of application. The look inspired by terrazzo floors comprises eight finely matched color nuances from cream-beige to mid-grey and anthracite-multicolored.

Rendering / Architect: VSBL, Belgrade, Serbia



cream-beige



mid-brown



mid-grey



basalt



anthracite



cream-beige-multicolored



mid-grey-multicolored



anthracite-multicolored



Floor tile 15 x 15 cm, 6 x 6 in, smooth, R10/B  
Floor tile 15 x 15 cm, 6 x 6 in, smooth, R11/C



Oblong format 10 x 60 cm, 4 x 24 in, smooth, R10/A



Oblong format 15 x 60 cm, 6 x 24 in, smooth, R10/A



Floor tile 30 x 60 cm, 12 x 24 in, smooth, R10/A  
Floor tile 30 x 60 cm, 12 x 24 in, smooth, R11/B





Floor tile 60 x 60 cm, 24 x 24 in, smooth, R10/A



Floor tile 60 x 120 cm, 24 x 48 in, smooth, R10/A



R10/A R10/B



Mosaic  
5 x 5 cm, 2 x 2 in



cream-beige



anthracite



mid-brown



cream-beige-multicolored



mid-grey



mid-grey-multicolored



basalt



anthracite-multicolored



Stair tile 30 x 60 cm, 12 x 24 in (with grooves), smooth, R10/A



Mosaic sheet 30 x 30 cm, 12 x 12 in, smooth, R10/B



Cove skirting 10 x 60 cm, 4 x 24 in, smooth



Skirting, rounded 7 x 60 cm, 2 13/16 x 24 in, smooth



Stair tile with bevel 31 x 145 cm, 12 13/64 x 57 in, smooth, R10/A



Riser 28 x 145, 11.2 x 57 in, smooth

Mosaic: Glass fibre net on reverse side,  
Sheet: 297 x 297 mm

Mosaic<sup>1/3</sup>

Floor Tiles

5 x 5 cm



15 x 15 cm



15 x 15 cm



10 x 60 cm<sup>1/2</sup>



15 x 60 cm<sup>1/2</sup>



Sheet: 297 x 297 mm

Oblong format

Oblong format

	5 x 5 / 2 x 2	15 x 15 / 6 x 6	15 x 15 / 6 x 6	10 x 60 / 4 x 24	15 x 60 / 6 x 24	
	47 x 47 x 10.5 mm	147 x 147 x 8 mm	147 x 147 x 8 mm	97 x 597 x 10.5 mm	147 x 597 x 10.5 mm	Nom. dim. - cm/in
	smooth, matt	smooth, matt	smooth, matt	smooth, matt	smooth, matt	Work size
	11.111 sheets	44.444	44.444	16.667	11.111	Surface
	21.966	17.555	17.555	21.967	21.966	m <sup>2</sup> - pieces
	11 sheets	35	35	15	11	m <sup>2</sup> - kg
	0.990	0.788	0.788	0.900	0.990	Bundle - pieces
	21.747	13.825	13.825	19.770	21.747	Bundle - m <sup>2</sup>
	29.700	63.001	63.001	35.999	39.600	Bundle - kg
	652.410	1,106.000	1,106.000	790.800	869.880	Pallet - m <sup>2</sup>
	Ala	Bla	Bla	Ala	Ala	Pallet - kg
	R10/B	R10/B	R11/C	R10/A	R10/A	Product standard
	2	2	2	2	2	Slip resistance
	<b>431801H</b>	<b>431807H</b>	<b>431873H</b>	<i>431817H</i>	<i>431823H</i>	Stress group
	Price gr. <b>A286</b> (m <sup>2</sup> )	Price gr. <b>A142</b> (m <sup>2</sup> )	Price gr. <b>A157</b> (m <sup>2</sup> )	<i>Price gr. A199</i> (m <sup>2</sup> )	<i>Price gr. A199</i> (m <sup>2</sup> )	cream-beige <input type="checkbox"/> V3
	<b>431802H</b>	<b>431808H</b>	<b>431874H</b>	<i>431818H</i>	<i>431824H</i>	mid-brown <input type="checkbox"/> V3
	Price gr. <b>A286</b> (m <sup>2</sup> )	Price gr. <b>A142</b> (m <sup>2</sup> )	Price gr. <b>A157</b> (m <sup>2</sup> )	<i>Price gr. A199</i> (m <sup>2</sup> )	<i>Price gr. A199</i> (m <sup>2</sup> )	
	<b>431803H</b>	<b>431809H</b>	<b>431875H</b>	<i>431819H</i>	<i>431825H</i>	medium grey <input type="checkbox"/> V3
	Price gr. <b>A286</b> (m <sup>2</sup> )	Price gr. <b>A142</b> (m <sup>2</sup> )	Price gr. <b>A157</b> (m <sup>2</sup> )	<i>Price gr. A199</i> (m <sup>2</sup> )	<i>Price gr. A199</i> (m <sup>2</sup> )	
	<b>431804H</b>	<b>431810H</b>	<b>431876H</b>	<i>431820H</i>	<i>431826H</i>	basalt <input type="checkbox"/> V3
	Price gr. <b>A286</b> (m <sup>2</sup> )	Price gr. <b>A142</b> (m <sup>2</sup> )	Price gr. <b>A157</b> (m <sup>2</sup> )	<i>Price gr. A199</i> (m <sup>2</sup> )	<i>Price gr. A199</i> (m <sup>2</sup> )	
	<b>431805H</b>	<b>431811H</b>	<b>431877H</b>	<i>431821H</i>	<i>431827H</i>	anthracite <input type="checkbox"/> V3
	Price gr. <b>A286</b> (m <sup>2</sup> )	Price gr. <b>A142</b> (m <sup>2</sup> )	Price gr. <b>A157</b> (m <sup>2</sup> )	<i>Price gr. A199</i> (m <sup>2</sup> )	<i>Price gr. A199</i> (m <sup>2</sup> )	
	<b>431744H</b>			<i>431746H</i>	<i>431748H</i>	cream-beige <input type="checkbox"/> V4
	Price gr. <b>A286</b> (m <sup>2</sup> )			<i>Price gr. A199</i> (m <sup>2</sup> )	<i>Price gr. A199</i> (m <sup>2</sup> )	multicolored <input type="checkbox"/> V4
	<b>431745H</b>			<i>431747H</i>	<i>431749H</i>	mid-grey <input type="checkbox"/> V4
	Price gr. <b>A286</b> (m <sup>2</sup> )			<i>Price gr. A199</i> (m <sup>2</sup> )	<i>Price gr. A199</i> (m <sup>2</sup> )	multicolored <input type="checkbox"/> V4
	<b>431806H</b>			<i>431822H</i>	<i>431828H</i>	anthracite <input type="checkbox"/> V4
	Price gr. <b>A286</b> (m <sup>2</sup> )			<i>Price gr. A199</i> (m <sup>2</sup> )	<i>Price gr. A199</i> (m <sup>2</sup> )	multicolored <input type="checkbox"/> V4



<sup>3</sup> Glass fibre net on reverse side



Floor Tiles<sup>1</sup>

30 x 60 cm



30 x 60 cm

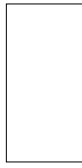











60 x 60 cm<sup>2</sup>



60 x 120 cm<sup>2</sup>



Nom. dim. - cm/in	30 x 60 / 12 x 24	30 x 60 / 12 x 24	60 x 60 / 24 x 24	60 x 120 / 24 x 48			
Work size	297 x 597 x 10.5 mm	297 x 597 x 10.5 mm	597 x 597 x 10.5 mm	597 x 1197 x 10.5 mm			
Surface	smooth, matt	smooth, matt	smooth, matt	smooth, matt			
m <sup>2</sup> - pieces	5.556	5.556	2.778	1.388			
m <sup>2</sup> - kg	21.974	21.974	21.996	21.996			
Bundle - pieces	6	6	3	2			
Bundle - m <sup>2</sup>	1.080	1.080	1.080	1.441			
Bundle - kg	23.730	23.730	23.754	31.672			
Pallet - m <sup>2</sup>	43.197	43.197	32.397	30.259			
Pallet - kg	949.200	949.200	712.620	665.112			
Product standard	Ala	Ala	Ala	Ala			
Slip resistance	R10/A	R11/B	R10/A	R10/A			
Stress group	2	2	2	2			
cream-beige 	<b>431829H</b> Price gr. <b>A121</b> (m <sup>2</sup> )	<b>431835H</b> Price gr. <b>A154</b> (m <sup>2</sup> )	<b>431840H</b> Price gr. <b>A136</b> (m <sup>2</sup> )	<b>431846H</b> Price gr. <b>A154</b> (m <sup>2</sup> )			
mid-brown 	<b>431830H</b> Price gr. <b>A121</b> (m <sup>2</sup> )	<b>431836H</b> Price gr. <b>A154</b> (m <sup>2</sup> )	<b>431841H</b> Price gr. <b>A136</b> (m <sup>2</sup> )	<b>431847H</b> Price gr. <b>A154</b> (m <sup>2</sup> )			
medium grey 	<b>431831H</b> Price gr. <b>A121</b> (m <sup>2</sup> )	<b>431837H</b> Price gr. <b>A154</b> (m <sup>2</sup> )	<b>431842H</b> Price gr. <b>A136</b> (m <sup>2</sup> )	<b>431848H</b> Price gr. <b>A154</b> (m <sup>2</sup> )			
basalt 	<b>431832H</b> Price gr. <b>A121</b> (m <sup>2</sup> )	<b>431838H</b> Price gr. <b>A154</b> (m <sup>2</sup> )	<b>431843H</b> Price gr. <b>A136</b> (m <sup>2</sup> )	<b>431849H</b> Price gr. <b>A154</b> (m <sup>2</sup> )			
anthracite 	<b>431833H</b> Price gr. <b>A121</b> (m <sup>2</sup> )	<b>431839H</b> Price gr. <b>A154</b> (m <sup>2</sup> )	<b>431844H</b> Price gr. <b>A136</b> (m <sup>2</sup> )	<b>431850H</b> Price gr. <b>A154</b> (m <sup>2</sup> )			
cream-beige 	<b>431750H</b> Price gr. <b>A121</b> (m <sup>2</sup> )		<b>431752H</b> Price gr. <b>A136</b> (m <sup>2</sup> )	<b>431754H</b> Price gr. <b>A154</b> (m <sup>2</sup> )			
multicolored 	<b>431751H</b> Price gr. <b>A121</b> (m <sup>2</sup> )		<b>431753H</b> Price gr. <b>A136</b> (m <sup>2</sup> )	<b>431755H</b> Price gr. <b>A154</b> (m <sup>2</sup> )			
mid-grey 	<b>431834H</b> Price gr. <b>A121</b> (m <sup>2</sup> )		<b>431845H</b> Price gr. <b>A136</b> (m <sup>2</sup> )	<b>431851H</b> Price gr. <b>A154</b> (m <sup>2</sup> )			
anthracite 							
multicolored 							



<sup>2</sup> High weight only to carry with two persons.

Stair Tile<sup>2/4</sup>

Stair Tile with Bevel<sup>2/3/4</sup>

Riser<sup>2/3/4</sup>

Skirting, rounded<sup>1</sup>

Cove Skirting, decorated<sup>1/2/5</sup>

30 x 60 cm

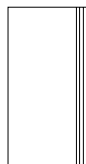

31 x 145 cm



28 x 145 cm



7 x 60 cm



10 x 60 cm



	30 x 60 / 12 x 24	31 x 145 / 12 13/64 x 57	28 x 145 / 11 x 57	7 x 60 / 2 13/16 x 24	10 x 60 / 4 x 24	Nom. dim. - cm/in
	297 x 597 x 10.5 mm	307 x 1447 x 10.5 mm	280 x 1447 x 10.5 mm	70 x 597 x 10.5 mm	100 x 597/35 x 9 mm	Work size
	smooth, matt	smooth, matt	smooth, matt	smooth, matt	smooth, matt	Surface
	1.667	0.690	0.690	1.667	1.667	m - pieces
	6.593	7.480	6.716	1.554	2.000	m - kg
	6	2	2	15	20	Bundle - pieces
	3.599 m	2.899 m	2.899 m	8.998	11.998	Bundle - m <sup>2</sup> /m
	23.730	21.682	19.466	13.980	24.000	Bundle - kg
						Pallet - m <sup>2</sup>
						Pallet - kg
	Ala	Ala	Ala	Ala	Alb	Product standard
	R10/A	R10/A	R10/A			Slip resistance
	2	2	2			Stress group
	431852H	431797H	431785H	431864H	431887H	cream-beige <input type="checkbox"/> V3
	Price gr. A475 (pce.)	Price gr. A560 (pce.)	Price gr. A528 (pce.)	Price gr. A438 (pce.)	Price gr. A445 (pce.)	
	431853H	431715H	431719H	431865H	431893H	mid-brown <input type="checkbox"/> V3
	Price gr. A475 (pce.)	Price gr. A560 (pce.)	Price gr. A528 (pce.)	Price gr. A438 (pce.)	Price gr. A445 (pce.)	
	431854H	431736H	431765H	431866H	431894H	medium grey <input type="checkbox"/> V3
	Price gr. A475 (pce.)	Price gr. A560 (pce.)	Price gr. A528 (pce.)	Price gr. A438 (pce.)	Price gr. A445 (pce.)	
	431855H	431794H	431727H	431867H	431786H	basalt <input type="checkbox"/> V3
	Price gr. A475 (pce.)	Price gr. A560 (pce.)	Price gr. A528 (pce.)	Price gr. A438 (pce.)	Price gr. A445 (pce.)	
	431856H	430599H	431720H	431868H	431787H	anthracite <input type="checkbox"/> V3
	Price gr. A475 (pce.)	Price gr. A560 (pce.)	Price gr. A528 (pce.)	Price gr. A438 (pce.)	Price gr. A445 (pce.)	
	431756H	431716H	431721H	431762H		cream-beige <input type="checkbox"/> V4
	Price gr. A475 (pce.)	Price gr. A560 (pce.)	Price gr. A528 (pce.)	Price gr. A438 (pce.)		
	431757H	431717H	431722H	431763H		mid-grey <input type="checkbox"/> V4
	Price gr. A475 (pce.)	Price gr. A560 (pce.)	Price gr. A528 (pce.)	Price gr. A438 (pce.)		
	431857H	431718H	431723H	431869H		multicolored <input type="checkbox"/> V4
	Price gr. A475 (pce.)	Price gr. A560 (pce.)	Price gr. A528 (pce.)	Price gr. A438 (pce.)		
						anthracite <input type="checkbox"/> V4
						multicolored <input type="checkbox"/> V4



<sup>1</sup> Rectified only on the two short sides. The long side can not be rectified.

<sup>2</sup> For details, refer to page 538. For more solutions concerning stair design, refer to the series Area Pro.

<sup>3</sup> Color deviations compared to the adjoining covering due to production are no reason for complaint in case of horizontal laying.

310 Oak





## Easy-care wood look

Oak achieves an elegant and refined wood look – both in the natural and the anthracite variant. The floor series offers 5 different sizes, stair elements, skirtings and a hexagonal floor décor in 30 x 35 cm – all of them with Hytect surface – for plenty of design freedom with a uniform look. A modern touch is provided by three panel formats measuring 30 x 120, 40 x 120 and 60 x 120 cm. These large formats show the grain to its best advantage.

Studiophoto



natural oak



oak anthracite



Floor tile 15 x 90 cm, 6 x 36 in, structured, R10/A



Floor tile 30 x 90 cm, 12 x 36 in, structured, R10/A



Floor tile 30 x 120 cm, 12 x 48 in, structured, R10/A



Floor tile 40 x 120 cm, 16 x 48 in, structured, R10/A





Floor tile 60 x 120 cm, 24 x 48 in, structured, R10/A



Stair tile 30 x 120 cm, 12 x 48 in (with grooves), structured, R10/A



Skirting, rounded 6 x 60 cm, 2 3/8 x 24 in, structured

## Decoration elements



Decorative tile Hexagon 30 x 35 cm, 12 x 14 in, natural oak, structured, R10/A



Decorative tile Hexagon 30 x 35 cm, 12 x 14 in, anthracite oak, structured, R10/A

Glass fibre net on reverse side,  
Sheet: 298 x 344.1 mm.

Decoration Elements<sup>3</sup>

30 x 35 cm



Decorative tile Hexagon  
Sheet: 298 x 344,1 mm



Nom. dim. - cm/in	<b>30 x 35</b> / 12 x 14						
Work size	298 x 344.1 x 8 mm						
Surface	structured, matt						
m - pieces	3.333						
m - kg	4.166						
Bundle - pieces	3						
Bundle - m	0.900						
Bundle - kg	3.750						
Product standard	Alb						
Slip resistance	R10/A						
Stress group	2						
natural oak <input type="checkbox"/> V4	<b>8471-B698HK</b> Price gr. <b>W518</b> (pce.)						
anthracite oak <input type="checkbox"/> V3	<b>8472-B698HK</b> Price gr. <b>W518</b> (pce.)						



Floor Tiles<sup>1</sup>

Stair Tile<sup>1/2</sup>

Skirting, rounded<sup>1</sup>

15 x 90 cm<sup>2</sup>



30 x 90 cm

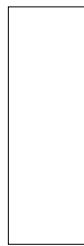

30 x 120 cm



40 x 120 cm



60 x 120 cm<sup>4</sup>



30 x 120 cm



6 x 60 cm



Nom. dim. - cm/in	<b>15 x 90</b> / 6 x 36	<b>30 x 90</b> / 12 x 36	<b>30 x 120</b> / 12 x 48	<b>40 x 120</b> / 16 x 48	<b>60 x 120</b> / 24 x 48	<b>30 x 120</b> / 12 x 48	<b>6 x 60</b> / 2 3/8 x 24
Work size	147 x 897 x 8 mm	297 x 897 x 8 mm	297 x 1197 x 8 mm	397 x 1197 x 8 mm	597 x 1197 x 8 mm	297 x 1197 x 8 mm	60 x 597 x 8 mm
Surface	structured, matt	structured, matt	structured, matt	structured, matt	structured, matt	structured, matt	structured, matt
m <sup>2</sup> /m - pieces	7.407/m <sup>2</sup>	3.704/m <sup>2</sup>	2.778/m <sup>2</sup>	2.083/m <sup>2</sup>	1.388/m <sup>2</sup>	0.833/m	1.667/m
m <sup>2</sup> /m - kg	17.495/m <sup>2</sup>	17.501/m <sup>2</sup>	17.501/m <sup>2</sup>	17.497/m <sup>2</sup>	17.489/m <sup>2</sup>	5.248/m	1.100/m
Bundle - pieces	8	5	4	3	2	4	27
Bundle - m <sup>2</sup> /m	1.080 m <sup>2</sup>	1.350 m <sup>2</sup>	1.440 m <sup>2</sup>	1.440 m <sup>2</sup>	1.441 m <sup>2</sup>	4.802 m	16.197 m
Bundle - kg	18.896	23.625	25.200	25.200	25.200	25.200	17.820
Pallet - m <sup>2</sup>	43.202	40.497	43.197	51.848	36.023		
Pallet - kg	755.840	708.750	756.000	907.200	630.000		
Product standard	Alb	Alb	Alb	Alb	Alb	Alb	Alb
Slip resistance	R10/A	R10/A	R10/A	R10/A	R10/A	R10/A	
Stress group	2	2	2	2	2	2	
natural oak <input type="checkbox"/> V4	<b>8471-B695HK</b> Price gr. <b>W171</b> (m <sup>2</sup> )	<b>8471-B690HK</b> Price gr. <b>W162</b> (m <sup>2</sup> )	<b>8471-B620HK</b> Price gr. <b>W171</b> (m <sup>2</sup> )	<b>8471-B660HK</b> Price gr. <b>W171</b> (m <sup>2</sup> )	<b>8471-B670HK</b> Price gr. <b>W171</b> (m <sup>2</sup> )	<b>8471-B629HK</b> Price gr. <b>W559</b> (pce.)	<b>8471-B610HK</b> Price gr. <b>W439</b> (pce.)
anthracite oak <input type="checkbox"/> V3	<b>8472-B695HK</b> Price gr. <b>W171</b> (m <sup>2</sup> )	<b>8472-B690HK</b> Price gr. <b>W162</b> (m <sup>2</sup> )	<b>8472-B620HK</b> Price gr. <b>W171</b> (m <sup>2</sup> )	<b>8472-B660HK</b> Price gr. <b>W171</b> (m <sup>2</sup> )	<b>8472-B670HK</b> Price gr. <b>W171</b> (m <sup>2</sup> )	<b>8472-B629HK</b> Price gr. <b>W559</b> (pce.)	<b>8472-B610HK</b> Price gr. <b>W439</b> (pce.)



<sup>3</sup> Decoration elements only available in full boxes.

<sup>4</sup> High weight only to carry with two persons.

Studio photo







## Sea of colors

The Ocean series offers a diverse color range for pools, spas and wellness areas, which reflects the element of water in all its vibrancy. Delicate cloud and fine-grained structures blend with the shimmer of the sun reflections. By means of digital printing and glaze pigments, iridescent colors such as crystal-clear green, caribbean turquoise or deep blue are created. The formats in oblong and mosaic look are suitable for atmospheric and functional pool designs and perfectly complement series such as ChromaPlural.

Rendering

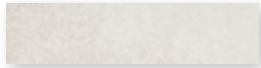

Wall tile 6.2 x 25 cm, 2 1/2 x 10 in  
sunset beige, smooth



Wall tile 6.2 x 25 cm, 2 1/2 x 10 in  
wave blue, smooth

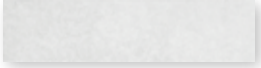

Wall tile 6.2 x 25 cm, 2 1/2 x 10 in  
cliff white, smooth



Wall tile 6.2 x 25 cm, 2 1/2 x 10 in  
atlantic blue, smooth

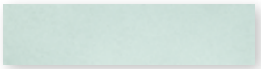

Wall tile 6.2 x 25 cm, 2 1/2 x 10 in  
crystal green, smooth



Wall tile 6.2 x 25 cm, 2 1/2 x 10 in  
pacific blue, smooth



Wall tile 6.2 x 25 cm, 2 1/2 x 10 in  
island green, smooth



Wall tile 6.2 x 25 cm, 2 1/2 x 10 in  
moos green, smooth

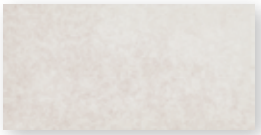

Wall tile 12.5 x 25 cm, 5 x 10 in  
sunset beige, smooth



Wall tile 12.5 x 25 cm, 5 x 10 in  
wave blue, smooth

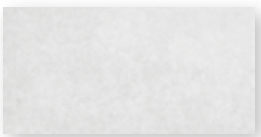

Wall tile 12.5 x 25 cm, 5 x 10 in  
cliff white, smooth



Wall tile 12.5 x 25 cm, 5 x 10 in  
atlantic blue, smooth

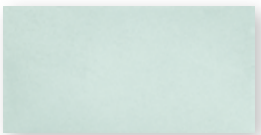

Wall tile 12.5 x 25 cm, 5 x 10 in  
crystal green, smooth



Wall tile 12.5 x 25 cm, 5 x 10 in  
pacific blue, smooth



Wall tile 12.5 x 25 cm, 5 x 10 in  
island green, smooth



Wall tile 12.5 x 25 cm, 5 x 10 in  
moos green, smooth



R10/B



Mosaic 2.5 x 2.5 cm, 1 x 1 in



Mosaic sheet 30 x 30 cm, 12 x 12 in seaside beige, structured,  
Mosaic sheet 30 x 30 cm, 12 x 12 in seaside beige, structured, R10/B

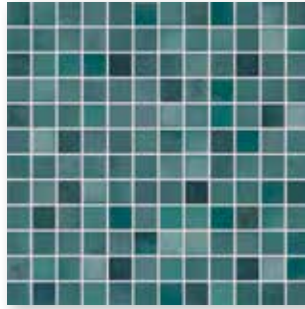

Mosaic sheet 30 x 30 cm, 12 x 12 in caribic blue, structured,  
Mosaic sheet 30 x 30 cm, 12 x 12 in caribic blue, structured, R10/B

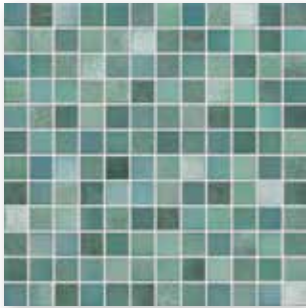

Mosaic sheet 30 x 30 cm, 12 x 12 in ocean green, structured,  
Mosaic sheet 30 x 30 cm, 12 x 12 in ocean green, structured, R10/B



Mosaic sheet 30 x 30 cm, 12 x 12 in deep sea blue, structured,  
Mosaic sheet 30 x 30 cm, 12 x 12 in deep sea blue, structured, R10/B



Mosaics glued thermoplastically on back of Agrob Buchtal can be used not only in dry zones but also without any problems in underwater areas (e.g. swimming pools/whirlpools) as well as in permanently wet areas (e.g. pool surrounds/showers).

Mosaic - joint 3 mm<sup>1</sup>

Wall Tiles - joint 6 mm

2,5 x 2,5 cm



2,5 x 2,5 cm



6,2 x 25 cm<sup>2</sup>



12,5 x 25 cm



Sheet 297 x 297 cm

Sheet 297 x 297 cm

Nom. dim. - cm/in	<b>2.5 x 2.5 / 1 x 1</b>	<b>2.5 x 2.5 / 1 x 1</b>	<b>6.2 x 25 / 2 1/2 x 10</b>	<b>12.5 x 25 / 5 x 10</b>			
Work size	23 x 23 x 6.5 mm	23 x 23 x 6.5 mm	56 x 244 x 6 mm	119 x 244 x 6 mm			
Surface	structured, glossy	structured, matt	smooth, glossy	smooth, glossy			
m <sup>2</sup> - pieces	11 sheets	11 sheets	64.000	32.000			
m <sup>2</sup> - kg	12.100	12.100	10.880	12.160			
Bundle - pieces	11 sheets	11 sheets	88	44			
Bundle - m <sup>2</sup>	1.000	1.000	1.375	1.375			
Bundle - kg	12.100	12.100	14.960	16.720			
Pallet - m <sup>2</sup>	48.000	48.000	132.000	115.500			
Pallet - kg	580.800	580.800	1,436.160	1,404.480			
Product standard	Blb	Blb	Alb	Alb			
Slip resistance		R10/B					
Stress group	1	1					
seaside beige <input type="checkbox"/>	<b>436220H</b> Price gr. <b>A250</b> (m <sup>2</sup> )	<b>436224H</b> Price gr. <b>A259</b> (m <sup>2</sup> )					
ocean green <input type="checkbox"/>	<b>436221H</b> Price gr. <b>A250</b> (m <sup>2</sup> )	<b>436225H</b> Price gr. <b>A259</b> (m <sup>2</sup> )					
caribic blue <input type="checkbox"/>	<b>436222H</b> Price gr. <b>A250</b> (m <sup>2</sup> )	<b>436226H</b> Price gr. <b>A259</b> (m <sup>2</sup> )					
deep sea blue <input type="checkbox"/>	<b>436223H</b> Price gr. <b>A250</b> (m <sup>2</sup> )	<b>436227H</b> Price gr. <b>A259</b> (m <sup>2</sup> )					
sunset beige <input type="checkbox"/>			<b>436228H</b> Price gr. <b>A175</b> (m <sup>2</sup> )	<b>436236H</b> Price gr. <b>A175</b> (m <sup>2</sup> )			
cliff white <input type="checkbox"/>			<b>436229H</b> Price gr. <b>A175</b> (m <sup>2</sup> )	<b>436237H</b> Price gr. <b>A175</b> (m <sup>2</sup> )			
crystal green <input type="checkbox"/>			<b>436230H</b> Price gr. <b>A175</b> (m <sup>2</sup> )	<b>436238H</b> Price gr. <b>A175</b> (m <sup>2</sup> )			
island green <input type="checkbox"/>			<b>436231H</b> Price gr. <b>A175</b> (m <sup>2</sup> )	<b>436239H</b> Price gr. <b>A175</b> (m <sup>2</sup> )			
wave blue <input type="checkbox"/>			<b>436232H</b> Price gr. <b>A175</b> (m <sup>2</sup> )	<b>436240H</b> Price gr. <b>A175</b> (m <sup>2</sup> )			
atlantic blue <input type="checkbox"/>			<b>436233H</b> Price gr. <b>A175</b> (m <sup>2</sup> )	<b>436241H</b> Price gr. <b>A175</b> (m <sup>2</sup> )			
pacific blue <input type="checkbox"/>			<b>436234H</b> Price gr. <b>A175</b> (m <sup>2</sup> )	<b>436242H</b> Price gr. <b>A175</b> (m <sup>2</sup> )			
moos green <input type="checkbox"/>			<b>436235H</b> Price gr. <b>A175</b> (m <sup>2</sup> )	<b>436243H</b> Price gr. <b>A175</b> (m <sup>2</sup> )			



<sup>2</sup> Supplied as double-tiles; to be broken by customer.

The series Ocean will be available as of the 2nd quarter of 2025.



Rendering







## With a breath of nostalgia

Experiencing original ideas anew, playfully combining motifs indoors and outdoors: with additional patterns and individual decorative elements, the “vintage modular system” of the series PATTERN provides an extensive range of products and perfectly fits into any living style. The Vanda decorative element offers a mix of 12 different floral and geometric motifs. The floral Isola decorative element and the geometric Baleno decorative element are ideal as individual motifs. Thanks to their delicate color compositions, each of the three decorative variants harmonizes with the basic tile in cement-grey. However, they can also be arranged to form larger motifs – or even a ceramic “carpet”.

Rendering / Architect: STELLWERK architekten, Dresden, Germany



Mosaic 2.5 x 2.5 cm, 1 x 1 in



Mosaic sheet Vola 30 x 30 cm, 12 x 12 in, multicolored, smooth



Mosaic sheet Vola 30 x 30 cm, 12 x 12 in, beige-brown, smooth



Mosaic sheet Vola 30 x 30 cm, 12 x 12 in, grey, smooth

Mosaic 5 x 5 cm, 2 x 2 in



Mosaic sheet Vola 30 x 30 cm, 12 x 12 in, multicolored, smooth, R10/B

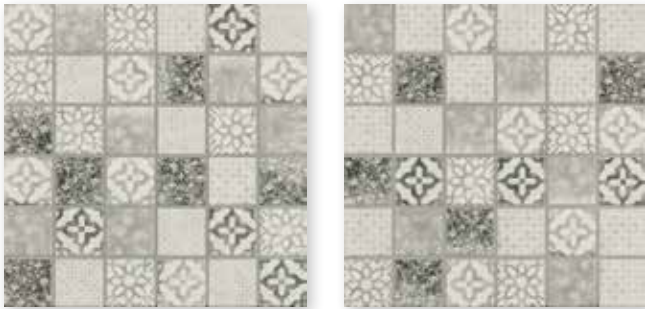

Mosaic sheet Vola 30 x 30 cm, 12 x 12 in, grey, smooth, R10/B



Mosaic sheet Ornamenta 30 x 30 cm, 12 x 12 in, blue, smooth



Mosaic sheet Ornamenta 30 x 30 cm, 12 x 12 in, multicolor, smooth

The Ornamenta decorations are color-coordinated with the decorative elements of the Trio series: Color and Lines (see page 472 and the following).



Mosaics glued thermoplastically on back of Agrob Buchtal can be used not only in dry zones but also without any problems in underwater areas (e.g. swimming pools/whirlpools) as well as in permanently wet areas.

The articles Vola, Mesh and Ornamenta each depict different motifs. Arrangement and packing are random and arbitrary.

Mosaic 10 x 10 cm, 4 x 4 in



Mosaic sheet Vola 30 x 30 cm, 12 x 12 in, multicolored, smooth



Mosaic sheet Mesh 30 x 30 cm, 12 x 12 in, natural-mix, smooth

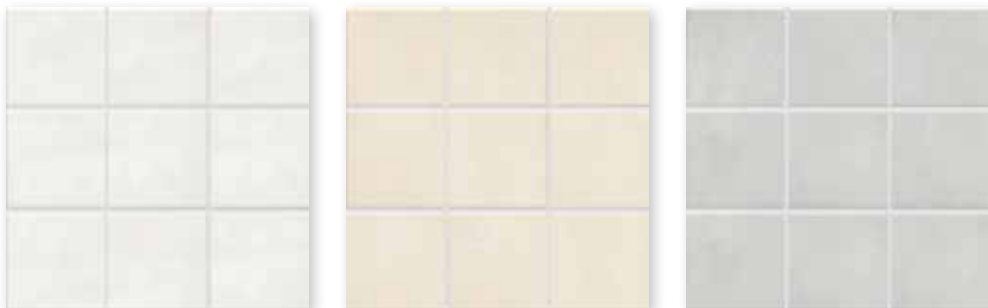

Mosaic sheet 30 x 30 cm, 12 x 12 in white, smooth

Mosaic sheet 30 x 30 cm, 12 x 12 in beige, smooth

Mosaic sheet 30 x 30 cm, 12 x 12 in grey, smooth



Mosaics glued thermoplastically on back of Agrob Buchtal can be used not only in dry zones but also without any problems in underwater areas (e.g. swimming pools/whirlpools) as well as in permanently wet areas.



Wall/floor tile Ornamenta 15 x 15 cm, 6 x 6 in, blue, smooth



Wall/floor tile Ornamenta 15 x 15 cm, 6 x 6 in, multicolor, smooth

The Ornamenta decorations are color-coordinated with the decorative elements of the Trio series: Color and Lines (see page 472 and the following).

The articles Vola, Mesh and Ornamenta each depict different motifs. Arrangement and packing are random and arbitrary.



Wall/floor tile Vola 20 x 20 cm, 8 x 8 in, multicolored, smooth



Wall/floor tile Vola 20 x 20 cm, 8 x 8 in, grey, smooth

The articles Vola and Salina each depict different motifs. Arrangement and packing are random and arbitrary.





Wall/floor tile Salina 20 x 20 cm, 8 x 8 in, multicolored, smooth



Individual motif Nelas  
20 x 20 cm, 8 x 8 in,  
black-white, smooth



Individual motif Mellby  
20 x 20 cm, 8 x 8 in, grey,  
smooth



Wall/floor tile  
20 x 20 cm, 8 x 8 in,  
white, smooth



Wall/floor tile  
20 x 20 cm, 8 x 8 in,  
beige, smooth



Wall/floor tile  
20 x 20 cm, 8 x 8 in,  
grey, smooth



Wall/floor tile  
20 x 20 cm, 8 x 8 in,  
anthracite, smooth



Wall/floor tile  
20 x 20 cm, 8 x 8 in,  
cement grey, structured, R10/B



Wall/floor tile Vanda 20 x 20 cm, 8 x 8 in, multicolored, smooth, R10/B



Individual motif Baleno 20 x 20 cm, 8 x 8 in,  
multicolored, smooth, R10/B

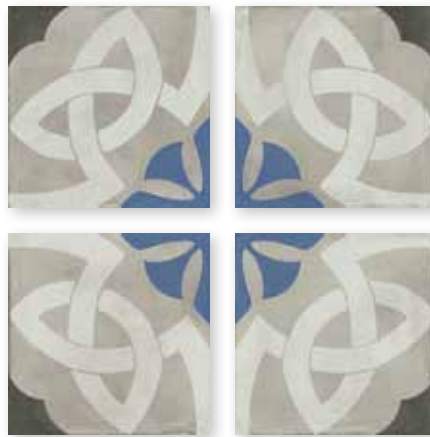

Individual motif Isola 20 x 20 cm, 8 x 8 in,  
multicolored, smooth, R10/B

The articles Vanda each depict different motifs.  
Arrangement and packing are random and arbitrary.

Mosaic

2,5 x 2,5 cm



Vola  
Sheet: 297 x 297 mm

5 x 5 cm



Vola  
Sheet: 297 x 297 mm

5 x 5 cmw



Ornamenta  
Sheet: 297 x 297 mm

10 x 10 cm



Vola  
Sheet: 297 x 297 mm

10 x 10 cm



Mesh  
Sheet: 297 x 297 mm

10 x 10 cm



Sheet: 297 x 297 mm



	2.5 x 2.5 / 1 x 1	5 x 5 / 2 x 2	5 x 5 cm / 2 x 2	10 x 10 / 4 x 4	10 x 10 / 4 x 4	10 x 10 / 4 x 4	
	23 x 23 x 6.5 mm	47 x 47 x 6.5 mm	47 x 47 x 6.5 mm	97 x 97 x 6.5 mm	97 x 97 x 6.5 mm	97 x 97 x 6.5 mm	Nom. dim. - cm/in
	smooth, silky-matt	smooth, silky-matt	smooth, matt	smooth, silky-matt	smooth, silky-matt	smooth, silky-matt	Work size
	11 sheets	11 sheets	11.000	11 sheets	11 sheets	11 sheets	Surface
	12.100	12.331	12.331	13.101	13.101	13.101	m <sup>2</sup> - pieces
	11 sheets	11 sheets	11 sheets	11 sheets	11 sheets	11 sheets	m <sup>2</sup> - kg
	1.000	1.000	1.000	1.000	1.000	1.000	Bundle - pieces
	12.100	12.331	12.331	13.101	13.101	13.101	Bundle - m <sup>2</sup>
	48.000	64.000	64.000	64.000	64.000	64.000	Bundle - kg
	580.800	789.184	789.184	838.464	838.464	838.464	Pallet - m <sup>2</sup>
	B1b	B1b	B1b	B1b	B1b	B1b	Pallet - kg
		R10/B					Product standard
	1	1	1	1	1	1	Slip resistance
	<b>42400H</b>	<b>42500H</b>		<b>42020H</b>			Stress group
	Price gr. <b>W303</b> (pce.)	Price gr. <b>W171</b> (m <sup>2</sup> )		Price gr. <b>W150</b> (m <sup>2</sup> )			4
	<b>42401H</b>						3
	Price gr. <b>W303</b> (pce.)						3
	<b>42402H</b>	<b>42501H</b>					4
	Price gr. <b>W303</b> (pce.)	Price gr. <b>W171</b> (m <sup>2</sup> )					3
			<b>42502H</b>				3
			Price gr. <b>W171</b> (m <sup>2</sup> )				3
			<b>42503H</b>				3
			Price gr. <b>W171</b> (m <sup>2</sup> )				3
					<b>42010H</b>		4
					Price gr. <b>W150</b> (m <sup>2</sup> )		4
						<b>42000H</b>	4
						Price gr. <b>W117</b> (m <sup>2</sup> )	4
						<b>42001H</b>	4
						Price gr. <b>W117</b> (m <sup>2</sup> )	4
						<b>42002H</b>	4
						Price gr. <b>W117</b> (m <sup>2</sup> )	4
							4

The articles Vola, Mesh and Ornamenta each depict different motifs.  
Arrangement and packing are random and arbitrary.

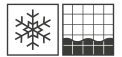

Wall and Floor Tiles

15 x 15 cm      20 x 20 cm      20 x 20 cm      20 x 20 cm      20 x 20 cm      20 x 20 cm      20 x 20 cm



	<i>Ornamenta</i>	<i>Vola</i>	<i>Salina</i>	<i>Individual motif Nelas</i>	<i>Individual motif Mellby</i>
Nom. dim. - cm/in	15 x 15 / 6 x 6	20 x 20 / 8 x 8	20 x 20 / 8 x 8	20 x 20 / 8 x 8	20 x 20 / 8 x 8
Work size	147 x 147 x 6.5 mm	197 x 197 x 6.5 mm	197 x 197 x 6.5 mm	197 x 197 x 6.5 mm	197 x 197 x 6.5 mm
Surface	smooth, matt	smooth, silky-matt	structured, matt	smooth, silky-matt	smooth, silky-matt
m <sup>2</sup> - pieces	44.444	25	25	25	25
m <sup>2</sup> - kg	13.955	13.875	13.875	13.875	13.875
Bundle - pieces	44	25	25	25	25
Bundle - m <sup>2</sup>	0.990	1.000	1.000	1.000	1.000
Bundle - kg	13.816	13.875	13.875	13.875	13.875
Pallet - m <sup>2</sup>	79.201	72.000	72.000	72.000	72.000
Pallet - kg	1,105.280	999.000	999.000	999.000	999.000
Product standard	Bib	Bib	Bla	Bib	Bib
Slip resistance			R10/B		
Stress group	1	1	1	1	1
white <input type="checkbox"/> V1	4	<b>42100H</b> Price gr. <b>W117</b> (m <sup>2</sup> )			
beige <input type="checkbox"/> V1	4	<b>42101H</b> Price gr. <b>W117</b> (m <sup>2</sup> )			
grey <input type="checkbox"/> V1	4	<b>42102H</b> Price gr. <b>W117</b> (m <sup>2</sup> )			
anthracite <input type="checkbox"/> V1	3	<b>42103H</b> Price gr. <b>W117</b> (m <sup>2</sup> )			
cement grey <input type="checkbox"/> V4			<b>44425H</b> Price gr. <b>W117</b> (m <sup>2</sup> )		
multicolored <input type="checkbox"/> V4	4		<b>42120H</b> Price gr. <b>W150</b> (m <sup>2</sup> )	<b>42130H</b> Price gr. <b>W150</b> (m <sup>2</sup> )	
black-white <input type="checkbox"/> V4	4			<b>44400H</b> Price gr. <b>W150</b> (m <sup>2</sup> )	
grey <input type="checkbox"/> V4	4		<b>42121H</b> Price gr. <b>W150</b> (m <sup>2</sup> )		<b>44401H</b> Price gr. <b>W150</b> (m <sup>2</sup> )
blue <input type="checkbox"/> V3	3	<b>44500H</b> Price gr. <b>W111</b> (m <sup>2</sup> )			
multicolor <input type="checkbox"/> V4	3	<b>44501H</b> Price gr. <b>W111</b> (m <sup>2</sup> )			



The articles Vola, Mesh and Ornamenta each depict different motifs. Arrangement and packing are random and arbitrary.

Wall and Floor Tiles

20 x 20 cm      20 x 20 cm      20 x 20 cm



	<i>Individual motif Baleno</i>	<i>Individual motif Isola</i>	<i>Vanda</i>		
Nom. dim. - cm/in	20 x 20 / 8 x 8	20 x 20 / 8 x 8	20 x 20 / 8 x 8		
Work size	197 x 197 x 6.5 mm	197 x 197 x 6.5 mm	197 x 197 x 6.5 mm		
Surface	structured, matt	structured, matt	structured, matt		
m <sup>2</sup> - pieces	25	25	25		
m <sup>2</sup> - kg	13.875	13.875	13.875		
Bundle - pieces	25	25	25		
Bundle - m <sup>2</sup>	1.000	1.000	1.000		
Bundle - kg	13.875	13.875	13.875		
Pallet - m <sup>2</sup>	72.000	72.000	72.000		
Pallet - kg	999.000	999.000	999.000		
Product standard	Bla	Bla	Bla		
Slip resistance	R10/B	R10/B	R10/B		
Stress group	1	1	1		
multicolored <input type="checkbox"/> V4	<b>44447H</b> Price gr. <b>W150</b> (m <sup>2</sup> )	<b>44448H</b> Price gr. <b>W150</b> (m <sup>2</sup> )	<b>44449H</b> Price gr. <b>W150</b> (m <sup>2</sup> )		



The article Vanda each depict different motifs. Arrangement and packing are random and arbitrary.

Rendering







## A quotation from nature

For lovers of a natural look: the strikingly structured surface of the Pizarro series is reminiscent of slate – in a ceramic interpretation. The wall tiles in plain white and delicate grey are a perfect wall cladding for timeless bathrooms in a reduced ambience. For a rhythmic or accentuated look of the wall surface, elegant borders with metallic inlays are available.

Rendering

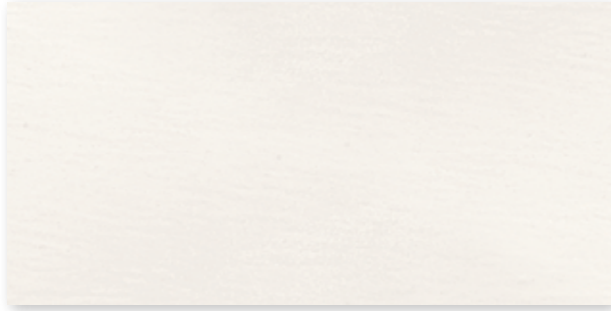

Wall tile 30 x 60 cm, 12 x 24 in, white, structured



Wall tile 30 x 60 cm, 12 x 24 in, grey, structured

## Decoration elements

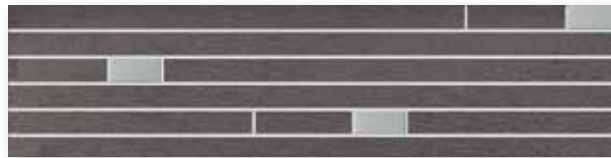

Border 15 x 60 cm, 6 x 24 in, anthracite, structured



Border 15 x 60 cm, 6 x 24 in, black, structured

Border: Glass fibre net on reverse side,  
Sheet: 147 x 597 mm



Wall Tile<sup>3</sup>

Decoration Element<sup>1/2/4/5</sup>

30 x 60 cm



15 x 60 cm



Border  
Sheet: 147 x 597 mm

					<b>30 x 60 / 12 x 24</b>	<b>15 x 60 / 6 x 24</b>	Nom. dim. - cm/in
					297 x 597 x 9 mm	147 x 597 x 10.5 mm	Work size
					structured, silky-matt	structured, matt	Surface
					5.556/m <sup>2</sup>	1.667/m	m <sup>2</sup> /m - pieces
					14.946/m <sup>2</sup>	3.584/m	m <sup>2</sup> /m - kg
					9	1	Bundle - pieces
					1.620 m <sup>2</sup>	0.600 m	Bundle - m <sup>2</sup> /m
					24.210	2.150	Bundle - kg
					77.754		Pallet - m <sup>2</sup>
					1,162.080		Pallet - kg
					BIII	Bla	Product standard
					<b>281476</b>		white <input type="checkbox"/> V1
					Price gr. C89 (m <sup>2</sup> )		grey <input type="checkbox"/> V1
					<b>281477</b>		anthracite <input type="checkbox"/> V2
					Price gr. C89 (m <sup>2</sup> )		black <input type="checkbox"/> V1
						<b>281479</b>	
						Price gr. C502 (pce.)	
						<b>281480</b>	
						Price gr. C502 (pce.)	



<sup>3</sup> not frost-proof  
<sup>4</sup> Decoration elements only available in full boxes.  
<sup>5</sup> Only suitable for laying on the wall.



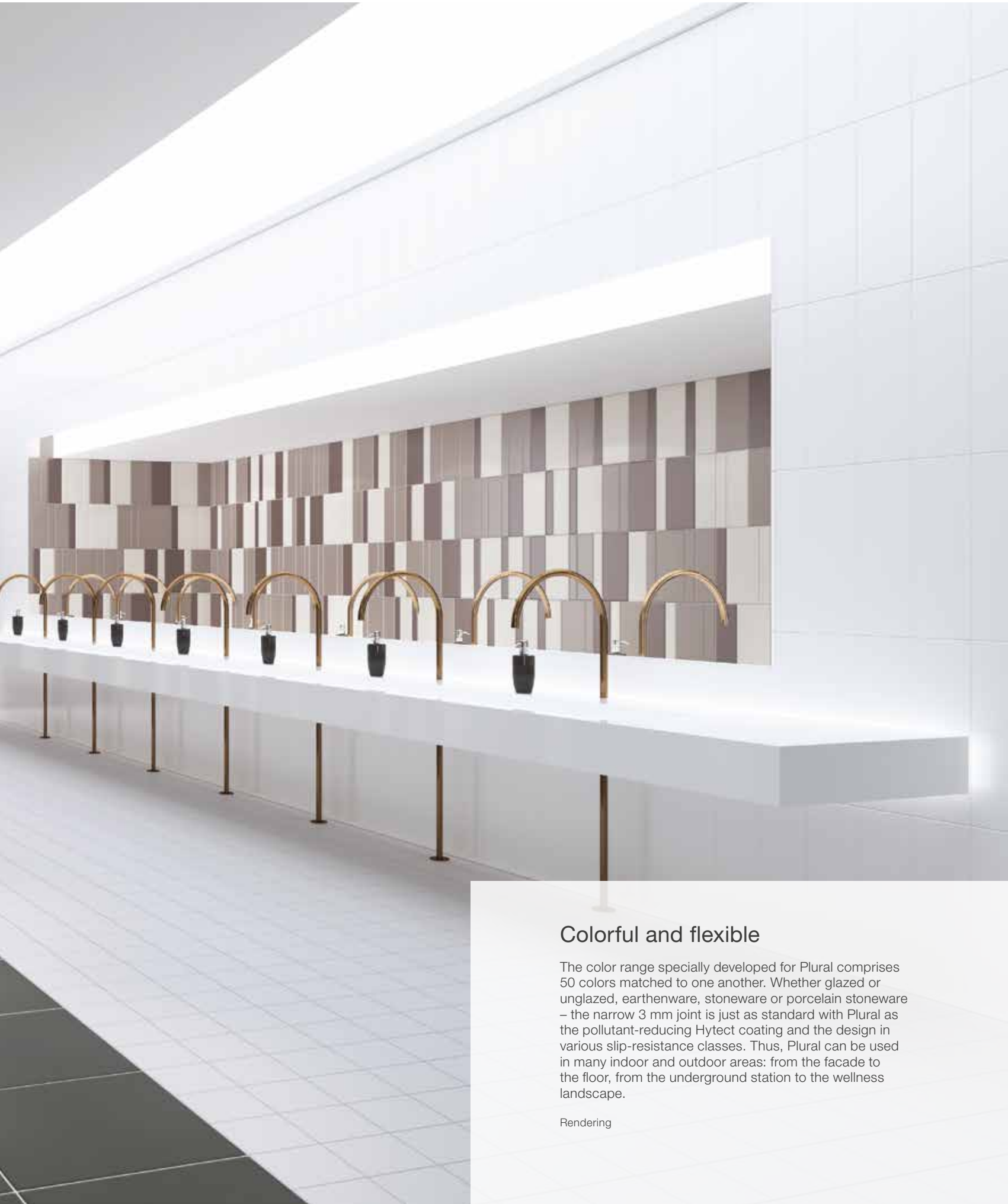

## Colorful and flexible

The color range specially developed for Plural comprises 50 colors matched to one another. Whether glazed or unglazed, earthenware, stoneware or porcelain stoneware – the narrow 3 mm joint is just as standard with Plural as the pollutant-reducing Hytect coating and the design in various slip-resistance classes. Thus, Plural can be used in many indoor and outdoor areas: from the facade to the floor, from the underground station to the wellness landscape.

Rendering

Color System UNICOLOR – A color sphere becomes a sphere of possibilities



active ochre NCS S 3050-Y40R	active salmon NCS S 4040-Y70R	active oxid red NCS S 4050-Y90R	active stone grey NCS S 5030-Y90R	active sand grey NCS S 7010-Y90R
light ochre NCS S 2030-Y20R	light salmon NCS S 1515-Y50R	light oxid red NCS S 2010-Y80R	light stone grey NCS S 2502-R	light sand grey NCS S 1502-Y
medium ochre NCS S 3030-Y30R	medium salmon NCS S 2020-Y50R	medium oxid red NCS S 3020-Y80R	medium stone grey NCS S 3502-R or RAL 7036	medium sand grey NCS S 3005-Y50R
dark ochre NCS S 4030-Y50R	dark salmon NCS S 3040-Y60R	dark oxid red NCS S 5020-Y80R	dark stone grey NCS S 6005-Y80R	dark sand grey NCS S 6010-Y50R
<b>ochre</b>		<b>salmon</b>		<b>oxid red</b>
			<b>stone grey</b>	<b>sand-grey</b>
neutral 5 (basalt-grey) NCS S 5502-B or RAL 7046	neutral 4 (graphite-black) NCS S 6000-N or RAL 7037	neutral 3 (asphalt black) NCS S 6500-N	neutral 2 (anthracite) NCS S 7500-N or RAL 7015	neutral 1 (deep black) NCS S 9000-N or RAL 9017



sea green  
NCS S4030-G  
or RAL design  
6000



blue green  
NCS S3040-B50G  
or RAL design  
190 50 25



cobalt blue  
NCS S4055-R70B  
or RAL design  
290 30 40

Intense colors

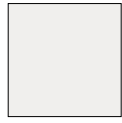

1120/1121  
neutral 10 (active white)

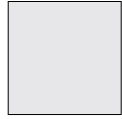

1119  
neutral 9 (white-grey)



1118  
neutral 8 (light-grey)



1117  
neutral 7 (pebble-grey)



1115  
neutral 5 (basalt-grey)



1113  
neutral 3 (asphalt black)



1112  
neutral 2 (anthracite)



1111  
neutral 1 (deep black)



1004  
dark azure



1003  
medium azure



1002  
light azure



1008  
dark blue

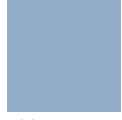

1007  
medium blue

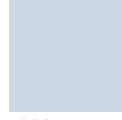

1006  
light blue



1012  
dark turquoise



1011  
medium turquoise



1010  
light turquoise



1016  
dark green



1015  
medium green

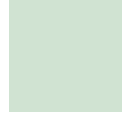

1014  
light green



1020  
dark yellow



1019  
medium yellow



1018  
light yellow



1024  
dark ochre



1023  
medium ochre



1022  
light ochre



1028  
dark salmon



1027  
medium salmon



1026  
light salmon



1032  
dark oxid red



1031  
medium oxid red

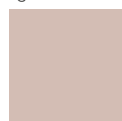

1030  
light oxid red



1036  
dark stone grey



1035  
medium stone grey

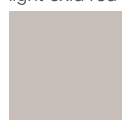

1034  
light stone grey

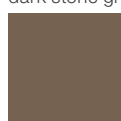

1040  
dark sand grey



1039  
medium sand grey

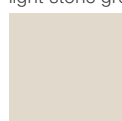

1038  
light sand grey



1001  
active azure



1005  
active blue



1009  
active turquoise



1013  
active green



1017  
active yellow



1021  
active ochre



1025  
active salmon



1029  
active oxid red



1033  
active stone grey

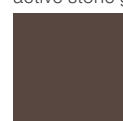

1037  
active sand grey



1050  
cobalt blue



1049  
blue green



1048  
sea green



1047  
yellow green



1046  
sunshine yellow



1045  
signal orange



1044  
fire red



1043  
brown red



1042  
berry red

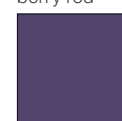

1041  
violet

## Formats – Earthenware



Wall tile 15 x 30 cm  
6 x 12 in, smooth

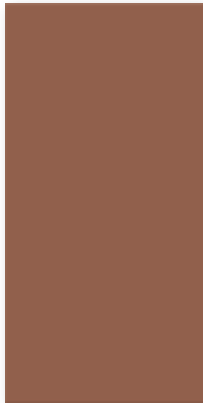

Wall tile 20 x 40 cm  
8 x 16 in, smooth

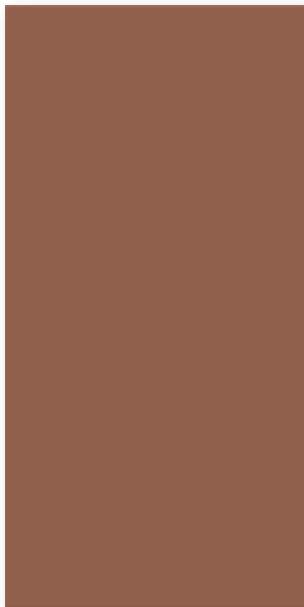

Wall tile 30 x 60 cm,  
12 x 24 in, smooth

### Wall Tiles<sup>3</sup>

15 x 30 cm<sup>2</sup>



20 x 40 cm<sup>2</sup>

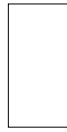

30 x 60 cm



Nom. dim. - cm/in	15 x 30 / 6 x 12	20 x 40 / 8 x 16	30 x 60 / 12 x 24				
Work size	147 x 297 x 6.5 mm	197 x 397 x 7.5 mm	297 x 597 x 9 mm				
Surface	smooth, silky-matt	smooth, silky-matt	smooth, silky-matt				
m <sup>2</sup> - pieces	22.222	12.500	5.556				
m <sup>2</sup> - kg	10.622	12.975	14.946				
Bundle - pieces	24	16	9				
Bundle - m <sup>2</sup>	1.080	1.280	1.620				
Bundle - kg	11.472	16.608	24.210				
Pallet - m <sup>2</sup>	91.801	92.160	77.754				
Pallet - kg	975.120	1,195.776	1,162.080				
Product standard	BIII	BIII	BIII				
neutral 10	<b>130-1121H</b>	<b>240-1121H</b>	<b>360-1121H</b>				
(active white gl.) <input type="checkbox"/>	Price gr. <b>A100</b> (m <sup>2</sup> )	Price gr. <b>A100</b> (m <sup>2</sup> )	Price gr. <b>A88</b> (m <sup>2</sup> )				
neutral 10	<b>130-1120H</b>	<b>240-1120H</b>	<b>360-1120H</b>				
(active white) <input type="checkbox"/>	Price gr. <b>A100</b> (m <sup>2</sup> )	Price gr. <b>A100</b> (m <sup>2</sup> )	Price gr. <b>A88</b> (m <sup>2</sup> )				
neutral 9	<b>130-1119H</b>	<b>240-1119H</b>	<b>360-1119H</b>				
(white grey) <input type="checkbox"/>	Price gr. <b>A121</b> (m <sup>2</sup> )	Price gr. <b>A121</b> (m <sup>2</sup> )	Price gr. <b>A109</b> (m <sup>2</sup> )				
neutral 8	<b>130-1118H<sup>1</sup></b>	<b>240-1118H<sup>1</sup></b>	<b>360-1118H</b>				
(light-grey) <input type="checkbox"/>	Price gr. <b>A148</b> (m <sup>2</sup> )	Price gr. <b>A148</b> (m <sup>2</sup> )	Price gr. <b>A109</b> (m <sup>2</sup> )				
neutral 7	<b>130-1117H</b>	<b>240-1117H</b>	<b>360-1117H</b>				
(pebble-grey) <input type="checkbox"/>	Price gr. <b>A121</b> (m <sup>2</sup> )	Price gr. <b>A121</b> (m <sup>2</sup> )	Price gr. <b>A109</b> (m <sup>2</sup> )				
neutral 5	<b>130-1115H</b>	<b>240-1115H</b>	<b>360-1115H</b>				
(basalt grey) <input type="checkbox"/>	Price gr. <b>A121</b> (m <sup>2</sup> )	Price gr. <b>A121</b> (m <sup>2</sup> )	Price gr. <b>A109</b> (m <sup>2</sup> )				
neutral 3	<b>130-1113H</b>	<b>240-1113H</b>	<b>360-1113H</b>				
(asphalt black) <input type="checkbox"/>	Price gr. <b>A121</b> (m <sup>2</sup> )	Price gr. <b>A121</b> (m <sup>2</sup> )	Price gr. <b>A109</b> (m <sup>2</sup> )				
neutral 2	<b>130-1112H<sup>1</sup></b>	<b>240-1112H<sup>1</sup></b>	<b>360-1112H<sup>1</sup></b>				
(anthracite) <input type="checkbox"/>	Price gr. <b>A121</b> (m <sup>2</sup> )	Price gr. <b>A148</b> (m <sup>2</sup> )	Price gr. <b>A136</b> (m <sup>2</sup> )				
neutral 1	<b>130-1111H</b>	<b>240-1111H</b>	<b>360-1111H</b>				
(deep black) <input type="checkbox"/>	Price gr. <b>A121</b> (m <sup>2</sup> )	Price gr. <b>A121</b> (m <sup>2</sup> )	Price gr. <b>A109</b> (m <sup>2</sup> )				
active azure	<b>130-1001H<sup>1</sup></b>	<b>240-1001H<sup>1</sup></b>	<b>360-1001H<sup>1</sup></b>				
<input type="checkbox"/>	Price gr. <b>A148</b> (m <sup>2</sup> )	Price gr. <b>A148</b> (m <sup>2</sup> )	Price gr. <b>A136</b> (m <sup>2</sup> )				
light azure	<b>130-1002H<sup>1</sup></b>	<b>240-1002H</b>	<b>360-1002H<sup>1</sup></b>				
<input type="checkbox"/>	Price gr. <b>A148</b> (m <sup>2</sup> )	Price gr. <b>A121</b> (m <sup>2</sup> )	Price gr. <b>A136</b> (m <sup>2</sup> )				
medium azure	<b>130-1003H<sup>1</sup></b>	<b>240-1003H<sup>1</sup></b>	<b>360-1003H<sup>1</sup></b>				
<input type="checkbox"/>	Price gr. <b>A148</b> (m <sup>2</sup> )	Price gr. <b>A148</b> (m <sup>2</sup> )	Price gr. <b>A136</b> (m <sup>2</sup> )				
dark azure	<b>130-1004H</b>	<b>240-1004H</b>	<b>360-1004H</b>				
<input type="checkbox"/>	Price gr. <b>A121</b> (m <sup>2</sup> )	Price gr. <b>A121</b> (m <sup>2</sup> )	Price gr. <b>A109</b> (m <sup>2</sup> )				
active blue	<b>130-1005H<sup>1</sup></b>	<b>240-1005H<sup>1</sup></b>	<b>360-1005H<sup>1</sup></b>				
<input type="checkbox"/>	Price gr. <b>A148</b> (m <sup>2</sup> )	Price gr. <b>A148</b> (m <sup>2</sup> )	Price gr. <b>A136</b> (m <sup>2</sup> )				
light blue	<b>130-1006H<sup>1</sup></b>	<b>240-1006H</b>	<b>360-1006H<sup>1</sup></b>				
<input type="checkbox"/>	Price gr. <b>A148</b> (m <sup>2</sup> )	Price gr. <b>A121</b> (m <sup>2</sup> )	Price gr. <b>A136</b> (m <sup>2</sup> )				
medium blue	<b>130-1007H<sup>1</sup></b>	<b>240-1007H<sup>1</sup></b>	<b>360-1007H<sup>1</sup></b>				
<input type="checkbox"/>	Price gr. <b>A148</b> (m <sup>2</sup> )	Price gr. <b>A148</b> (m <sup>2</sup> )	Price gr. <b>A136</b> (m <sup>2</sup> )				
dark blue	<b>130-1008H</b>	<b>240-1008H</b>	<b>360-1008H</b>				
<input type="checkbox"/>	Price gr. <b>A121</b> (m <sup>2</sup> )	Price gr. <b>A121</b> (m <sup>2</sup> )	Price gr. <b>A109</b> (m <sup>2</sup> )				
active turquoise	<b>130-1009H<sup>1</sup></b>	<b>240-1009H<sup>1</sup></b>	<b>360-1009H<sup>1</sup></b>				
<input type="checkbox"/>	Price gr. <b>A148</b> (m <sup>2</sup> )	Price gr. <b>A148</b> (m <sup>2</sup> )	Price gr. <b>A136</b> (m <sup>2</sup> )				
light turquoise	<b>130-1010H<sup>1</sup></b>	<b>240-1010H</b>	<b>360-1010H<sup>1</sup></b>				
<input type="checkbox"/>	Price gr. <b>A148</b> (m <sup>2</sup> )	Price gr. <b>A121</b> (m <sup>2</sup> )	Price gr. <b>A136</b> (m <sup>2</sup> )				
medium turquoise	<b>130-1011H<sup>1</sup></b>	<b>240-1011H<sup>1</sup></b>	<b>360-1011H<sup>1</sup></b>				
<input type="checkbox"/>	Price gr. <b>A148</b> (m <sup>2</sup> )	Price gr. <b>A148</b> (m <sup>2</sup> )	Price gr. <b>A136</b> (m <sup>2</sup> )				
dark turquoise	<b>130-1012H</b>	<b>240-1012H</b>	<b>360-1012H</b>				
<input type="checkbox"/>	Price gr. <b>A121</b> (m <sup>2</sup> )	Price gr. <b>A121</b> (m <sup>2</sup> )	Price gr. <b>A109</b> (m <sup>2</sup> )				
active green	<b>130-1013H<sup>1</sup></b>	<b>240-1013H<sup>1</sup></b>	<b>360-1013H<sup>1</sup></b>				
<input type="checkbox"/>	Price gr. <b>A148</b> (m <sup>2</sup> )	Price gr. <b>A148</b> (m <sup>2</sup> )	Price gr. <b>A136</b> (m <sup>2</sup> )				
light green	<b>130-1014H<sup>1</sup></b>	<b>240-1014H</b>	<b>360-1014H<sup>1</sup></b>				
<input type="checkbox"/>	Price gr. <b>A148</b> (m <sup>2</sup> )	Price gr. <b>A121</b> (m <sup>2</sup> )	Price gr. <b>A136</b> (m <sup>2</sup> )				
medium green	<b>130-1015H<sup>1</sup></b>	<b>240-1015H<sup>1</sup></b>	<b>360-1015H<sup>1</sup></b>				
<input type="checkbox"/>	Price gr. <b>A148</b> (m <sup>2</sup> )	Price gr. <b>A148</b> (m <sup>2</sup> )	Price gr. <b>A136</b> (m <sup>2</sup> )				
dark green	<b>130-1016H</b>	<b>240-1016H</b>	<b>360-1016H</b>				
<input type="checkbox"/>	Price gr. <b>A121</b> (m <sup>2</sup> )	Price gr. <b>A121</b> (m <sup>2</sup> )	Price gr. <b>A109</b> (m <sup>2</sup> )				



<sup>2</sup> One overglazed head edge 10% per delivery. Edges overglazed 2/3 each.

<sup>3</sup> Suitability for operating theatres on request.



Wall Tiles<sup>3</sup>

15 x 30 cm<sup>2</sup>



20 x 40 cm<sup>2</sup>



30 x 60 cm



	15 x 30 / 6 x 12	20 x 40 / 8 x 16	30 x 60 / 12 x 24	Nom. dim. - cm/in
	147 x 297 x 6.5 mm	197 x 397 x 7.5 mm	297 x 597 x 9 mm	Work size
	smooth, silky-matt	smooth, silky-matt	smooth, silky-matt	Surface
	22.222	12.500	5.556	m <sup>2</sup> - pieces
	10.622	12.975	14.946	m <sup>2</sup> - kg
	24	16	9	Bundle - pieces
	1.080	1.280	1.620	Bundle - m <sup>2</sup>
	11.472	16.608	24.210	Bundle - kg
	91.801	92.160	77.754	Pallet - m <sup>2</sup>
	975.120	1,195.776	1,162.080	Pallet - kg
	BIII	BIII	BIII	Product standard
	130-1017H <sup>1</sup>	240-1017H <sup>1</sup>	360-1017H <sup>1</sup>	active yellow <input type="checkbox"/>
	Price gr. A148 (m <sup>2</sup> )	Price gr. A148 (m <sup>2</sup> )	Price gr. A136 (m <sup>2</sup> )	
	130-1018H <sup>1</sup>	240-1018H	360-1018H <sup>1</sup>	light yellow <input type="checkbox"/>
	Price gr. A148 (m <sup>2</sup> )	Price gr. A121 (m <sup>2</sup> )	Price gr. A136 (m <sup>2</sup> )	
	130-1019H <sup>1</sup>	240-1019H <sup>1</sup>	360-1019H <sup>1</sup>	medium yellow <input type="checkbox"/>
	Price gr. A148 (m <sup>2</sup> )	Price gr. A148 (m <sup>2</sup> )	Price gr. A136 (m <sup>2</sup> )	
	130-1020H	240-1020H	360-1020H	dark yellow <input type="checkbox"/>
	Price gr. A121 (m <sup>2</sup> )	Price gr. A121 (m <sup>2</sup> )	Price gr. A109 (m <sup>2</sup> )	
	130-1021H <sup>1</sup>	240-1021H <sup>1</sup>	360-1021H <sup>1</sup>	active ochre <input type="checkbox"/>
	Price gr. A148 (m <sup>2</sup> )	Price gr. A148 (m <sup>2</sup> )	Price gr. A136 (m <sup>2</sup> )	
	130-1022H <sup>1</sup>	240-1022H	360-1022H <sup>1</sup>	light ochre <input type="checkbox"/>
	Price gr. A148 (m <sup>2</sup> )	Price gr. A121 (m <sup>2</sup> )	Price gr. A136 (m <sup>2</sup> )	
	130-1023H <sup>1</sup>	240-1023H <sup>1</sup>	360-1023H <sup>1</sup>	medium ochre <input type="checkbox"/>
	Price gr. A148 (m <sup>2</sup> )	Price gr. A148 (m <sup>2</sup> )	Price gr. A136 (m <sup>2</sup> )	
	130-1024H	240-1024H	360-1024H	dark ochre <input type="checkbox"/>
	Price gr. A121 (m <sup>2</sup> )	Price gr. A121 (m <sup>2</sup> )	Price gr. A109 (m <sup>2</sup> )	
	130-1025H <sup>1</sup>	240-1025H <sup>1</sup>	360-1025H <sup>1</sup>	active salmon <input type="checkbox"/>
	Price gr. A148 (m <sup>2</sup> )	Price gr. A148 (m <sup>2</sup> )	Price gr. A136 (m <sup>2</sup> )	
	130-1026H <sup>1</sup>	240-1026H	360-1026H <sup>1</sup>	light salmon <input type="checkbox"/>
	Price gr. A148 (m <sup>2</sup> )	Price gr. A121 (m <sup>2</sup> )	Price gr. A136 (m <sup>2</sup> )	
	130-1027H <sup>1</sup>	240-1027H <sup>1</sup>	360-1027H <sup>1</sup>	medium salmon <input type="checkbox"/>
	Price gr. A148 (m <sup>2</sup> )	Price gr. A148 (m <sup>2</sup> )	Price gr. A136 (m <sup>2</sup> )	
	130-1028H	240-1028H	360-1028H	dark salmon <input type="checkbox"/>
	Price gr. A121 (m <sup>2</sup> )	Price gr. A121 (m <sup>2</sup> )	Price gr. A109 (m <sup>2</sup> )	
	130-1029H <sup>1</sup>	240-1029H <sup>1</sup>	360-1029H <sup>1</sup>	active oxide red <input type="checkbox"/>
	Price gr. A148 (m <sup>2</sup> )	Price gr. A148 (m <sup>2</sup> )	Price gr. A136 (m <sup>2</sup> )	
	130-1030H <sup>1</sup>	240-1030H	360-1030H <sup>1</sup>	light oxide red <input type="checkbox"/>
	Price gr. A148 (m <sup>2</sup> )	Price gr. A121 (m <sup>2</sup> )	Price gr. A136 (m <sup>2</sup> )	
	130-1031H <sup>1</sup>	240-1031H <sup>1</sup>	360-1031H <sup>1</sup>	medium oxide red <input type="checkbox"/>
	Price gr. A148 (m <sup>2</sup> )	Price gr. A148 (m <sup>2</sup> )	Price gr. A136 (m <sup>2</sup> )	
	130-1032H	240-1032H	360-1032H	dark oxide red <input type="checkbox"/>
	Price gr. A121 (m <sup>2</sup> )	Price gr. A121 (m <sup>2</sup> )	Price gr. A109 (m <sup>2</sup> )	
	130-1033H <sup>1</sup>	240-1033H <sup>1</sup>	360-1033H <sup>1</sup>	active stone grey <input type="checkbox"/>
	Price gr. A148 (m <sup>2</sup> )	Price gr. A148 (m <sup>2</sup> )	Price gr. A136 (m <sup>2</sup> )	
	130-1034H <sup>1</sup>	240-1034H	360-1034H <sup>1</sup>	light stone grey <input type="checkbox"/>
	Price gr. A148 (m <sup>2</sup> )	Price gr. A121 (m <sup>2</sup> )	Price gr. A136 (m <sup>2</sup> )	
	130-1035H <sup>1</sup>	240-1035H <sup>1</sup>	360-1035H <sup>1</sup>	medium stone grey <input type="checkbox"/>
	Price gr. A148 (m <sup>2</sup> )	Price gr. A148 (m <sup>2</sup> )	Price gr. A136 (m <sup>2</sup> )	
	130-1036H	240-1036H	360-1036H	dark stone grey <input type="checkbox"/>
	Price gr. A121 (m <sup>2</sup> )	Price gr. A121 (m <sup>2</sup> )	Price gr. A109 (m <sup>2</sup> )	
	130-1037H <sup>1</sup>	240-1037H <sup>1</sup>	360-1037H <sup>1</sup>	active sand-grey <input type="checkbox"/>
	Price gr. A148 (m <sup>2</sup> )	Price gr. A148 (m <sup>2</sup> )	Price gr. A136 (m <sup>2</sup> )	
	130-1038H	240-1038H	360-1038H	light sand-grey <input type="checkbox"/>
	Price gr. A121 (m <sup>2</sup> )	Price gr. A121 (m <sup>2</sup> )	Price gr. A109 (m <sup>2</sup> )	
	130-1039H	240-1039H <sup>1</sup>	360-1039H <sup>1</sup>	medium sand-grey <input type="checkbox"/>
	Price gr. A121 (m <sup>2</sup> )	Price gr. A148 (m <sup>2</sup> )	Price gr. A136 (m <sup>2</sup> )	
	130-1040H	240-1040H	360-1040H	dark sand-grey <input type="checkbox"/>
	Price gr. A121 (m <sup>2</sup> )	Price gr. A121 (m <sup>2</sup> )	Price gr. A109 (m <sup>2</sup> )	



<sup>2</sup> One overglazed head edge 10% per delivery. Edges overglazed 2/3 each.

<sup>3</sup> Suitability for operating theatres on request.

# 346 Plural earthenware

Dry-pressed Ceramic Tiles, DIN EN 14411, group BIII, glazed (GL) for wall coverings in indoor areas (earthenware tiles)

## Wall Tiles<sup>1</sup> **NEW**

15 x 30 cm



30 x 60 cm

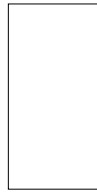

Nom. dim. - cm/in	15 x 30 / 6 x 12	30 x 60 / 12 x 24				
Work size	147 x 297 x 6.5 mm	297 x 597 x 9 mm				
Surface	smooth, silky-matt	smooth, silky-matt				
m <sup>2</sup> - pieces	22.222	5.556				
m <sup>2</sup> - kg	10.622	14.946				
Bundle - pieces	24	9				
Bundle - m <sup>2</sup>	1.080	1.620				
Bundle - kg	11.472	24.210				
Pallet - m <sup>2</sup>	91.801	77.754				
Pallet - kg	975.120	1,162.080				
Product standard	BIII	BIII				
violet <input type="checkbox"/>	<i>130-1041H</i> Price gr. A148 (m <sup>2</sup> )	<i>360-1041H</i> Price gr. A148 (m <sup>2</sup> )				
berry red <input type="checkbox"/>	<i>130-1042H</i> Price gr. A148 (m <sup>2</sup> )	<i>360-1042H</i> Price gr. A148 (m <sup>2</sup> )				
brown red <input type="checkbox"/>	<i>130-1043H</i> Price gr. A148 (m <sup>2</sup> )	<i>360-1043H</i> Price gr. A148 (m <sup>2</sup> )				
fire red <input type="checkbox"/>	<i>130-1044H</i> Price gr. A148 (m <sup>2</sup> )	<i>360-1044H</i> Price gr. A148 (m <sup>2</sup> )				
signal orange <input type="checkbox"/>	<i>130-1045H</i> Price gr. A148 (m <sup>2</sup> )	<i>360-1045H</i> Price gr. A148 (m <sup>2</sup> )				
sunshine yellow <input type="checkbox"/>	<i>130-1046H</i> Price gr. A148 (m <sup>2</sup> )	<i>360-1046H</i> Price gr. A148 (m <sup>2</sup> )				
yellow green <input type="checkbox"/>	<i>130-1047H</i> Price gr. A148 (m <sup>2</sup> )	<i>360-1047H</i> Price gr. A148 (m <sup>2</sup> )				
sea green <input type="checkbox"/>	<i>130-1048H</i> Price gr. A148 (m <sup>2</sup> )	<i>360-1048H</i> Price gr. A148 (m <sup>2</sup> )				
blue green <input type="checkbox"/>	<i>130-1049H</i> Price gr. A148 (m <sup>2</sup> )	<i>360-1049H</i> Price gr. A148 (m <sup>2</sup> )				
cobalt blue <input type="checkbox"/>	<i>130-1050H</i> Price gr. A148 (m <sup>2</sup> )	<i>360-1050H</i> Price gr. A148 (m <sup>2</sup> )				





Intense colors

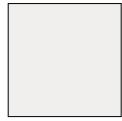

2120/2121/700/701  
neutral 10 (active white)



2119/552119  
neutral 9 (white-grey)



2118/552118  
neutral 8 (light-grey)



2117/552117  
neutral 7 (pebble-grey)



2116/552116  
neutral 6 (pearl grey)



2115/552115  
neutral 5 (basalt-grey)



2114/552114  
neutral 4 (graphite-black)



2113/552113  
neutral 3 (asphalt black)



2112/552112  
neutral 2 (anthracite)



2111/5716  
neutral 1 (deep black)



2004/552004  
dark azure



2003/552003  
medium azure



2002/552002  
light azure



2008/552008  
dark blue



2007/552007  
medium blue

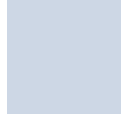

2006/552006  
light blue



2012/552012  
dark turquoise



2011/552011  
medium turquoise

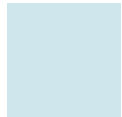

2010/552010  
light turquoise



2016/552016  
dark green



2015/552015  
medium green



2014/552014  
light green



2020/552020  
dark yellow



2019/552019  
medium yellow



2018/552018  
light yellow



2024/552024  
dark ochre



2023/552023  
medium ochre



2022/552022  
light ochre



2028/552028  
dark salmon



2027/552027  
medium salmon



2026/552026  
light salmon



2032/552032  
dark oxid red



2031/552031  
medium oxid red



2030/552030  
light oxid red



2036/552036  
dark stone grey



2035/552035  
medium stone grey



2034/552034  
light stone grey



2040/552040  
dark sand grey



2039/552039  
medium sand grey

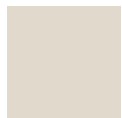

2038/552038  
light sand grey



2001/552001  
active azure



2005/552005  
active blue



2009/552009  
active turquoise



2013/552013  
active green



2017/552017  
active yellow



2021/552021  
active ochre



2025/552025  
active salmon



2029/552029  
active oxid red



2033/552033  
active stone grey



2037/552037  
active sand grey



2050  
cobalt-blue



2049  
blue-green



2048  
sea-green



2047  
yellow-green



2046  
sunshine-yellow



2045  
signal-orange



2044  
fire-red



2043  
brown-red



2042  
berry-red



2041  
violet

## Formats Stoneware

### Mosaic 2.5 x 2.5 cm, 1 x 1 in

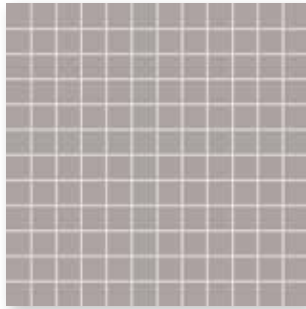

Mosaic sheet 30 x 30 cm, 12 x 12 in,  
smooth



Floor/wall tile  
10 x 20 cm, 4 x 8 in,  
smooth

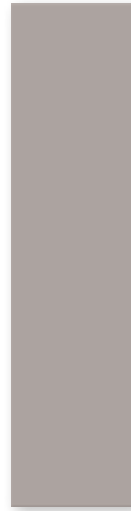

Floor/wall tile  
12.5 x 50 cm, 5 x 20 in,  
smooth

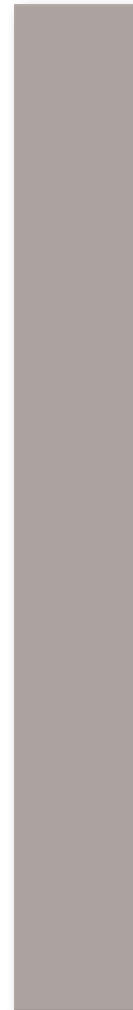

Floor/wall tile  
12.5 x 100 cm, 5 x 40 in,  
smooth

### Mosaic 5 x 5 cm, 2 x 2 in

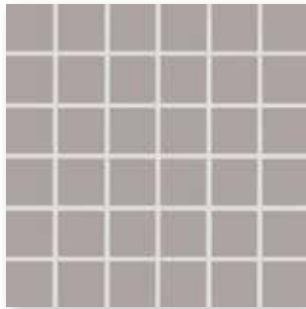

Mosaic sheet 30 x 30 cm, 12 x 12 in,  
smooth



Floor/wall tile  
10 x 30 cm, 4 x 12 in,  
smooth

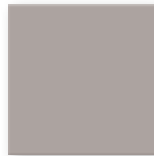

Floor/wall tile  
15 x 15 cm, 6 x 6 in,  
smooth

### Mosaic 10 x 10 cm, 4 x 4 in

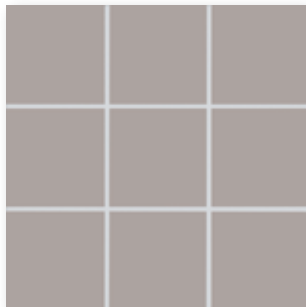

Mosaic sheet 30 x 30 cm, 12 x 12 in,  
smooth

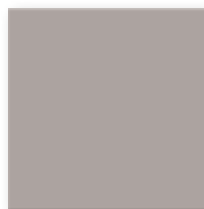

Floor/wall tile  
20 x 20 cm, 8 x 8 in,  
smooth



Mosaics glued thermoplastically on back of Agrob Buchtal can be used not only in dry zones but also without any problems in underwater areas (e.g. swimming pools/whirlpools) as well as in permanently wet areas.

Do you already know our Mosaic Designer at our website [www.agrob-buchtal.com](http://www.agrob-buchtal.com)? There, you will have the possibility of designing your individual color gradients, mosaic compositions and the laying of pictures.

350 Plural  
stoneware

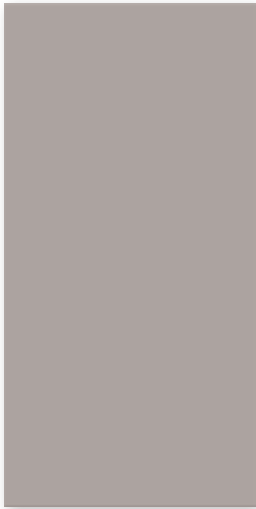

Floor/wall tile  
25 x 50 cm, 10 x 20 in,  
smooth



Floor/wall tile 30 x 30 cm, 12 x 12 in,  
smooth

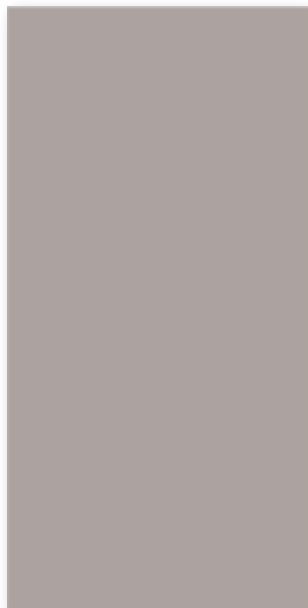

Floor/wall tile 30 x 60 cm, 12 x 24 in,  
smooth

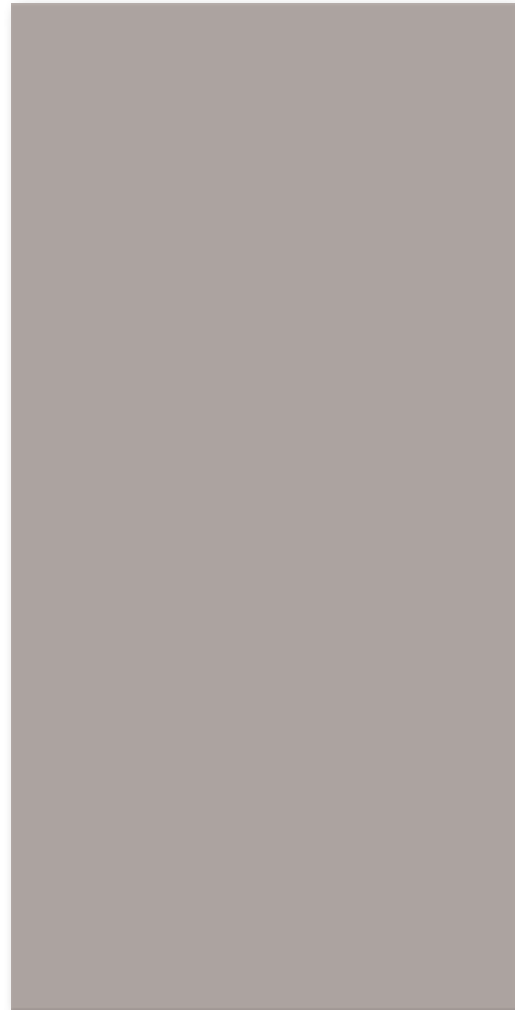

Floor/wall tile 50 x 100 cm, 20 x 40 in, smooth



Cove skirting  
10 x 10 cm  
4 x 4 in, smooth



Internal  
corner,  
smooth



External  
corner,  
smooth











Mosaic **NEW** Floor/ **NEW**  
Wall Tiles

10 x 10 cm<sup>1</sup>



20 x 20 cm<sup>1</sup>



Sheet: 297 x 297 mm

					<b>10 x 10 / 4 x 4</b>	<b>20 x 20 / 8 x 8</b>			Nom. dim. - cm/in
					97 x 97 x 6.5 mm	197 x 197 x 6.5 mm			Work size
					smooth, for op-theat.	smooth, for op-theat.			Surface
					11.000	25.000			m <sup>2</sup> - pieces
					13.101	13.875			m <sup>2</sup> - kg
					11	25			Bundle - pieces
					1.000	1.000			Bundle - m <sup>2</sup>
					13.101	13.875			Bundle - kg
					64.000	72.000			Pallet - m <sup>2</sup>
					838.464	999.000			Pallet - kg
					Blb	Blb			Product standard
					1	1			Stress group
					710-2041H	720-2041H			violet <input type="checkbox"/>
					Price gr. A196 (m <sup>2</sup> )	Price gr. A181 (m <sup>2</sup> )			
					710-2042H	720-2042H			berry red <input type="checkbox"/>
					Price gr. A196 (m <sup>2</sup> )	Price gr. A181 (m <sup>2</sup> )			
					710-2043H	720-2043H			brown red <input type="checkbox"/>
					Price gr. A196 (m <sup>2</sup> )	Price gr. A181 (m <sup>2</sup> )			
					710-2044H	720-2044H			fire red <input type="checkbox"/>
					Price gr. A196 (m <sup>2</sup> )	Price gr. A181 (m <sup>2</sup> )			
					710-2045H	720-2045H			signal orange <input type="checkbox"/>
					Price gr. A196 (m <sup>2</sup> )	Price gr. A181 (m <sup>2</sup> )			
					710-2046H	720-2046H			sunshine yellow <input type="checkbox"/>
					Price gr. A196 (m <sup>2</sup> )	Price gr. A181 (m <sup>2</sup> )			
					710-2047H	720-2047H			yellow green <input type="checkbox"/>
					Price gr. A196 (m <sup>2</sup> )	Price gr. A181 (m <sup>2</sup> )			
					710-2048H	720-2048H			sea green <input type="checkbox"/>
					Price gr. A196 (m <sup>2</sup> )	Price gr. A181 (m <sup>2</sup> )			
					710-2049H	720-2049H			blue green <input type="checkbox"/>
					Price gr. A196 (m <sup>2</sup> )	Price gr. A181 (m <sup>2</sup> )			
					710-2050H	720-2050H			cobalt blue <input type="checkbox"/>
					Price gr. A196 (m <sup>2</sup> )	Price gr. A181 (m <sup>2</sup> )			



Cove Skirting<sup>1</sup> Internal Corner for Cove Skirting<sup>1</sup> External Corner for Cove Skirting<sup>1</sup>

10 x 10 cm



Nom. dim. - cm/in	10 x 10 / 4 x 4	100 x 18 x 6.5 mm	100 x 18 x 6.5 mm			
Work size	100 x 97 x 6.5 mm	100 x 18 x 6.5 mm	100 x 18 x 6.5 mm			
Surface	smooth, silky-matt	smooth, silky-matt	smooth, silky-matt			
m - pieces	10.000					
m/pce. - kg	1.500/m	0.030/piece	0.030/piece			
Bundle - pieces	40	40	30			
Bundle - m	4.000					
Bundle - kg	6.000					
Pallet - m						
Pallet - kg						
Product standard	B1b	B1b	B1b			
Stress group	1	1	1			
neutral 10 (active white) <input type="checkbox"/>	4 <b>763-2120H</b> Price gr. <b>A416</b> (pce.)	<b>759-2120H</b> Price gr. <b>A430</b> (pce.)	<b>761-2120H</b> Price gr. <b>A430</b> (pce.)			
neutral 9 (white grey) <input type="checkbox"/>	4	<b>759-2119H</b> Price gr. <b>A430</b> (pce.)	<b>761-2119H</b> Price gr. <b>A430</b> (pce.)			
neutral 8 (light-grey) <input type="checkbox"/>	4 <b>763-2118H</b> Price gr. <b>A416</b> (pce.)	<b>759-2118H</b> Price gr. <b>A430</b> (pce.)	<b>761-2118H</b> Price gr. <b>A430</b> (pce.)			
neutral 7 (pebble-grey) <input type="checkbox"/>	4	<b>759-2117H</b> Price gr. <b>A430</b> (pce.)	<b>761-2117H</b> Price gr. <b>A430</b> (pce.)			
neutral 5 (basalt grey) <input type="checkbox"/>	3 <b>763-2115H</b> Price gr. <b>A416</b> (pce.)	<b>759-2115H</b> Price gr. <b>A430</b> (pce.)	<b>761-2115H</b> Price gr. <b>A430</b> (pce.)			
neutral 3 (asphalt black) <input type="checkbox"/>	3	<b>759-2113H</b> Price gr. <b>A430</b> (pce.)	<b>761-2113H</b> Price gr. <b>A430</b> (pce.)			
neutral 1 (deep black) <input type="checkbox"/>	1 <b>763-2111H</b> Price gr. <b>A416</b> (pce.)	<b>759-2111H</b> Price gr. <b>A430</b> (pce.)	<b>761-2111H</b> Price gr. <b>A430</b> (pce.)			
active azure <input type="checkbox"/>	2	<b>759-2001H</b> Price gr. <b>A430</b> (pce.)	<b>761-2001H</b> Price gr. <b>A430</b> (pce.)			
light azure <input type="checkbox"/>	4	<b>759-2002H</b> Price gr. <b>A430</b> (pce.)	<b>761-2002H</b> Price gr. <b>A430</b> (pce.)			
medium azure <input type="checkbox"/>	3 <b>763-2003H</b> Price gr. <b>A416</b> (pce.)	<b>759-2003H</b> Price gr. <b>A430</b> (pce.)	<b>761-2003H</b> Price gr. <b>A430</b> (pce.)			
dark azure <input type="checkbox"/>	2	<b>759-2004H</b> Price gr. <b>A430</b> (pce.)	<b>761-2004H</b> Price gr. <b>A430</b> (pce.)			
light blue <input type="checkbox"/>	4	<b>759-2006H</b> Price gr. <b>A430</b> (pce.)	<b>761-2006H</b> Price gr. <b>A430</b> (pce.)			
medium blue <input type="checkbox"/>	3	<b>759-2007H</b> Price gr. <b>A430</b> (pce.)	<b>761-2007H</b> Price gr. <b>A430</b> (pce.)			
dark blue <input type="checkbox"/>	2	<b>759-2008H</b> Price gr. <b>A430</b> (pce.)	<b>761-2008H</b> Price gr. <b>A430</b> (pce.)			
medium turquoise <input type="checkbox"/>	3	<b>759-2011H</b> Price gr. <b>A430</b> (pce.)	<b>761-2011H</b> Price gr. <b>A430</b> (pce.)			
medium green <input type="checkbox"/>	3	<b>759-2015H</b> Price gr. <b>A430</b> (pce.)	<b>761-2015H</b> Price gr. <b>A430</b> (pce.)			
dark green <input type="checkbox"/>	2	<b>759-2016H</b> Price gr. <b>A430</b> (pce.)	<b>761-2016H</b> Price gr. <b>A430</b> (pce.)			
medium yellow <input type="checkbox"/>	3	<b>759-2019H</b> Price gr. <b>A430</b> (pce.)	<b>761-2019H</b> Price gr. <b>A430</b> (pce.)			
medium ochre <input type="checkbox"/>	3	<b>759-2023H</b> Price gr. <b>A430</b> (pce.)	<b>761-2023H</b> Price gr. <b>A430</b> (pce.)			
medium salmon <input type="checkbox"/>	3	<b>759-2027H</b> Price gr. <b>A430</b> (pce.)	<b>761-2027H</b> Price gr. <b>A430</b> (pce.)			
medium oxide red <input type="checkbox"/>	3	<b>759-2031H</b> Price gr. <b>A430</b> (pce.)	<b>761-2031H</b> Price gr. <b>A430</b> (pce.)			
light stone grey <input type="checkbox"/>	4 <b>763-2034H</b> Price gr. <b>A416</b> (pce.)	<b>759-2034H</b> Price gr. <b>A430</b> (pce.)	<b>761-2034H</b> Price gr. <b>A430</b> (pce.)			
dark stone grey <input type="checkbox"/>	2 <b>763-2036H</b> Price gr. <b>A416</b> (pce.)	<b>759-2036H</b> Price gr. <b>A430</b> (pce.)	<b>761-2036H</b> Price gr. <b>A430</b> (pce.)			
active sand-grey <input type="checkbox"/>	2 <b>763-2037H</b> Price gr. <b>A416</b> (pce.)	<b>759-2037H</b> Price gr. <b>A430</b> (pce.)	<b>761-2037H</b> Price gr. <b>A430</b> (pce.)			
dark sand-grey <input type="checkbox"/>	2 <b>763-2040H</b> Price gr. <b>A416</b> (pce.)	<b>759-2040H</b> Price gr. <b>A430</b> (pce.)	<b>761-2040H</b> Price gr. <b>A430</b> (pce.)			

<sup>1</sup> For details, refer to page 536  
Color deviations compared to the adjoining covering due to production are no reason for complaint in case of horizontal laying.



Juice bar "The Juizza" in the opera passage, Vienna, Austria / Architect: Schubert und Schubert ZT-GmbH, Vienna, Austria / Photo: Christoph Panzer







# 360 Plural non-slip stoneware

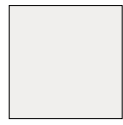

2120/2121  
neutral 10 (active white)



2119  
neutral 9 (white-grey)



2118  
neutral 8 (light-grey)



2117  
neutral 7 (pebble-grey)



2116  
neutral 6 (pearl grey)



2115  
neutral 5 (basalt-grey)



2114  
neutral 4 (graphite-black)



2113  
neutral 3 (asphalt black)



2112  
neutral 2 (anthracite)



2111  
neutral 1 (deep black)



2004  
dark azure



2008  
dark blue



2012  
dark turquoise



2016  
dark green



2020  
dark yellow



2024  
dark ochre



2028  
dark salmon



2032  
dark oxid red



2036  
dark stone grey



2040  
dark sand grey



2003  
medium azure



2007  
medium blue



2011  
medium turquoise



2015  
medium green



2019  
medium yellow



2023  
medium ochre



2027  
medium salmon



2031  
medium oxid red



2035  
medium stone grey



2039  
medium sand grey



2002  
light azure

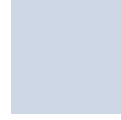

2006  
light blue



2010  
light turquoise



2014  
light green



2018  
light yellow



2022  
light ochre



2026  
light salmon



2030  
light oxid red



2034  
light stone grey



2038  
light sand grey



2001  
active azure



2005  
active blue



2009  
active turquoise



2013  
active green



2017  
active yellow



2021  
active ochre



2025  
active salmon



2029  
active oxid red



2033  
active stone grey



2037  
active sand grey



### Mosaic 2.5 x 2.5 cm, 1 x 1 in

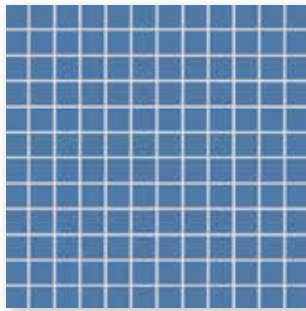

Mosaic sheet 30 x 30 cm, 12 x 12 in,  
smooth, R10/B



Cove skirting  
10 x 10 cm, 4 x 4 in  
smooth, R10/B



Shower tub system Corner  
10 x 10 cm, 4 x 4 in  
smooth, R10/B



Internal  
corner,  
smooth



External  
corner,  
smooth



Shower tub system Strip,  
10 x 10 cm, 4 x 4 in  
smooth, R10/B

### Mosaic 5 x 5 cm, 2 x 2 in

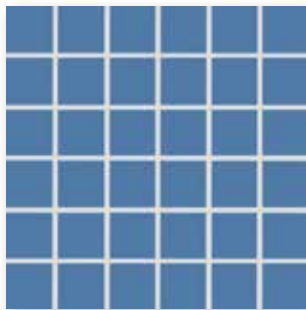

Mosaic sheet 30 x 30 cm, 12 x 12 in,  
smooth, R10/B

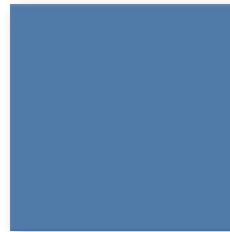

Floor tile 20 x 20 cm, 8 x 8 in,  
smooth, R10/B

### Mosaic 10 x 10 cm, 4 x 4 in

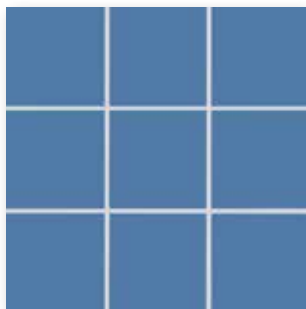

Mosaic sheet 30 x 30 cm, 12 x 12 in,  
smooth, R10/B



Floor tile 30 x 60 cm, 12 x 24 in, smooth, R10/B



Mosaics glued thermoplastically on back of Agrob Buchtal can be used not only in dry zones but also without any problems in underwater areas (e.g. swimming pools/whirlpools) as well as in permanently wet areas (e.g. pool surrounds/showers).

Do you already know our Mosaic Designer at our website [www.agrob-buchtal.com](http://www.agrob-buchtal.com)? There, you will have the possibility of designing your individual color gradients, mosaic compositions and the laying of pictures.

# 362 Plural non-slip stoneware

Dry-pressed Ceramic Tiles, DIN EN 14411, group Bl<sub>1</sub>, glazed (GL) for floor and wall coverings in indoor and outdoor areas (stoneware tiles)// Extruded Ceramic Tiles, Precision, DIN EN 14411, group Al<sub>1</sub>, glazed (GL) for floor and wall coverings in indoor and outdoor areas (stoneware tiles)

## Mosaic<sup>2/4</sup>

2,5 x 2,5 cm

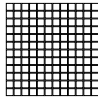

5 x 5 cm

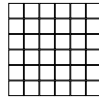

10 x 10 cm

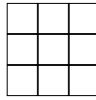

## Wall/Floor Tiles

20 x 20 cm



30 x 60 cm<sup>1/3</sup>



Nom. dim. - cm/in	2.5 x 2.5 / 1 x 1	5 x 5 / 2 x 2	10 x 10 / 4 x 4	20 x 20 / 8 x 8	30 x 60 / 12 x 24
Work size	23 x 23 x 6.5 mm	47 x 47 x 6.5 mm	97 x 97 x 6.5 mm	197 x 197 x 6.5 mm	297 x 597 x 8 mm
Surface	smooth, matt	smooth, matt	smooth, matt	smooth, matt	smooth, matt
m <sup>2</sup> - pieces	11 sheets	11 sheets	11 sheets	25.000	5.556
m <sup>2</sup> - kg	12.100	12.331	13.101	13.875	17.413
Bundle - pieces	11 sheets	11 sheets	11 sheets	25	6
Bundle - m <sup>2</sup>	1.000	1.000	1.000	1.000	1.080
Bundle - kg	12.100	12.331	13.101	13.875	18.804
Pallet - m <sup>2</sup>	48.000	64.000	64.000	72.000	43.197
Pallet - kg	580.800	789.184	838.464	999.000	752.160
Product standard	Blb	Blb	Blb	Blb	Alb
Slip resistance	R10/B	R10/B	R10/B	R10/B	R10/B
Stress group	1	1	1	1	2
Stress group	4	4	4	4	4
neutral 10 (active white)	<b>902-2120H</b> Price gr. <b>A238</b> (m <sup>2</sup> )	<b>905-2120H</b> Price gr. <b>A205</b> (m <sup>2</sup> )	<b>910-2120H</b> Price gr. <b>A166</b> (m <sup>2</sup> )	<b>920-2120H</b> Price gr. <b>A148</b> (m <sup>2</sup> )	<b>980-2120H</b> Price gr. <b>A181</b> (m <sup>2</sup> )
neutral 9 (white grey)	<b>902-2119H<sup>1</sup></b> Price gr. <b>A289</b> (m <sup>2</sup> )	<b>905-2119H<sup>1</sup></b> Price gr. <b>A250</b> (m <sup>2</sup> )	<b>910-2119H</b> Price gr. <b>A190</b> (m <sup>2</sup> )	<b>920-2119H<sup>1</sup></b> Price gr. <b>A190</b> (m <sup>2</sup> )	
neutral 8 (light-grey)	<b>902-2118H</b> Price gr. <b>A238</b> (m <sup>2</sup> )	<b>905-2118H</b> Price gr. <b>A205</b> (m <sup>2</sup> )	<b>910-2118H</b> Price gr. <b>A166</b> (m <sup>2</sup> )	<b>920-2118H</b> Price gr. <b>A148</b> (m <sup>2</sup> )	<b>980-2118H</b> Price gr. <b>A205</b> (m <sup>2</sup> )
neutral 7 (pebble-grey)	<b>902-2117H<sup>1</sup></b> Price gr. <b>A289</b> (m <sup>2</sup> )	<b>905-2117H<sup>1</sup></b> Price gr. <b>A256</b> (m <sup>2</sup> )	<b>910-2117H</b> Price gr. <b>A190</b> (m <sup>2</sup> )	<b>920-2117H<sup>1</sup></b> Price gr. <b>A190</b> (m <sup>2</sup> )	
neutral 6 (pearl-grey)	<b>902-2116H<sup>1</sup></b> Price gr. <b>A289</b> (m <sup>2</sup> )	<b>905-2116H<sup>1</sup></b> Price gr. <b>A256</b> (m <sup>2</sup> )	<b>910-2116H<sup>1</sup></b> Price gr. <b>A223</b> (m <sup>2</sup> )	<b>920-2116H<sup>1</sup></b> Price gr. <b>A190</b> (m <sup>2</sup> )	
neutral 5 (basalt grey)	<b>902-2115H<sup>1</sup></b> Price gr. <b>A289</b> (m <sup>2</sup> )	<b>905-2115H<sup>1</sup></b> Price gr. <b>A256</b> (m <sup>2</sup> )	<b>910-2115H</b> Price gr. <b>A190</b> (m <sup>2</sup> )	<b>920-2115H</b> Price gr. <b>A166</b> (m <sup>2</sup> )	
neutral 4 (graphite black)	<b>902-2114H<sup>1</sup></b> Price gr. <b>A289</b> (m <sup>2</sup> )	<b>905-2114H<sup>1</sup></b> Price gr. <b>A256</b> (m <sup>2</sup> )	<b>910-2114H</b> Price gr. <b>A190</b> (m <sup>2</sup> )	<b>920-2114H</b> Price gr. <b>A166</b> (m <sup>2</sup> )	
neutral 3 (asphalt black)	<b>902-2113H<sup>1</sup></b> Price gr. <b>A289</b> (m <sup>2</sup> )	<b>905-2113H<sup>1</sup></b> Price gr. <b>A256</b> (m <sup>2</sup> )	<b>910-2113H</b> Price gr. <b>A190</b> (m <sup>2</sup> )	<b>920-2113H<sup>1</sup></b> Price gr. <b>A190</b> (m <sup>2</sup> )	
neutral 2 (anthracite)	<b>902-2112H<sup>1</sup></b> Price gr. <b>A289</b> (m <sup>2</sup> )	<b>905-2112H<sup>1</sup></b> Price gr. <b>A256</b> (m <sup>2</sup> )	<b>910-2112H</b> Price gr. <b>A190</b> (m <sup>2</sup> )	<b>920-2112H</b> Price gr. <b>A166</b> (m <sup>2</sup> )	
neutral 1 (deep black)	<b>902-2111H</b> Price gr. <b>A259</b> (m <sup>2</sup> )	<b>905-2111H</b> Price gr. <b>A229</b> (m <sup>2</sup> )	<b>910-2111H</b> Price gr. <b>A190</b> (m <sup>2</sup> )	<b>920-2111H</b> Price gr. <b>A166</b> (m <sup>2</sup> )	<b>980-2111H</b> Price gr. <b>A181</b> (m <sup>2</sup> )
active azure	<b>902-2001H<sup>1</sup></b> Price gr. <b>A289</b> (m <sup>2</sup> )	<b>905-2001H<sup>1</sup></b> Price gr. <b>A256</b> (m <sup>2</sup> )	<b>910-2001H</b> Price gr. <b>A190</b> (m <sup>2</sup> )	<b>920-2001H<sup>1</sup></b> Price gr. <b>A190</b> (m <sup>2</sup> )	
light azure	<b>902-2002H<sup>1</sup></b> Price gr. <b>A289</b> (m <sup>2</sup> )	<b>905-2002H<sup>1</sup></b> Price gr. <b>A256</b> (m <sup>2</sup> )	<b>910-2002H</b> Price gr. <b>A190</b> (m <sup>2</sup> )	<b>920-2002H<sup>1</sup></b> Price gr. <b>A190</b> (m <sup>2</sup> )	
medium azure	<b>902-2003H</b> Price gr. <b>A259</b> (m <sup>2</sup> )	<b>905-2003H</b> Price gr. <b>A229</b> (m <sup>2</sup> )	<b>910-2003H</b> Price gr. <b>A190</b> (m <sup>2</sup> )	<b>920-2003H</b> Price gr. <b>A166</b> (m <sup>2</sup> )	<b>980-2003H</b> Price gr. <b>A205</b> (m <sup>2</sup> )
dark azure	<b>902-2004H</b> Price gr. <b>A259</b> (m <sup>2</sup> )	<b>905-2004H<sup>1</sup></b> Price gr. <b>A256</b> (m <sup>2</sup> )	<b>910-2004H</b> Price gr. <b>A190</b> (m <sup>2</sup> )	<b>920-2004H</b> Price gr. <b>A166</b> (m <sup>2</sup> )	
active blue	<b>902-2005H<sup>1</sup></b> Price gr. <b>A289</b> (m <sup>2</sup> )	<b>905-2005H<sup>1</sup></b> Price gr. <b>A256</b> (m <sup>2</sup> )	<b>910-2005H<sup>1</sup></b> Price gr. <b>A223</b> (m <sup>2</sup> )	<b>920-2005H<sup>1</sup></b> Price gr. <b>A190</b> (m <sup>2</sup> )	
light blue	<b>902-2006H<sup>1</sup></b> Price gr. <b>A289</b> (m <sup>2</sup> )	<b>905-2006H<sup>1</sup></b> Price gr. <b>A256</b> (m <sup>2</sup> )	<b>910-2006H</b> Price gr. <b>A190</b> (m <sup>2</sup> )	<b>920-2006H<sup>1</sup></b> Price gr. <b>A190</b> (m <sup>2</sup> )	
medium blue	<b>902-2007H<sup>1</sup></b> Price gr. <b>A289</b> (m <sup>2</sup> )	<b>905-2007H<sup>1</sup></b> Price gr. <b>A256</b> (m <sup>2</sup> )	<b>910-2007H</b> Price gr. <b>A190</b> (m <sup>2</sup> )	<b>920-2007H</b> Price gr. <b>A166</b> (m <sup>2</sup> )	<b>980-2007H</b> Price gr. <b>A205</b> (m <sup>2</sup> )
dark blue	<b>902-2008H</b> Price gr. <b>A259</b> (m <sup>2</sup> )	<b>905-2008H</b> Price gr. <b>A229</b> (m <sup>2</sup> )	<b>910-2008H</b> Price gr. <b>A190</b> (m <sup>2</sup> )	<b>920-2008H</b> Price gr. <b>A166</b> (m <sup>2</sup> )	
active turquoise	<b>902-2009H<sup>1</sup></b> Price gr. <b>A289</b> (m <sup>2</sup> )	<b>905-2009H<sup>1</sup></b> Price gr. <b>A256</b> (m <sup>2</sup> )	<b>910-2009H<sup>1</sup></b> Price gr. <b>A223</b> (m <sup>2</sup> )	<b>920-2009H<sup>1</sup></b> Price gr. <b>A190</b> (m <sup>2</sup> )	
light turquoise	<b>902-2010H<sup>1</sup></b> Price gr. <b>A289</b> (m <sup>2</sup> )	<b>905-2010H<sup>1</sup></b> Price gr. <b>A256</b> (m <sup>2</sup> )	<b>910-2010H<sup>1</sup></b> Price gr. <b>A223</b> (m <sup>2</sup> )	<b>920-2010H<sup>1</sup></b> Price gr. <b>A190</b> (m <sup>2</sup> )	
medium turquoise	<b>902-2011H<sup>1</sup></b> Price gr. <b>A289</b> (m <sup>2</sup> )	<b>905-2011H<sup>1</sup></b> Price gr. <b>A256</b> (m <sup>2</sup> )	<b>910-2011H</b> Price gr. <b>A190</b> (m <sup>2</sup> )	<b>920-2011H</b> Price gr. <b>A166</b> (m <sup>2</sup> )	<b>980-2011H</b> Price gr. <b>A205</b> (m <sup>2</sup> )
dark turquoise	<b>902-2012H<sup>1</sup></b> Price gr. <b>A289</b> (m <sup>2</sup> )	<b>905-2012H<sup>1</sup></b> Price gr. <b>A256</b> (m <sup>2</sup> )	<b>910-2012H<sup>1</sup></b> Price gr. <b>A223</b> (m <sup>2</sup> )	<b>920-2012H<sup>1</sup></b> Price gr. <b>A190</b> (m <sup>2</sup> )	
active green	<b>902-2013H<sup>1</sup></b> Price gr. <b>A289</b> (m <sup>2</sup> )	<b>905-2013H<sup>1</sup></b> Price gr. <b>A256</b> (m <sup>2</sup> )	<b>910-2013H<sup>1</sup></b> Price gr. <b>A223</b> (m <sup>2</sup> )	<b>920-2013H<sup>1</sup></b> Price gr. <b>A190</b> (m <sup>2</sup> )	
light green	<b>902-2014H<sup>1</sup></b> Price gr. <b>A289</b> (m <sup>2</sup> )	<b>905-2014H</b> Price gr. <b>A229</b> (m <sup>2</sup> )	<b>910-2014H<sup>1</sup></b> Price gr. <b>A223</b> (m <sup>2</sup> )	<b>920-2014H<sup>1</sup></b> Price gr. <b>A190</b> (m <sup>2</sup> )	
medium green	<b>902-2015H<sup>1</sup></b> Price gr. <b>A289</b> (m <sup>2</sup> )	<b>905-2015H<sup>1</sup></b> Price gr. <b>A256</b> (m <sup>2</sup> )	<b>910-2015H</b> Price gr. <b>A190</b> (m <sup>2</sup> )	<b>920-2015H</b> Price gr. <b>A166</b> (m <sup>2</sup> )	<b>980-2015H</b> Price gr. <b>A205</b> (m <sup>2</sup> )
dark green	<b>902-2016H<sup>1</sup></b> Price gr. <b>A289</b> (m <sup>2</sup> )	<b>905-2016H<sup>1</sup></b> Price gr. <b>A256</b> (m <sup>2</sup> )	<b>910-2016H</b> Price gr. <b>A190</b> (m <sup>2</sup> )	<b>920-2016H</b> Price gr. <b>A166</b> (m <sup>2</sup> )	

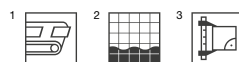

<sup>4</sup> Upon request, defined color gradients and mosaic pictures can also be supplied.

Cove Skirting<sup>1/3</sup>

Internal Corner for Cove Skirting<sup>1/3</sup>

External Corner for Cove Skirting<sup>1/3</sup>

Shower Tub System<sup>2</sup>

10 x 10 cm



10 x 10 cm



10 x 10 cm



					Strip	Corner		
		10 x 10 / 4 x 4	100 x 18 x 6.5 mm	100 x 18 x 6.5 mm	100 x 18 x 6.5 mm	10 x 10 / 4 x 4	10 x 10 / 4 x 4	Nom. dim. - cm/in
		100 x 97 x 6.5 mm	smooth, matt	smooth, matt	smooth, matt	97 x 97 x 6.5 mm	97 x 97 x 6.5 mm	Work size
		10.000	1.500/m	0.030/piece	0.030/piece	10.000	1.700/m	0.170/piece
		40	4.000	40	30	16	1.600	4
		6.000				2.720	0.680	
		B1b	B1b	B1b	B1b	B1b	B1b	
		R10/B	R10/B	R10/B	R10/B	R10/B	R10/B	Product standard
								Slip resistance
		<b>764-2120H</b>	<b>759-2120H</b>	<b>761-2120H</b>	<b>785-2120H</b>	<b>786-2120H</b>		4 neutral 10
		Price gr. A418 (pce.)	Price gr. A430 (pce.)	Price gr. A430 (pce.)	Price gr. A428 (pce.)	Price gr. A455 (pce.)		(active white) <input type="checkbox"/>
		<b>764-2119H</b>	<b>759-2119H</b>	<b>761-2119H</b>	<b>785-2119H</b>	<b>786-2119H</b>		4 neutral 9
		Price gr. A418 (pce.)	Price gr. A430 (pce.)	Price gr. A430 (pce.)	Price gr. A428 (pce.)	Price gr. A455 (pce.)		(white grey) <input type="checkbox"/>
		<b>764-2118H</b>	<b>759-2118H</b>	<b>761-2118H</b>	<b>785-2118H</b>	<b>786-2118H</b>		4 neutral 8
		Price gr. A418 (pce.)	Price gr. A430 (pce.)	Price gr. A430 (pce.)	Price gr. A428 (pce.)	Price gr. A455 (pce.)		(light-grey) <input type="checkbox"/>
		<b>764-2117H</b>	<b>759-2117H</b>	<b>761-2117H</b>	<b>785-2117H</b>	<b>786-2117H</b>		4 neutral 7
		Price gr. A418 (pce.)	Price gr. A430 (pce.)	Price gr. A430 (pce.)	Price gr. A428 (pce.)	Price gr. A455 (pce.)		(pebble-grey) <input type="checkbox"/>
		<b>764-2115H</b>	<b>759-2115H</b>	<b>761-2115H</b>	<b>785-2115H</b>	<b>786-2115H</b>		3 neutral 5
		Price gr. A418 (pce.)	Price gr. A430 (pce.)	Price gr. A430 (pce.)	Price gr. A428 (pce.)	Price gr. A455 (pce.)		(basalt grey) <input type="checkbox"/>
		<b>764-2113H</b>	<b>759-2113H</b>	<b>761-2113H</b>	<b>785-2113H</b>	<b>786-2113H</b>		3 neutral 3
		Price gr. A418 (pce.)	Price gr. A430 (pce.)	Price gr. A430 (pce.)	Price gr. A428 (pce.)	Price gr. A455 (pce.)		(asphalt black) <input type="checkbox"/>
		<b>764-2111H</b>	<b>759-2111H</b>	<b>761-2111H</b>	<b>785-2111H</b>	<b>786-2111H</b>		1 neutral 1
		Price gr. A418 (pce.)	Price gr. A430 (pce.)	Price gr. A430 (pce.)	Price gr. A428 (pce.)	Price gr. A455 (pce.)		(deep black) <input type="checkbox"/>
		<b>764-2001H</b>	<b>759-2001H</b>	<b>761-2001H</b>	<b>785-2001H</b>	<b>786-2001H</b>		2 active azure
		Price gr. A418 (pce.)	Price gr. A430 (pce.)	Price gr. A430 (pce.)	Price gr. A428 (pce.)	Price gr. A455 (pce.)		<input type="checkbox"/>
		<b>764-2002H</b>	<b>759-2002H</b>	<b>761-2002H</b>	<b>785-2002H</b>	<b>786-2002H</b>		4 light azure
		Price gr. A418 (pce.)	Price gr. A430 (pce.)	Price gr. A430 (pce.)	Price gr. A428 (pce.)	Price gr. A455 (pce.)		<input type="checkbox"/>
		<b>764-2003H</b>	<b>759-2003H</b>	<b>761-2003H</b>	<b>785-2003H</b>	<b>786-2003H</b>		3 medium azure
		Price gr. A418 (pce.)	Price gr. A430 (pce.)	Price gr. A430 (pce.)	Price gr. A428 (pce.)	Price gr. A455 (pce.)		<input type="checkbox"/>
		<b>764-2004H</b>	<b>759-2004H</b>	<b>761-2004H</b>	<b>785-2004H</b>	<b>786-2004H</b>		2 dark azure
		Price gr. A418 (pce.)	Price gr. A430 (pce.)	Price gr. A430 (pce.)	Price gr. A428 (pce.)	Price gr. A455 (pce.)		<input type="checkbox"/>
		<b>764-2006H</b>	<b>759-2006H</b>	<b>761-2006H</b>	<b>785-2006H</b>	<b>786-2006H</b>		4 light blue
		Price gr. A418 (pce.)	Price gr. A430 (pce.)	Price gr. A430 (pce.)	Price gr. A428 (pce.)	Price gr. A455 (pce.)		<input type="checkbox"/>
		<b>764-2007H</b>	<b>759-2007H</b>	<b>761-2007H</b>	<b>785-2007H</b>	<b>786-2007H</b>		3 medium blue
		Price gr. A418 (pce.)	Price gr. A430 (pce.)	Price gr. A430 (pce.)	Price gr. A428 (pce.)	Price gr. A455 (pce.)		<input type="checkbox"/>
		<b>764-2008H</b>	<b>759-2008H</b>	<b>761-2008H</b>	<b>785-2008H</b>	<b>786-2008H</b>		2 dark blue
		Price gr. A418 (pce.)	Price gr. A430 (pce.)	Price gr. A430 (pce.)	Price gr. A428 (pce.)	Price gr. A455 (pce.)		<input type="checkbox"/>
		<b>764-2011H</b>	<b>759-2011H</b>	<b>761-2011H</b>	<b>785-2011H</b>	<b>786-2011H</b>		3 medium turquoise
		Price gr. A418 (pce.)	Price gr. A430 (pce.)	Price gr. A430 (pce.)	Price gr. A428 (pce.)	Price gr. A455 (pce.)		<input type="checkbox"/>
		<b>764-2015H</b>	<b>759-2015H</b>	<b>761-2015H</b>	<b>785-2015H</b>	<b>786-2015H</b>		3 medium green
		Price gr. A418 (pce.)	Price gr. A430 (pce.)	Price gr. A430 (pce.)	Price gr. A428 (pce.)	Price gr. A455 (pce.)		<input type="checkbox"/>
		<b>764-2016H</b>	<b>759-2016H</b>	<b>761-2016H</b>	<b>785-2016H</b>	<b>786-2016H</b>		2 dark green
		Price gr. A418 (pce.)	Price gr. A430 (pce.)	Price gr. A430 (pce.)	Price gr. A428 (pce.)	Price gr. A455 (pce.)		<input type="checkbox"/>

<sup>1</sup> For details, refer to page 536

<sup>2</sup> For details, refer to page 534

<sup>3</sup> Color deviations compared to the adjoining covering due to production are no reason for complaint in case of horizontal laying.



# 364 Plural non-slip stoneware

Dry-pressed Ceramic Tiles, DIN EN 14411, group Bl<sub>1</sub>, glazed (GL) for floor and wall coverings in indoor and outdoor areas (stoneware tiles)// Extruded Ceramic Tiles, Precision, DIN EN 14411, group Al<sub>1</sub>, glazed (GL) for floor and wall coverings in indoor and outdoor areas (stoneware tiles)

## Mosaic<sup>2/4</sup>

2,5 x 2,5 cm

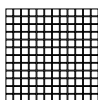

5 x 5 cm

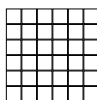

10 x 10 cm

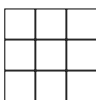

## Wall/Floor Tiles

20 x 20 cm



30 x 60 cm<sup>1/3</sup>

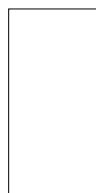

Sheet: 297 x 297 mm

Sheet: 297 x 297 mm

Sheet: 297 x 297 mm

Nom. dim. - cm/in	2.5 x 2.5 / 1 x 1	5 x 5 / 2 x 2	10 x 10 / 4 x 4	20 x 20 / 8 x 8	30 x 60 / 12 x 24		
Work size	23 x 23 x 6.5 mm	47 x 47 x 6.5 mm	97 x 97 x 6.5 mm	197 x 197 x 6.5 mm	297 x 597 x 8 mm		
Surface	smooth, matt	smooth, matt	smooth, matt	smooth, matt	smooth, matt		
m <sup>2</sup> - pieces	11 sheets	11 sheets	11 sheets	25.000	5.556		
m <sup>2</sup> - kg	12.100	12.331	13.101	13.875	17.413		
Bundle - pieces	11 sheets	11 sheets	11 sheets	25	6		
Bundle - m <sup>2</sup>	1.000	1.000	1.000	1.000	1.080		
Bundle - kg	12.100	12.331	13.101	13.875	18.804		
Pallet - m <sup>2</sup>	48.000	64.000	64.000	72.000	43.197		
Pallet - kg	580.800	789.184	838.464	999.000	752.160		
Product standard	Blb	Blb	Blb	Blb	Alb		
Slip resistance	R10/B	R10/B	R10/B	R10/B	R10/B		
Stress group	1	1	1	1	2		
active yellow <input type="checkbox"/>	2 902-2017H <sup>1</sup> Price gr. A289 (m <sup>2</sup> )	905-2017H <sup>1</sup> Price gr. A256 (m <sup>2</sup> )	910-2017H <sup>1</sup> Price gr. A223 (m <sup>2</sup> )	920-2017H <sup>1</sup> Price gr. A190 (m <sup>2</sup> )			
light yellow <input type="checkbox"/>	4 902-2018H <sup>1</sup> Price gr. A289 (m <sup>2</sup> )	905-2018H <sup>1</sup> Price gr. A256 (m <sup>2</sup> )	910-2018H <sup>1</sup> Price gr. A223 (m <sup>2</sup> )	920-2018H <sup>1</sup> Price gr. A190 (m <sup>2</sup> )			
medium yellow <input type="checkbox"/>	3 902-2019H <sup>1</sup> Price gr. A289 (m <sup>2</sup> )	905-2019H <sup>1</sup> Price gr. A256 (m <sup>2</sup> )	910-2019H Price gr. A190 (m <sup>2</sup> )	920-2019H Price gr. A166 (m <sup>2</sup> )	980-2019H Price gr. A205 (m <sup>2</sup> )		
dark yellow <input type="checkbox"/>	2 902-2020H <sup>1</sup> Price gr. A289 (m <sup>2</sup> )	905-2020H <sup>1</sup> Price gr. A256 (m <sup>2</sup> )	910-2020H <sup>1</sup> Price gr. A223 (m <sup>2</sup> )	920-2020H <sup>1</sup> Price gr. A190 (m <sup>2</sup> )			
active ochre <input type="checkbox"/>	2 902-2021H <sup>1</sup> Price gr. A289 (m <sup>2</sup> )	905-2021H <sup>1</sup> Price gr. A256 (m <sup>2</sup> )	910-2021H <sup>1</sup> Price gr. A223 (m <sup>2</sup> )	920-2021H <sup>1</sup> Price gr. A190 (m <sup>2</sup> )			
light ochre <input type="checkbox"/>	4 902-2022H <sup>1</sup> Price gr. A289 (m <sup>2</sup> )	905-2022H <sup>1</sup> Price gr. A256 (m <sup>2</sup> )	910-2022H Price gr. A190 (m <sup>2</sup> )	920-2022H <sup>1</sup> Price gr. A190 (m <sup>2</sup> )			
medium ochre <input type="checkbox"/>	3 902-2023H <sup>1</sup> Price gr. A289 (m <sup>2</sup> )	905-2023H <sup>1</sup> Price gr. A256 (m <sup>2</sup> )	910-2023H Price gr. A190 (m <sup>2</sup> )	920-2023H Price gr. A166 (m <sup>2</sup> )	980-2023H Price gr. A205 (m <sup>2</sup> )		
dark ochre <input type="checkbox"/>	2 902-2024H <sup>1</sup> Price gr. A289 (m <sup>2</sup> )	905-2024H <sup>1</sup> Price gr. A256 (m <sup>2</sup> )	910-2024H <sup>1</sup> Price gr. A223 (m <sup>2</sup> )	920-2024H <sup>1</sup> Price gr. A190 (m <sup>2</sup> )			
active salmon <input type="checkbox"/>	2 902-2025H <sup>1</sup> Price gr. A289 (m <sup>2</sup> )	905-2025H <sup>1</sup> Price gr. A256 (m <sup>2</sup> )	910-2025H <sup>1</sup> Price gr. A223 (m <sup>2</sup> )	920-2025H <sup>1</sup> Price gr. A190 (m <sup>2</sup> )			
light salmon <input type="checkbox"/>	4 902-2026H <sup>1</sup> Price gr. A289 (m <sup>2</sup> )	905-2026H <sup>1</sup> Price gr. A256 (m <sup>2</sup> )	910-2026H <sup>1</sup> Price gr. A223 (m <sup>2</sup> )	920-2026H <sup>1</sup> Price gr. A190 (m <sup>2</sup> )			
medium salmon <input type="checkbox"/>	3 902-2027H <sup>1</sup> Price gr. A289 (m <sup>2</sup> )	905-2027H Price gr. A229 (m <sup>2</sup> )	910-2027H Price gr. A190 (m <sup>2</sup> )	920-2027H Price gr. A166 (m <sup>2</sup> )	980-2027H Price gr. A205 (m <sup>2</sup> )		
dark salmon <input type="checkbox"/>	2 902-2028H <sup>1</sup> Price gr. A289 (m <sup>2</sup> )	905-2028H <sup>1</sup> Price gr. A256 (m <sup>2</sup> )	910-2028H <sup>1</sup> Price gr. A223 (m <sup>2</sup> )	920-2028H Price gr. A166 (m <sup>2</sup> )			
active oxide red <input type="checkbox"/>	2 902-2029H <sup>1</sup> Price gr. A289 (m <sup>2</sup> )	905-2029H Price gr. A229 (m <sup>2</sup> )	910-2029H <sup>1</sup> Price gr. A223 (m <sup>2</sup> )	920-2029H <sup>1</sup> Price gr. A190 (m <sup>2</sup> )			
light oxide red <input type="checkbox"/>	4 902-2030H <sup>1</sup> Price gr. A289 (m <sup>2</sup> )	905-2030H <sup>1</sup> Price gr. A256 (m <sup>2</sup> )	910-2030H <sup>1</sup> Price gr. A223 (m <sup>2</sup> )	920-2030H <sup>1</sup> Price gr. A190 (m <sup>2</sup> )			
medium oxide red <input type="checkbox"/>	3 902-2031H <sup>1</sup> Price gr. A289 (m <sup>2</sup> )	905-2031H <sup>1</sup> Price gr. A256 (m <sup>2</sup> )	910-2031H Price gr. A190 (m <sup>2</sup> )	920-2031H Price gr. A166 (m <sup>2</sup> )	980-2031H Price gr. A205 (m <sup>2</sup> )		
dark oxide red <input type="checkbox"/>	2 902-2032H <sup>1</sup> Price gr. A289 (m <sup>2</sup> )	905-2032H <sup>1</sup> Price gr. A256 (m <sup>2</sup> )	910-2032H <sup>1</sup> Price gr. A223 (m <sup>2</sup> )	920-2032H <sup>1</sup> Price gr. A190 (m <sup>2</sup> )			
active stone grey <input type="checkbox"/>	2 902-2033H <sup>1</sup> Price gr. A289 (m <sup>2</sup> )	905-2033H <sup>1</sup> Price gr. A256 (m <sup>2</sup> )	910-2033H Price gr. A190 (m <sup>2</sup> )	920-2033H <sup>1</sup> Price gr. A190 (m <sup>2</sup> )			
light stone grey <input type="checkbox"/>	4 902-2034H <sup>1</sup> Price gr. A289 (m <sup>2</sup> )	905-2034H <sup>1</sup> Price gr. A256 (m <sup>2</sup> )	910-2034H Price gr. A190 (m <sup>2</sup> )	920-2034H <sup>1</sup> Price gr. A190 (m <sup>2</sup> )			
medium stone grey <input type="checkbox"/>	3 902-2035H <sup>1</sup> Price gr. A289 (m <sup>2</sup> )	905-2035H <sup>1</sup> Price gr. A256 (m <sup>2</sup> )	910-2035H Price gr. A190 (m <sup>2</sup> )	920-2035H Price gr. A190 (m <sup>2</sup> )			
dark stone grey <input type="checkbox"/>	2 902-2036H <sup>1</sup> Price gr. A259 (m <sup>2</sup> )	905-2036H Price gr. A229 (m <sup>2</sup> )	910-2036H Price gr. A190 (m <sup>2</sup> )	920-2036H Price gr. A166 (m <sup>2</sup> )			
active sand-grey <input type="checkbox"/>	2 902-2037H <sup>1</sup> Price gr. A289 (m <sup>2</sup> )	905-2037H <sup>1</sup> Price gr. A256 (m <sup>2</sup> )	910-2037H Price gr. A190 (m <sup>2</sup> )	920-2037H <sup>1</sup> Price gr. A190 (m <sup>2</sup> )			
light sand-grey <input type="checkbox"/>	4 902-2038H <sup>1</sup> Price gr. A289 (m <sup>2</sup> )	905-2038H Price gr. A229 (m <sup>2</sup> )	910-2038H Price gr. A190 (m <sup>2</sup> )	920-2038H Price gr. A166 (m <sup>2</sup> )			
medium sand-grey <input type="checkbox"/>	3 902-2039H <sup>1</sup> Price gr. A289 (m <sup>2</sup> )	905-2039H Price gr. A229 (m <sup>2</sup> )	910-2039H Price gr. A190 (m <sup>2</sup> )	920-2039H Price gr. A166 (m <sup>2</sup> )	980-2039H Price gr. A205 (m <sup>2</sup> )		
dark sand-grey <input type="checkbox"/>	2 902-2040H Price gr. A259 (m <sup>2</sup> )	905-2040H Price gr. A229 (m <sup>2</sup> )	910-2040H Price gr. A190 (m <sup>2</sup> )	920-2040H Price gr. A166 (m <sup>2</sup> )			

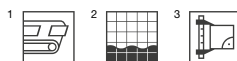

<sup>4</sup> Upon request, defined color gradients and mosaic pictures can also be supplied.

Cove Skirting<sup>1/3</sup>

10 x 10 cm



Internal Corner for Cove Skirting<sup>1/3</sup>



External Corner for Cove Skirting<sup>1/3</sup>



Shower Tub System<sup>2</sup>

10 x 10 cm



10 x 10 cm



					Strip	Corner	
	10 x 10 / 4 x 4	100 x 18 x 6.5 mm	100 x 18 x 6.5 mm	100 x 18 x 6.5 mm	10 x 10 / 4 x 4	10 x 10 / 4 x 4	
	100 x 97 x 6.5 mm	100 x 97 x 6.5 mm	100 x 97 x 6.5 mm	100 x 97 x 6.5 mm	97 x 97 x 6.5 mm	97 x 97 x 6.5 mm	Nom. dim. - cm/in
	smooth, matt	smooth, matt	smooth, matt	smooth, matt	smooth, matt	smooth, matt	Work size
	10.000				10.000		Surface
	1.500/m	0.030/piece	0.030/piece	1.700/m	0.170/piece		m - pieces
	40	40	30	16	4		m/pce. - kg
	4.000			1.600			Bundle - pieces
	6.000			2.720	0.680		Bundle - m
							Bundle - kg
							Pallet - m
							Pallet - kg
	Blb	Blb	Blb	Blb	Blb	Blb	Product standard
	R10/B			R10/B	R10/B		Slip resistance
							Stress group
	<b>764-2019H</b>	<b>759-2019H</b>	<b>761-2019H</b>	<b>785-2019H</b>	<b>786-2019H</b>		3
	Price gr. <b>A418</b> (pce.)	Price gr. <b>A430</b> (pce.)	Price gr. <b>A430</b> (pce.)	Price gr. <b>A428</b> (pce.)	Price gr. <b>A455</b> (pce.)		medium yellow
	<b>764-2023H</b>	<b>759-2023H</b>	<b>761-2023H</b>	<b>785-2023H</b>	<b>786-2023H</b>		3
	Price gr. <b>A418</b> (pce.)	Price gr. <b>A430</b> (pce.)	Price gr. <b>A430</b> (pce.)	Price gr. <b>A428</b> (pce.)	Price gr. <b>A455</b> (pce.)		medium ochre
	<b>764-2027H</b>	<b>759-2027H</b>	<b>761-2027H</b>	<b>785-2027H</b>	<b>786-2027H</b>		3
	Price gr. <b>A418</b> (pce.)	Price gr. <b>A430</b> (pce.)	Price gr. <b>A430</b> (pce.)	Price gr. <b>A428</b> (pce.)	Price gr. <b>A455</b> (pce.)		medium salmon
	<b>764-2031H</b>	<b>759-2031H</b>	<b>761-2031H</b>	<b>785-2031H</b>	<b>786-2031H</b>		3
	Price gr. <b>A418</b> (pce.)	Price gr. <b>A430</b> (pce.)	Price gr. <b>A430</b> (pce.)	Price gr. <b>A428</b> (pce.)	Price gr. <b>A455</b> (pce.)		medium oxide red
	<b>764-2034H</b>	<b>759-2034H</b>	<b>761-2034H</b>	<b>785-2034H</b>	<b>786-2034H</b>		4
	Price gr. <b>A418</b> (pce.)	Price gr. <b>A430</b> (pce.)	Price gr. <b>A430</b> (pce.)	Price gr. <b>A428</b> (pce.)	Price gr. <b>A455</b> (pce.)		light stone grey
	<b>764-2036H</b>	<b>759-2036H</b>	<b>761-2036H</b>	<b>785-2036H</b>	<b>786-2036H</b>		2
	Price gr. <b>A418</b> (pce.)	Price gr. <b>A430</b> (pce.)	Price gr. <b>A430</b> (pce.)	Price gr. <b>A428</b> (pce.)	Price gr. <b>A455</b> (pce.)		dark stone grey
	<b>764-2037H</b>	<b>759-2037H</b>	<b>761-2037H</b>	<b>785-2037H</b>	<b>786-2037H</b>		2
	Price gr. <b>A418</b> (pce.)	Price gr. <b>A430</b> (pce.)	Price gr. <b>A430</b> (pce.)	Price gr. <b>A428</b> (pce.)	Price gr. <b>A455</b> (pce.)		active sand-grey
	<b>764-2040H</b>	<b>759-2040H</b>	<b>761-2040H</b>	<b>785-2040H</b>	<b>786-2040H</b>		2
	Price gr. <b>A418</b> (pce.)	Price gr. <b>A430</b> (pce.)	Price gr. <b>A430</b> (pce.)	Price gr. <b>A428</b> (pce.)	Price gr. <b>A455</b> (pce.)		dark sand-grey

<sup>1</sup> For details, refer to page 536

<sup>2</sup> For details, refer to page 534

<sup>3</sup> Color deviations compared to the adjoining covering due to production are no reason for complaint in case of horizontal laying.



Hauswirtschaftsschule (home economics school), Sankt Gallen, Switzerland / Architect: Architekturbüro Daniel Cavelti, Photo: Adriano Faragulo





368 Plural unglazed  
porcelain stoneware



R10/B R11/C



2008  
dark blue



2040  
dark sand grey



2016  
dark green



2041  
medium brown



2023  
medium ochre



2042  
medium grey



2033  
active stone grey



2043  
medium sand beige

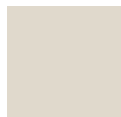

2038  
sand-white



2111  
neutral 1 (deep black)



2039  
medium sand grey



2113  
neutral 3 (asphalt black)



### Mosaic 2.5 x 2.5 cm, 1 x 1 in

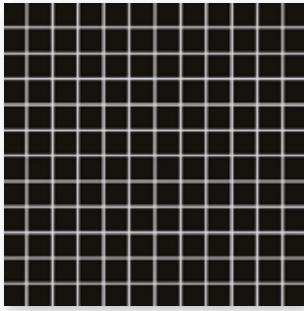

Mosaic sheet 30 x 30 cm, 12 x 12 in, smooth, R10/B



Floor tile 15 x 15 cm, 6 x 6 in, smooth, R10/B  
Floor tile 15 x 15 cm, 6 x 6 in, relief, R11/C



Cove skirting  
10 x 10 cm, 4 x 4 in, smooth, R10/B



Shower tub system Corner  
10 x 10 cm, 4 x 4 in, smooth, R10/B

### Mosaic 5 x 5 cm, 2 x 2 in

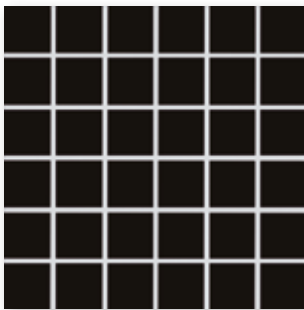

Mosaic sheet 30 x 30 cm, 12 x 12 in, smooth, R10/B



Floor tile 20 x 20 cm, 8 x 8 in, smooth, R10/B



Shower tub system Strip  
10 x 10 cm, 4 x 4 in, smooth, R10/B

### Mosaic 10 x 10 cm, 4 x 4 in

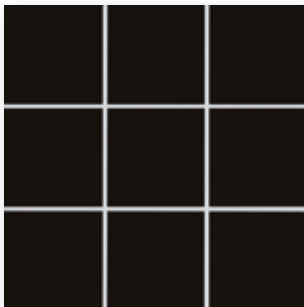

Mosaic sheet 30 x 30 cm, 12 x 12 in, smooth, R10/B  
Mosaic sheet 30 x 30 cm, 12 x 12 in, relief, R11/C



Floor tile 30 x 60 cm, 12 x 24 in, smooth, R10/B



Mosaics glued thermoplastically on back of Agrob Buchtal can be used not only in dry zones but also without any problems in underwater areas (e.g. swimming pools/whirlpools) as well as in permanently wet areas (e.g. pool surrounds/showers).

# 370 Plural unglazed porcelain stoneware

Dry-pressed Ceramic Tiles, DIN EN 14411, group BI<sub>a</sub>, unglazed (UGL)  
for floor and wall coverings in indoor and outdoor areas (porcelain stoneware tiles)

## Mosaic<sup>2/3</sup>

## Floor Tiles



protected

2,5 x 2,5 cm

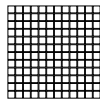

Sheet: 297 x 297 mm

5 x 5 cm

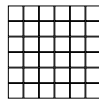

Sheet: 297 x 297 mm

10 x 10 cm

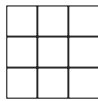

Sheet: 297 x 297 mm

10 x 10 cm

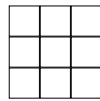

Sheet: 297 x 297 mm

15 x 15 cm



15 x 15 cm



Nom. dim. - cm/in	2.5 x 2.5 / 1 x 1	5 x 5 / 2 x 2	10 x 10 / 4 x 4	10 x 10 / 4 x 4	15 x 15 / 6 x 6	15 x 15 / 6 x 6
Work size	23 x 23 x 6.5 mm	47 x 47 x 6.5 mm	97 x 97 x 6.5 mm	97 x 97 x 6.5 mm	147 x 147 x 6.5 mm	147 x 147 x 6.5 mm
Surface	smooth, matt	smooth, matt	smooth, matt	relief, matt	smooth, matt	relief, matt
m <sup>2</sup> - pieces	11 sheets	11 sheets	11 sheets	11 sheets	44.000	44.000
m <sup>2</sup> - kg	12.100	12.331	13.101	13.101	13.816	13.816
Bundle - pieces	11 sheets	11 sheets	11 sheets	11 sheets	44	44
Bundle - m <sup>2</sup>	1.000	1.000	1.000	1.000	1.000	1.000
Bundle - kg	12.100	12.331	13.101	13.101	13.816	13.816
Pallet - m <sup>2</sup>	48.000	64.000	64.000	64.000	80.000	80.000
Pallet - kg	580.800	789.184	838.464	838.464	1,105.280	1,105.280
Product standard	Bla	Bla	Bla	Bla	Bla	Bla
Slip resistance	R10/B	R10/B	R10/B	R11/C	R10/B	R11/C
Stress group	1	1	1	1	1	1
neutral 3	<b>410-2113</b>	<b>610-2113</b>	<b>810-2113</b>	<b>811-2113</b>	<b>812-2113</b>	<b>813-2113</b>
(asphalt black) <input type="checkbox"/>	Price gr. <b>A199</b> (m <sup>2</sup> )	Price gr. <b>A175</b> (m <sup>2</sup> )	Price gr. <b>A136</b> (m <sup>2</sup> )	Price gr. <b>A166</b> (m <sup>2</sup> )	Price gr. <b>A127</b> (m <sup>2</sup> )	Price gr. <b>A148</b> (m <sup>2</sup> )
neutral 1	<b>410-2111</b>	<b>610-2111</b>	<b>810-2111</b>	<b>811-2111</b>	<b>812-2111</b>	<b>813-2111</b>
(deep black) <input type="checkbox"/>	Price gr. <b>A199</b> (m <sup>2</sup> )	Price gr. <b>A175</b> (m <sup>2</sup> )	Price gr. <b>A136</b> (m <sup>2</sup> )	Price gr. <b>A166</b> (m <sup>2</sup> )	Price gr. <b>A127</b> (m <sup>2</sup> )	Price gr. <b>A148</b> (m <sup>2</sup> )
dark blue <input type="checkbox"/>	<b>410-2008</b>	<b>610-2008</b>	<b>810-2008</b>		<b>812-2008</b> <sup>1</sup> <b>NEW</b>	
	Price gr. <b>A238</b> (m <sup>2</sup> )	Price gr. <b>A211</b> (m <sup>2</sup> )	Price gr. <b>A175</b> (m <sup>2</sup> )		Price gr. <b>A160</b> (m <sup>2</sup> )	
dark green <input type="checkbox"/>	<b>410-2016</b> <sup>1</sup> <b>NEW</b>	<b>610-2016</b>	<b>810-2016</b>		<b>812-2016</b> <sup>1</sup> <b>NEW</b>	
	Price gr. <b>A253</b> (m <sup>2</sup> )	Price gr. <b>A211</b> (m <sup>2</sup> )	Price gr. <b>A175</b> (m <sup>2</sup> )		Price gr. <b>A160</b> (m <sup>2</sup> )	
medium ochre <input type="checkbox"/>	<b>410-2023</b>	<b>610-2023</b>	<b>810-2023</b>		<b>812-2023</b> <sup>1</sup> <b>NEW</b>	
	Price gr. <b>A238</b> (m <sup>2</sup> )	Price gr. <b>A211</b> (m <sup>2</sup> )	Price gr. <b>A175</b> (m <sup>2</sup> )		Price gr. <b>A160</b> (m <sup>2</sup> )	
active stone grey <input type="checkbox"/>	<b>410-2033</b> <sup>1</sup> <b>NEW</b>	<b>610-2033</b>	<b>810-2033</b>		<b>812-2033</b> <sup>1</sup> <b>NEW</b>	
	Price gr. <b>A253</b> (m <sup>2</sup> )	Price gr. <b>A211</b> (m <sup>2</sup> )	Price gr. <b>A175</b> (m <sup>2</sup> )		Price gr. <b>A160</b> (m <sup>2</sup> )	
sand-white <input type="checkbox"/>	<b>410-2038</b>	<b>610-2038</b>	<b>810-2038</b>	<b>811-2038</b>	<b>812-2038</b>	<b>813-2038</b>
medium	Price gr. <b>A199</b> (m <sup>2</sup> )	Price gr. <b>A175</b> (m <sup>2</sup> )	Price gr. <b>A136</b> (m <sup>2</sup> )	Price gr. <b>A166</b> (m <sup>2</sup> )	Price gr. <b>A127</b> (m <sup>2</sup> )	Price gr. <b>A148</b> (m <sup>2</sup> )
sand-grey <input type="checkbox"/>	<b>410-2039</b>	<b>610-2039</b>	<b>810-2039</b>		<b>812-2039</b> <sup>1</sup> <b>NEW</b>	
	Price gr. <b>A199</b> (m <sup>2</sup> )	Price gr. <b>A175</b> (m <sup>2</sup> )	Price gr. <b>A136</b> (m <sup>2</sup> )		Price gr. <b>A148</b> (m <sup>2</sup> )	
dark sand-grey <input type="checkbox"/>	<b>410-2040</b>	<b>610-2040</b>	<b>810-2040</b>		<b>812-2040</b> <sup>1</sup> <b>NEW</b>	
	Price gr. <b>A199</b> (m <sup>2</sup> )	Price gr. <b>A175</b> (m <sup>2</sup> )	Price gr. <b>A136</b> (m <sup>2</sup> )		Price gr. <b>A148</b> (m <sup>2</sup> )	
medium brown <input type="checkbox"/>	<b>410-2041</b>	<b>610-2041</b>	<b>810-2041</b>		<b>812-2041</b> <sup>1</sup> <b>NEW</b>	
	Price gr. <b>A238</b> (m <sup>2</sup> )	Price gr. <b>A211</b> (m <sup>2</sup> )	Price gr. <b>A175</b> (m <sup>2</sup> )		Price gr. <b>A148</b> (m <sup>2</sup> )	
medium grey <input type="checkbox"/>	<b>410-2042</b>	<b>610-2042</b>	<b>810-2042</b>	<b>811-2042</b>	<b>812-2042</b>	<b>813-2042</b>
	Price gr. <b>A238</b> (m <sup>2</sup> )	Price gr. <b>A211</b> (m <sup>2</sup> )	Price gr. <b>A175</b> (m <sup>2</sup> )	Price gr. <b>A181</b> (m <sup>2</sup> )	Price gr. <b>A154</b> (m <sup>2</sup> )	Price gr. <b>A175</b> (m <sup>2</sup> )
medium	<b>410-2043</b>	<b>610-2043</b>	<b>810-2043</b>		<b>812-2043</b> <sup>1</sup> <b>NEW</b>	
sand beige <input type="checkbox"/>	Price gr. <b>A238</b> (m <sup>2</sup> )	Price gr. <b>A211</b> (m <sup>2</sup> )	Price gr. <b>A175</b> (m <sup>2</sup> )		Price gr. <b>A160</b> (m <sup>2</sup> )	

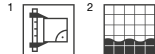

<sup>3</sup> Upon request, defined color gradients and mosaic pictures can also be supplied.

Floor Tiles

20 x 20 cm



30 x 60 cm<sup>1</sup>

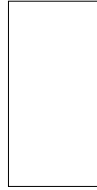

Cove Skirting<sup>3/4</sup>

10 x 10 cm



Shower Tub System<sup>2</sup>

10 x 10 cm



10 x 10 cm



		20 x 20 / 8 x 8	30 x 60 / 12 x 24	10 x 10 / 4 x 4	Strip 10 x 10 / 4 x 4	Corner 10 x 10 / 4 x 4	
		197 x 197 x 6.5 mm	297 x 597 x 6 mm	100 x 97 x 6.5 mm	97 x 97 x 6.5 mm	97 x 97 x 6.5 mm	Nom. dim. - cm/in
		smooth, matt	smooth, matt	smooth, matt	smooth, matt	smooth, matt	Work size
		25.000/m <sup>2</sup>	5.556/m <sup>2</sup>	10.000/m	10.000/m		Surface
		13.875/m <sup>2</sup>	13.273/m <sup>2</sup>	1.500/m	1.700/m	0.170/piece	m <sup>2</sup> /m - pieces
		25	10	40	16	4	m <sup>2</sup> /pce. - kg
		1.000 m <sup>2</sup>	1.800/m <sup>2</sup>	4.000 m	1.600 m		Bundle - pieces
		13.875	23.890	6.000	2.720	0.680	Bundle - m <sup>2</sup> /m
		72.000	71.994				Bundle - kg
		999.000	955.600				Pallet - m <sup>2</sup>
		Bla	Bla	Bla	Bla	Bla	Pallet - kg
		R10/B	R10/B	R10/B	R10/B	R10/B	Product standard
		1	1				Slip resistance
		<b>815-2113</b>	<b>806-2113</b>	<b>864-2113</b>	<b>885-2113</b>	<b>886-2113</b>	Stress group
		Price gr. <b>A115</b> (m <sup>2</sup> )	Price gr. <b>A121</b> (m <sup>2</sup> )	Price gr. <b>A419</b> (pce.)	Price gr. <b>A445</b> (pce.)	Price gr. <b>A475</b> (pce.)	neutral 3
		<b>815-2111</b>	<b>806-2111</b>	<b>864-2111</b>	<b>885-2111</b>	<b>886-2111</b>	(asphalt black) <input type="checkbox"/> VO
		Price gr. <b>A115</b> (m <sup>2</sup> )	Price gr. <b>A121</b> (m <sup>2</sup> )	Price gr. <b>A419</b> (pce.)	Price gr. <b>A445</b> (pce.)	Price gr. <b>A475</b> (pce.)	neutral 1
		<b>815-2008</b>		<b>864-2008</b>	<b>885-2008</b>	<b>886-2008</b>	(deep black) <input type="checkbox"/> VO
		Price gr. <b>A148</b> (m <sup>2</sup> )		Price gr. <b>A419</b> (pce.)	Price gr. <b>A445</b> (pce.)	Price gr. <b>A475</b> (pce.)	dark blue <input type="checkbox"/> VO
		<b>815-2016<sup>1</sup> NEW</b>		<b>864-2016</b>			dark green <input type="checkbox"/> VO
		Price gr. <b>A160</b> (m <sup>2</sup> )		Price gr. <b>A419</b> (pce.)			dark green <input type="checkbox"/> VO
		<b>815-2023</b>		<b>864-2023</b>	<b>885-2023</b>	<b>886-2023</b>	medium ochre <input type="checkbox"/> VO
		Price gr. <b>A148</b> (m <sup>2</sup> )		Price gr. <b>A419</b> (pce.)	Price gr. <b>A445</b> (pce.)	Price gr. <b>A475</b> (pce.)	medium ochre <input type="checkbox"/> VO
		<b>815-2033<sup>1</sup> NEW</b>		<b>864-2033</b>			active stone grey <input type="checkbox"/> VO
		Price gr. <b>A160</b> (m <sup>2</sup> )		Price gr. <b>A419</b> (pce.)			active stone grey <input type="checkbox"/> VO
		<b>815-2038</b>	<b>806-2038</b>	<b>864-2038</b>	<b>885-2038</b>	<b>886-2038</b>	sand-white <input type="checkbox"/> VO
		Price gr. <b>A115</b> (m <sup>2</sup> )	Price gr. <b>A121</b> (m <sup>2</sup> )	Price gr. <b>A419</b> (pce.)	Price gr. <b>A445</b> (pce.)	Price gr. <b>A475</b> (pce.)	sand-white <input type="checkbox"/> VO
		<b>815-2039</b>		<b>864-2039</b>	<b>885-2039</b>	<b>886-2039</b>	medium <input type="checkbox"/> VO
		Price gr. <b>A115</b> (m <sup>2</sup> )		Price gr. <b>A419</b> (pce.)	Price gr. <b>A445</b> (pce.)	Price gr. <b>A475</b> (pce.)	medium <input type="checkbox"/> VO
		<b>815-2040</b>		<b>864-2040</b>	<b>885-2040</b>	<b>886-2040</b>	sand-grey <input type="checkbox"/> VO
		Price gr. <b>A115</b> (m <sup>2</sup> )		Price gr. <b>A419</b> (pce.)	Price gr. <b>A445</b> (pce.)	Price gr. <b>A475</b> (pce.)	sand-grey <input type="checkbox"/> VO
		<b>815-2041</b>		<b>864-2041</b>	<b>885-2041</b>	<b>886-2041</b>	dark sand-grey <input type="checkbox"/> VO
		Price gr. <b>A148</b> (m <sup>2</sup> )		Price gr. <b>A419</b> (pce.)	Price gr. <b>A445</b> (pce.)	Price gr. <b>A475</b> (pce.)	dark sand-grey <input type="checkbox"/> VO
		<b>815-2042</b>	<b>806-2042</b>	<b>864-2042</b>	<b>885-2042</b>	<b>886-2042</b>	medium brown <input type="checkbox"/> VO
		Price gr. <b>A148</b> (m <sup>2</sup> )	Price gr. <b>A121</b> (m <sup>2</sup> )	Price gr. <b>A419</b> (pce.)	Price gr. <b>A445</b> (pce.)	Price gr. <b>A475</b> (pce.)	medium brown <input type="checkbox"/> VO
		<b>815-2043</b>		<b>864-2043</b>	<b>885-2043</b>	<b>886-2043</b>	medium grey <input type="checkbox"/> VO
		Price gr. <b>A148</b> (m <sup>2</sup> )		Price gr. <b>A419</b> (pce.)	Price gr. <b>A445</b> (pce.)	Price gr. <b>A475</b> (pce.)	medium grey <input type="checkbox"/> VO
							medium <input type="checkbox"/> VO
							sand beige <input type="checkbox"/> VO



<sup>1</sup> For details, refer to page 534

<sup>2</sup> For details, refer to page 536

<sup>3</sup> For details, refer to page 536

<sup>4</sup> Color deviations compared to the adjoining covering due to production are no reason for complaint in case of horizontal laying.







## Natural and lively

Besides its natural look, Quarzit is impressive because of a surface vividly nuanced by unusual gloss and mica spots in an authentic stone look. In addition to the aesthetic advantages, there are also practical ones: pleasant haptics is combined with high slip resistance and enormous wear resistance.

Studio photo / Architect: VSBL, Belgrade, Serbia / Photo: Jochen Stüber



basalt-grey



quarz-grey



sand-beige



sepia-brown



white-grey



Floor tile 12.5 x 12.5 cm, 5 x 5 in structured, R11/B



Floor tile 12.5 x 25 cm, 5 x 10 in structured, R11/B



Grid profile tile 12.5 x 25 cm, 5 x 10 in relief, R11/C



Floor tile 15 x 15 cm, 6 x 6 in structured, R11/C



Floor tile 25 x 25 cm, 10 x 10 in structured, R10/A,  
Floor tile 25 x 25 cm, 10 x 10 in structured, R11/B

### Mosaic 5 x 5 cm, 2 x 2 in



Mosaic sheet 30 x 30 cm, 12 x 12 in structured, R11/B



Floor tile 25 x 50 cm, 10 x 20 in, structured, R10/A  
Floor tile 25 x 50 cm, 10 x 20 in, structured, R11/B



Floor tile 30 x 60 cm, 12 x 24 in, structured, R10/A  
Floor tile 30 x 60 cm, 12 x 24 in, structured, R11/B

Mosaic: glass fibre net on reverse side, sheet: 297 x 297 mm



Floor tile 60 x 60 cm, 24 x 24 in, structured, R10/A  
Patio tile 60 x 60 cm, 24 x 24 in, structured, R11/B



Stair tile with bevel 31 x 145 cm, 12 13/64 x 57 in, structured, R10/A



Riser 28 x 145 cm, 11 x 57 in, structured, R10/A



basalt-grey



quarz-grey



sand-beige



sepia-brown



white-grey



Letter tile 25 x 50 cm, 10 x 20 in, structured, R11/B



Skirting, cut 6 x 50 cm, 2 3/8 x 20 in, structured



Skirting, cut 6 x 60 cm, 2 3/8 x 24 in, structured



Cove skirting decorated 10 x 60 cm, 4 x 24 in, structured, R10/A



Grooved tile 50 x 25 cm, 20 x 10 in, grooved, R11/C



Grooved tile 25 x 25 cm, 10 x 10 in grooved, R11/C



Grooved tile 12.5 x 25 cm, 5 x 10 in, grooved, R11/C



Grid profile tile  
25 x 50 cm, 10 x 20 in,  
relief, R11/C

Gutter tile  
(trough depth 5 mm)



Gutter tile  
50 x 25 cm, 20 x 10 in, structured, R11/B

without illustration: Gutter tile with outlet,  
mitred pair, terminal piece

Ceramic channel cover  
50 x 25 cm, 20 x 10 in,  
structured



Ceramic channel cover  
corner solution 30 x 30 cm, 12 x 12 in, structured



For details about Gutter tiles and the Ceramic channel cover, refer to the Pool + Spa programme of delivery.



Floor Tiles - joint 3 mm

5 x 5 cm<sup>1/4</sup>



15 x 15 cm



25 x 25 cm<sup>1</sup>



25 x 25 cm<sup>1</sup>



25 x 50 cm<sup>1</sup>



25 x 50 cm<sup>1</sup>



25 x 50 cm<sup>1/2</sup>



Sheet: 297 x 297 mm

7161H	342030H	332050HK	332050HK	342550HK	342550HK	342580HK	Grid profile tile	Model number
<b>5 x 5 / 2 x 2</b>	<b>15 x 15 / 6 x 6</b>	<b>25 x 25 / 10 x 10</b>	<b>25 x 25 / 10 x 10</b>	<b>25 x 50 / 10 x 20</b>	<b>25 x 50 / 10 x 20</b>	<b>25 x 50 / 10 x 20</b>		Nom. dim. - cm/in
47 x 47 x 8 mm	147 x 147 x 8 mm	247 x 247 x 8 mm	247 x 247 x 8 mm	247 x 497 x 8 mm	247 x 497 x 8 mm	247 x 497 x 8 mm		Work size
structured, matt	structured, matt	structured, matt	structured, matt	structured, matt	structured, matt	relief, matt		Surface
11.111	44.444	16.000	16.000	8.000	8.000	8.000		m <sup>2</sup> - pieces
16.389	17.555	16.960	16.960	17.040	17.040	17.040		m <sup>2</sup> - kg
14	35	14	14	9	9	9		Bundle - pieces
1.260	0.788	0.875	0.875	1.125	1.125	1.125		Bundle - m <sup>2</sup>
20.650	13.825	14.840	14.840	19.170	19.170	19.170		Bundle - kg
37.800	63.001	70.875	70.875	40.500	40.500	40.500		Pallet - m <sup>2</sup>
619.500	1,106.000	1,202.040	1,202.040	690.120	690.120	690.120		Pallet - kg
Ala	Bla	Ala	Ala	Ala	Ala	Ala		Product standard
R11/B	R11/C	R10/A	R11/B	R10/A	R11/B	R11/C		Slip resistance
2	2	2	2	2	2	2		Stress group
<b>8460-7161H</b>	<b>8460-342030H</b>	<b>8450-332050HK</b>	<b>8460-332050HK</b>	<b>8450-342550HK</b>	<b>8460-342550HK</b>	<b>8460-342580HK</b>		basalt grey
Price gr. A289 (m <sup>2</sup> )	Price gr. A157 (m <sup>2</sup> )	Price gr. A148 (m <sup>2</sup> )	Price gr. A157 (m <sup>2</sup> )	Price gr. A157 (m <sup>2</sup> )	Price gr. A166 (m <sup>2</sup> )	Price gr. A181 (m <sup>2</sup> )		
<b>8461-7161H</b>	<b>8461-342030H</b>	<b>8451-332050HK</b>	<b>8461-332050HK</b>	<b>8451-342550HK</b>	<b>8461-342550HK</b>	<b>8461-342580HK</b>		quartz-grey
Price gr. A289 (m <sup>2</sup> )	Price gr. A157 (m <sup>2</sup> )	Price gr. A148 (m <sup>2</sup> )	Price gr. A157 (m <sup>2</sup> )	Price gr. A157 (m <sup>2</sup> )	Price gr. A166 (m <sup>2</sup> )	Price gr. A181 (m <sup>2</sup> )		
<b>8462-7161H</b>	<b>8462-342030H</b>	<b>8452-332050HK</b>	<b>8462-332050HK</b>	<b>8452-342550HK</b>	<b>8462-342550HK</b>	<b>8462-342580HK</b>		sand-beige
Price gr. A289 (m <sup>2</sup> )	Price gr. A157 (m <sup>2</sup> )	Price gr. A148 (m <sup>2</sup> )	Price gr. A157 (m <sup>2</sup> )	Price gr. A157 (m <sup>2</sup> )	Price gr. A166 (m <sup>2</sup> )	Price gr. A181 (m <sup>2</sup> )		
<b>8463-7161H</b>	<b>8463-342030H</b>	<b>8453-332050HK</b>	<b>8463-332050HK</b>	<b>8453-342550HK</b>	<b>8463-342550HK</b>	<b>8463-342580HK</b>		sepia-brown
Price gr. A289 (m <sup>2</sup> )	Price gr. A157 (m <sup>2</sup> )	Price gr. A148 (m <sup>2</sup> )	Price gr. A157 (m <sup>2</sup> )	Price gr. A157 (m <sup>2</sup> )	Price gr. A166 (m <sup>2</sup> )	Price gr. A181 (m <sup>2</sup> )		
<b>8464-7161H</b>	<b>8464-342030H</b>	<b>8454-332050HK</b>	<b>8464-332050HK</b>	<b>8454-342550HK</b>	<b>8464-342550HK</b>	<b>8464-342580HK</b>		white grey
Price gr. A289 (m <sup>2</sup> )	Price gr. A157 (m <sup>2</sup> )	Price gr. A148 (m <sup>2</sup> )	Price gr. A157 (m <sup>2</sup> )	Price gr. A157 (m <sup>2</sup> )	Price gr. A166 (m <sup>2</sup> )	Price gr. A181 (m <sup>2</sup> )		



Floor Tiles - joint 3 mm<sup>1</sup>

30 x 60 cm



30 x 60 cm



60 x 60 cm

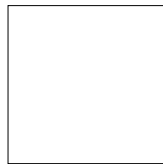

12,5 x 12,5 cm<sup>3</sup>



12,5 x 25 cm



12,5 x 25 cm<sup>2</sup>



B200HK	B200HK	B600HK		32020H	38110H	34090H	Grid profile tile	Model number
<b>30 x 60 / 12 x 24</b>	<b>30 x 60 / 12 x 24</b>	<b>60 x 60 / 24 x 24</b>		<b>12.5 x 12.5 / 5 x 5</b>	<b>12.5 x 25 / 5 x 10</b>	<b>12.5 x 25 / 5 x 10</b>		Nom. dim. - cm/in
297 x 597 x 8 mm	297 x 597 x 8 mm	597 x 597 x 8 mm		119 x 119 x 8 mm	119 x 244 x 8 mm	119 x 244 x 8 mm		Work size
structured, matt	structured, matt	structured, matt		structured, matt	structured, matt	relief, matt		Surface
5.556	5.556	2.778		64.000	32.000	32.000		m <sup>2</sup> - pieces
17.413	17.413	18.001		15.360	15.680	15.360		m <sup>2</sup> - kg
6	6	4		66	33	33		Bundle - pieces
1.080	1.080	1.440		1.031	1.031	1.031		Bundle - m <sup>2</sup>
18.804	18.804	25.920		15.840	16.170	15.840		Bundle - kg
43.197	43.197	43.197		86.625	86.625	86.625		Pallet - m <sup>2</sup>
752.160	752.160	777.600		1,330.560	1,358.280	1,330.560		Pallet - kg
Ala	Ala	Ala		Ala	Ala	Ala		Product standard
R10/A	R11/B	R10/A		R11/B	R11/B	R11/C		Slip resistance
2	2	2		2	2	2		Stress group
<b>8450-B200HK</b>	<b>8460-B200HK</b>	<b>8450-B600HK</b>		<b>8460-32020H</b>	<b>8460-38110H</b>	<b>8460-34090H</b>		basalt grey
Price gr. A124 (m <sup>2</sup> )	Price gr. A142 (m <sup>2</sup> )	Price gr. A136 (m <sup>2</sup> )		Price gr. A157 (m <sup>2</sup> )	Price gr. A127 (m <sup>2</sup> )	Price gr. A148 (m <sup>2</sup> )		
<b>8451-B200HK</b>	<b>8461-B200HK</b>	<b>8451-B600HK</b>		<b>8461-32020H</b>	<b>8461-38110H</b>	<b>8461-34090H</b>		quartz-grey
Price gr. A124 (m <sup>2</sup> )	Price gr. A142 (m <sup>2</sup> )	Price gr. A136 (m <sup>2</sup> )		Price gr. A157 (m <sup>2</sup> )	Price gr. A127 (m <sup>2</sup> )	Price gr. A148 (m <sup>2</sup> )		
<b>8452-B200HK</b>	<b>8462-B200HK</b>	<b>8452-B600HK</b>		<b>8462-32020H</b>	<b>8462-38110H</b>	<b>8462-34090H</b>		sand-beige
Price gr. A124 (m <sup>2</sup> )	Price gr. A142 (m <sup>2</sup> )	Price gr. A136 (m <sup>2</sup> )		Price gr. A157 (m <sup>2</sup> )	Price gr. A127 (m <sup>2</sup> )	Price gr. A148 (m <sup>2</sup> )		
<b>8453-B200HK</b>	<b>8463-B200HK</b>	<b>8453-B600HK</b>		<b>8463-32020H</b>	<b>8463-38110H</b>	<b>8463-34090H</b>		sepia-brown
Price gr. A124 (m <sup>2</sup> )	Price gr. A142 (m <sup>2</sup> )	Price gr. A136 (m <sup>2</sup> )		Price gr. A157 (m <sup>2</sup> )	Price gr. A127 (m <sup>2</sup> )	Price gr. A148 (m <sup>2</sup> )		
<b>8454-B200HK</b>	<b>8464-B200HK</b>	<b>8454-B600HK</b>		<b>8464-32020H</b>	<b>8464-38110H</b>	<b>8464-34090H</b>		white grey
Price gr. A124 (m <sup>2</sup> )	Price gr. A142 (m <sup>2</sup> )	Price gr. A136 (m <sup>2</sup> )		Price gr. A157 (m <sup>2</sup> )	Price gr. A127 (m <sup>2</sup> )	Price gr. A148 (m <sup>2</sup> )		



<sup>1</sup> <sup>2</sup> <sup>3</sup> Supplied as double-tiles; to be broken by customer  
<sup>4</sup> Glass fibre net on reverse side

Stair Tile with Bevel<sup>2/3/5</sup>

31 x 145 cm



Riser<sup>2/3/5</sup>

28 x 145 cm

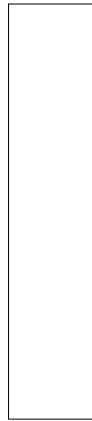

Skirting, cut<sup>1</sup>

6 x 50 cm



6 x 60 cm



Cove Skirting, decorated<sup>1/2/6/10</sup>

10 x 60 cm



Letter Tile  
1/2/4

25 x 50 cm

WT. 1.35m



Model number	B773HK	B774HK	342557HK	B611HK	B612HK		342555HK
Nom. dim. - cm/in	<b>31 x 145</b> / 12 3/8 x 58	<b>28 x 145</b> / 11 3/16 x 58	<b>6 x 50</b> / 2 3/8 x 20	<b>6 x 60</b> / 2 3/8 x 24	<b>10 x 60</b> / 4 x 24		<b>25 x 50</b> / 10 x 20
Work size	307 x 1447 x 10.5 mm	280 x 1447 x 10.5 mm	60 x 497 x 8 mm	60 x 597 x 8 mm	100 x 597/35 x 9 mm		247 x 497 x 8 mm
Surface	structured, matt	structured, matt	structured, matt	structured, matt	structured, matt		structured, matt
m - pieces	0.690	0.690	2.000	1.667	1.667		2
m/pce. - kg	7.480/m	6.716/m	1.098/m	1.100/m	2.000/m		2.130/piece
Bundle - pieces	2	2	30	34	20		
Bundle - m	2.899	2.899	15.000	20.396	11.998		
Bundle - kg	21.682	19.466	16.470	22.440	24.000		
Pallet - m							
Pallet - kg							
Product standard	Ala	Ala	Ala	Ala	Alb		Ala
Slip resistance	R10/A	R10/A			R10/A		R11/B
Stress group	2	2					2
	<b>8450-B773HK</b> Price gr. A560 (pce.)	<b>8450-B774HK</b> Price gr. A528 (pce.)	<b>8450-342557HK</b> Price gr. A434 (pce.)	<b>8450-B611HK</b> Price gr. A434 (pce.)	<b>8450-B612HK<sup>7</sup></b> Price gr. A445 (pce.)		<b>900725-342555HK</b> Price gr. A668 (pce.)
basalt grey	<b>8451-B773HK</b> Price gr. A560 (pce.)	<b>8451-B774HK</b> Price gr. A528 (pce.)	<b>8451-342557HK</b> Price gr. A434 (pce.)	<b>8451-B611HK</b> Price gr. A434 (pce.)	<b>8451-B612HK<sup>8</sup></b> Price gr. A445 (pce.)		<b>900726-342555HK</b> Price gr. A668 (pce.)
quartz-grey	<b>8452-B773HK</b> Price gr. A560 (pce.)	<b>8452-B774HK</b> Price gr. A528 (pce.)	<b>8452-342557HK</b> Price gr. A434 (pce.)	<b>8452-B611HK</b> Price gr. A434 (pce.)	<b>8452-B612HK<sup>8</sup></b> Price gr. A445 (pce.)		<b>900713-342555HK</b> Price gr. A668 (pce.)
sand-beige	<b>8453-B773HK</b> Price gr. A560 (pce.)	<b>8453-B774HK</b> Price gr. A528 (pce.)	<b>8453-342557HK</b> Price gr. A434 (pce.)	<b>8453-B611HK</b> Price gr. A434 (pce.)	<b>8453-B612HK<sup>8</sup></b> Price gr. A445 (pce.)		<b>900714-342555HK</b> Price gr. A668 (pce.)
sepia-brown	<b>8454-B773HK</b> Price gr. A560 (pce.)	<b>8454-B774HK</b> Price gr. A528 (pce.)	<b>8454-342557HK</b> Price gr. A434 (pce.)	<b>8454-B611HK</b> Price gr. A434 (pce.)	<b>8454-B612HK<sup>9</sup></b> Price gr. A445 (pce.)		<b>900719-342555HK</b> Price gr. A668 (pce.)
white grey							

Type height 7 cm

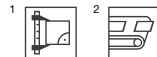

<sup>3</sup> Rectified only on the two short sides. The long side can not be rectified.

<sup>4</sup> Only figures/letters can be realized.

Color combination:

Base color: basalt-grey, quartz-grey, sand-beige, sepia-brown,  
color of letters: active white / neutral 10.

<sup>5</sup> For details, refer to page 538. For more solutions concerning stair design, refer to the series Area Pro.

<sup>6</sup> For detailed drawings of cove skirting, see page 536

<sup>7</sup> Stress group: 2

<sup>8</sup> Stress group: 3

<sup>9</sup> Stress group: 4

<sup>10</sup> Color deviations compared to the adjoining covering due to production are no reason for complaint in case of horizontal laying.

Patio Tiles<sup>1/4</sup>

60 x 60 cm

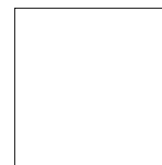

						61061HK	Model number
						<b>60 x 60</b> / 24 x 24	Nom. dim. - <b>cm/in</b>
						597 x 597 x 20 mm	Work size - <b>mm</b>
						structured, matt	Surface
						2.778	<b>m<sup>2</sup></b> - pieces
						43.059	<b>m<sup>2</sup></b> - kg
						1	<b>Bundle</b> - pieces
						0.360	<b>Bundle</b> - m <sup>2</sup>
						15.500	<b>Bundle</b> - kg
						17.279	<b>Pallet</b> - m <sup>2</sup>
						744.000	<b>Pallet</b> - kg
						Alla	Product standard
						R11/B	Slip resistance
						3	Stress group
						<b>8460-61061HK</b>	<b>4</b>
						Price gr. <b>A220</b> (m <sup>2</sup> )	basalt grey <input type="checkbox"/> V4
						<b>8461-61061HK</b>	<b>4</b>
						Price gr. <b>A220</b> (m <sup>2</sup> )	quartz-grey <input type="checkbox"/> V4
						<b>8462-61061HK</b>	<b>4</b>
						Price gr. <b>A220</b> (m <sup>2</sup> )	sand-beige <input type="checkbox"/> V4



Gutter Tiles<sup>2/3/6</sup>  
(trough depth 5 mm)

50 x 25 cm



50 x 25 cm<sup>5</sup>

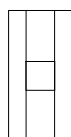

50 x 25 cm

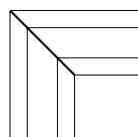

50 x 25 cm<sup>5</sup>

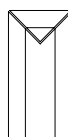

50 x 25 cm

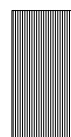

25 x 25 cm



12.5 x 25 cm



<b>Gutter tile</b>	<b>Gutter tile with outlet 110 / 110 mm</b>	<b>Gutter tile, mitred pair</b>	<b>Gutter tile, terminal piece</b>					
53320	53321	53322	53323	53151	53150	53159	Model number	
<b>50 x 25</b> / 20 x 10	<b>50 x 25</b> / 20 x 10			<b>50 x 25</b> / 20 x 10	<b>25 x 25</b> / 10 x 10	<b>12.5 x 25</b> / 5 x 10	Nom. dim. - <b>cm/in</b>	
494 x 244 x 14	494 x 244 x 14	(2x) 490 x 244 x 14	494 x 244 x 14	494 x 244 x 12.5	244 x 244 x 12.5	119 x 244 x 12.5	Work size - <b>mm</b>	
structured, matt	structured, matt	structured, matt	structured, matt	grooved, matt	grooved, matt	grooved, matt	Surface	
2.000				2.000	4.000	8.000	<b>m</b> - pieces	
2.500/piece	2.300/piece	3.800/pair	2.500/piece	3.550/piece	1.775/piece	0.888/piece	<b>Pce./pair</b> - kg	
5 piece	5 piece	2 pair	5 piece	6 piece	9 piece	21 piece	<b>Bundle</b> - pce./pair	
2.500				3.000	2.250	2.625	<b>Bundle</b> - m	
12.500	11.500	7.600	12.500	21.300	15.975	18.648	<b>Bundle</b> - kg	
							<b>Pallet</b> - m	
							<b>Pallet</b> - kg	
							Product standard	
							Slip resistance	
Ala	Ala	Ala	Ala	Ala	Ala	Ala		
R11/B	R11/B	R11/B	R11/B	R11/C	R11/C	R11/C	basalt grey <input type="checkbox"/> V4	
<b>8460-53320H</b>	<b>8460-53321H</b>	<b>8460-53322H</b>	<b>8460-53323H</b>	<b>8460-53151</b>	<b>8460-53150</b>	<b>8460-53159</b>		
Price gr. <b>A519</b> (pce.)	Price gr. <b>A593</b> (pce.)	Price gr. <b>A645</b> (pair)	Price gr. <b>A593</b> (pce.)	Price gr. <b>A560</b> (pce.)	Price gr. <b>A480</b> (pce.)	Price gr. <b>A430</b> (pce.)		
<b>8461-53320H</b>	<b>8461-53321H</b>	<b>8461-53322H</b>	<b>8461-53323H</b>	<b>8461-53151</b>	<b>8461-53150</b>	<b>8461-53159</b>	quartz-grey <input type="checkbox"/> V4	
Price gr. <b>A519</b> (pce.)	Price gr. <b>A593</b> (pce.)	Price gr. <b>A645</b> (pair)	Price gr. <b>A593</b> (pce.)	Price gr. <b>A560</b> (pce.)	Price gr. <b>A480</b> (pce.)	Price gr. <b>A430</b> (pce.)		
<b>8462-53320H</b>	<b>8462-53321H</b>	<b>8462-53322H</b>	<b>8462-53323H</b>	<b>8462-53151</b>	<b>8462-53150</b>	<b>8462-53159</b>	sand-beige <input type="checkbox"/> V4	
Price gr. <b>A519</b> (pce.)	Price gr. <b>A593</b> (pce.)	Price gr. <b>A645</b> (pair)	Price gr. <b>A593</b> (pce.)	Price gr. <b>A560</b> (pce.)	Price gr. <b>A480</b> (pce.)	Price gr. <b>A430</b> (pce.)		
<b>8463-53320H</b>	<b>8463-53321H</b>	<b>8463-53322H</b>	<b>8463-53323H</b>	<b>8463-53151</b>	<b>8463-53150</b>	<b>8463-53159</b>	sepia-brown <input type="checkbox"/> V4	
Price gr. <b>A519</b> (pce.)	Price gr. <b>A593</b> (pce.)	Price gr. <b>A645</b> (pair)	Price gr. <b>A593</b> (pce.)	Price gr. <b>A560</b> (pce.)	Price gr. <b>A480</b> (pce.)	Price gr. <b>A430</b> (pce.)		
<b>8464-53320H</b>	<b>8464-53321H</b>	<b>8464-53322H</b>	<b>8464-53323H</b>	<b>8464-53151</b>	<b>8464-53150</b>	<b>8464-53159</b>	white grey <input type="checkbox"/> V4	
Price gr. <b>A519</b> (pce.)	Price gr. <b>A593</b> (pce.)	Price gr. <b>A645</b> (pair)	Price gr. <b>A593</b> (pce.)	Price gr. <b>A560</b> (pce.)	Price gr. <b>A480</b> (pce.)	Price gr. <b>A430</b> (pce.)		



<sup>3</sup> On request, also available in a length of 497 mm.

<sup>4</sup> High weight only to carry with two persons.

<sup>5</sup> Minimum order quantity: 10 pieces. In case of smaller quantities, the price must be individually calculated.

<sup>6</sup> Short edge rectified

Further details on gutter tiles and grooved tiles in the Pool+Spa delivery programme.

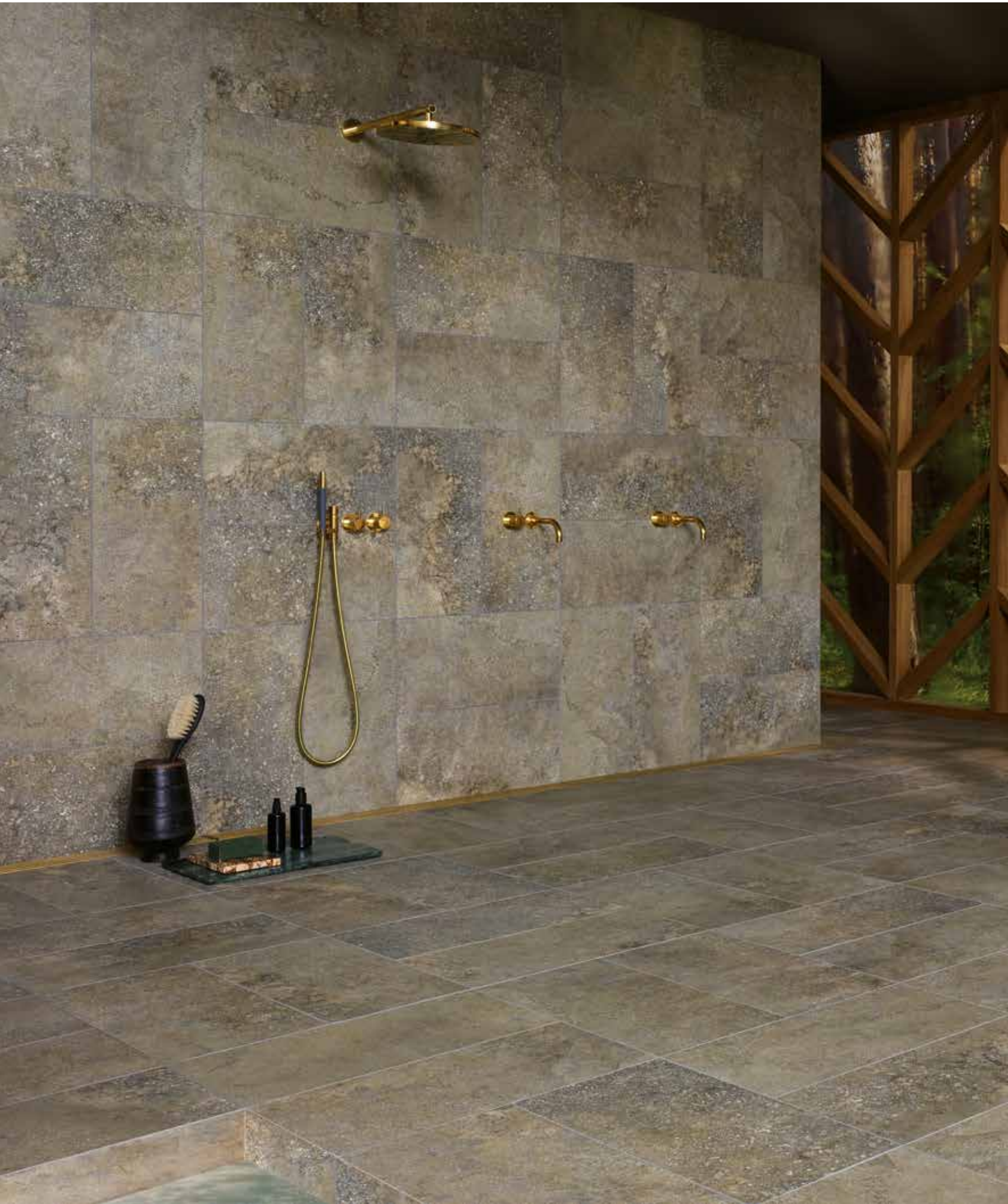



## Elegant and timeless

Structures and colors of various rocks from the Italian coastal region of "Cinque Terre" merge in the Savona floor tile series to create a lively composition of coarsegrained texture and soft layers. A finely dosed granulate application gives the surface a pleasantly stony look and haptics. Mica-like glossy spots underline the natural effect.

Studio photo / Architect: VSBL, Belgrad, Serbia / Photo: Jochen Stüber



lime



beige



brown



grey



anthracite



Floor tile 15 x 15 cm, 6 x 6 in  
structured, R11/C



Floor tile 30 x 60 cm, 12 x 24 in, structured, R10/A  
Floor tile 30 x 60 cm, 12 x 24 in, structured, R11/B



Floor tile 60 x 60 cm, 24 x 24 in, structured, R10/A  
Floor tile 60 x 60 cm, 24 x 24 in, structured, R11/B



Skirting, cut 6 x 60 cm, 2 3/8 x 24 in, structured

### Mosaic 5 x 5 cm, 2 x 2 in



Mosaic sheet 30 x 30 cm, 12 x 12 in  
structured, R11/B

Mosaic: glass fibre net on reverse side,  
sheet: 297 x 297 mm



Floor tile 60 x 120 cm, 24 x 48 in, structured, R10/A

Mosaic<sup>1/2</sup>

Floor Tiles

5 x 5 cm



15 x 15 cm



30 x 60 cm<sup>1</sup>



30 x 60 cm<sup>1</sup>



60 x 60 cm<sup>1</sup>

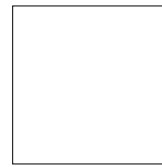

60 x 60 cm<sup>1</sup>

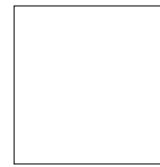

60 x 120 cm<sup>1/3</sup>

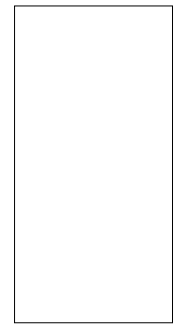

Sheet: 297 x 297 mm

Model number	7161H	342030H	B200HK	B200HK	B600HK	B600HK	B670HK
Nom. dim. - cm/in	5 x 5 / 2 x 2	15 x 15 / 6 x 6	30 x 60 / 12 x 24	30 x 60 / 12 x 24	60 x 60 / 24 x 24	60 x 60 / 24 x 24	60 x 120 / 24 x 48
Work size	47 x 47 x 8 mm	147 x 147 x 8 mm	297 x 597 x 8 mm	297 x 597 x 8 mm	597 x 597 x 8 mm	597 x 597 x 8 mm	597 x 1197 x 8 mm
Surface	structured, matt	structured, matt	structured, matt	structured, matt	structured, matt	structured, matt	structured, matt
m <sup>2</sup> - pieces	11.111	44.444	5.556	5.556	2.778	2.778	1.388
m <sup>2</sup> - kg	16.389	17.555	17.413	17.413	18.001	18.001	17.489
Bundle - pieces	14	35	6	6	4	4	2
Bundle - m <sup>2</sup>	1.260	0.788	1.080	1.080	1.440	1.440	1.441
Bundle - kg	20.650	13.825	18.804	18.804	25.920	25.920	25.200
Pallet - m <sup>2</sup>	37.800	63.001	43.197	43.197	43.197	43.197	36.023
Pallet - kg	619.500	1,106.000	752.160	752.160	777.600	777.600	630.000
Product standard	Ala	Bla	Ala	Ala	Ala	Ala	Ala
Slip resistance	R11/B	R11/C	R10/A	R11/B	R10/A	R11/B	R10/A
Stress group	2	2	2	2	2	2	2
lime	<b>8810-7161H</b> Price gr. <b>A289</b> (m <sup>2</sup> )	<b>8810-342030H</b> Price gr. <b>A157</b> (m <sup>2</sup> )	<b>8800-B200HK</b> Price gr. <b>A124</b> (m <sup>2</sup> )	<b>8810-B200HK</b> Price gr. <b>A142</b> (m <sup>2</sup> )	<b>8800-B600HK</b> Price gr. <b>A136</b> (m <sup>2</sup> )	<b>8810-B600HK</b> Price gr. <b>A151</b> (m <sup>2</sup> )	<b>8800-B670HK</b> Price gr. <b>A166</b> (m <sup>2</sup> )
beige	<b>8811-7161H</b> Price gr. <b>A289</b> (m <sup>2</sup> )	<b>8811-342030H</b> Price gr. <b>A157</b> (m <sup>2</sup> )	<b>8801-B200HK</b> Price gr. <b>A124</b> (m <sup>2</sup> )	<b>8811-B200HK</b> Price gr. <b>A142</b> (m <sup>2</sup> )	<b>8801-B600HK</b> Price gr. <b>A136</b> (m <sup>2</sup> )	<b>8811-B600HK</b> Price gr. <b>A151</b> (m <sup>2</sup> )	<b>8801-B670HK</b> Price gr. <b>A166</b> (m <sup>2</sup> )
brown	<b>8812-7161H</b> Price gr. <b>A289</b> (m <sup>2</sup> )	<b>8812-342030H</b> Price gr. <b>A157</b> (m <sup>2</sup> )	<b>8802-B200HK</b> Price gr. <b>A124</b> (m <sup>2</sup> )	<b>8812-B200HK</b> Price gr. <b>A142</b> (m <sup>2</sup> )	<b>8802-B600HK</b> Price gr. <b>A136</b> (m <sup>2</sup> )	<b>8812-B600HK</b> Price gr. <b>A151</b> (m <sup>2</sup> )	<b>8802-B670HK</b> Price gr. <b>A166</b> (m <sup>2</sup> )
grey	<b>8813-7161H</b> Price gr. <b>A289</b> (m <sup>2</sup> )	<b>8813-342030H</b> Price gr. <b>A157</b> (m <sup>2</sup> )	<b>8803-B200HK</b> Price gr. <b>A124</b> (m <sup>2</sup> )	<b>8813-B200HK</b> Price gr. <b>A142</b> (m <sup>2</sup> )	<b>8803-B600HK</b> Price gr. <b>A136</b> (m <sup>2</sup> )	<b>8813-B600HK</b> Price gr. <b>A151</b> (m <sup>2</sup> )	<b>8803-B670HK</b> Price gr. <b>A166</b> (m <sup>2</sup> )
anthracite	<b>8814-7161H</b> Price gr. <b>A289</b> (m <sup>2</sup> )	<b>8814-342030H</b> Price gr. <b>A157</b> (m <sup>2</sup> )	<b>8804-B200HK</b> Price gr. <b>A124</b> (m <sup>2</sup> )	<b>8814-B200HK</b> Price gr. <b>A142</b> (m <sup>2</sup> )	<b>8804-B600HK</b> Price gr. <b>A136</b> (m <sup>2</sup> )	<b>8814-B600HK</b> Price gr. <b>A151</b> (m <sup>2</sup> )	<b>8804-B670HK</b> Price gr. <b>A166</b> (m <sup>2</sup> )



Skirting, cut<sup>1</sup>

6 x 60 cm



Model number	B611HK						
Nom. dim. - cm/in	6 x 60 / 2 3/8 x 24						
Work size	60 x 597 x 8 mm						
Surface	structured, matt						
m - pieces	1.667						
m - kg	1.100						
Bundle - pieces	34						
Bundle - m	20.396						
Bundle - kg	22.440						
Pallet - m							
Pallet - kg							
Product standard	Ala						
lime	<b>8800-B611HK</b> Price gr. <b>A434</b> (pce.)						
beige	<b>8801-B611HK</b> Price gr. <b>A434</b> (pce.)						
brown	<b>8802-B611HK</b> Price gr. <b>A434</b> (pce.)						
grey	<b>8803-B611HK</b> Price gr. <b>A434</b> (pce.)						
anthracite	<b>8804-B611HK</b> Price gr. <b>A434</b> (pce.)						



<sup>1</sup> Glass fibre net on reverse side  
<sup>3</sup> High weight only to carry with two persons.



Studio photo / Architect: VSBL, Belgrade, Serbia / Photo: Jochen Stüber







## Zeitgeist meets timeless

The Senja Pure ceramic tile series gives bathrooms and private wellness areas a cosy touch and a warm, lively impression. Its natural colors and finely structured surfaces are trendy and at the same time timelessly beautiful. The result: rooms harmoniously matched to one another in clear vintage style, in pleasantly restrained Nordic Design or in Shabby-Chic-Style. The successful collection was extended to include the strong color Shabby-Chic-Brown and large-size natural-white wall tiles – thus offering even more scope for design.

Rendering

Mosaic 2.5 x 2.5 cm, 1 x 1 in



Mosaic sheet 30 x 30 cm, 12 x 12 in maple, structured,  
Mosaic sheet 30 x 30 cm, 12 x 12 in maple, structured, R10/B

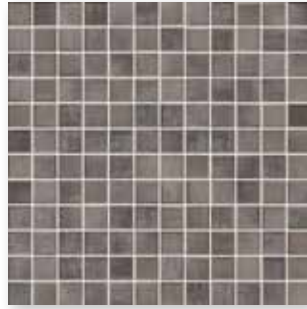

Mosaic sheet 30 x 30 cm, 12 x 12 in shabby chic brown, structured,  
Mosaic sheet 30 x 30 cm, 12 x 12 in shabby chic brown, structured, R10/B



Mosaic sheet 30 x 30 cm, 12 x 12 in wenge-metallic, structured

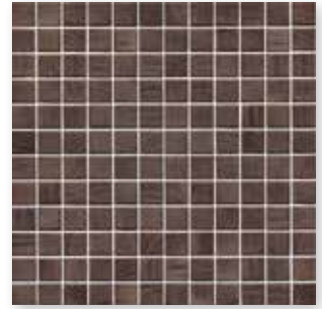

Mosaic sheet 30 x 30 cm, 12 x 12 in wenge, structured,  
Mosaic sheet 30 x 30 cm, 12 x 12 in wenge, structured, R10/B

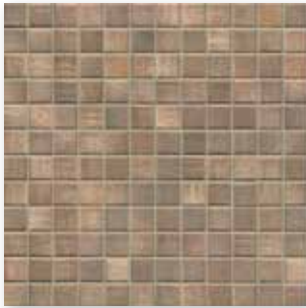

Mosaic sheet 30 x 30 cm, 12 x 12 in oak, structured,  
Mosaic sheet 30 x 30 cm, 12 x 12 in oak, structured, R10/B



Mosaic sheet 30 x 30 cm, 12 x 12 in shabby chic, structured,  
Mosaic sheet 30 x 30 cm, 12 x 12 in shabby chic, structured, R10/B



Mosaic sheet 30 x 30 cm, 12 x 12 in wood-mix, structured



Mosaic sheet 30 x 30 cm, 12 x 12 in wood-mix metallic, structured



Mosaics glued thermoplastically on back can be used not only in dry zones but also without any problems in underwater areas (e.g. swimming pools/whirlpools) as well as in permanently wet areas.

Mosaic 5 x 5 cm, 2 x 2 in



Mosaic sheet 30 x 30 cm, 12 x 12 in maple, structured, R10/B



Mosaic sheet 30 x 30 cm, 12 x 12 in shabby chic brown, structured, R10/B



Mosaic sheet 30 x 30 cm, 12 x 12 in wenge, structured, R10/B



Mosaic sheet 30 x 30 cm, 12 x 12 in oak, structured, R10/B



Mosaic sheet 30 x 30 cm, 12 x 12 in shabby chic, structured, R10/B



Mosaics glued thermoplastically on back can be used not only in dry zones but also without any problems in underwater areas (e.g. swimming pools/whirlpools) as well as in permanently wet areas.

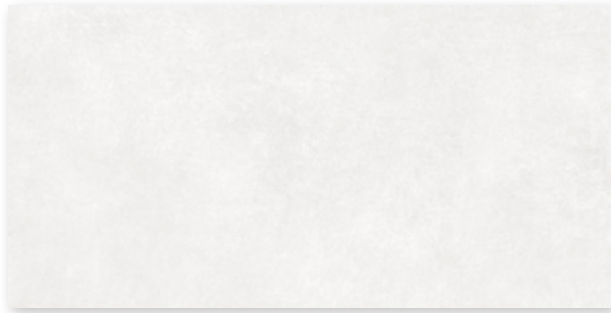

Wall tile 30 x 60 cm, 12 x 24 in, natural-white, smooth



Wall tile 30 x 90 cm, 12 x 36 in, natural-white, smooth

Wall Tiles<sup>4</sup>

Mosaic<sup>1</sup>

30 x 60 cm

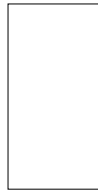

30 x 90 cm<sup>2</sup>

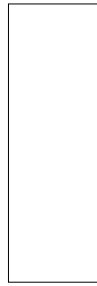

2,5 x 2,5 cm



2,5 x 2,5 cm



5 x 5 cm



		30 x 60 / 12 x 24	30 x 90 / 12 x 36	2.5 x 2.5 / 1 x 1	2.5 x 2.5 / 1 x 1	5 x 5 / 2 x 2	
		297 x 597 x 6 mm	297 x 897 x 6 mm	23 x 23 x 6.5 mm	23 x 23 x 6.5 mm	47 x 47 x 6.5 mm	Nom. dim. - cm/in
		smooth, silky-matt	smooth, silky-matt	structured, matt	structured, matt	structured, matt	Work size
		5.556	3.704	11 sheets	11 sheets	11 sheets	Surface
		10.279	10.400	12.100	12.100	12.331	m <sup>2</sup> - piece
		13	8	11 sheets	11 sheets	11 sheets	m <sup>2</sup> - kg
		2.340	2.160	1.000	1.000	1.000	Bundle - piece
		24.050	22.464	12.100	12.100	12.331	Bundle - m <sup>2</sup>
		112.311	51.836	48.000	48.000	64.000	Bundle - kg
		1,154.400	539.136	580.800	580.800	789.184	Pallet - m <sup>2</sup>
		BIII	BIII	Blb	Blb	Blb	Pallet - kg
				R10/B	R10/B	R10/B	Product standard
				1	1	1	Slip resistance
		<b>203331H</b>	<b>323332H</b>				Stress group
		Price gr. <b>W90</b> (m <sup>2</sup> )	Price gr. <b>W111</b> (m <sup>2</sup> )				natural white <input type="checkbox"/> V1
				<b>3221H</b>	<b>3201H</b>	<b>3251H</b>	4
				Price gr. <b>W288</b> (m <sup>2</sup> )	Price gr. <b>W303</b> (m <sup>2</sup> )	Price gr. <b>W240</b> (m <sup>2</sup> )	maple <input type="checkbox"/> V2
				<b>3222H</b>	<b>3206H</b>	<b>3252H</b>	3
				Price gr. <b>W288</b> (m <sup>2</sup> )	Price gr. <b>W303</b> (m <sup>2</sup> )	Price gr. <b>W240</b> (m <sup>2</sup> )	shabby chic brown <input type="checkbox"/> V3
				<b>3227<sup>3/5</sup></b>			2
				Price gr. <b>W323</b> (m <sup>2</sup> )			wenge-metallic <input type="checkbox"/> V2
				<b>3228H</b>	<b>3202H</b>	<b>3258H</b>	2
				Price gr. <b>W288</b> (m <sup>2</sup> )	Price gr. <b>W303</b> (m <sup>2</sup> )	Price gr. <b>W240</b> (m <sup>2</sup> )	wenge <input type="checkbox"/> V2
				<b>3303H</b>	<b>3203H</b>	<b>3353H</b>	4
				Price gr. <b>W288</b> (m <sup>2</sup> )	Price gr. <b>W303</b> (m <sup>2</sup> )	Price gr. <b>W240</b> (m <sup>2</sup> )	oak <input type="checkbox"/> V2
				<b>3304H</b>	<b>3314H</b>	<b>3354H</b>	4
				Price gr. <b>W288</b> (m <sup>2</sup> )	Price gr. <b>W303</b> (m <sup>2</sup> )	Price gr. <b>W240</b> (m <sup>2</sup> )	shabby chic <input type="checkbox"/> V3
				<b>3305H</b>			4
				Price gr. <b>W303</b> (m <sup>2</sup> )			wood-mix <input type="checkbox"/> V4
				<b>3306<sup>3/5</sup></b>			1
				Price gr. <b>W323</b> (m <sup>2</sup> )			wood-mix metallic <input type="checkbox"/> V4



<sup>3</sup> Not or only to a limited extent resistant to acids and alkalis.

<sup>4</sup> Not frost-resistant

<sup>5</sup> without Hytect coating







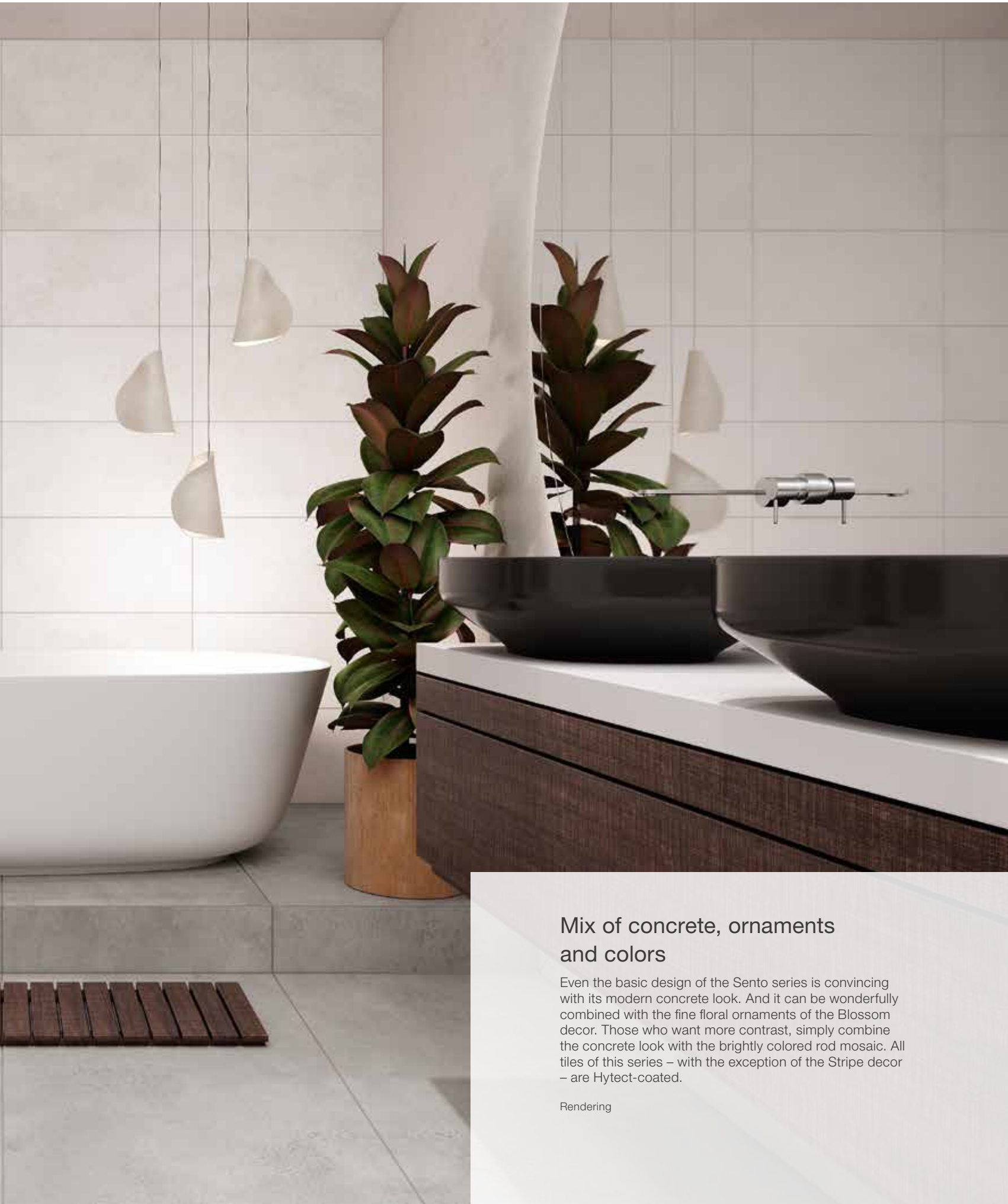

## Mix of concrete, ornaments and colors

Even the basic design of the Sento series is convincing with its modern concrete look. And it can be wonderfully combined with the fine floral ornaments of the Blossom decor. Those who want more contrast, simply combine the concrete look with the brightly colored rod mosaic. All tiles of this series – with the exception of the Stripe decor – are Hytect-coated.

Rendering

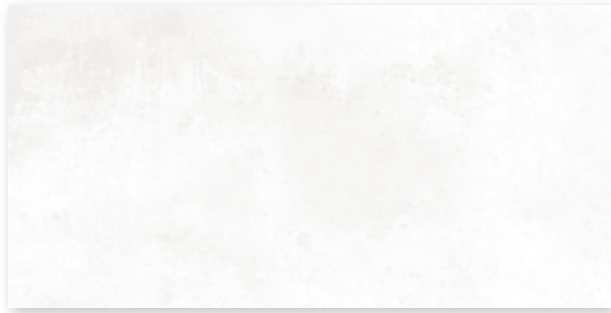

Wall tile 30 x 60 cm, 12 x 24 in, pale white, structured



Wall tile 35 x 100 cm, 14 x 40 in, pale white, structured

## Decoration elements



Decorative tile Blossom 30 x 60 cm, 12 x 24 in, beige grey, structured

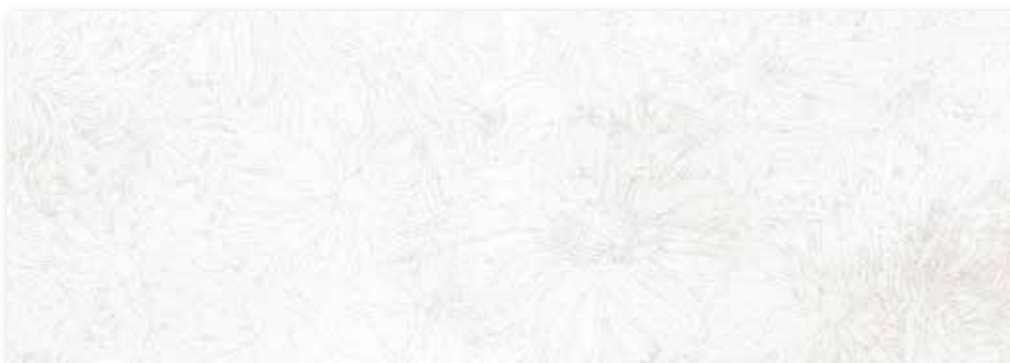

Decorative tile Blossom 35 x 100 cm, 14 x 40 in, beige grey, structured



## Decoration elements



Cut decoration Color Stripe 30 x 30 cm,  
12 x 12 in, sky aqua, structured

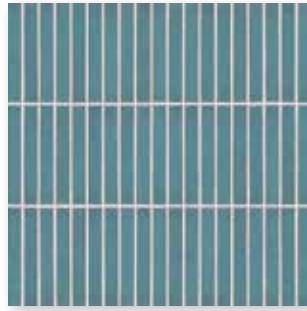

Cut decoration Color Stripe 30 x 30 cm,  
12 x 12 in, pacific blue, structured



Cut decoration Color Stripe 30 x 30 cm,  
12 x 12 in, lava black, structured

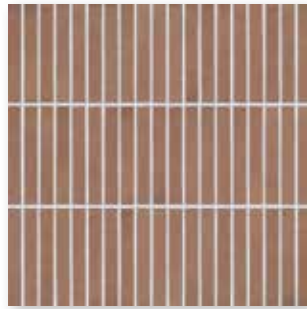

Cut decoration Color Stripe 30 x 30 cm,  
12 x 12 in, earth red, structured

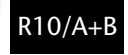
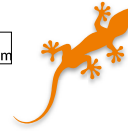

off white



concrete grey



pale mud



dark anthracite



Floor tile 30 x 60 cm, 12 x 24 in, structured, R10/A+B



Floor tile 60 x 60 cm, 24 x 24 in, structured, R10/A+B



Floor tile 60 x 120 cm, 24 x 48 in, structured, R10/A+B



Skirting, cut 7 x 60 cm, 2 13/16 x 24 in, structured

## Decoration elements



Floor decor Blossom 60 x 60 cm, 24 x 24 in, structured, R10/A+B

## Mosaic 5 x 5 cm, 2 x 2 in



Mosaic sheet 30 x 30 cm, 12 x 12 in, off white, structured, R10/A+B



Mosaic sheet 30 x 30 cm, 12 x 12 in, concrete grey, structured, R10/A+B



Mosaic sheet 30 x 30 cm, 12 x 12 in, pale mud, structured, R10/A+B

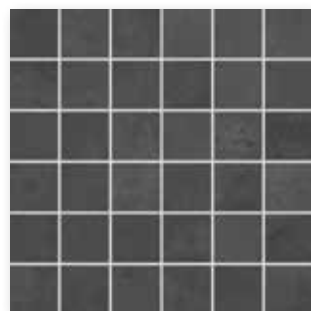

Mosaic sheet 30 x 30 cm, 12 x 12 in, dark anthracite, structured, R10/A+B

Mosaic: Glass fibre net on reverse side,  
Sheet: 297 x 297 mm

Wall Tiles

Decoration Elements<sup>6</sup>

30 x 60 cm



35 x 100 cm<sup>1</sup>

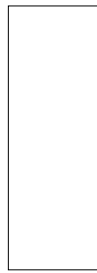

30 x 60 cm

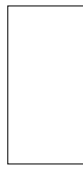

35 x 100 cm<sup>1</sup>



30 x 30 cm<sup>2/3/4/5</sup>



	<b>30 x 60</b> / 12 x 24	<b>35 x 100 cm</b> / 14 x 40	<b>30 x 60</b> / 12 x 24	<b>35 x 100 cm</b> / 14 x 40	<b>30 x 30</b> / 12 x 12		
Nom. dim. - cm/in	297 x 597 x 6 mm	347 x 997 x 6 mm	297 x 597 x 6 mm	347 x 997 x 6 mm	297 x 297 x 6.5 mm		
Work size	297 x 597 x 6 mm	347 x 997 x 6 mm	297 x 597 x 6 mm	347 x 997 x 6 mm	297 x 297 x 6.5 mm		
Surface	structured, stone-matt	structured, stone-matt	structured, stone-matt	structured, stone-matt	strukturiert, semi-matt		
m <sup>2</sup> /m - pieces	5.556/m <sup>2</sup>	2.857/m <sup>2</sup>	5.556/m <sup>2</sup>	2.857/m <sup>2</sup>	3.333/m		
m <sup>2</sup> /m - kg	10.279/m <sup>2</sup>	10.108/m <sup>2</sup>	10.279/m <sup>2</sup>	10.108/m <sup>2</sup>	3.326/m		
Bundle - pieces	13	5	13	5	5		
Bundle - m <sup>2</sup> /m	2.340 m <sup>2</sup>	1.750 m <sup>2</sup>	2.340 m <sup>2</sup>	1.750 m <sup>2</sup>	1.500 m		
Bundle - kg	24.050	17.690	24.050	17.690	4.990		
Pallet - m <sup>2</sup>	112.311	70.004	112.311	70.004			
Pallet - kg	1,154.400	707.600	1,154.400	707.600			
Product standard	BIII	BIII	BIII	BIII	Bla		
	<b>203412H</b>	<b>363414H</b>					
pale white	Price gr. <b>C77</b> (m <sup>2</sup> )	Price gr. <b>C143</b> (m <sup>2</sup> )					
			<b>203413H</b>	<b>363415H</b>			
beige grey			Price gr. <b>C89</b> (m <sup>2</sup> )	Price gr. <b>C149</b> (m <sup>2</sup> )			
					<b>203408</b>		
sky aqua					Price gr. <b>C558</b> (pce.)		
					<b>203409</b>		
pacific blue					Price gr. <b>C558</b> (pce.)		
					<b>203410</b>		
lava black					Price gr. <b>C558</b> (pce.)		
					<b>203411</b>		
earth red					Price gr. <b>C558</b> (pce.)		



<sup>1</sup> Glass fibre net on reverse side  
<sup>2</sup> Only suitable for laying on the wall.  
<sup>3</sup> without Hytect coating  
<sup>4</sup> without Hytect coating  
<sup>5</sup> without Hytect coating  
<sup>6</sup> Decoration elements only available in full boxes.

Mosaic<sup>1/2</sup>

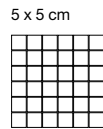

Floor Tiles<sup>1</sup>

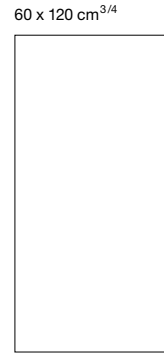
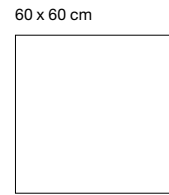

Decoration Elements<sup>1/5</sup>

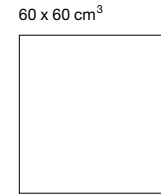

Skirting, cut<sup>1</sup>

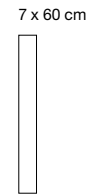

Sheet: 297 x 297 mm

Floor decor  
Blossom



5 x 5 / 2 x 2	30 x 60 / 12 x 24	60 x 60 / 24 x 24	60 x 120 / 24 x 48	60 x 60 / 24 x 24	7 x 60 / 2 13/16 x 24	Nom. dim. - cm/in
47 x 47 x 6 mm	297 x 597 x 6 mm	597 x 597 x 6 mm	597 x 1197 x 6 mm	597 x 597 x 6 mm	70 x 597 x 6 mm	Work size
structured, matt	structured, matt	structured, matt	structured, matt	structured, matt	structured, matt	Surface
11.111 sheets/m <sup>2</sup>	5.556/m <sup>2</sup>	2.778/m <sup>2</sup>	1.388/m <sup>2</sup>	2.778/m <sup>2</sup>	1.667/m	m <sup>2</sup> /m - pieces
11.488 sheets/m <sup>2</sup>	13.273/m <sup>2</sup>	13.581/m <sup>2</sup>	14.088/m <sup>2</sup>	13.581/m <sup>2</sup>	0.938/m	m <sup>2</sup> /m - kg
11	10	5	3	5	38	Bundle - pieces
0.990 m <sup>2</sup>	1.800 m <sup>2</sup>	1.800 m <sup>2</sup>	2.161 m <sup>2</sup>	1.800 m <sup>2</sup>	22.795 m	Bundle - m <sup>2</sup> /m
11.374	23.890	24.445	30.450	24.445	21.394	Bundle - kg
35.640	71.994	64.795	75.648	64.795		Pallet - m <sup>2</sup>
409.464	955.600	880.020	1,065.750	880.020		Pallet - kg
Bla	Bla	Bla	Bla	Bla	Bla	Product standard
R10/A+B	R10/A+B	R10/A+B	R10/A+B	R10/A+B		Slip resistance
1	1	1	1	1		Stress group
<b>431601H</b> Price gr. <b>C308</b> (m <sup>2</sup> )	<b>431605H</b> Price gr. <b>C98</b> (m <sup>2</sup> )	<b>431609H</b> Price gr. <b>C107</b> (m <sup>2</sup> )	<b>431613H</b> Price gr. <b>C137</b> (m <sup>2</sup> )	<b>431617H</b> Price gr. <b>C116</b> (m <sup>2</sup> )	<b>431621H</b> Price gr. <b>C440</b> (pce.)	off white <input type="checkbox"/> V2
						off white <input type="checkbox"/> V3
<b>431602H</b> Price gr. <b>C308</b> (m <sup>2</sup> )	<b>431606H</b> Price gr. <b>C98</b> (m <sup>2</sup> )	<b>431610H</b> Price gr. <b>C107</b> (m <sup>2</sup> )	<b>431614H</b> Price gr. <b>C137</b> (m <sup>2</sup> )	<b>431618H</b> Price gr. <b>C116</b> (m <sup>2</sup> )	<b>431622H</b> Price gr. <b>C440</b> (pce.)	concrete grey <input type="checkbox"/> V2
						concrete grey <input type="checkbox"/> V3
<b>431603H</b> Price gr. <b>C308</b> (m <sup>2</sup> )	<b>431607H</b> Price gr. <b>C98</b> (m <sup>2</sup> )	<b>431611H</b> Price gr. <b>C107</b> (m <sup>2</sup> )	<b>431615H</b> Price gr. <b>C137</b> (m <sup>2</sup> )	<b>431619H</b> Price gr. <b>C116</b> (m <sup>2</sup> )	<b>431623H</b> Price gr. <b>C440</b> (pce.)	pale mud <input type="checkbox"/> V2
						pale mud <input type="checkbox"/> V3
<b>431604H</b> Price gr. <b>C308</b> (m <sup>2</sup> )	<b>431608H</b> Price gr. <b>C98</b> (m <sup>2</sup> )	<b>431612H</b> Price gr. <b>C107</b> (m <sup>2</sup> )	<b>431616H</b> Price gr. <b>C137</b> (m <sup>2</sup> )	<b>431620H</b> Price gr. <b>C116</b> (m <sup>2</sup> )	<b>431624H</b> Price gr. <b>C440</b> (pce.)	dark anthracite <input type="checkbox"/> V2
						dark anthracite <input type="checkbox"/> V3



<sup>1</sup> Glass fibre net on reverse side

<sup>2</sup> Please note: special pallet. No return, no exchange.

<sup>3</sup> High weight only to carry with two persons.

<sup>4</sup> Decoration elements only available in full boxes.









## Original and elegant

The porcelain stoneware Sierra series adds originality and naturalness to living areas thanks to its colors and surface look. The color light-beige authentically reflects the characteristics of sandstone and its subtle color layers with typical color variations. In the anthracite variant, block mosaics in various sizes and cutting angles emphasize the masonry character even further. Matching floor tiles in the sizes 5 x 5 cm and 30 x 60 cm are available in the four colors of the series (light-beige, anthracite and light-grey). The floor and stair tiles (30 x 60 cm) are Protecta-upgraded and feature slip resistance R10/A.

Studio photo



R10/A



anthracite



light-grey



light-beige



Floor tile 30 x 60 cm, 12 x 24 in, structured, R10/A



Stair tile 30 x 60 cm, 12 x 24 in (with grooves), structured, R10/A

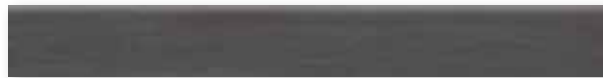

Skirting, rounded 7 x 60 cm, 2 13/16 x 24 in, structured



### Mosaic 5 x 5 cm, 2 x 2 in

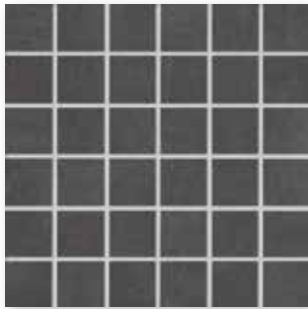

Mosaic sheet 30 x 30 cm, 12 x 12 in anthracite, structured, R10/B



Mosaic sheet 30 x 30 cm, 12 x 12 in light-grey, structured, R10/B

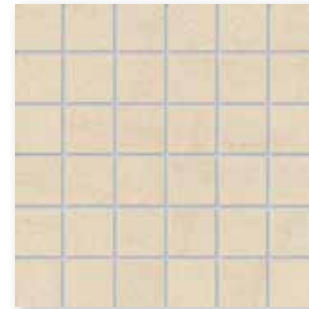

Mosaic sheet 30 x 30 cm, 12 x 12 in light-beige, structured, R10/B

Mosaic: Glass fibre net on reverse side, Sheet: 297 x 297 mm.

### Oblong mosaic



Oblong mosaic 30 x 30 cm, 12 x 12 in anthracite, structured, R10/A



Oblong mosaic 30 x 30 cm, 12 x 12 in light-grey, structured, R10/A



Oblong mosaic 30 x 30 cm, 12 x 12 in light-beige, structured, R10/A

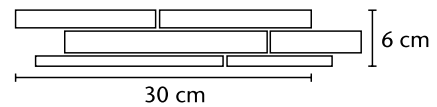

Proposal for borders design: five borders can be taken from one mosaic sheet according to the enclosed sketch = 1.5 lin. m.

Oblong mosaic: Glass fibre net on reverse side, Sheet: 298 x 298 mm.

Mosaic<sup>1/3</sup>

5 x 5 cm

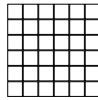

Oblong Mosaic<sup>3</sup>

30 x 30 cm

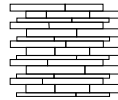

Floor Tiles<sup>1</sup>

30 x 60 cm



Stair Tiles<sup>1/2</sup>

30 x 60 cm

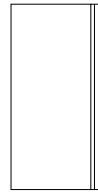

Skirting, rounded<sup>1</sup>

7 x 60 cm<sup>1</sup>



protected

Sheet: 297 x 297 mm

Sheet: 298 x 298 mm

Nom. dim. - cm/in	<b>5 x 5 / 2 x 2</b>	<b>30 x 30 / 12 x 12</b>	<b>30 x 60 / 12 x 24</b>	<b>30 x 60 / 12 x 24</b>	<b>7 x 60 / 2 13/16 x 24</b>		
Work size	47 x 47 x 9 mm	298 x 298 x 9 mm	297 x 597 x 9 mm	297 x 597 x 9 mm	70 x 597 x 9 mm		
Surface	structured, matt	structured, matt	structured, matt	structured, matt	structured, matt		
m <sup>2</sup> /m - pieces	11.111 sheets/m <sup>2</sup>	11.111 sheets/m <sup>2</sup>	5.556/m <sup>2</sup>	1.667/m	1.667/m		
m <sup>2</sup> /m - kg	19.833/m <sup>2</sup>	20.755/m <sup>2</sup>	19.907/m <sup>2</sup>	5.973/m	1.357/m		
Bundle - pieces	12 sheets	12 sheets	7	7	22		
Bundle - m <sup>2</sup> /m	1.080 m <sup>2</sup>	1.080 m <sup>2</sup>	1.260 m <sup>2</sup>	4.199 m	13.197 m		
Bundle - kg	21.420	22.416	25.081	25.081	17.908		
Pallet - m <sup>2</sup>	32.400	32.400	50.396				
Pallet - kg	642.600	672.480	1,003.240				
Product standard	Bla	Bla	Bla	Bla	Bla		
Slip resistance	R10/B	R10/A	R10/A	R10/A			
Stress group	2	2	2	2			
anthracite	<b>431380</b> Price gr. <b>C314</b> (m <sup>2</sup> )	<b>431386</b> Price gr. <b>C377</b> (m <sup>2</sup> )	<b>431383</b> Price gr. <b>C98</b> (m <sup>2</sup> )	<b>431389</b> Price gr. <b>C474</b> (pce.)	<b>431392</b> Price gr. <b>C440</b> (pce.)		
light-grey	<b>431381</b> Price gr. <b>C314</b> (m <sup>2</sup> )	<b>431387</b> Price gr. <b>C377</b> (m <sup>2</sup> )	<b>431384</b> Price gr. <b>C98</b> (m <sup>2</sup> )	<b>431390</b> Price gr. <b>C474</b> (pce.)	<b>431393</b> Price gr. <b>C440</b> (pce.)		
light-beige	<b>431382</b> Price gr. <b>C314</b> (m <sup>2</sup> )	<b>431388</b> Price gr. <b>C377</b> (m <sup>2</sup> )	<b>431385</b> Price gr. <b>C98</b> (m <sup>2</sup> )	<b>431391</b> Price gr. <b>C474</b> (St.)	<b>431394</b> Price gr. <b>C440</b> (pce.)		

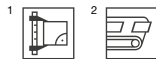

<sup>3</sup> Glass fibre net on reverse side

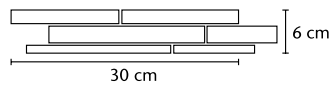

Proposal for borders design: five borders can be taken from one mosaic sheet according to the enclosed sketch = 1.5 lin. m.

Studio photo





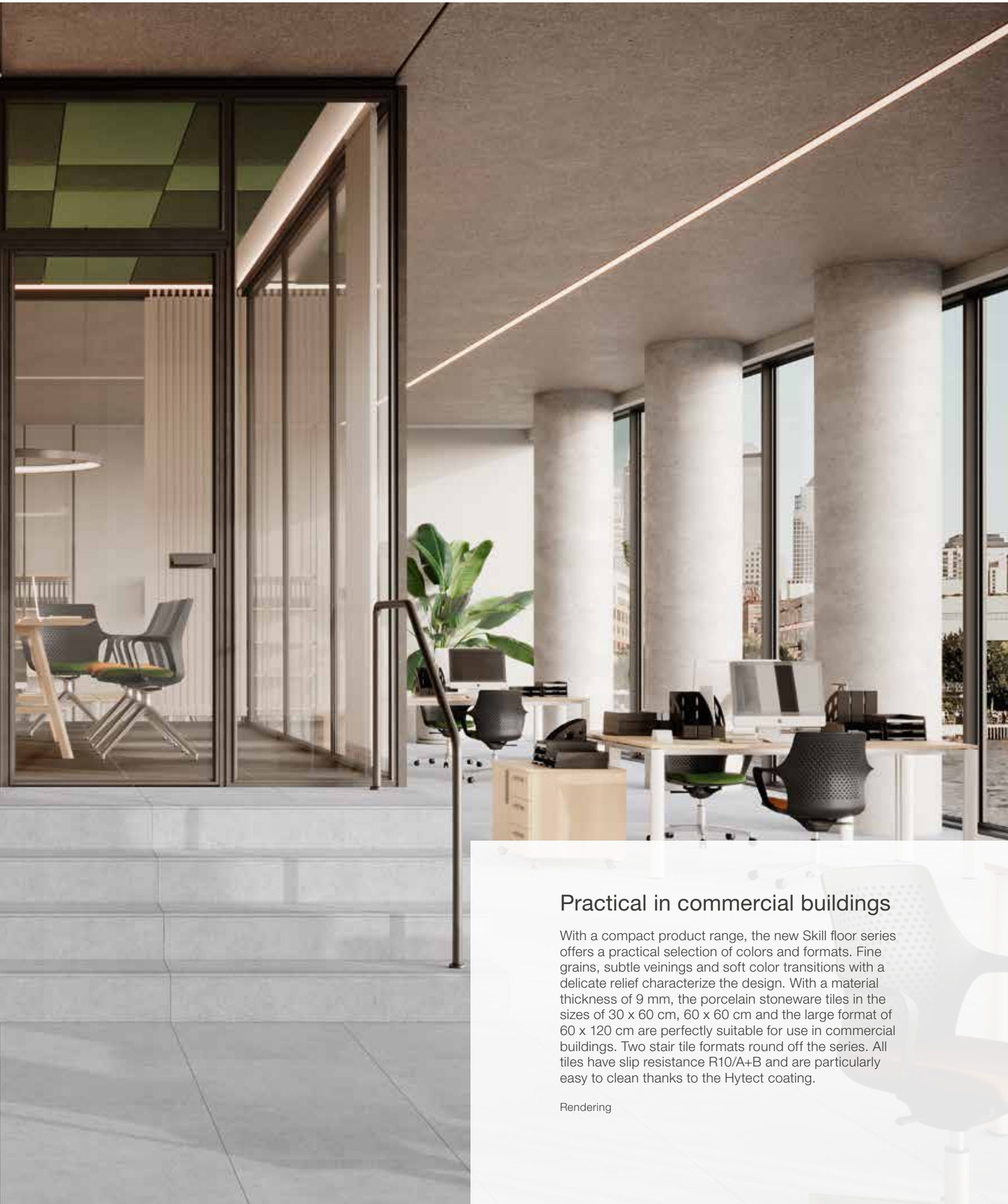

## Practical in commercial buildings

With a compact product range, the new Skill floor series offers a practical selection of colors and formats. Fine grains, subtle veinings and soft color transitions with a delicate relief characterize the design. With a material thickness of 9 mm, the porcelain stoneware tiles in the sizes of 30 x 60 cm, 60 x 60 cm and the large format of 60 x 120 cm are perfectly suitable for use in commercial buildings. Two stair tile formats round off the series. All tiles have slip resistance R10/A+B and are particularly easy to clean thanks to the Hytect coating.

Rendering



R10/A+B



dark taupe



light sand



warm grey



dark anthracite



Floor tile 30 x 60 cm, 12 x 24 in, structured, R10/A+B



Floor tile 60 x 60 cm, 24 x 24 in, structured, R10/A+B



Floor tile 60 x 120 cm, 24 x 48 in, structured, R10/A+B





Stair tile 30 x 60 cm, 12 x 24 in (with grooves), structured, R10/A+B



Stair tile 30 x 120 cm, 12 x 48 in (with grooves), structured, R10/A+B



Skirting, cut 7 x 60 cm, 2 13/16 x 24 in, structured

Floor Tiles<sup>1</sup>

Stair Tiles<sup>1/2</sup>

Skirting, cut<sup>1</sup>

30 x 60 cm



60 x 60 cm

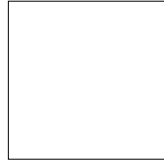

60 x 120 cm<sup>3/4</sup>



30 x 60 cm



30 x 120 cm



7 x 60 cm



Nom. dim. - cm/in	30 x 60 / 12 x 24	60 x 60 / 24 x 24	60 x 120 / 24 x 48	30 x 60 / 12 x 24	30 x 120 / 12 x 48	7 x 60 / 2 13/16 x 24
Work size	297 x 597 x 9 mm	597 x 597 x 9 mm	597 x 1197 x 9 mm	297 x 597 x 9 mm	297 x 1197 x 9 mm	70 x 597 x 9 mm
Surface	structured, matt	structured, matt	structured, matt	structured, matt	structured, matt	structured, matt
m <sup>2</sup> /m - pieces	5.556/m <sup>2</sup>	2.778/m <sup>2</sup>	1.388/m <sup>2</sup>	1.667/m	0.833/m	1.667/m
m <sup>2</sup> /m - kg	19.907/m <sup>2</sup>	20.371/m <sup>2</sup>	21.132/m <sup>2</sup>	5.973/m	6.341/m	1.357/m
Bundle - pieces	7	3	2	7	3	26
Bundle - m <sup>2</sup> /m	1.260 m <sup>2</sup>	1.080 m <sup>2</sup>	1.441 m <sup>2</sup>	4.199 m	3.601 m	8.998 m
Bundle - kg	25.081	21.999	30.450	25.081	22.836	21.164
Pallet - m <sup>2</sup>	50.396	45.356	50.432			
Pallet - kg	1,003.240	923.958	1,065.750			
Product standard	Bla	Bla	Bla	Bla	Bla	Bla
Slip resistance	R10/A+B	R10/A+B	R10/A+B	R10/A+B	R10/A+B	
Stress group	2	2	2	2	2	
dark taupe 	<b>431352H</b> Price gr. <b>A94</b> (m <sup>2</sup> )	<b>431356H</b> Price gr. <b>A106</b> (m <sup>2</sup> )	<b>431363H</b> Price gr. <b>A142</b> (m <sup>2</sup> )	<i>431367H</i> Price gr. <i>A456</i> (pce.)	<i>431371H</i> Price gr. <i>A522</i> (pce.)	<b>431395H</b> Price gr. <b>A438</b> (pce.)
light sand 	<b>431353H</b> Price gr. <b>A94</b> (m <sup>2</sup> )	<b>431357H</b> Price gr. <b>A106</b> (m <sup>2</sup> )	<b>431364H</b> Price gr. <b>A142</b> (m <sup>2</sup> )	<i>431368H</i> Price gr. <i>A456</i> (pce.)	<i>431372H</i> Price gr. <i>A522</i> (pce.)	<b>431396H</b> Price gr. <b>A438</b> (pce.)
warm grey 	<b>431354H</b> Price gr. <b>A94</b> (m <sup>2</sup> )	<b>431358H</b> Price gr. <b>A106</b> (m <sup>2</sup> )	<b>431365H</b> Price gr. <b>A142</b> (m <sup>2</sup> )	<i>431369H</i> Price gr. <i>A456</i> (pce.)	<i>431373H</i> Price gr. <i>A522</i> (pce.)	<b>431397H</b> Price gr. <b>A438</b> (pce.)
dark anthracite 	<b>431355H</b> Price gr. <b>A94</b> (m <sup>2</sup> )	<b>431359H</b> Price gr. <b>A106</b> (m <sup>2</sup> )	<b>431366H</b> Price gr. <b>A142</b> (m <sup>2</sup> )	<i>431370H</i> Price gr. <i>A456</i> (pce.)	<i>431374H</i> Price gr. <i>A522</i> (pce.)	<b>431398H</b> Price gr. <b>A438</b> (pce.)



<sup>3</sup> Please note: special pallet. No return, no exchange.  
<sup>4</sup> High weight only to carry with two persons.

Rendering







## Art in interior design

The Solid Ground series, designed in cooperation with the Hadi Teherani architecture office, combines concrete and travertine to create a harmonious design, which radiates stability and elegance. The series offers creative freedom with modern colors and a modular format system. Stair tiles in travertine look with a length of 145 cm are a highlight. Solid Ground provides varied and noble design possibilities for residential areas, offices, hotels and retail shops – a perfect solution for architects, planners and builders.

Rendering / Architect: Hadi Teherani

## Decoration elements



Wall tile 30 x 60 cm, 12 x 24 in, natural white, smooth



Decorative tile 30 x 60 cm, 12 x 24 in, natural white, relief



Wall tile 30 x 60 cm, 12 x 24 in, grey green, smooth



Decorative tile 30 x 60 cm, 12 x 24 in, grey green, relief



Wall tile 30 x 60 cm, 12 x 24 in, belgish grey, smooth



Decorative tile 30 x 60 cm, 12 x 24 in, belgish grey, relief



**R10/A+B**



Concrete



sand white

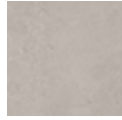

umber grey



warm grey



red clay

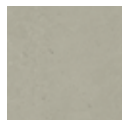

mud green

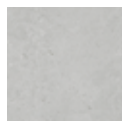

light grey

Travertine



italian white



belgish grey



urban grey



persian red



beach white



nordic grey



Floor tile 5 x 60 cm, 2 x 24 in, structured, R10/A+B



Floor tile 15 x 60 cm, 6 x 24 in, structured, R10/A+B (only available in Concrete)



Floor tile 30 x 60 cm, 12 x 24 in, structured, R10/A+B  
Floor tile 30 x 60 cm, 12 x 24 in, smooth, R10/A+B



Floor tile 60 x 60 cm, 24 x 24 in, structured, R10/A+B (only available in Concrete)



Travertine



italian white



belgish grey



urban grey



persian red



beach white



nordic grey



Floor tile 60 x 120 cm, 24 x 48 in, smooth, R10/A+B (only available in Travertine)





Concrete



sand white

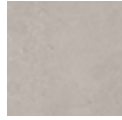

umber grey



warm grey



light grey



Floor tile 120 x 120 cm, structured, R10/A+B (only available in Concrete)



R10/A+B



Concrete



sand white

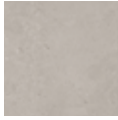

umber grey



warm grey



red clay

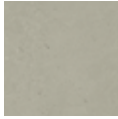

mud green



light grey

Travertine



italian white



belgish grey



urban grey



persian red



beach white



nordic grey



Stair tile 30 x 60 cm, 12 x 24 in (with grooves), structured, R10/A+B  
Stair tile 30 x 60 cm, 12 x 24 in (with grooves), smooth, R10/A+B

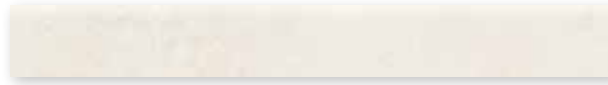

Skirting, rounded 7 x 60 cm, 2 13/16 x 24 in, structured  
Skirting, rounded 7 x 60 cm, 2 13/16 x 24 in, smooth



Stair tile with bevel 31 x 145 cm, 12 13/64 x 57 in, smooth, R10/A+B (only available in Travertine)



Riser 28 x 145 cm, 11 x 57 in, smooth, R10/A+B (only available in Travertine)



R10/A+B



## Mosaik 5 x 15, 2 x 6 in

### Concrete



Mosaic sheet 30 x 30 cm, 12 x 12 in  
sand white, smooth, R10/A+B



Mosaic sheet 30 x 30 cm, 12 x 12 in  
umber grey, smooth, R10/A+B



Mosaic sheet 30 x 30 cm, 12 x 12 in  
warm grey, smooth, R10/A+B

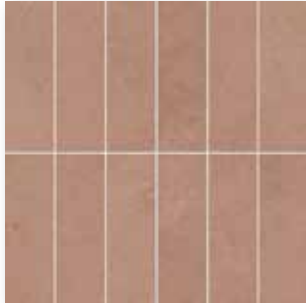

Mosaic sheet 30 x 30 cm, 12 x 12 in  
red clay, smooth, R10/A+B

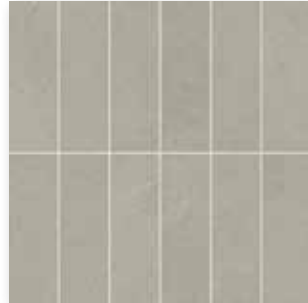

Mosaic sheet 30 x 30 cm, 12 x 12 in  
mud green, smooth, R10/A+B



Mosaic sheet 30 x 30 cm, 12 x 12 in  
light grey, smooth, R10/A+B

### Travertine



Mosaic sheet 30 x 30 cm, 12 x 12 in  
italian white, smooth, R10/A+B



Mosaic sheet 30 x 30 cm, 12 x 12 in  
belgish grey, smooth, R10/A+B



Mosaic sheet 30 x 30 cm, 12 x 12 in  
urban grey, smooth, R10/A+B



Mosaic sheet 30 x 30 cm, 12 x 12 in  
persian red, smooth, R10/A+B



Mosaic sheet 30 x 30 cm, 12 x 12 in  
beach white, smooth, R10/A+B



Mosaic sheet 30 x 30 cm, 12 x 12 in  
nordic grey, smooth, R10/A+B

Mosaic: glass fibre net on reverse side,  
sheet: 297 x 297 mm

Wall Tile<sup>2</sup>

Decoration Elements

Floor Tiles<sup>1</sup>

30 x 60 cm



30 x 60 cm

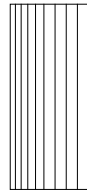

5 x 60 cm



5 x 60 cm



15 x 60 cm

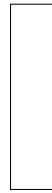

30 x 60 cm



30 x 60 cm

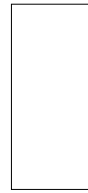

	Concrete	Concrete	Concrete	Travertine	Concrete	Concrete	Travertine
Nom. dim. - cm/in	30 x 60 / 12 x 24	30 x 60 / 12 x 24	5 x 60 / 2 x 24	5 x 60 / 2 x 24	15 x 60 / 6 x 24	30 x 60 / 12 x 24	30 x 60 / 12 x 24
Work size	297 x 597 x 6 mm	297 x 597 x 6 mm	47 x 597 x 9 mm	47 x 597 x 9 mm	147 x 597 x 9 mm	297 x 597 x 9 mm	297 x 597 x 9 mm
Surface	smooth, stone-matt	relief, stone-matt	strukturier, matt	smooth, matt	structured, matt	structured, matt	structured, matt
m <sup>2</sup> - pieces	5.556	5.556	33.333	33.333	11.111	5.556/m <sup>2</sup>	5.556/m <sup>2</sup>
m <sup>2</sup> - kg	10.279	10.279	6.633	6.633	19.900	19.907/m <sup>2</sup>	19.907/m <sup>2</sup>
Bundle - pieces	13	13	39	39	13	7	7
Bundle - m <sup>2</sup>	2.340	2.340	1.180	1.180	1.170	1.260 m <sup>2</sup>	1.260 m <sup>2</sup>
Bundle - kg	24.050	24.050	23.283	23.283	23.283	25.081	25.081
Pallet - m <sup>2</sup>	112.311	112.311	46.800	46.800	46.800	50.396	50.396
Pallet - kg	1,154.400	1,154.400	931.320	931.320	931.311	1,003.240	1,003.240
Product standard	BIII	BIII	Bla	Bla	Bla	Bla	Bla
Slip resistance			R10/A+B	R10/A+B	R10/A+B	R10/A+B	R10/A+B
Stress group			2	2	2	2	2
natural white <input type="checkbox"/>	<b>203505H</b> Price gr. C107 (m <sup>2</sup> )	<b>203506H</b> Price gr. C116 (m <sup>2</sup> )					
grey green <input type="checkbox"/>	<b>203507H</b> Price gr. C107 (m <sup>2</sup> )	<b>203508H</b> Price gr. C116 (m <sup>2</sup> )					
belgish grey <input type="checkbox"/>	<b>203509H</b> Price gr. C107 (m <sup>2</sup> )	<b>203510H</b> Price gr. C116 (m <sup>2</sup> )					
sand white <input type="checkbox"/>			<b>436110H</b> Price gr. C218 (m <sup>2</sup> )		<b>436116H</b> Price gr. C200 (m <sup>2</sup> )	<b>436122H</b> Price gr. C125 (m <sup>2</sup> )	
italian white <input type="checkbox"/>				<b>436156H</b> Price gr. C218 (m <sup>2</sup> )			<b>436162H</b> Price gr. C125 (m <sup>2</sup> )
umber grey <input type="checkbox"/>			<b>436111H</b> Price gr. C218 (m <sup>2</sup> )		<b>436117H</b> Price gr. C200 (m <sup>2</sup> )	<b>436123H</b> Price gr. C125 (m <sup>2</sup> )	
belgish grey <input type="checkbox"/>				<b>436157H</b> Price gr. C218 (m <sup>2</sup> )			<b>436163H</b> Price gr. C125 (m <sup>2</sup> )
warm grey <input type="checkbox"/>			<b>436112H</b> Price gr. C218 (m <sup>2</sup> )		<b>436118H</b> Price gr. C200 (m <sup>2</sup> )	<b>436124H</b> Price gr. C125 (m <sup>2</sup> )	
urban grey <input type="checkbox"/>				<b>436158H</b> Price gr. C218 (m <sup>2</sup> )			<b>436164H</b> Price gr. C125 (m <sup>2</sup> )
red clay <input type="checkbox"/>			<b>436113H</b> Price gr. C218 (m <sup>2</sup> )		<b>436119H</b> Price gr. C200 (m <sup>2</sup> )	<b>436125H</b> Price gr. C125 (m <sup>2</sup> )	
persian red <input type="checkbox"/>				<b>436159H</b> Price gr. C218 (m <sup>2</sup> )			<b>436165H</b> Price gr. C125 (m <sup>2</sup> )
mud green <input type="checkbox"/>			<b>436114H</b> Price gr. C218 (m <sup>2</sup> )		<b>436120H</b> Price gr. C200 (m <sup>2</sup> )	<b>436126H</b> Price gr. C125 (m <sup>2</sup> )	
beach white <input type="checkbox"/>				<b>436160H</b> Price gr. C218 (m <sup>2</sup> )			<b>436166H</b> Price gr. C125 (m <sup>2</sup> )
light grey <input type="checkbox"/>			<b>436115H</b> Price gr. C218 (m <sup>2</sup> )		<b>436121H</b> Price gr. C200 (m <sup>2</sup> )	<b>436127H</b> Price gr. C125 (m <sup>2</sup> )	
nordic grey <input type="checkbox"/>				<b>436161H</b> Price gr. C218 (m <sup>2</sup> )			<b>436167H</b> Price gr. C125 (m <sup>2</sup> )



<sup>2</sup> not frost-proof

### Floor Tiles<sup>1</sup>

### Mosaic<sup>5</sup>

60 x 60 cm

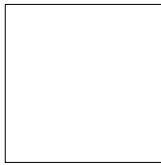

60 x 120 cm<sup>2/3</sup>



120 x 120 cm<sup>2/3/4</sup>

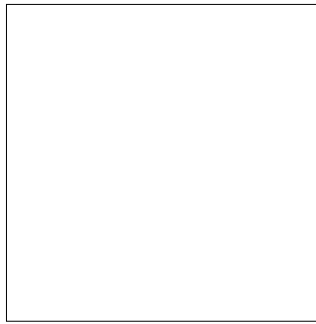

5 x 15 cm



5 x 15 cm



+

Concrete			Travertine			Concrete			Concrete Sheet 297 x 297 mm			Travertine Sheet 297 x 297 mm				
60 x 60 / 24 x 24	60 x 120 / 24 x 48	120 x 120 / 48 x 48	60 x 120 / 24 x 48	120 x 120 / 48 x 48	120 x 120 / 48 x 48	30 x 30 / 12 x 12	30 x 30 / 12 x 12	30 x 30 / 12 x 12	30 x 30 / 12 x 12	30 x 30 / 12 x 12	30 x 30 / 12 x 12	30 x 30 / 12 x 12	30 x 30 / 12 x 12	Nom. dim. - cm/in		
597 x 597 x 9 mm	597 x 1197 x 9 mm	1197 x 1197 x 9 mm	597 x 1197 x 9 mm	1197 x 1197 x 9 mm	1197 x 1197 x 9 mm	297 x 297 x 9 mm	297 x 297 x 9 mm	297 x 297 x 9 mm	297 x 297 x 9 mm	297 x 297 x 9 mm	297 x 297 x 9 mm	297 x 297 x 9 mm	297 x 297 x 9 mm	Work size		
structured, matt	smooth, matt	structured, matt	smooth, matt	structured, matt	structured, matt	structured, matt	smooth, matt	structured, matt	smooth, matt	structured, matt	smooth, matt	structured, matt	smooth, matt	Surface		
2.778	1.388	0.694	1.388	0.694	0.694	11.111	11.111	11.111	11.111	11.111	11.111	11.111	11.111	m <sup>2</sup> - pieces		
20.371	21.132	21.098	21.132	21.098	21.098	19.833	19.833	19.833	19.833	19.833	19.833	19.833	19.833	m <sup>2</sup> - kg		
3	2	2	2	2	2	12 sheets	12 sheets	12 sheets	12 sheets	12 sheets	12 sheets	12 sheets	12 sheets	Bundle - pieces		
1.080 m <sup>2</sup>	1.440 m <sup>2</sup>	2.882 m <sup>2</sup>	1.440 m <sup>2</sup>	2.882 m <sup>2</sup>	2.882 m <sup>2</sup>	0.1080	0.1080	0.1080	0.1080	0.1080	0.1080	0.1080	0.1080	Bundle - m <sup>2</sup>		
21.999	30.450	60.800	30.450	60.800	60.800	21.420	21.420	21.420	21.420	21.420	21.420	21.420	21.420	Bundle - kg		
45.356	50.432	57.637	50.432	57.637	57.637	32.400	32.400	32.400	32.400	32.400	32.400	32.400	32.400	Pallet - m <sup>2</sup>		
923.958	1,065.750	1,216.000	1,065.750	1,216.000	1,216.000	642.600	642.600	642.600	642.600	642.600	642.600	642.600	642.600	Pallet - kg		
Bla	Bla	Bla	Bla	Bla	Bla	Bla	Bla	Bla	Bla	Bla	Bla	Bla	Bla	Product standard		
R10/A+B	R10/A+B	R10/A+B	R10/A+B	R10/A+B	R10/A+B	R10/A+B	R10/A+B	R10/A+B	R10/A+B	R10/A+B	R10/A+B	R10/A+B	R10/A+B	Slip resistance		
2	2	2	2	2	2	2	2	2	2	2	2	2	2	Stress group		
<b>436128H</b>		<b>436134</b>		<b>436134</b>		<b>436138H</b>		<b>436138H</b>		<b>436138H</b>		<b>436138H</b>		sand white	V2	
Price gr. C140 (m <sup>2</sup> )		Price gr. C260 (m <sup>2</sup> )		Price gr. C260 (m <sup>2</sup> )		Price gr. C348 (m <sup>2</sup> )		Price gr. C348 (m <sup>2</sup> )		Price gr. C348 (m <sup>2</sup> )		Price gr. C348 (m <sup>2</sup> )		italian white	V3	
	<b>436168H</b>													umber grey	V2	
	Price gr. C152 (m <sup>2</sup> )													belgish grey	V3	
<b>436129H</b>		<b>436135</b>		<b>436135</b>		<b>436139H</b>		<b>436139H</b>		<b>436139H</b>		<b>436139H</b>		warm grey	V2	
Price gr. C140 (m <sup>2</sup> )		Price gr. C260 (m <sup>2</sup> )		Price gr. C260 (m <sup>2</sup> )		Price gr. C348 (m <sup>2</sup> )		Price gr. C348 (m <sup>2</sup> )		Price gr. C348 (m <sup>2</sup> )		Price gr. C348 (m <sup>2</sup> )		urban grey	V3	
	<b>436169H</b>													red clay	V2	
	Price gr. C152 (m <sup>2</sup> )													persian red	V3	
<b>436130H</b>		<b>436136</b>		<b>436136</b>		<b>436140H</b>		<b>436140H</b>		<b>436140H</b>		<b>436140H</b>		mud green	V2	
Price gr. C140 (m <sup>2</sup> )		Price gr. C260 (m <sup>2</sup> )		Price gr. C260 (m <sup>2</sup> )		Price gr. C348 (m <sup>2</sup> )		Price gr. C348 (m <sup>2</sup> )		Price gr. C348 (m <sup>2</sup> )		Price gr. C348 (m <sup>2</sup> )		beach white	V3	
	<b>436170H</b>													light grey	V2	
	Price gr. C152 (m <sup>2</sup> )													nordic grey	V3	
<b>436131H</b>		<b>436171H</b>		<b>436171H</b>		<b>436141H</b>		<b>436141H</b>		<b>436141H</b>		<b>436141H</b>				
Price gr. C140 (m <sup>2</sup> )		Price gr. C152 (m <sup>2</sup> )		Price gr. C152 (m <sup>2</sup> )		Price gr. C348 (m <sup>2</sup> )		Price gr. C348 (m <sup>2</sup> )		Price gr. C348 (m <sup>2</sup> )		Price gr. C348 (m <sup>2</sup> )				
	<b>436172H</b>															
	Price gr. C152 (m <sup>2</sup> )															
<b>436132H</b>		<b>436172H</b>		<b>436172H</b>		<b>436142H</b>		<b>436142H</b>		<b>436142H</b>		<b>436142H</b>				
Price gr. C140 (m <sup>2</sup> )		Price gr. C152 (m <sup>2</sup> )		Price gr. C152 (m <sup>2</sup> )		Price gr. C348 (m <sup>2</sup> )		Price gr. C348 (m <sup>2</sup> )		Price gr. C348 (m <sup>2</sup> )		Price gr. C348 (m <sup>2</sup> )				
	<b>436173H</b>															
	Price gr. C152 (m <sup>2</sup> )															
<b>436133H</b>		<b>436137</b>		<b>436137</b>		<b>436143H</b>		<b>436143H</b>		<b>436143H</b>		<b>436143H</b>				
Price gr. C140 (m <sup>2</sup> )		Price gr. C260 (m <sup>2</sup> )		Price gr. C260 (m <sup>2</sup> )		Price gr. C348 (m <sup>2</sup> )		Price gr. C348 (m <sup>2</sup> )		Price gr. C348 (m <sup>2</sup> )		Price gr. C348 (m <sup>2</sup> )				
	<b>436173H</b>															
	Price gr. C152 (m <sup>2</sup> )															



<sup>1</sup> High weight only to carry with two persons.

<sup>2</sup> Please note: special pallet. No return, no exchange.

<sup>3</sup> without Hytect coating; with Protecta upgrading

<sup>4</sup> Glass fibre net on reverse side



**Stair Tile<sup>1/2</sup>**

30 x 60 cm

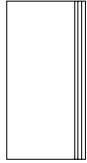

**Stair Tile with bevel<sup>2/3/4</sup>**

31 x 145 cm



**Riser<sup>2/3/4</sup>**

28 x 145 cm

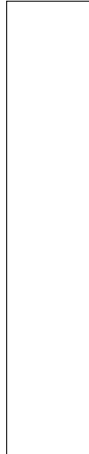

**Skirting, rounded<sup>1</sup>**

7 x 60 cm



7 x 60 cm



	Concrete	Travertine	Travertine	Concrete	Travertine		
Nom. dim. - cm/in	<b>30 x 60</b> / 12 x 24	<b>31 x 145</b> / 12 3/8 x 58	<b>28 x 145</b> / 11 3/16 x 58	<b>7 x 60</b> / 2 13/16 x 24	<b>7 x 60</b> / 2 13/16 x 24		
Work size	297 x 597 x 9 mm	307 x 1447 x 10.5 mm	280 x 1447 x 10.5 mm	70 x 597 x 9 mm	70 x 597 x 9 mm		
Surface	structured, matt	smooth, matt	smooth, matt	structured, matt	structured, matt		
m - pieces	1.667	0.690	0.690	1.667	1.667		
m - kg	5.973	7.480	6.716	1.357	1.357		
Bundle - pieces	7	2	2	15	15		
Bundle - m	4.199	2.899	2.899	8.998	8.998		
Bundle - kg	25.081	21.682	19.466	12.210	12.210		
Pallet - m <sup>2</sup>							
Pallet - kg							
Product standard	Bla	Ala	Ala	Bla	Bla		
Slip resistance	R10/A+B	R10/A+B	R10/A+B				
Stress group	2	2	2				
	<b>436144H</b> Price gr. C474 (pce.)			<b>436150H</b> Price gr. C440 (pce.)			
sand white <input type="checkbox"/> V2		<b>436180H</b> Price gr. C558 (pce.)	<b>436186H</b> Price gr. C525 (pce.)		<b>436192H</b> Price gr. C440 (pce.)		
italian white <input type="checkbox"/> V3							
umber grey <input type="checkbox"/> V2	<b>436145H</b> Price gr. C474 (pce.)			<b>436151H</b> Price gr. C440 (pce.)			
belgish grey <input type="checkbox"/> V3		<b>436181H</b> Price gr. C558 (pce.)	<b>436187H</b> Price gr. C525 (pce.)		<b>436193H</b> Price gr. C440 (pce.)		
warm grey <input type="checkbox"/> V2	<b>436146H</b> Price gr. C474 (pce.)			<b>436152H</b> Price gr. C440 (pce.)			
urban grey <input type="checkbox"/> V3		<b>436182H</b> Price gr. C558 (pce.)	<b>436188H</b> Price gr. C525 (pce.)		<b>436194H</b> Price gr. C440 (pce.)		
red clay <input type="checkbox"/> V2	<b>436147H</b> Price gr. C474 (pce.)			<b>436153H</b> Price gr. C440 (pce.)			
persian red <input type="checkbox"/> V3		<b>436183H</b> Price gr. C558 (pce.)	<b>436189H</b> Price gr. C525 (pce.)		<b>436195H</b> Price gr. C440 (pce.)		
mud green <input type="checkbox"/> V2	<b>436148H</b> Price gr. C474 (pce.)			<b>436154H</b> Price gr. C440 (pce.)			
beach white <input type="checkbox"/> V3		<b>436184H</b> Price gr. C558 (pce.)	<b>436190H</b> Price gr. C525 (pce.)		<b>436196H</b> Price gr. C440 (pce.)		
light grey <input type="checkbox"/> V2	<b>436149H</b> Price gr. C474 (pce.)			<b>436155H</b> Price gr. C440 (pce.)			
nordic grey <input type="checkbox"/> V3		<b>436185H</b> Price gr. C558 (pce.)	<b>436191H</b> Price gr. C525 (pce.)		<b>436197H</b> Price gr. C440 (pce.)		

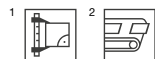

<sup>3</sup> Rectified only on the two short sides. The long side can not be rectified.

<sup>4</sup> For details, refer to page 538

Rendering / Architect: Hadi Teherani









## Naturally expressive

Solid Rock – this name alone is a clear statement. And the robust quality of this series is almost set in stone. Solid Rock eliminates the boundaries between inside and outside. Purely aesthetically, because it brings the power of nature into bathrooms, foyers and all other rooms. But there are also unlimited possibilities when it comes to laying. Because interior tiles in combination with Solid Rock patio tiles create seamless transitions between indoors and outdoors. A highlight for hotels and restaurants, but also in private living areas. The lively structure of the tiles accentuates rooms clearly and stringently. The Move wall bond further expands the design freedom for architects and planners. This is due to the different and carefully selected color shades in which this aesthetically truly stunning tile is available. Solid Rock is Protecta-upgraded and thus resistant to dirt and stains.

Rendering / Architect: VSBL, Belgrade, Serbia



R10/A+B



dark green

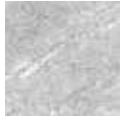

silver

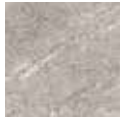

mud grey

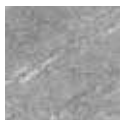

natural grey



deep grey



Wall/Floor tile 5 x 60 cm, 2 x 24 in, structured, R10/A+B



Wall/Floor tile 10 x 60 cm, 4 x 24 in, structured, R10/A+B



Wall/Floor tile 15 x 60 cm, 6 x 24 in, structured, R10/A+B



Wall/Floor tile 30 x 60 cm, 12 x 24 in, structured, R10/A+B



Wall/Floor tile 60 x 60 cm, 24 x 24 in, structured, R10/A+B



Wall/Floor tile 60 x 120 cm, 24 x 48 in, structured, R10/A+B



Stair tile 30 x 60 cm, 12 x 24 in (with grooves), structured, R10/A+B



Skirting, rounded 7 x 60 cm, 2 13/16 x 24 in, structured



dark green

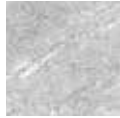

silver



mud grey



natural grey



deep grey



Patio tile 60 x 60 cm, 24 x 24 in, structured, R11/B



Patio tile 60 x 120 cm, 24 x 48 in, structured, R11/B



### Mosaic 5 x 5 cm, 2 x 2 in



Mosaic sheet 30 x 30 cm, 12 x 12 in dark green, structured, R10/A+B

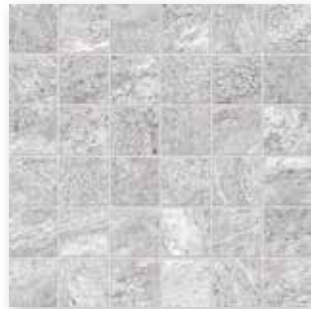

Mosaic sheet 30 x 30 cm, 12 x 12 in silver, structured, R10/A+B



Mosaic sheet 30 x 30 cm, 12 x 12 in mud grey, structured, R10/A+B

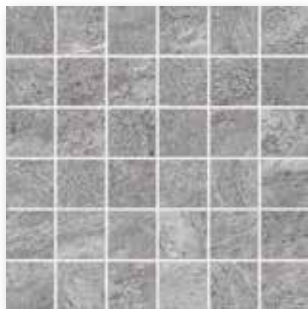

Mosaic sheet 30 x 30 cm, 12 x 12 in natural grey, structured, R10/A+B



Mosaic sheet 30 x 30 cm, 12 x 12 in deep grey, structured, R10/A+B

Glass fibre net on reverse side, Sheet: 297 x 297 mm.

### Decoration elements

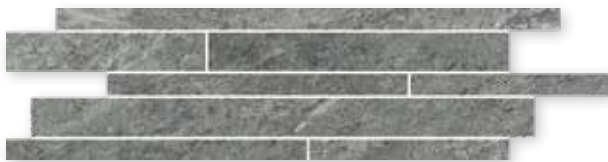

Border Move 15 x 60 cm, 6 x 24 in, dark green, structured, R10/A+B



Border Move 15 x 60 cm, 6 x 24 in, silver, structured, R10/A+B



Border Move 15 x 60 cm, 6 x 24 in, mud grey, structured, R10/A+B



Border Move 15 x 60 cm, 6 x 24 in, natural grey, structured, R10/A+B



Border Move 15 x 60 cm, 6 x 24 in, deep grey, structured, R10/A+B

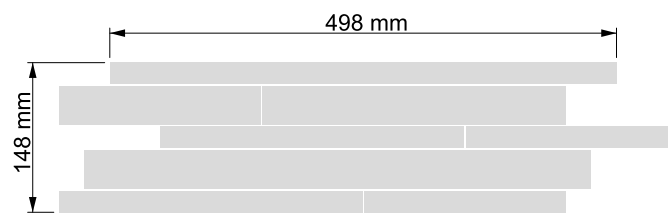

Glass fibre net on reverse side, Sheet: 148 x 598 mm

## Mosaic<sup>1/3</sup> Wall and Floor Tiles<sup>1</sup>

5 x 5 cm



5 x 60 cm<sup>2</sup>



10 x 60 cm<sup>2</sup>



15 x 60 cm<sup>2</sup>



30 x 60 cm



60 x 60 cm

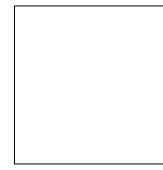



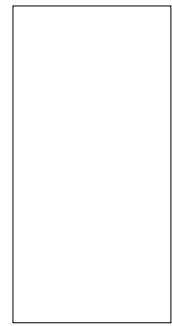

60 x 120 cm<sup>4/5</sup>



protected

Sheet: 297 x 297 mm

Nom. dim. - cm/in	5 x 5 / 2 x 2	5 x 60 / 2 x 24	10 x 60 / 4 x 24	15 x 60 / 6 x 24	30 x 60 / 12 x 24	60 x 60 / 24 x 24	60 x 120 / 24 x 48
Work size	47 x 47 x 9 mm	46 x 596 x 9 mm	96 x 596 x 9 mm	146 x 596 x 9 mm	297 x 596 x 9 mm	596 x 596 x 9 mm	596 x 1194 x 9 mm
Surface	structured, matt	structured, matt	structured, matt	structured, matt	structured, matt	structured, matt	structured, matt
m <sup>2</sup> - pieces	11.111 sheets	33.333	16.667	11.111	5.556	2.778	1.388
m <sup>2</sup> - kg	19.833	19.899	20.283	19.899	19.841	19.288	21.514
Bundle - pieces	12 sheets	39	17	13	7	3	2
Bundle - m <sup>2</sup>	1.080 m <sup>2</sup>	1.170	1.020	1.170	1.260	1.080	1.441
Bundle - kg	21.420	23.283	20.689	23.283	24.997	20.829	31.000
Pallet - m <sup>2</sup>	32.400	46.800	40.799	46.800	50.396	43.197	50.432
Pallet - kg	642.600	931.320	827.560	931.320	999.880	833.160	1,085.000
Product standard	Bla	Bla	Bla	Bla	Bla	Bla	Bla
Slip resistance	R10/A+B	R10/A+B	R10/A+B	R10/A+B	R10/A+B	R10/A+B	R10/A+B
Stress group	2	2	2	2	2	2	2
dark green 	<b>431020</b> Price gr. <b>W303</b> (m <sup>2</sup> )	<i>431021</i> Price gr. <i>W210</i> (m <sup>2</sup> )	<i>431022</i> Price gr. <i>W210</i> (m <sup>2</sup> )	<i>431023</i> Price gr. <i>W186</i> (m <sup>2</sup> )	<b>431024</b> Price gr. <b>W102</b> (m <sup>2</sup> )	<b>431025</b> Price gr. <b>W117</b> (m <sup>2</sup> )	<b>431026</b> Price gr. <b>W156</b> (m <sup>2</sup> )
silver 	<b>430853</b> Price gr. <b>W303</b> (m <sup>2</sup> )	<i>430857</i> Price gr. <i>W210</i> (m <sup>2</sup> )	<i>430861</i> Price gr. <i>W210</i> (m <sup>2</sup> )	<i>430865</i> Price gr. <i>W186</i> (m <sup>2</sup> )	<b>430869</b> Price gr. <b>W102</b> (m <sup>2</sup> )	<b>430873</b> Price gr. <b>W117</b> (m <sup>2</sup> )	<b>430877</b> Price gr. <b>W156</b> (m <sup>2</sup> )
mud grey 	<b>430854</b> Price gr. <b>W303</b> (m <sup>2</sup> )	<i>430858</i> Price gr. <i>W210</i> (m <sup>2</sup> )	<i>430862</i> Price gr. <i>W210</i> (m <sup>2</sup> )	<i>430866</i> Price gr. <i>W186</i> (m <sup>2</sup> )	<b>430870</b> Price gr. <b>W102</b> (m <sup>2</sup> )	<b>430874</b> Price gr. <b>W117</b> (m <sup>2</sup> )	<b>430878</b> Price gr. <b>W156</b> (m <sup>2</sup> )
natural grey 	<b>430855</b> Price gr. <b>W303</b> (m <sup>2</sup> )	<i>430859</i> Price gr. <i>W210</i> (m <sup>2</sup> )	<i>430863</i> Price gr. <i>W210</i> (m <sup>2</sup> )	<i>430867</i> Price gr. <i>W186</i> (m <sup>2</sup> )	<b>430871</b> Price gr. <b>W102</b> (m <sup>2</sup> )	<b>430875</b> Price gr. <b>W117</b> (m <sup>2</sup> )	<b>430879</b> Price gr. <b>W156</b> (m <sup>2</sup> )
deep grey 	<b>430856</b> Price gr. <b>W303</b> (m <sup>2</sup> )	<i>430860</i> Price gr. <i>W210</i> (m <sup>2</sup> )	<i>430864</i> Price gr. <i>W210</i> (m <sup>2</sup> )	<i>430868</i> Price gr. <i>W186</i> (m <sup>2</sup> )	<b>430872</b> Price gr. <b>W102</b> (m <sup>2</sup> )	<b>430876</b> Price gr. <b>W117</b> (m <sup>2</sup> )	<b>430880</b> Price gr. <b>W156</b> (m <sup>2</sup> )



<sup>1</sup> Glass fibre net on reverse side

<sup>4</sup> High weight only to carry with two persons.

<sup>5</sup> Please note: special pallet. No return, no exchange.

Decoration  
Elements<sup>1/5/6</sup>

15 x 60 cm



Stair  
Tile<sup>1/2</sup>

30 x 60 cm



Skirting,  
rounded<sup>1</sup>

7 x 60 cm



Patio Tiles<sup>1/3</sup>

60 x 60 cm

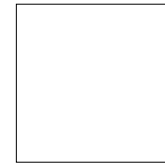

60 x 120 cm<sup>4</sup>

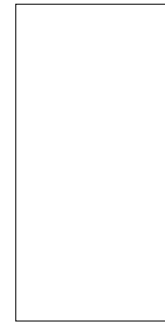

protected

Border Move  
Sheet: 148 x 598 mm

	15 x 60 / 6 x 24	30 x 60 / 12 x 24	7 x 60 / 2 13/16 x 24	60 x 60 / 24 x 24	60 x 120 / 24 x 48	Nom. dim. - cm/in
	148 x 598 x 9 mm	297 x 596 x 9 mm	70 x 596 x 9 mm	596 x 596 x 20 mm	596 x 1194 x 20 mm	Work size
	structured, matt	structured, matt	structured, matt	structured, matt	structured, matt	Surface
	2.000/m	1.667/m	1.667/m	2.778/m <sup>2</sup>	1.388/m <sup>2</sup>	m <sup>2</sup> - pieces
	2.780/m	5.973/m	1.357/m	47.226/m <sup>2</sup>	45.110/m <sup>2</sup>	m <sup>2</sup> - kg
	2	7	22	2	1	Bundle - pieces
	1.000 m	4.199 m	13.197 m	0.720 m <sup>2</sup>	0.720 m <sup>2</sup>	Bundle - m <sup>2</sup>
	2.780	25.081	17.908	34.000	32.500	Bundle - kg
				21.598	25.216	Pallet - m <sup>2</sup>
				1,020.000	1,137.500	Pallet - kg
	Bla	Bla	Bla	Bla	Bla	Product standard
	R10/A+B	R10/A+B		R11/B	R11/B	Slip resistance
	2	2		4	4	Stress group
	<b>431029</b>	<b>431030</b>	<b>431031</b>	<b>431027</b>	<b>431028</b>	
	Price gr. <b>W488</b> (pce.)	Price gr. <b>W473</b> (pce.)	Price gr. <b>W439</b> (pce.)	Price gr. <b>W177</b> (m <sup>2</sup> )	Price gr. <b>W216</b> (m <sup>2</sup> )	dark green <input type="checkbox"/> V2
	<b>430897</b>	<b>430893</b>	<b>430889</b>	<b>430881</b>	<b>430885</b>	silver <input type="checkbox"/> V2
	Price gr. <b>W488</b> (pce.)	Price gr. <b>W473</b> (pce.)	Price gr. <b>W439</b> (pce.)	Price gr. <b>W177</b> (m <sup>2</sup> )	Price gr. <b>W216</b> (m <sup>2</sup> )	
	<b>430898</b>	<b>430894</b>	<b>430890</b>	<b>430882</b>	<b>430886</b>	mud grey <input type="checkbox"/> V2
	Price gr. <b>W488</b> (pce.)	Price gr. <b>W473</b> (pce.)	Price gr. <b>W439</b> (pce.)	Price gr. <b>W177</b> (m <sup>2</sup> )	Price gr. <b>W216</b> (m <sup>2</sup> )	
	<b>430899</b>	<b>430895</b>	<b>430891</b>	<b>430883</b>	<b>430887</b>	natural grey <input type="checkbox"/> V2
	Price gr. <b>W488</b> (pce.)	Price gr. <b>W473</b> (pce.)	Price gr. <b>W439</b> (pce.)	Price gr. <b>W177</b> (m <sup>2</sup> )	Price gr. <b>W216</b> (m <sup>2</sup> )	
	<b>430900</b>	<b>430896</b>	<b>430892</b>	<b>430884</b>	<b>430888</b>	deep grey <input type="checkbox"/> V2
	Price gr. <b>W488</b> (pce.)	Price gr. <b>W473</b> (pce.)	Price gr. <b>W439</b> (pce.)	Price gr. <b>W177</b> (m <sup>2</sup> )	Price gr. <b>W216</b> (m <sup>2</sup> )	

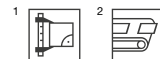

- <sup>3</sup> High weight only to carry with two persons.  
<sup>4</sup> Please note: special pallet. No return, no exchange.  
<sup>5</sup> Glass fibre net on reverse side  
<sup>6</sup> Decoration elements only available in full boxes.









## Classics for the bathroom

If plain white tiled walls previously were considered perhaps the most timeless setting for the bathroom, then Stone Concept is another variant which has what it takes to become a classic: organic marble and natural stone looks in the proven 30 x 60 cm format create a cosy, warm ambience and transform the bathroom into a feel-good oasis. With six different designs and surfaces ranging from transparent glossy to stone-matt, the series opens up flexible design options and always remains a timeless setting in its natural simplicity for the private retreat or the hotel bathroom.

Rendering

### Decoration elements



Wall tile 30 x 60 cm, 12 x 24 in, Calacatta gold, smooth, glossy



Decorative tile 30 x 60 cm, 12 x 24 in, Calacatta gold, relief, glossy



Wall tile 30 x 60 cm, 12 x 24 in, Calacatta gold, smooth, silky matt



Decorative tile 30 x 60 cm, 12 x 24 in, Calacatta gold, relief, silky matt



Wall tile 30 x 60 cm, 12 x 24 in, Carrara bianco, smooth, glossy

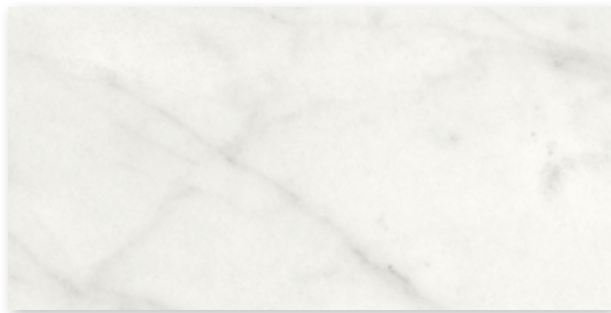

Wall tile 30 x 60 cm, 12 x 24 in, Carrara bianco, smooth, silky matt



Wall tile 30 x 60 cm, 12 x 24 in, Patagonia, smooth, glossy



Wall tile 30 x 60 cm, 12 x 24 in, Vals Stone sand-beige, structured, stone-matt



Wall tile 30 x 60 cm, 12 x 24 in, Patagonia, smooth, stone-matt



Wall tile 30 x 60 cm, 12 x 24 in, Vals Stone anthracite, structured, stone-matt

### Decoration elements



Wall tile 30 x 60 cm, 12 x 24 in, Silk Stone powder-beige, smooth, silky matt



Decorative tile 30 x 60 cm, 12 x 24 in, Silk Stone puderbeige, relief, silky matt



Wall tile 30 x 60 cm, 12 x 24 in, Silk Stone pebble-grey, smooth, silky matt



Decorative tile 30 x 60 cm, 12 x 24 in, Silk Stone pebble-grey, relief, silky matt

### Decoration elements



Wall tile 30 x 60 cm, 12 x 24 in, Travertin cream beige, smooth, silky matt



Decorative tile 30 x 60 cm, 12 x 24 in, Travertin cream beige, relief, silky matt



Wall tile 30 x 60 cm, 12 x 24 in, Travertin grey beige, smooth, silky matt



Decorative tile 30 x 60 cm, 12 x 24 in, Travertin grey beige, relief, silky matt

Wall Tile

Decoration  
Element

Wall Tile

Decoration  
Element

Wall Tiles

30 x 60 cm

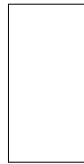

Decorative tile

Decorative tile

	30 x 60 / 12 x 24	30 x 60 / 12 x 24	30 x 60 / 12 x 24	30 x 60 / 12 x 24	30 x 60 / 12 x 24	30 x 60 / 12 x 24	Nom. dim. - cm/in
	297 x 597 x 6 mm	297 x 597 x 6 mm	297 x 597 x 6 mm	297 x 597 x 6 mm	297 x 597 x 6 mm	297 x 597 x 6 mm	Work size
	smooth, glossy	relief, glossy	smooth, silky-matt	relief, silky-matt	smooth, stone-matt	structured, stone-matt	Surface
	5.556	5.556	5.556	5.556	5.556	5.556	m <sup>2</sup> - pieces
	10.279	10.279	10.279	10.279	10.279	10.279	m <sup>2</sup> - kg
	13	11	13	11	13	13	Bundle - pieces
	2.340	1.980	2.340	1.980	2.340	2.340	Bundle - m <sup>2</sup>
	24.050	21.241	24.050	21.241	24.050	24.050	Bundle - kg
	112.311	95.032	112.311	95.032	112.311	112.311	Pallet - m <sup>2</sup>
	1,154.400	1,019.568	1,154.400	1,019.568	1,154.400	1,154.400	Pallet - kg
	BIII	BIII	BIII	BIII	BIII	BIII	Product standard
	<b>203511</b>	<b>203514</b>	<b>203515</b>	<b>203521</b>			Calacatta gold <input type="checkbox"/> V3
	Price gr. C56 (m <sup>2</sup> )	Price gr. C56 (m <sup>2</sup> )	Price gr. C56 (m <sup>2</sup> )	Price gr. C56 (m <sup>2</sup> )			
	<b>203512</b>		<b>203516</b>				Carrara bianco <input type="checkbox"/> V2
	Price gr. C56 (m <sup>2</sup> )		Price gr. C56 (m <sup>2</sup> )				
	<b>203513</b>				<b>203526</b>		Patagonia <input type="checkbox"/> V4
	Price gr. C56 (m <sup>2</sup> )				Price gr. C56 (m <sup>2</sup> )		
						<b>203527</b>	Vals Stone
						Price gr. C56 (m <sup>2</sup> )	sand-beige <input type="checkbox"/> V2
						<b>203528</b>	Vals Stone
						Price gr. C56 (m <sup>2</sup> )	anthracite <input type="checkbox"/> V2
			<b>203517</b>	<b>203522</b>			Silk Stone
			Price gr. C56 (m <sup>2</sup> )	Price gr. C56 (m <sup>2</sup> )			powder-beige <input type="checkbox"/> V2
			<b>203518</b>	<b>203523</b>			Silk Stone
			Price gr. C56 (m <sup>2</sup> )	Price gr. C56 (m <sup>2</sup> )			pebble-grey <input type="checkbox"/> V2
			<b>203519</b>	<b>203524</b>			Travertin
			Price gr. C56 (m <sup>2</sup> )	Price gr. C56 (m <sup>2</sup> )			cream-beige <input type="checkbox"/> V2
			<b>203520</b>	<b>203525</b>			Travertin
			Price gr. C56 (m <sup>2</sup> )	Price gr. C56 (m <sup>2</sup> )			grey beige <input type="checkbox"/> V3





## Natural elegance

The Stone design combines soft grains, natural veinings and subtle shades to create a cosy look. The color range includes shades from beige to anthracite and emphasizes the naturalness and elegance of the tiles. The tiles of the Stone Duo series are all provided with the innovative and easy-to-clean Hytect surface. This feature not only ensures easy care, but also long-lasting beauty and makes the series the ideal choice for demanding builders.

Rendering



R10/A+B



light-grey



mud



beige

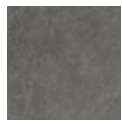

anthracite



Floor tile, Design Stone, 30 x 60 cm, 12 x 24 in, structured, R10/A+B



Floor tile, Design Ceppo, 30 x 60 cm, 12 x 24 in, structured, R10/A+B



Floor tile, Design Stone, 60 x 60 cm, 24 x 24 in, structured, R10/A+B



Floor tile, Design Ceppo, 60 x 60 cm, 24 x 24 in, structured, R10/A+B



Floor tile, Design Stone, 60 x 120 cm, 24 x 48 in, structured, R10/A+B



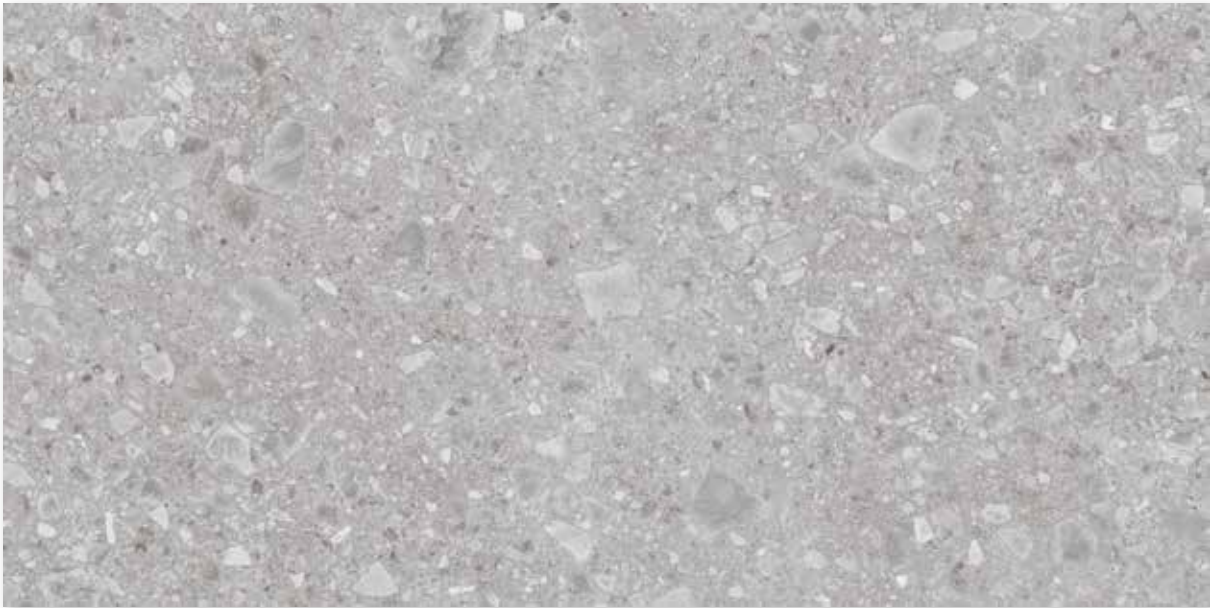

Floor tile, Design Ceppo, 60 x 120 cm, 24 x 48 in, structured, R10/A+B



Stair tile, Design Stone, 30 x 60 cm, 12 x 24 in (with grooves), structured, R10/A+B



Stair tile, Design Ceppo, 30 x 60 cm, 12 x 24 in (with grooves), structured, R10/A+B



Skirting, rounded, Design Stone, 7 x 60 cm, 2 13/16 x 24 in, structured



Skirting, rounded, Design Ceppo, 7 x 60 cm, 2 13/16 x 24 in, structured

Mosaik 5 x 5, 2 x 2 in

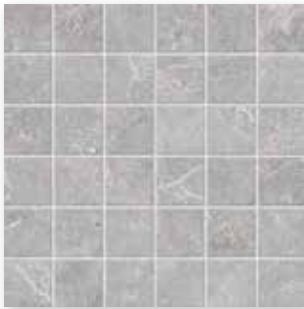

Mosaic sheet, Design Stone  
30 x 30 cm, 12 x 12 in, light-grey,  
structured, R10/A+B

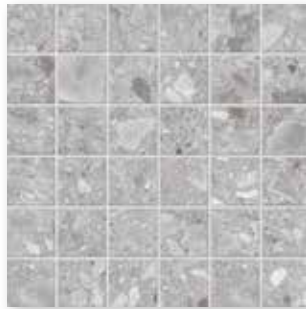

Mosaic sheet, Design Ceppo  
30 x 30 cm, 12 x 12 in, light-grey,  
structured, R10/A+B



Mosaic sheet, Design Stone  
30 x 30 cm, 12 x 12 in, mud,  
structured, R10/A+B

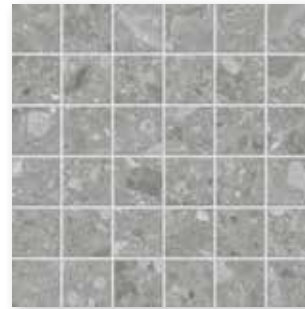

Mosaic sheet, Design Ceppo  
30 x 30 cm, 12 x 12 in, mud,  
structured, R10/A+B



Mosaic sheet, Design Stone  
30 x 30 cm, 12 x 12 in, beige,  
structured, R10/A+B



Mosaic sheet, Design Ceppo  
30 x 30 cm, 12 x 12 in, beige,  
structured, R10/A+B

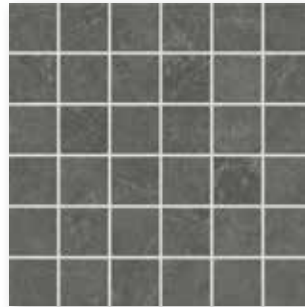

Mosaic sheet, Design Stone  
30 x 30 cm, 12 x 12 in, anthracite,  
structured, R10/A+B

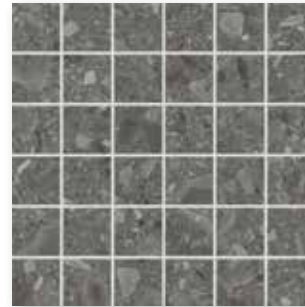

Mosaic sheet, Design Ceppo  
30 x 30 cm, 12 x 12 in, anthracite,  
structured, R10/A+B

Decoration elements

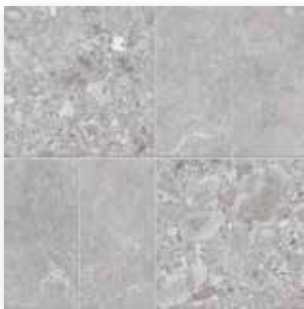

Mosaic sheet, Design Twins  
30 x 30 cm, 12 x 12 in, light-grey,  
structured, R10/A+B



Mosaic sheet, Design Twins  
30 x 30 cm, 12 x 12 in, mud,  
structured, R10/A+B



Mosaic sheet, Design Twins  
30 x 30 cm, 12 x 12 in, beige,  
structured, R10/A+B

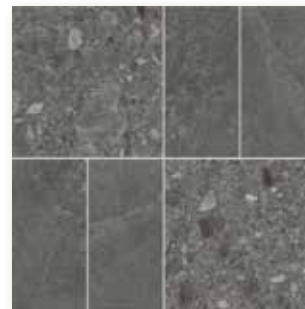

Mosaic sheet, Design Twins  
30 x 30 cm, 12 x 12 in, anthracite,  
structured, R10/A+B

Mosaic: glass fibre net on reverse side,  
sheet: 297 x 297 mm

Mosaic<sup>1/2</sup>

Floor Tiles<sup>1</sup>

5 x 5 cm



5 x 5 cm



30 x 60 cm

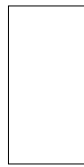

30 x 60 cm



60 x 60 cm

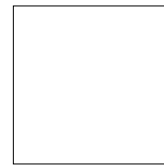

60 x 60 cm



Stone		Ceppo		Stone		Ceppo		Nom. dim. - cm/in
Sheet: 297 x 297 mm		Sheet: 297 x 297 mm		Sheet: 297 x 297 mm		Sheet: 297 x 297 mm		
<b>5 x 5 / 2 x 2</b>	<b>5 x 5 / 2 x 2</b>	<b>30 x 60 / 12 x 24</b>	<b>30 x 60 / 12 x 24</b>	<b>60 x 60 / 24 x 24</b>	<b>60 x 60 / 24 x 24</b>			Work size
47 x 47 x 9 mm	47 x 47 x 9 mm	297 x 597 x 9 mm	297 x 597 x 9 mm	597 x 597 x 9 mm	597 x 597 x 9 mm			Surface
structured, matt	structured, matt	structured, matt	structured, matt	structured, matt	structured, matt			m <sup>2</sup> - pieces
11.111 sheets	11.111 sheets	5.556	5.556	2.778	2.778			m <sup>2</sup> - kg
19.833	19.833	19.907	19.907	20.371	20.371			Bundle - pieces
12 sheets	12 sheets	7	7	3	3			Bundle - m <sup>2</sup>
1.080	1.080	1.260	1.260	1.080	1.080			Bundle - kg
21.420	21.420	25.081	25.081	21.999	21.999			Pallet - m <sup>2</sup>
32.400	32.400	50.396	50.396	45.356	45.356			Pallet - kg
642.600	642.600	1,003.240	1,003.240	923.958	923.958			Product standard
Bla	Bla	Bla	Bla	Bla	Bla			Slip resistance
R10/A+B	R10/A+B	R10/A+B	R10/A+B	R10/A+B	R10/A+B			Stress group
2	2	2	2	2	2			
<b>435948H</b>		<b>435956H</b>		<b>435964H</b>				light-grey <input type="checkbox"/> V2
Price gr. C293 (m <sup>2</sup> )		Price gr. C116 (m <sup>2</sup> )		Price gr. C128 (m <sup>2</sup> )				light-grey <input type="checkbox"/> V3
	<b>435952H</b>		<b>435960H</b>		<b>435968H</b>			
	Price gr. C293 (m <sup>2</sup> )		Price gr. C125 (m <sup>2</sup> )		Price gr. C140 (m <sup>2</sup> )			mud <input type="checkbox"/> V2
<b>435949H</b>		<b>435957H</b>		<b>435965H</b>				mud <input type="checkbox"/> V3
Price gr. C293 (m <sup>2</sup> )		Price gr. C116 (m <sup>2</sup> )		Price gr. C128 (m <sup>2</sup> )				beige <input type="checkbox"/> V2
	<b>435953H</b>		<b>435961H</b>		<b>435969H</b>			beige <input type="checkbox"/> V3
	Price gr. C293 (m <sup>2</sup> )		Price gr. C125 (m <sup>2</sup> )		Price gr. C140 (m <sup>2</sup> )			anthracite <input type="checkbox"/> V2
<b>435950H</b>		<b>435958H</b>		<b>435966H</b>				anthracite <input type="checkbox"/> V3
Price gr. C293 (m <sup>2</sup> )		Price gr. C116 (m <sup>2</sup> )		Price gr. C128 (m <sup>2</sup> )				
	<b>435954H</b>		<b>435962H</b>		<b>435970H</b>			
	Price gr. C293 (m <sup>2</sup> )		Price gr. C125 (m <sup>2</sup> )		Price gr. C140 (m <sup>2</sup> )			
<b>435951H</b>		<b>435959H</b>		<b>435967H</b>				
Price gr. C293 (m <sup>2</sup> )		Price gr. C116 (m <sup>2</sup> )		Price gr. C128 (m <sup>2</sup> )				
	<b>435955H</b>		<b>435963H</b>		<b>435971H</b>			
	Price gr. C293 (m <sup>2</sup> )		Price gr. C125 (m <sup>2</sup> )		Price gr. C140 (m <sup>2</sup> )			



<sup>2</sup> Glass fibre net on reverse side



**Floor Tiles<sup>1</sup>**

**Decoration Elements<sup>1</sup>**

**Stair Tiles<sup>1/2</sup>**

**Skirting, rounded<sup>1</sup>**

60 x 120 cm<sup>3/4</sup>

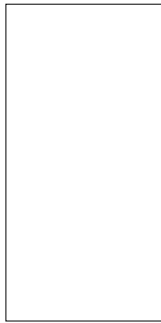

60 x 120 cm<sup>3/4</sup>

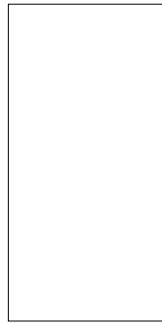

30 x 30 cm



30 x 60 cm



30 x 60 cm

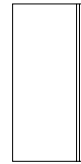

7 x 60 cm



7 x 60 cm



	Stone	Ceppo	Twins Sheet 297 x 297 mm	Stone	Ceppo	Stone	Ceppo
Nom. dim. - cm/in	<b>60 x 120</b> / 24 x 48	<b>60 x 120</b> / 24 x 48	<b>30 x 30</b> / 12 x 12	<b>30 x 60</b> / 12 x 24	<b>30 x 60</b> / 12 x 24	<b>7 x 60</b> / 2 13/16 x 24	<b>7 x 60</b> / 2 13/16 x 24
Work size	597 x 1197 x 9 mm	597 x 1197 x 9 mm	297 x 297 x 9 mm	297 x 597 x 9 mm	297 x 597 x 9 mm	70 x 597 x 9 mm	70 x 597 x 9 mm
Surface	structured, matt	structured, matt	structured, matt	structured, matt	structured, matt	structured, matt	structured, matt
m <sup>2</sup> /m - pieces	1.388/m <sup>2</sup>	1.388/m <sup>2</sup>	3.333/m	1.667/m	1.667/m	1.667/m	1.667/m
m <sup>2</sup> /m - kg	21.132/m <sup>2</sup>	21.132/m <sup>2</sup>	5.942/m	5.973/m	5.973/m	1.357/m	1.357/m
Bundle - pieces	2	2	4	7	7	15	15
Bundle - m <sup>2</sup> /m	1.440 m <sup>2</sup>	1.440 m <sup>2</sup>	1.200 m	4.199 m	4.199 m	8.998 m	8.998 m
Bundle - kg	30.450	30.450	7.132	25.081	25.081	12.210	12.210
Pallet - m <sup>2</sup>	50.432	50.432					
Pallet - kg	1,065.750	1,065.750					
Product standard	Bla	Bla	Bla	Bla	Bla	Bla	Bla
Slip resistance	R10/A+B	R10/A+B	R10/A+B	R10/A+B	R10/A+B		
Stress group	2	2	2	2	2		
	<b>435972H</b> Price gr. <b>C149</b> (m <sup>2</sup> )		<b>435980H</b> Price gr. <b>C517</b> (pce.)	<b>435984H</b> Price gr. <b>C474</b> (pce.)		<b>435992H</b> Price gr. <b>C440</b> (pce.)	
light-grey		<b>435976H</b> Price gr. <b>C152</b> (m <sup>2</sup> )			<b>435988H</b> Price gr. <b>C474</b> (pce.)		<b>435996H</b> Price gr. <b>C440</b> (pce.)
light-grey							
mud	<b>435973H</b> Price gr. <b>C149</b> (m <sup>2</sup> )		<b>435981H</b> Price gr. <b>C517</b> (pce.)	<b>435985H</b> Price gr. <b>C474</b> (pce.)		<b>435993H</b> Price gr. <b>C440</b> (pce.)	
mud		<b>435977H</b> Price gr. <b>C152</b> (m <sup>2</sup> )			<b>435989H</b> Price gr. <b>C474</b> (pce.)		<b>435997H</b> Price gr. <b>C440</b> (pce.)
beige	<b>435974H</b> Price gr. <b>C149</b> (m <sup>2</sup> )		<b>435982H</b> Price gr. <b>C517</b> (pce.)	<b>435986H</b> Price gr. <b>C474</b> (pce.)		<b>435994H</b> Price gr. <b>C440</b> (pce.)	
beige		<b>435978H</b> Price gr. <b>C152</b> (m <sup>2</sup> )			<b>435990H</b> Price gr. <b>C474</b> (pce.)		<b>435998H</b> Price gr. <b>C440</b> (pce.)
anthracite	<b>435975H</b> Price gr. <b>C149</b> (m <sup>2</sup> )		<b>435983H</b> Price gr. <b>C517</b> (pce.)	<b>435987H</b> Price gr. <b>C474</b> (pce.)		<b>435995H</b> Price gr. <b>C440</b> (pce.)	
anthracite		<b>435979H</b> Price gr. <b>C152</b> (m <sup>2</sup> )			<b>435991H</b> Price gr. <b>C474</b> (pce.)		<b>435999H</b> Price gr. <b>C440</b> (pce.)



<sup>3</sup> High weight only to carry with two persons.

<sup>4</sup> Please note: special pallet. No return, no exchange.

Rendering

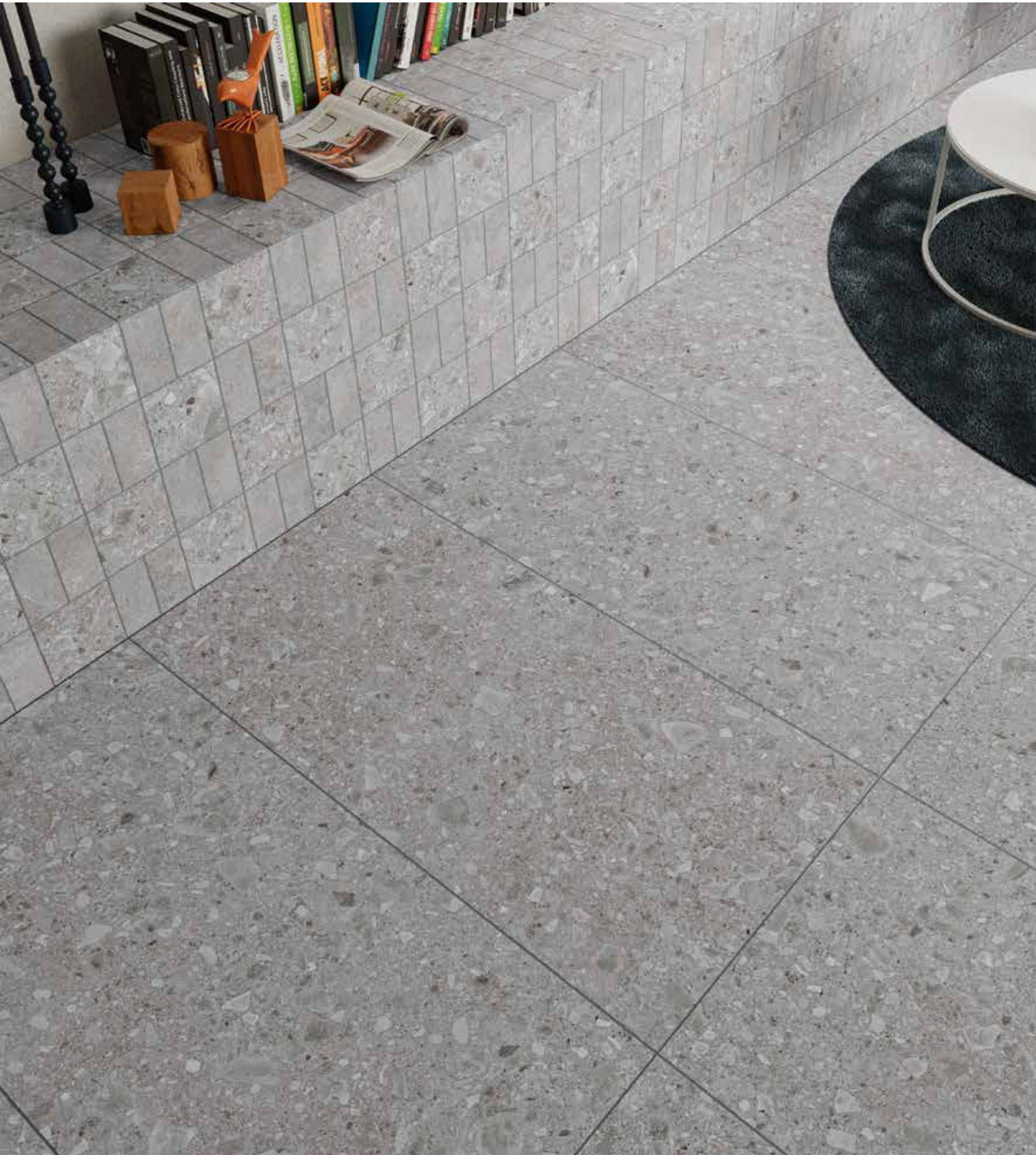





## When rooms tell stories

The series Stories is urban to the core: with its cement-like look, timeless grey shades, countless creative options and fascinating opulence. The intentional combination of components of the series reflects the residents' individual preferences: rooms literally tell stories. The floor tiles are convincing thanks to their soft nuances and unadulterated, stone-matt cement characteristics, thus creating an appealingly urban flair. What also makes the series Stories interesting is its two decoration variants: the Tangram cut decor and the Ivy full decor.

Rendering



Wall tile 30 x 60 cm, 12 x 24 in, pearl, structured



Wall tile 30 x 60 cm, 12 x 24 in, soft grey, structured



Wall tile 35 x 100 cm, 14 x 40 in, pearl, structured



Wall tile 35 x 100 cm, 14 x 40 in, soft grey, structured



## Decoration elements



Decorative tile Ivy 30 x 60 cm, 12 x 24 in, soft sepia, structured



Decorative tile Ivy 30 x 60 cm, 12 x 24 in, soft concrete, structured



Decorative tile Ivy 35 x 100 cm, 14 x 40 in, soft sepia, structured



Decorative tile Ivy 35 x 100 cm, 14 x 40 in, soft concrete, structured

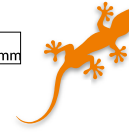

### Decoration elements



Mosaic sheet Tangram 30 x 30 cm  
12 x 12 in, ivory, structured, R10/A



Mosaic sheet Tangram 30 x 30 cm  
12 x 12 in, concrete, structured, R10/A



Mosaic sheet Tangram 30 x 30 cm,  
12 x 12 in, sepia, structured, R10/A

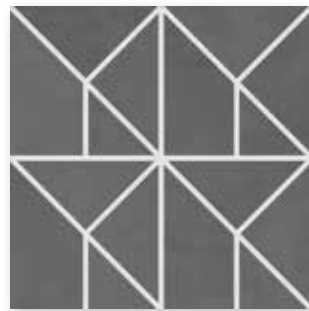

Mosaic sheet Tangram 30 x 30 cm,  
12 x 12 in, anthracite, structured, R10/A

Mosaic: glass fibre net on reverse side,  
sheet: 297 x 297 mm



R10/A



ivory



concrete

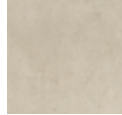

sepia



anthracite



Floor tile 30 x 60 cm, 12 x 24 in, structured, R10/A



Floor tile 60 x 60 cm, 24 x 24 in, structured, R10/A

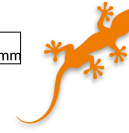

R10/A



ivory



concrete



sepia



anthracite

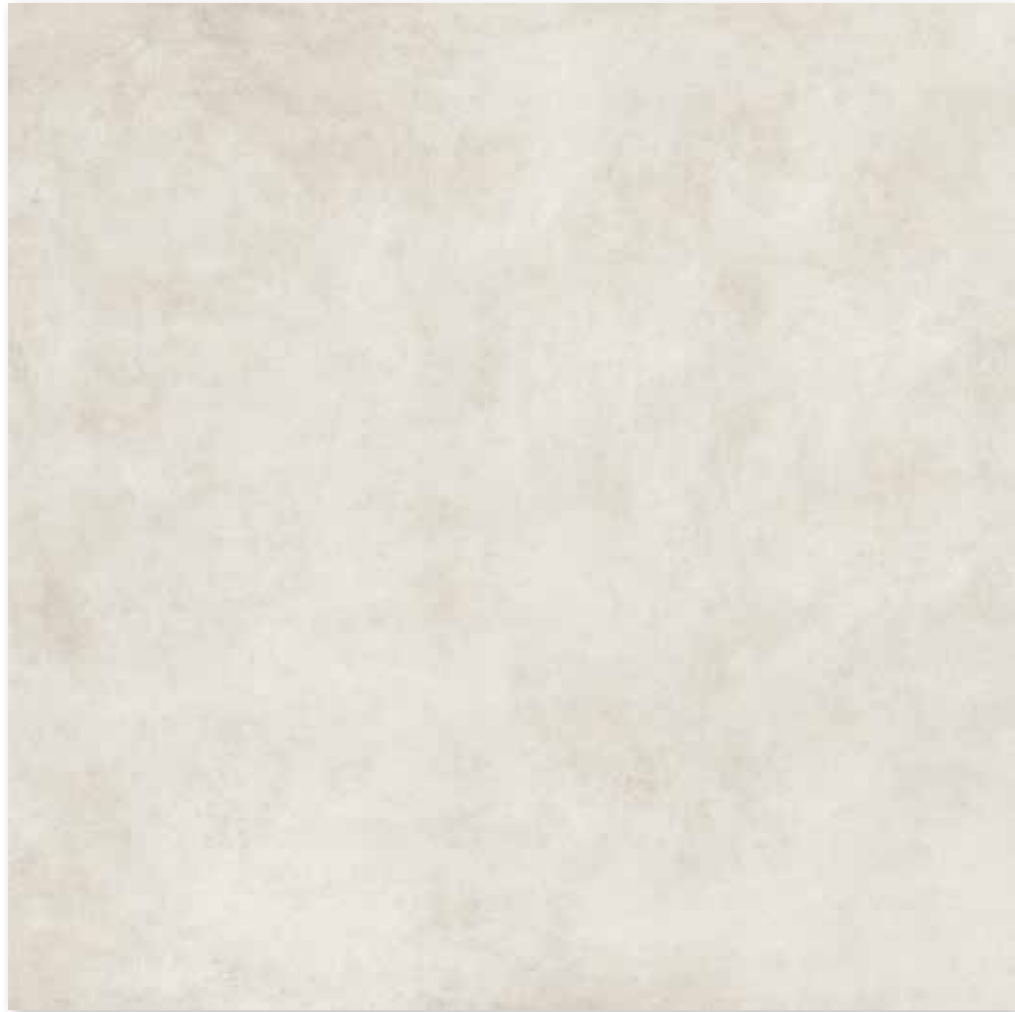

Floor tile 100 x 100 cm, 40 x 40 in, structured, R10/A



Stair tile 30 x 60 cm, 12 x 24 in (with grooves), structured, R10/A



Skirting, rounded 7 x 60 cm, 2 13/16 x 24 in, structured

### Mosaic 5 x 5 cm, 2 x 2 in



Mosaic sheet 30 x 30 cm, 12 x 12 in ivory, structured, R10/B



Mosaic sheet 30 x 30 cm, 12 x 12 in concrete, structured, R10/B



Mosaic sheet 30 x 30 cm, 12 x 12 in sepia, structured, R10/B

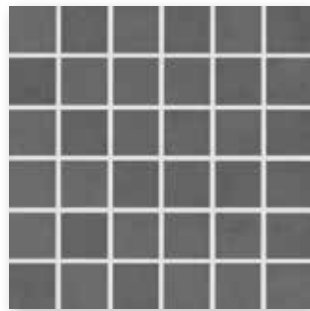

Mosaic sheet 30 x 30 cm, 12 x 12 in anthracite, structured, R10/B



Mosaics glued thermoplastically on back of Agrob Buchtal can be used not only in dry zones but also without any problems in underwater areas (e.g. swimming pools/whirlpools) as well as in permanently wet areas (e.g. pool surrounds/showers).

### Patio tiles



ivory



concrete

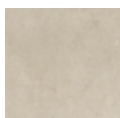

sepia



anthracite



Patio tile 60 x 60 cm, 24 x 24 in, structured, R11/B

Wall Tiles

Decoration Elements<sup>7</sup>

Mosaic<sup>3/4</sup>

30 x 60 cm



35 x 100 cm<sup>2</sup>



30 x 60 cm



35 x 100 cm<sup>2</sup>



30 x 30 cm<sup>1/3/5/6</sup>



5 x 5 cm



	Decorative tile Ivy		Decorative tile Ivy		Mosaic sheet Tangram	
	30 x 60 / 12 x 24	35 x 100 / 14 x 40	30 x 60 / 12 x 24	35 x 100 / 14 x 40	30 x 30 / 12 x 12	5 x 5 / 2 x 2
Nom. dim. - cm/in	297 x 597 x 6 mm	347 x 997 x 6 mm	297 x 597 x 6 mm	347 x 997 x 6 mm	297 x 297 x 6 mm	47 x 47 x 6.5 mm
Work size	297 x 597 x 6 mm	347 x 997 x 6 mm	297 x 597 x 6 mm	347 x 997 x 6 mm	297 x 297 x 6 mm	47 x 47 x 6.5 mm
Surface	structured, stone-matt	structured, stone-matt	structured, stone-matt	structured, stone-matt	structured, matt	structured, matt
m <sup>2</sup> /m - pieces	5.556/m <sup>2</sup>	2.857/m <sup>2</sup>	5.556/m <sup>2</sup>	2.857/m <sup>2</sup>	3.333 sheets/m	11 sheets/m <sup>2</sup>
m <sup>2</sup> /m - kg	10.279/m <sup>2</sup>	10.108/m <sup>2</sup>	10.279/m <sup>2</sup>	10.108/m <sup>2</sup>	3.776/m	12.331/m <sup>2</sup>
Bundle - pieces	13	5	13	5	3 sheets	11 sheets
Bundle - m <sup>2</sup> /m	2.340 m <sup>2</sup>	1.750 m <sup>2</sup>	2.340 m <sup>2</sup>	1.750 m <sup>2</sup>	0.900 m	1.000 m <sup>2</sup>
Bundle - kg	24.050	17.690	24.050	17.690	3.399	12.331
Pallet - m <sup>2</sup>	112.311	70.004	112.311	70.004		64.000
Pallet - kg	1,154.400	707.600	1,154.400	707.600		789.184
Product standard	BIII	BIII	BIII	BIII	Bla	Bla
Slip resistance					R10/A	R10/B
Stress group					1	1
pearl <input type="checkbox"/> V2	<b>203431H</b> Price gr. <b>W90</b> (m <sup>2</sup> )	<b>363352H</b> Price gr. <b>W132</b> (m <sup>2</sup> )				
soft grey <input type="checkbox"/> V2	<b>203433H</b> Price gr. <b>W90</b> (m <sup>2</sup> )	<b>363353H</b> Price gr. <b>W132</b> (m <sup>2</sup> )				
soft sepia <input type="checkbox"/> V3			<b>203432H</b> Price gr. <b>W102</b> (m <sup>2</sup> )	<b>363354H</b> Price gr. <b>W144</b> (m <sup>2</sup> )		
soft concrete <input type="checkbox"/> V3			<b>203434H</b> Price gr. <b>W102</b> (m <sup>2</sup> )	<b>363355H</b> Price gr. <b>W144</b> (m <sup>2</sup> )		
ivory <input type="checkbox"/> V2					<b>363356</b> Price gr. <b>W501</b> (pce.)	<b>432335H</b> Price gr. <b>W177</b> (m <sup>2</sup> )
concrete <input type="checkbox"/> V2					<b>363357</b> Price gr. <b>W501</b> (pce.)	<b>432336H</b> Price gr. <b>W177</b> (m <sup>2</sup> )
sepia <input type="checkbox"/> V2					<b>363358</b> Price gr. <b>W501</b> (pce.)	<b>432337H</b> Price gr. <b>W177</b> (m <sup>2</sup> )
anthracite <input type="checkbox"/> V2					<b>363359</b> Price gr. <b>W501</b> (pce.)	<b>432338H</b> Price gr. <b>W177</b> (m <sup>2</sup> )

- 1
- 2
- 3
- 4
- 5 without Hytect coating; with Protecta upgrading
- 6 Glass fibre net on reverse side
- 7 Decoration elements only available in full boxes.

### Floor Tiles<sup>1</sup>

30 x 60 cm



60 x 60 cm

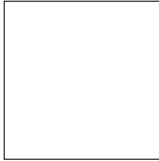

100 x 100 cm<sup>3/4/5/6</sup>

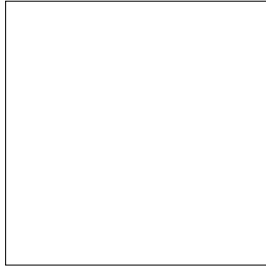

### Stair Tile<sup>1/2</sup>

30 x 60 cm



### Skirting, rounded<sup>1</sup>

7 x 60 cm



### Patio Tile<sup>1/5</sup>

60 x 60 cm

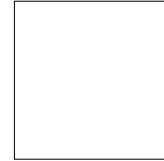

30 x 60 / 12 x 24	60 x 60 / 24 x 24	100 x 100 / 40 x 40		30 x 60 / 12 x 24	7 x 60 / 2 13/16 x 24	60 x 60 / 24 x 24	Nom. dim. - cm/in
297 x 597 x 9 mm	597 x 597 x 9 mm	997 x 997 x 6 mm		297 x 597 x 9 mm	70 x 597 x 9 mm	597 x 597 x 20 mm	Work size
structured, matt	structured, matt	structured, matt		structured, matt	structured, matt	structured, matt	Surface
5.556/m <sup>2</sup>	2.778/m <sup>2</sup>	1.000/m <sup>2</sup>		1.667/m	1.667/m	2.778/m <sup>2</sup>	m <sup>2</sup> /m - pieces
19.907/m <sup>2</sup>	20.371/m <sup>2</sup>	14.100/m <sup>2</sup>		5.973/m	1.357/m	45.273/m <sup>2</sup>	m <sup>2</sup> /m - kg
7	3	2		7	15	2	Bundle - pieces
1.260 m <sup>2</sup>	1.080 m <sup>2</sup>	2.000 m <sup>2</sup>		4.199 m	8.998 m	0.720 m <sup>2</sup>	Bundle - m <sup>2</sup> /m
25.081	21.999	28.200		25.081	12.210	32.594	Bundle - kg
50.396	45.356	50.000				21.598	Pallet - m <sup>2</sup>
1,003.240	923.958	705.000				977.820	Pallet - kg
Bla	Bla	Bla		Bla	Bla	Bla	Product standard
R10/A	R10/A	R10/A		R10/A	R10/A	R11/B	Slip resistance
2	2	1		2		4	Stress group
<b>431630H</b>	<b>431634H</b>	<b>432323</b>		<i>431638H</i>	<b>431642H</b>	<b>434986H</b>	ivory <input type="checkbox"/> V2
Price gr. <b>W111</b> (m <sup>2</sup> )	Price gr. <b>W123</b> (m <sup>2</sup> )	Price gr. <b>W156</b> (m <sup>2</sup> )		Price gr. <i>W473</i> (pce.)	Price gr. <b>W439</b> (pce.)	Price gr. <b>W198</b> (m <sup>2</sup> )	
<b>431632H</b>	<b>431636H</b>	<b>432324</b>		<i>431640H</i>	<b>431644H</b>	<b>434987H</b>	concrete <input type="checkbox"/> V2
Price gr. <b>W111</b> (m <sup>2</sup> )	Price gr. <b>W123</b> (m <sup>2</sup> )	Price gr. <b>W156</b> (m <sup>2</sup> )		Price gr. <i>W473</i> (pce.)	Price gr. <b>W439</b> (pce.)	Price gr. <b>W198</b> (m <sup>2</sup> )	
<b>431631H</b>	<b>431635H</b>	<b>432325</b>		<i>431639H</i>	<b>431643H</b>	<b>434988H</b>	sepia <input type="checkbox"/> V2
Price gr. <b>W111</b> (m <sup>2</sup> )	Price gr. <b>W123</b> (m <sup>2</sup> )	Price gr. <b>W156</b> (m <sup>2</sup> )		Price gr. <i>W473</i> (pce.)	Price gr. <b>W439</b> (pce.)	Price gr. <b>W198</b> (m <sup>2</sup> )	
<b>431633H</b>	<b>431637H</b>	<b>432326</b>		<i>431641H</i>	<b>431645H</b>	<b>434989H</b>	anthracite <input type="checkbox"/> V2
Price gr. <b>W111</b> (m <sup>2</sup> )	Price gr. <b>W123</b> (m <sup>2</sup> )	Price gr. <b>W156</b> (m <sup>2</sup> )		Price gr. <i>W473</i> (pce.)	Price gr. <b>W439</b> (pce.)	Price gr. <b>W198</b> (m <sup>2</sup> )	

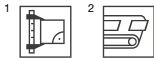

<sup>1</sup> without Hytect coating; with Protecta upgrading

<sup>2</sup> Please note: special pallet. No return, no exchange.

<sup>3</sup> High weight only to carry with two persons.

<sup>4</sup> Suitable for the use in areas with stress group 1.









## New naturalness

Strata reinterprets natural colors. The new ceramic series from Agrob Buchtal was developed together with the color designer Peter Zoernack. Following the example of nature, color shades were sought which correspond to a ceramic, stone material. The result is two color families with eight harmonious colors. With its nuanced color range, ceramic implementation and variety of formats, Strata offers architects and planners a useful modular system for timeless room designs. Technically sophisticated, it satisfies various practical requirements in indoor and outdoor areas.

Rendering / Architect: VSBL, Belgrad, Serbia



**R10/A+B**



quarz



Oblong format 10 x 60 cm, 4 x 24 in, smooth, R10/A+B



stone



Oblong format 15 x 60 cm, 6 x 24 in, smooth, R10/A+B



lava



volcano



Floor tile 30 x 60 cm, 12 x 24 in, smooth, R10/A+B  
Floor tile 30 x 60 cm, 12 x 24 in, smooth, R11/B



loam



clay



Floor tile 30 x 30 cm, 12 x 12 in, smooth, R10/A+B



lime



Floor tile 60 x 60 cm, 24 x 24 in, smooth, R10/A+B



pumice



Floor tile 60 x 120 cm, 24 x 48 in, smooth, R10/A+B



Stair tile (with grooves) 30 x 60 cm, 12 x 24 in, smooth, R10/A+B



Stair tile (with grooves) 60 x 120 cm, 24 x 48 in, smooth, R10/A+B



quarz



Skirting, rounded 7 x 60 cm, 2 13/16 x 24 in, smooth



stone



lava



Stair safety boarder 4 x 60 cm, 1 5/8 x 24 in, smooth, R10/A+B



volcano

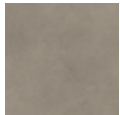

loam



Stair safety boarder 7.2 x 60 cm, 2 7/8 x 24 in, smooth, R10/A+B



clay



lime



Stair safety boarder 7.2 x 120 cm, 2 7/8 x 48 cm in, smooth, R10/A+B

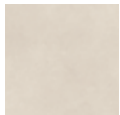

pumice



Stair safety boarder with bevel 7.2 x 145 cm, smooth, R10/A+B



Stair tile with bevel 31 x 145 cm, 12 13/64 x 57 in, smooth, R10/A+B

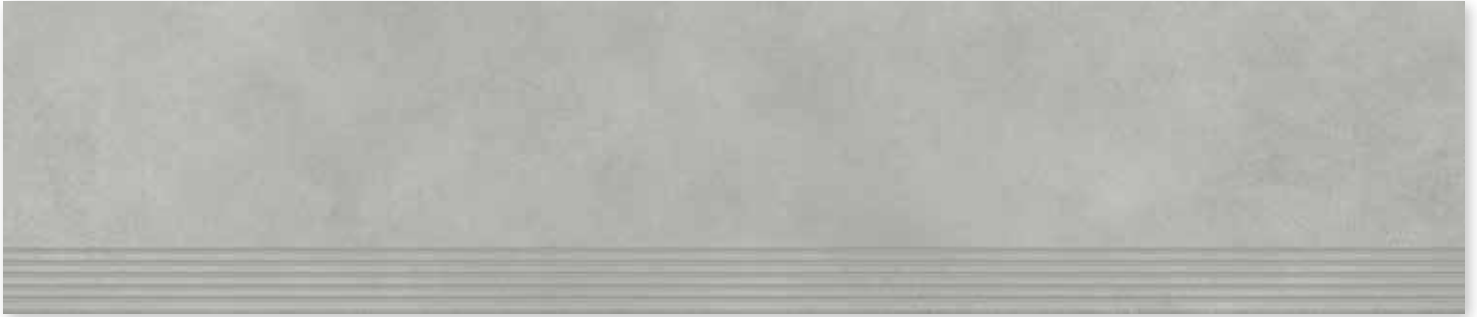

Stair tile with bevel and grooves 31 x 145 cm, 12 13/64 x 57 in, smooth, R10/A+B



Riser 28 x 145 cm, 11 x 57 in, smooth, R10/A+B



Cove skirting 10 x 30 cm, 4 x 12 in, smooth



Cove skirting 10 x 60 cm, 4 x 24 in, smooth

### Mosaic 5 x 5 cm, 2 x 2 in



Mosaic sheet 30 x 30 cm, 12 x 12 in quartz, smooth, R10/A+B

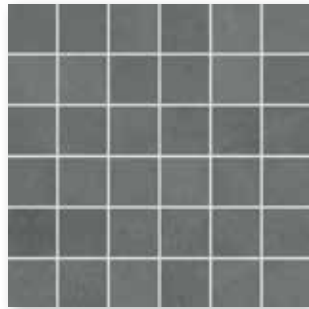

Mosaic sheet 30 x 30 cm, 12 x 12 in stone, smooth, R10/A+B

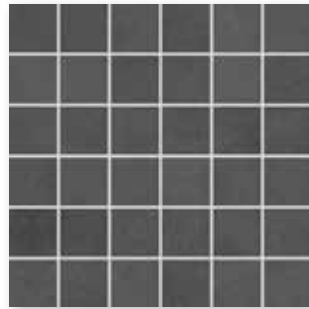

Mosaic sheet 30 x 30 cm, 12 x 12 in lava, smooth, R10/A+B

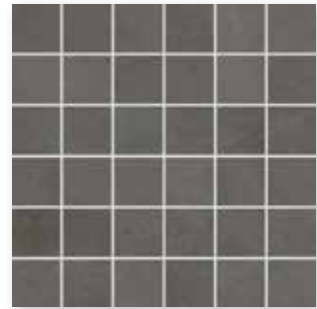

Mosaic sheet 30 x 30 cm, 12 x 12 in volcano, smooth, R10/A+B

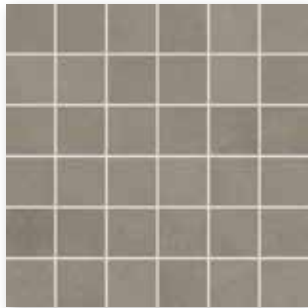

Mosaic sheet 30 x 30 cm, 12 x 12 in loam, smooth, R10/A+B

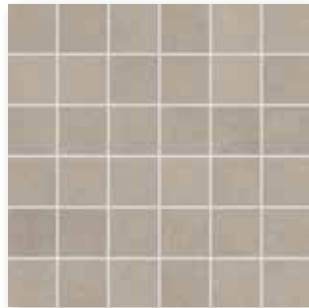

Mosaic sheet 30 x 30 cm, 12 x 12 in clay, smooth, R10/A+B



Mosaic sheet 30 x 30 cm, 12 x 12 in lime, smooth, R10/A+B

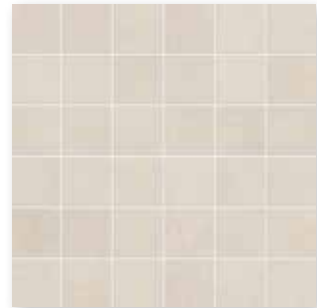

Mosaic sheet 30 x 30 cm, 12 x 12 in pumice, smooth, R10/A+B

### Mosaic sheet Edge 30 x 30 cm, 12 x 12 in



Mosaic sheet 30 x 30 cm, 12 x 12 in quartz, smooth, R10/A+B

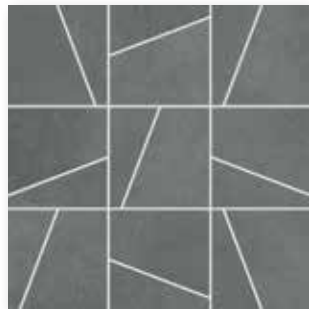

Mosaic sheet 30 x 30 cm, 12 x 12 in stone, smooth, R10/A+B

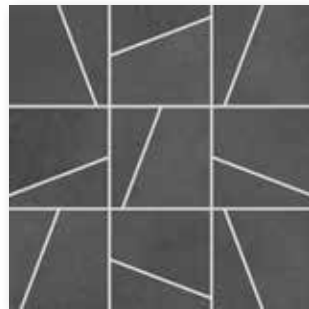

Mosaic sheet 30 x 30 cm, 12 x 12 in lava, smooth, R10/A+B

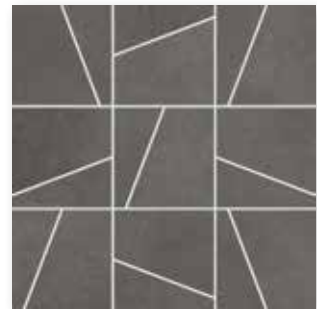

Mosaic sheet 30 x 30 cm, 12 x 12 in volcano, smooth, R10/A+B



Mosaic sheet 30 x 30 cm, 12 x 12 in loam, smooth, R10/A+B



Mosaic sheet 30 x 30 cm, 12 x 12 in clay, smooth, R10/A+B



Mosaic sheet 30 x 30 cm, 12 x 12 in lime, smooth, R10/A+B



Mosaic sheet 30 x 30 cm, 12 x 12 in pumice, smooth, R10/A+B

Mosaic: glass fibre net on reverse side, sheet: 297 x 297 mm

Mosaic<sup>1/3</sup>

Floor Tiles<sup>1</sup>

5 x 5 cm



10 x 10 cm



10 x 60 cm<sup>2</sup>



15 x 60 cm<sup>2</sup>



30 x 30 cm



30 x 60 cm



30 x 60 cm



Sheet: 297 x 297 mm

Mosaic Edge

Sheet: 297 x 297 mm

Oblong format

Oblong format

5 x 5 / 2 x 2	10 x 10 / 4 x 4	10 x 60 / 4 x 24	15 x 60 / 6 x 24	30 x 30 / 12 x 12	30 x 60 / 12 x 24	30 x 60 / 12 x 24	Nom. dim. - cm/in
47 x 47 x 8 mm	97 x 97 x 8 mm	97 x 597 x 8 mm	147 x 597 x 8 mm	297 x 297 x 8 mm	297 x 597 x 8 mm	297 x 597 x 8 mm	Work size
smooth, matt	smooth, matt	smooth, matt	smooth, matt	smooth, matt	smooth, matt	smooth, matt	Surface
11.111 sheets/m <sup>2</sup>	3.333 sheets/m	16.667/m <sup>2</sup>	11.111/m <sup>2</sup>	11.111/m <sup>2</sup>	5.556/m <sup>2</sup>	5.556/m <sup>2</sup>	m <sup>2</sup> - pieces
16.389/m <sup>2</sup>	4.823/m	17.417/m <sup>2</sup>	17.411/m <sup>2</sup>	17.222/m <sup>2</sup>	17.696/m <sup>2</sup>	17.696/m <sup>2</sup>	m <sup>2</sup> - kg
14 sheets	3 sheets	18	14	14	7	7	Bundle - pieces
1.260 m <sup>2</sup>	0.900 m	1.080 m <sup>2</sup>	1.260 m <sup>2</sup>	1.260 m <sup>2</sup>	1.260 m <sup>2</sup>	1.260 m <sup>2</sup>	Bundle - m <sup>2</sup> /m
20.650	4.341	18.810	21.938	21.708	22.295	22.295	Bundle - kg
37.800		43.199	50.401	60.481	50.396	50.396	Pallet - m <sup>2</sup>
619.500			877.520	1,041.600	891.800	891.800	Pallet - kg
Bla	Bla	Bla	Bla	Bla	Bla	Bla	Product standard
R10/A+B	R10/A+B	R10/A+B	R10/A+B	R10/A+B	R10/A+B	R11/B	Slip resistance
2	2		2	2	2	2	Stress group
<b>435380H</b>	<b>435372H</b>	<i>435397H</i>	<i>435409H</i>	<b>435417H</b>	<b>435428H</b>	<b>435301H</b>	quartz <input type="checkbox"/> V2
Price gr. <b>A265</b> (m <sup>2</sup> )	Price gr. <b>A506</b> (pce.)	Price gr. <i>A199</i> (m <sup>2</sup> )	Price gr. <i>A199</i> (m <sup>2</sup> )	Price gr. <b>A61</b> (m <sup>2</sup> )	Price gr. <b>A115</b> (m <sup>2</sup> )	Price gr. <b>A115</b> (m <sup>2</sup> )	
<b>435381H</b>	<b>435373H</b>	<i>435398H</i>	<i>435410H</i>	<b>435418H</b>	<b>435429H</b>	<b>435302H</b>	stone <input type="checkbox"/> V2
Price gr. <b>A265</b> (m <sup>2</sup> )	Price gr. <b>A506</b> (pce.)	Price gr. <i>A199</i> (m <sup>2</sup> )	Price gr. <i>A199</i> (m <sup>2</sup> )	Price gr. <b>A61</b> (m <sup>2</sup> )	Price gr. <b>A115</b> (m <sup>2</sup> )	Price gr. <b>A115</b> (m <sup>2</sup> )	
<b>435382H</b>	<b>435374H</b>	<i>435399H</i>	<i>435411H</i>	<b>435419H</b>	<b>435430H</b>	<b>435303H</b>	lava <input type="checkbox"/> V2
Price gr. <b>A265</b> (m <sup>2</sup> )	Price gr. <b>A506</b> (pce.)	Price gr. <i>A199</i> (m <sup>2</sup> )	Price gr. <i>A199</i> (m <sup>2</sup> )	Price gr. <b>A61</b> (m <sup>2</sup> )	Price gr. <b>A115</b> (m <sup>2</sup> )	Price gr. <b>A115</b> (m <sup>2</sup> )	
<b>435383H</b>	<b>435375H</b>	<i>435400H</i>	<i>435412H</i>	<b>435420H</b>	<b>435431H</b>	<b>435304H</b>	volcano <input type="checkbox"/> V2
Price gr. <b>A265</b> (m <sup>2</sup> )	Price gr. <b>A506</b> (pce.)	Price gr. <i>A199</i> (m <sup>2</sup> )	Price gr. <i>A199</i> (m <sup>2</sup> )	Price gr. <b>A61</b> (m <sup>2</sup> )	Price gr. <b>A115</b> (m <sup>2</sup> )	Price gr. <b>A115</b> (m <sup>2</sup> )	
<b>435384H</b>	<b>435376H</b>	<i>435401H</i>	<i>435413H</i>	<b>435421H</b>	<b>435432H</b>	<b>435305H</b>	loam <input type="checkbox"/> V2
Price gr. <b>A265</b> (m <sup>2</sup> )	Price gr. <b>A506</b> (pce.)	Price gr. <i>A199</i> (m <sup>2</sup> )	Price gr. <i>A199</i> (m <sup>2</sup> )	Price gr. <b>A61</b> (m <sup>2</sup> )	Price gr. <b>A115</b> (m <sup>2</sup> )	Price gr. <b>A115</b> (m <sup>2</sup> )	
<b>435385H</b>	<b>435377H</b>	<i>435402H</i>	<i>435414H</i>	<b>435422H</b>	<b>435433H</b>	<b>435306H</b>	clay <input type="checkbox"/> V2
Price gr. <b>A265</b> (m <sup>2</sup> )	Price gr. <b>A506</b> (pce.)	Price gr. <i>A199</i> (m <sup>2</sup> )	Price gr. <i>A199</i> (m <sup>2</sup> )	Price gr. <b>A61</b> (m <sup>2</sup> )	Price gr. <b>A115</b> (m <sup>2</sup> )	Price gr. <b>A115</b> (m <sup>2</sup> )	
<b>435386H</b>	<b>435378H</b>	<i>435403H</i>	<i>435415H</i>	<b>435423H</b>	<b>435434H</b>	<b>435307H</b>	lime <input type="checkbox"/> V2
Price gr. <b>A265</b> (m <sup>2</sup> )	Price gr. <b>A506</b> (pce.)	Price gr. <i>A199</i> (m <sup>2</sup> )	Price gr. <i>A199</i> (m <sup>2</sup> )	Price gr. <b>A61</b> (m <sup>2</sup> )	Price gr. <b>A115</b> (m <sup>2</sup> )	Price gr. <b>A115</b> (m <sup>2</sup> )	
<b>435387H</b>	<b>435379H</b>	<i>435404H</i>	<i>435416H</i>	<b>435424H</b>	<b>435435H</b>	<b>435308H</b>	pumice <input type="checkbox"/> V2
Price gr. <b>A265</b> (m <sup>2</sup> )	Price gr. <b>A506</b> (pce.)	Price gr. <i>A199</i> (m <sup>2</sup> )	Price gr. <i>A199</i> (m <sup>2</sup> )	Price gr. <b>A61</b> (m <sup>2</sup> )	Price gr. <b>A115</b> (m <sup>2</sup> )	Price gr. <b>A115</b> (m <sup>2</sup> )	

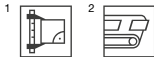

<sup>3</sup> Glass fibre net on reverse side



Floor Tiles<sup>1</sup>

Stair Tiles with grooves<sup>1/2</sup>

Stair Tile with bevel<sup>2/4/5</sup>

Stair Tile with bevel & grooves<sup>2/4/5</sup>

Riser<sup>2/4</sup>

60 x 60 cm

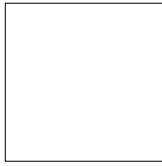

60 x 120 cm<sup>3</sup>

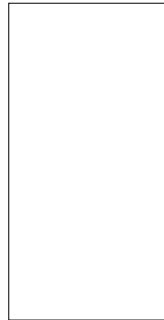

30 x 60 cm

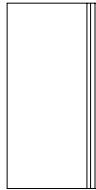

60 x 120 cm<sup>3</sup>

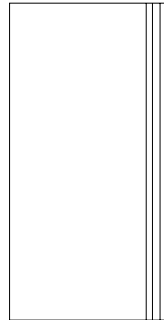

31 x 145 cm



31 x 145 cm

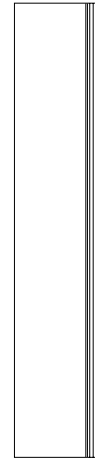

28 x 145 cm



Nom. dim. - cm/in	60 x 60 / 24 x 24	60 x 120 / 24 x 48	30 x 60 / 12 x 24	60 x 120 / 24 x 48	31 x 145 / 12 3/8 x 58	31 x 145 / 12 3/8 x 58	28 x 145 / 11 3/16 x 58
Work size	597 x 597 x 8 mm	597 x 1197 x 8 mm	297 x 597 x 8 mm	597 x 1197 x 8 mm	307 x 1447 x 10.5 mm	307 x 1447 x 10.5 mm	280 x 1447 x 10.5 mm
Surface	smooth, matt	smooth, matt	smooth, matt	smooth, matt	smooth, matt	smooth, matt	smooth, matt
m <sup>2</sup> /m - pieces	2,778/m <sup>2</sup>	1.388/m <sup>2</sup>	1.667/m	0.833/m	0.690/m	0.690/m	0.690/m
m <sup>2</sup> /m - kg	18.107/m <sup>2</sup>	18.784/m <sup>2</sup>	5.310/m	11.273/m	7.480/m	7.480/m	6.716/m
Bundle - pieces	4	2	7	2	2	2	2
Bundle - m <sup>2</sup> /m	1.440 m <sup>2</sup>	1.440 m <sup>2</sup>	4.200 m	2.401 m	2.899 m	2.899 m	2.899 m
Bundle - kg	26.072	27.066	22.295	27.066	21.682	21.682	19.466
Pallet - m <sup>2</sup>	51.836	50.432					
Pallet - kg	938.592	947.310					
Product standard	Bla	Bla	Bla	Bla	Ala	Ala	Ala
Slip resistance	R10/A+B	R10/A+B	R10/A+B	R10/A+B	R10/A+B	R10/A+B	R10/A+B
Stress group	2	2	2	2	2	2	2
quartz	<b>435436H</b> Price gr. <b>A127</b> (m <sup>2</sup> )	<b>435452H</b> Price gr. <b>A124</b> (m <sup>2</sup> )	435460H Price gr. A465 (pce.)	435452H-TF Price gr. A593 (pce.)	435468H Price gr. A560 (pce.)	435468H-TF Price gr. A577 (pce.)	435476H Price gr. A528 (pce.)
stone	<b>435437H</b> Price gr. <b>A127</b> (m <sup>2</sup> )	<b>435453H</b> Price gr. <b>A124</b> (m <sup>2</sup> )	435461H Price gr. A465 (pce.)	435453H-TF Price gr. A593 (pce.)	435469H Price gr. A560 (pce.)	435469H-TF Price gr. A577 (pce.)	435477H Price gr. A528 (pce.)
lava	<b>435438H</b> Price gr. <b>A127</b> (m <sup>2</sup> )	<b>435454H</b> Price gr. <b>A124</b> (m <sup>2</sup> )	435462H Price gr. A465 (pce.)	435454H-TF Price gr. A593 (pce.)	435470H Price gr. A560 (pce.)	435470H-TF Price gr. A577 (pce.)	435478H Price gr. A528 (pce.)
volcano	<b>435439H</b> Price gr. <b>A127</b> (m <sup>2</sup> )	<b>435455H</b> Price gr. <b>A124</b> (m <sup>2</sup> )	435463H Price gr. A465 (pce.)	435455H-TF Price gr. A593 (pce.)	435471H Price gr. A560 (pce.)	435471H-TF Price gr. A577 (pce.)	435479H Price gr. A528 (pce.)
loam	<b>435440H</b> Price gr. <b>A127</b> (m <sup>2</sup> )	<b>435456H</b> Price gr. <b>A124</b> (m <sup>2</sup> )	435464H Price gr. A465 (pce.)	435456H-TF Price gr. A593 (pce.)	435472H Price gr. A560 (pce.)	435472H-TF Price gr. A577 (pce.)	435480H Price gr. A528 (pce.)
clay	<b>435441H</b> Price gr. <b>A127</b> (m <sup>2</sup> )	<b>435457H</b> Price gr. <b>A124</b> (m <sup>2</sup> )	435465H Price gr. A465 (pce.)	435457H-TF Price gr. A593 (pce.)	435473H Price gr. A560 (pce.)	435473H-TF Price gr. A577 (pce.)	435481H Price gr. A528 (pce.)
lime	<b>435442H</b> Price gr. <b>A127</b> (m <sup>2</sup> )	<b>435458H</b> Price gr. <b>A124</b> (m <sup>2</sup> )	435466H Price gr. A465 (pce.)	435458H-TF Price gr. A593 (pce.)	435474H Price gr. A560 (pce.)	435474H-TF Price gr. A577 (pce.)	435482H Price gr. A528 (pce.)
pumice	<b>435443H</b> Price gr. <b>A127</b> (m <sup>2</sup> )	<b>435459H</b> Price gr. <b>A124</b> (m <sup>2</sup> )	435467H Price gr. A465 (pce.)	435459H-TF Price gr. A593 (pce.)	435475H Price gr. A560 (pce.)	435475H-TF Price gr. A577 (pce.)	435483H Price gr. A528 (pce.)



<sup>3</sup> High weight only to carry with two persons.  
<sup>4</sup> Only rectified on the two short sides. The long side can not be rectified.  
<sup>5</sup> For details, refer to page 538



### Stair Edges<sup>1/2</sup>

### Stair Edges with bevel<sup>2/3/4</sup>

4 x 60 cm



7,2 x 60 cm



7,2 x 120 cm



7,2 x 145 cm



			4 x 60 / 1 5/8 x 24	7.2 x 60 / 2 7/8 x 24	7.2 x 120 / 2 7/8 x 48	7.2 x 145 / 2 7/8 x 58	Nom. dim. - cm/in
			40 x 597 x 8 mm	72 x 597 x 8 mm	72 x 1197 x 8 mm	72 x 1447 x 10.5 mm	Work size
			smooth, matt	smooth, matt	smooth, matt	smooth, matt	Surface
			1.667	1.667	0.833	0.690	m - pieces
			0.697	1.254	1.353	1.737	m - kg
			9	18	10	10	Bundle - pieces
			5.399	10.7893	12.005	14.493	Bundle - m
			3.762	13.536	16.240	25.180	Bundle - kg
			Bla	Bla	Bla	Ala	Product standard
			R10/A+B	R10/A+B	R10/A+B	R10/A+B	Slip resistance
			2	2	2	2	Stress group
			435484H	435428H-TK	435452H-TK	435468H-TK	quartz <input type="checkbox"/> V2
			Price gr. A458 (pce.)	Price gr. A458 (pce.)	Price gr. A511 (pce.)	Price gr. A539 (pce.)	
			435485H	435429H-TK	435453H-TK	435469H-TK	stone <input type="checkbox"/> V2
			Price gr. A458 (pce.)	Price gr. A458 (pce.)	Price gr. A511 (pce.)	Price gr. A539 (pce.)	
			435486H	435430H	435454H-TK	435470H-TK	lava <input type="checkbox"/> V2
			Price gr. A458 (pce.)	Price gr. A458 (pce.)	Price gr. A511 (pce.)	Price gr. A539 (pce.)	
			435487H	435431H-TK	435455H-TK	435471H-TK	volcano <input type="checkbox"/> V2
			Price gr. A458 (pce.)	Price gr. A458 (pce.)	Price gr. A511 (pce.)	Price gr. A539 (pce.)	
			435488H	435432H-TK	435456H-TK	435472H-TK	loam <input type="checkbox"/> V2
			Price gr. A458 (pce.)	Price gr. A458 (pce.)	Price gr. A511 (pce.)	Price gr. A539 (pce.)	
			435489H	435433H-TK	435457H-TK	435473H-TK	clay <input type="checkbox"/> V2
			Price gr. A458 (pce.)	Price gr. A458 (pce.)	Price gr. A511 (pce.)	Price gr. A539 (pce.)	
			435490H	435434H-TK	435458H-TK	435474H-TK	lime <input type="checkbox"/> V2
			Price gr. A458 (pce.)	Price gr. A458 (pce.)	Price gr. A511 (pce.)	Price gr. A539 (pce.)	
			435491H	435435H-TK	435459H-TK	435475H-TK	pumice <input type="checkbox"/> V2
			Price gr. A458 (pce.)	Price gr. A458 (pce.)	Price gr. A511 (pce.)	Price gr. A539 (pce.)	



<sup>3</sup> Rectified only on the two short sides. The long side can not be rectified.

<sup>4</sup> For details, refer to page 538



**Skirting, rounded<sup>1</sup>**

**Cove Skirting<sup>2</sup>**

7 x 60 cm

10 x 30 cm

10 x 60 cm



Nom. dim. - cm/in	7 x 60 / 2 13/16 x 24	10 x 30 / 4 x 12	10 x 60 / 4 x 24				
Work size	70 x 597 x 8 mm	102 x 297 x 9 mm	102 x 597 x 9 mm				
Surface	smooth, matt	smooth, matt	smooth, matt				
m - pieces	1.667	3.333	1.667				
m - kg	1.207	1.776	2.000				
Bundle - pieces	15	16	16				
Bundle - m	8.998	4.800	9.598				
Bundle - kg	10.860	8.528	17.072				
Pallet - m <sup>2</sup>							
Pallet - kg							
Product standard	Bla	Bla	Bla				
Slip resistance		R10/A+B	R10/A+B				
Stress group							
quartz <input type="checkbox"/>	<b>435492H</b> Price gr. <b>A425</b> (pce.)	<b>435309H</b> Price gr. <b>A422</b> (pce.)	<b>435317H</b> Price gr. <b>A441</b> (pce.)				
stone <input type="checkbox"/>	<b>435493H</b> Price gr. <b>A425</b> (pce.)	<b>435310H</b> Price gr. <b>A422</b> (pce.)	<b>435318H</b> Price gr. <b>A441</b> (pce.)				
lava <input type="checkbox"/>	<b>435494H</b> Price gr. <b>A425</b> (pce.)	<b>435311H</b> Price gr. <b>A422</b> (pce.)	<b>435319H</b> Price gr. <b>A441</b> (pce.)				
volcano <input type="checkbox"/>	<b>435495H</b> Price gr. <b>A425</b> (pce.)	<b>435312H</b> Price gr. <b>A422</b> (pce.)	<b>435320H</b> Price gr. <b>A441</b> (pce.)				
loam <input type="checkbox"/>	<b>435496H</b> Price gr. <b>A425</b> (pce.)	<b>435313H</b> Price gr. <b>A422</b> (pce.)	<b>435321H</b> Price gr. <b>A441</b> (pce.)				
clay <input type="checkbox"/>	<b>435497H</b> Price gr. <b>A425</b> (pce.)	<b>435314H</b> Price gr. <b>A422</b> (pce.)	<b>435322H</b> Price gr. <b>A441</b> (pce.)				
lime <input type="checkbox"/>	<b>435498H</b> Price gr. <b>A425</b> (pce.)	<b>435315H</b> Price gr. <b>A422</b> (pce.)	<b>435323H</b> Price gr. <b>A441</b> (pce.)				
pumice <input type="checkbox"/>	<b>435499H</b> Price gr. <b>A425</b> (pce.)	<b>435316H</b> Price gr. <b>A422</b> (pce.)	<b>435324H</b> Price gr. <b>A441</b> (pce.)				



<sup>2</sup> Color deviations compared to the adjoining covering due to production are no reason for complaint in case of horizontal laying.

Rendering







## Urban, casual, cool

Streetlife Metallic translates the good feeling of lived-in surfaces into an expressive tile design. The protagonists of the series: rust surfaces with streaks, traces of oxidation and radiant vibrancy. In addition, a soft, cloudy, iridescent look reminiscent of brushed metal surfaces. In Streetlife Metallic, the two form a powerful combination which lends a timeless urban feel to open-plan living concepts and modern loft architecture. Intense, metallic colors provide a stage especially for real wood, shimmering fabrics and metal elements. With formats of 60 x 60 and 60 x 120 cm and a thickness of 10.5 mm, this timeless floor covering also qualifies for public applications such as e.g. office spaces or retail design.

Rendering



rust

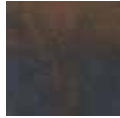

rust blue

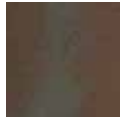

rust green

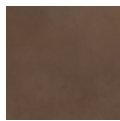

terra

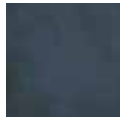

blue steel

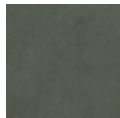

rusty green



Floor tile 60 x 60 cm, 24 x 24 in, structured, R10



Floor tile 60 x 120 cm, 24 x 48 in, structured, R10



Stair tile 30 x 120 cm, 12 x 48 in (with grooves), structured, R10



Skirting, cut 6 x 60 cm, 2 3/8 x 24 in, structured

Floor Tiles<sup>1</sup>

Stair Tile<sup>1/2</sup>

Skirting, cut<sup>1</sup>

60 x 60 cm

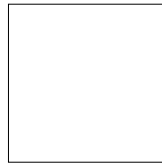

60 x 120 cm<sup>3</sup>

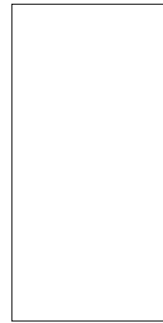

30 x 120 cm



6 x 60 cm



	B700HK	B770HK	B729HK	B710HK	
	<b>60 x 60</b> / 24 x 24	<b>60 x 120</b> / 24 x 48	<b>30 x 120</b> / 12 x 48	<b>6 x 60</b> / 2 3/8 x 24	Model number
	597 x 597 x 10.5 mm	597 x 1197 x 10.5 mm	297 x 1197 x 10.5 mm	60 x 597 x 10.5 mm	Nom. dim. - cm/in
	structured, matt	structured, matt	structured, matt	structured, matt	Work size
	2.778/m <sup>2</sup>	1.389/m <sup>2</sup>	0.833/m	1.667/m	Surface
	23.335/m <sup>2</sup>	23.821/m <sup>2</sup>	6.427/m	1.445/m	m <sup>2</sup> /m - pieces
	3	2	3	24	m <sup>2</sup> /m - kg
	1.080 m <sup>2</sup>	1.440 m <sup>2</sup>	3.601 m	14.397 m	Bundle - pieces
	25.200	34.300	23.148	20.808	Bundle - m <sup>2</sup> /m
	32.397	30.259			Bundle - kg
	756.000	720.300			Pallet - m <sup>2</sup>
	Ala	Ala	Ala	Ala	Pallet - kg
	R10/A+B	R10/A+B	R10/A+B		Product standard
	2	2	2	2	Slip resistance
	<b>8823-B700HK</b>	<b>8823-B770HK</b>	<i>8823-B729HK</i>	<b>8823-B710HK</b>	Stress group
	Price gr. <b>A154</b> (m <sup>2</sup> )	Price gr. <b>A178</b> (m <sup>2</sup> )	Price gr. <i>A560</i> (pce.)	Price gr. <b>A438</b> (pce.)	rust <input type="checkbox"/> V4
	<b>8824-B700HK</b>	<b>8824-B770HK</b>	<i>8824-B729HK</i>	<b>8824-B710HK</b>	rust-blue <input type="checkbox"/> V4
	Price gr. <b>A154</b> (m <sup>2</sup> )	Price gr. <b>A178</b> (m <sup>2</sup> )	Price gr. <i>A560</i> (pce.)	Price gr. <b>A438</b> (pce.)	rust-green <input type="checkbox"/> V4
	<b>8825-B700HK</b>	<b>8825-B770HK</b>	<i>8825-B729HK</i>	<b>8825-B710HK</b>	terra <input type="checkbox"/> V2
	Price gr. <b>A154</b> (m <sup>2</sup> )	Price gr. <b>A178</b> (m <sup>2</sup> )	Price gr. <i>A560</i> (pce.)	Price gr. <b>A438</b> (pce.)	blue steel <input type="checkbox"/> V2
	<b>8826-B700HK</b>	<b>8826-B770HK</b>	<i>8826-B729HK</i>	<b>8826-B710HK</b>	cooper green <input type="checkbox"/> V2
	Price gr. <b>A154</b> (m <sup>2</sup> )	Price gr. <b>A178</b> (m <sup>2</sup> )	Price gr. <i>A560</i> (pce.)	Price gr. <b>A438</b> (pce.)	
	<b>8827-B700HK</b>	<b>8827-B770HK</b>	<i>8827-B729HK</i>	<b>8827-B710HK</b>	
	Price gr. <b>A154</b> (m <sup>2</sup> )	Price gr. <b>A178</b> (m <sup>2</sup> )	Price gr. <i>A560</i> (pce.)	Price gr. <b>A438</b> (pce.)	
	<b>8828-B700HK</b>	<b>8828-B770HK</b>	<i>8828-B729HK</i>	<b>8828-B710HK</b>	
	Price gr. <b>A154</b> (m <sup>2</sup> )	Price gr. <b>A178</b> (m <sup>2</sup> )	Price gr. <i>A560</i> (pce.)	Price gr. <b>A438</b> (pce.)	

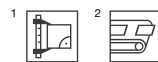

<sup>3</sup> High weight only to carry with two persons.



Available as of the 2nd quarter of 2025 (exception: the articles in the color rust).





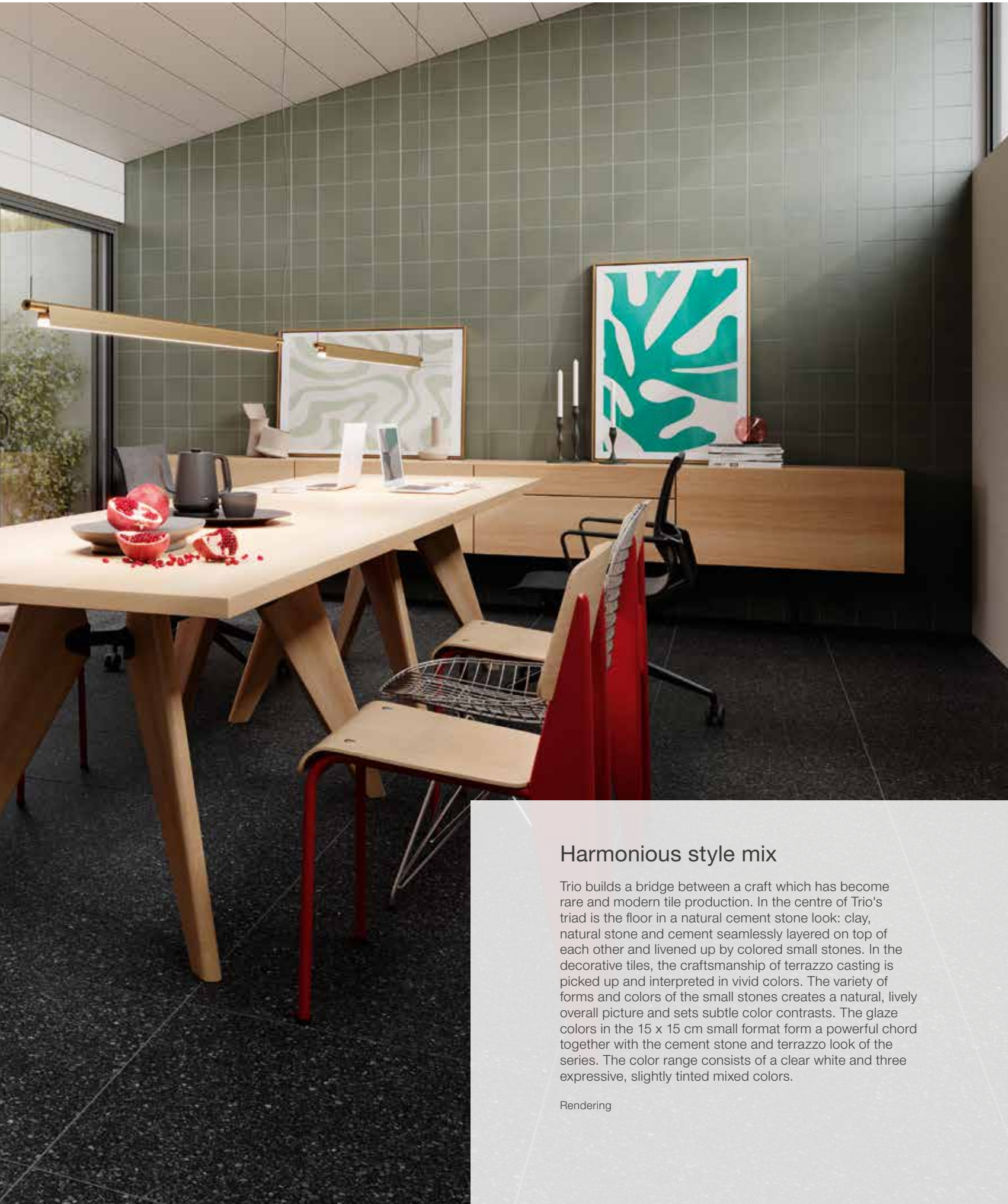

## Harmonious style mix

Trio builds a bridge between a craft which has become rare and modern tile production. In the centre of Trio's triad is the floor in a natural cement stone look: clay, natural stone and cement seamlessly layered on top of each other and livened up by colored small stones. In the decorative tiles, the craftsmanship of terrazzo casting is picked up and interpreted in vivid colors. The variety of forms and colors of the small stones creates a natural, lively overall picture and sets subtle color contrasts. The glaze colors in the 15 x 15 cm small format form a powerful chord together with the cement stone and terrazzo look of the series. The color range consists of a clear white and three expressive, slightly tinted mixed colors.

Rendering

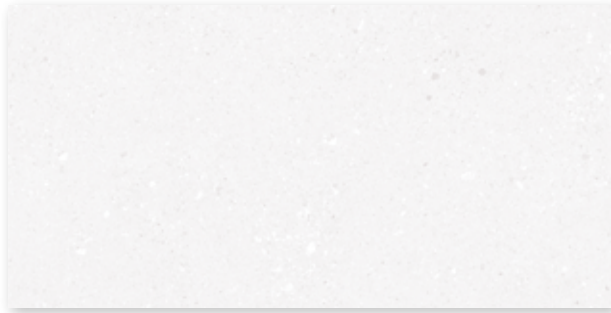

Wall tile 30 x 60 cm, 12 x 24 in, silk white, structured

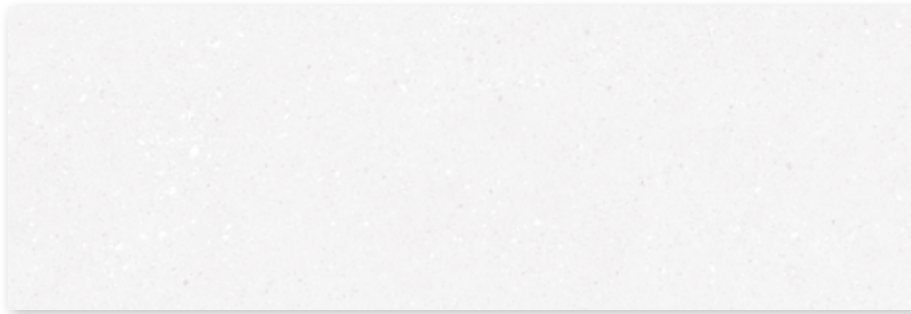

Wall tile 30 x 90 cm, 12 x 36 in, silk white, structured

## Decoration elements



Decorative tile Terrazzo 30 x 60 cm, 12 x 24 in, beige mix, structured



Decorative tile Terrazzo 30 x 90 cm, beige mix, structured

### Decoration elements



Decorative tile Color  
15 x 15 cm, 6 x 6 in, brick,  
smooth



Decorative tile Color  
15 x 15 cm, 6 x 6 in, olive,  
smooth



Decorative tile Color  
15 x 15 cm, 6 x 6 in, aqua,  
smooth

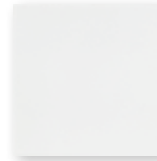

Decorative tile Color  
15 x 15 cm, 6 x 6 in, platin,  
smooth



Decorative tile Lines  
15 x 15 cm, 6 x 6 in, brick,  
relief



Decorative tile Lines  
15 x 15 cm, 6 x 6 in, olive,  
relief



Decorative tile Lines  
15 x 15 cm, 6 x 6 in, aqua,  
relief

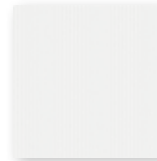

Decorative tile Lines  
15 x 15 cm, 6 x 6 in, platin,  
relief

### Mosaic 5 x 5 cm, 2 x 2 in



Mosaic sheet 30 x 30 cm, 12 x 12 in,  
ivory white, structured, R10/A+B

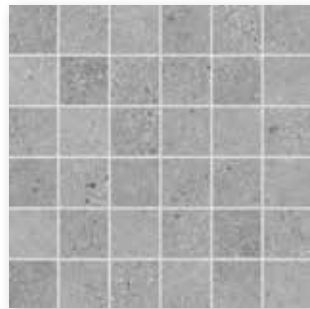

Mosaic sheet 30 x 30 cm, 12 x 12 in,  
cement grey, structured, R10/A+B

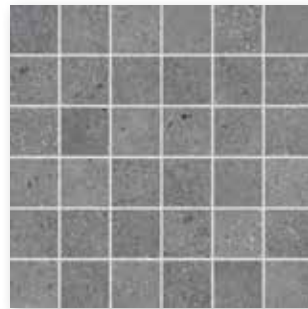

Mosaic sheet 30 x 30 cm, 12 x 12 in,  
iron grey, structured, R10/A+B

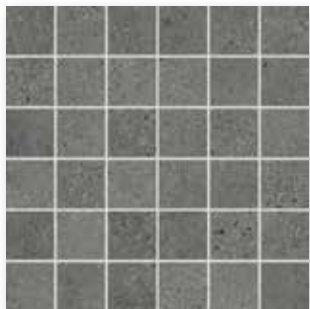

Mosaic sheet 30 x 30 cm, 12 x 12 in,  
mud grey, structured, R10/A+B

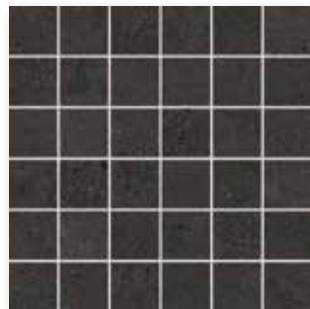

Mosaic sheet 30 x 30 cm, 12 x 12 in,  
slate black, structured, R10/A+B

Mosaic: glass fibre net on reverse side,  
sheet: 297 x 297 mm



ivory white



cement grey



iron grey



mud grey

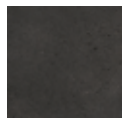

slate black



Floor tile 30 x 60 cm, 12 x 24 in, structured, R10/A+B



Floor tile 60 x 60 cm, 24 x 24 in, structured, R10/A+B



Floor tile 60 x 120 cm, 24 x 48 in, structured, R10/A+B



Stair tile 30 x 60 cm, 12 x 24 in (with grooves), structured, R10/A+B



Stair tile 30 x 120 cm, 12 x 48 in (with grooves), structured, R10/A+B

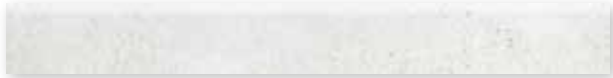

Skirting, rounded 7 x 60 cm, 2 13/16 x 24 in, structured



Patio tile 60 x 60 cm, 24 x 24 in, ivory white, structured, R11/B

without illustration:  
 Patio tile 120 x 120 cm, 48 x 48 in, cement grey, structured, R11/B  
 Patio tile 120 x 120 cm, 48 x 48 in, slate black, structured, R11/B

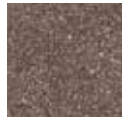

terrazzo red



terrazzo black



terrazzo ivory



Floor tile Terrazzo 60 x 60 cm, 24 x 24 in, structured, R10/A+B



Floor tile Terrazzo 60 x 120 cm, 24 x 48 in, structured, R10/A+B



Stair tile Terrazzo 30 x 120 cm, 12 x 48 in, (with grooves), structured, R10/A+B

Wall Tiles

Decoration Elements<sup>4</sup>

30 x 60 m<sup>1</sup>



30 x 90 cm<sup>3</sup>



30 x 60 cm

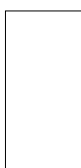

30 x 90 cm<sup>3</sup>



15 x 15 cm<sup>2</sup>



15 x 15 cm<sup>2</sup>



	Decorative tile Terrazzo	Decorative tile Terrazzo	Decorative tile Color	Decorative tile Lines			
	<b>30 x 60 / 12 x 24</b>	<b>30 x 90 / 12 x 36</b>	<b>30 x 60 / 12 x 24</b>	<b>30 x 90 / 12 x 36</b>	<b>15 x 15 / 6 x 6</b>	<b>15 x 15 / 6 x 6</b>	Nom. dim. - cm/in
	297 x 597 x 6 mm	297 x 897 x 6 mm	297 x 597 x 6 mm	297 x 897 x 6 mm	147 x 147 x 6.5 mm	147 x 147 x 6.5 mm	Work size
	structured, stone-matt	structured, stone-matt	structured, stone-matt	structured, stone-matt	smooth, matt	relief, glossy	Surface
	5.556	3.704	5.556	3.704	44.444	44.444	m <sup>2</sup> - pieces
	10.279	10.400	10.279	10.400	13.955	13.955	m <sup>2</sup> - kg
	13	8	13	8	44	44	Bundle - pieces
	2.340	2.160	2.340	2.160	0.990	0.990	Bundle - m <sup>2</sup>
	24.050	22.464	24.050	22.464	13.816	13.816	Bundle - kg
	112.311	51.836	112.311	51.836	79.201	79.201	Pallet - m <sup>2</sup>
	1,154.400	539.136	1,154.400	539.136	1,105.280	1,105.280	Pallet - kg
	BIII	BIII	BIII	BIII	Bla (GL)	Bla (GL)	Product standard
							Slip resistance
					1		Stress group
	<b>203416H</b>	<b>323418H</b>					silk white <input type="checkbox"/> V1
	Price gr. C107 (m <sup>2</sup> )	Price gr. C149 (m <sup>2</sup> )					beige mix <input type="checkbox"/> V4
			<b>203417H</b>	<b>323419H</b>	<b>133420H</b>		1 brick <input type="checkbox"/> V1
			Price gr. C116 (m <sup>2</sup> )	Price gr. C155 (m <sup>2</sup> )	Price gr. C152 (m <sup>2</sup> )	<b>133424H</b>	2 brick <input type="checkbox"/> V2
						Price gr. C152 (m <sup>2</sup> )	olive <input type="checkbox"/> V1
					<b>133421H</b>		olive <input type="checkbox"/> V2
					Price gr. C152 (m <sup>2</sup> )	<b>133425H</b>	aqua <input type="checkbox"/> V1
						Price gr. C152 (m <sup>2</sup> )	aqua <input type="checkbox"/> V2
					<b>133422H</b>		platinum <input type="checkbox"/> V1
					Price gr. C152 (m <sup>2</sup> )	<b>133426H</b>	platinum <input type="checkbox"/> V2
						Price gr. C152 (m <sup>2</sup> )	
					<b>133423H</b>		
					Price gr. C152 (m <sup>2</sup> )	<b>133427H</b>	
						Price gr. C152 (m <sup>2</sup> )	



<sup>4</sup> Decoration elements only available in full boxes.

Mosaic<sup>1</sup>

Floor Tiles<sup>1</sup>

Stair Tiles<sup>1/2</sup>

5 x 5 cm<sup>5</sup>



30 x 60 cm

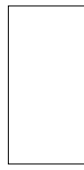

60 x 60 cm



60 x 60 cm<sup>6</sup>

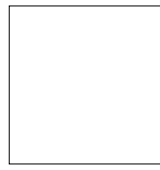

60 x 120 cm<sup>3/4</sup>

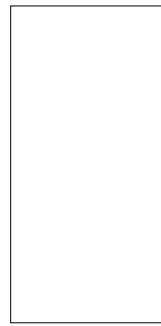

30 x 60 cm



30 x 120 cm

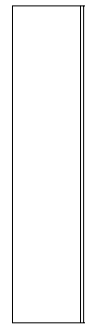

Sheet: 297 x 297 mm

extra thick

Nom. dim. - cm/in	5 x 5 / 2 x 2	30 x 60 / 12 x 24	60 x 60 / 24 x 24	60 x 60 / 24 x 24	60 x 120 / 24 x 48	30 x 60 / 12 x 24	30 x 120 / 12 x 48
Work size	47 x 47 x 9 mm	297 x 597 x 9 mm	597 x 597 x 9 mm	600 x 600 x 14 mm	597 x 1197 x 9 mm	297 x 597 x 9 mm	297 x 1197 x 9 mm
Surface	structured, matt	structured, matt	structured, matt	structured, matt	structured, matt	structured, matt	structured, matt
m <sup>2</sup> /m - pieces	11.111 sheets/m <sup>2</sup>	5.556/m <sup>2</sup>	2.778/m <sup>2</sup>	2.778/m <sup>2</sup>	1.388/m <sup>2</sup>	1.667/m	0.833/m
m <sup>2</sup> /m - kg	19.833/m <sup>2</sup>	19.907/m <sup>2</sup>	20.371/m <sup>2</sup>	31.669/m <sup>2</sup>	21.132/m <sup>2</sup>	5.973/m	6.341/m
Bundle - pieces	12 sheets	7	3	2	2	7	3
Bundle - m <sup>2</sup> /m	1.080 m <sup>2</sup>	1.260 m <sup>2</sup>	1.080 m <sup>2</sup>	0.720 m <sup>2</sup>	1.441 m <sup>2</sup>	4.199 m	3.601 m
Bundle - kg	21.420	25.081	21.999	22.800	30.450	25.081	22.836
Pallet - m <sup>2</sup>	32.400	50.396	45.356	30.238	50.432		
Pallet - kg	642.600	1,003.240	923.958	957.600	1.065.750		
Product standard	Bla	Bla	Bla	Bla	Bla	Bla	Bla
Slip resistance	R10/A+B	R10/A+B	R10/A+B	R10	R10/A+B	R10/A+B	R10/A+B
Stress group	2	2	2	4	2	2	2
ivory white	<b>431647H</b> Price gr. <b>C293</b> (m <sup>2</sup> )	<b>431652H</b> Price gr. <b>C125</b> (m <sup>2</sup> )	<b>431657H</b> Price gr. <b>C140</b> (m <sup>2</sup> )		<b>431665H</b> Price gr. <b>C152</b> (m <sup>2</sup> )	<b>431677H</b> Price gr. <b>C474</b> (pce.)	<b>431682H</b> Price gr. <b>C517</b> (pce.)
cement grey	<b>431648H</b> Price gr. <b>C293</b> (m <sup>2</sup> )	<b>431653H</b> Price gr. <b>C125</b> (m <sup>2</sup> )	<b>431658H</b> Price gr. <b>C140</b> (m <sup>2</sup> )		<b>431666H</b> Price gr. <b>C152</b> (m <sup>2</sup> )	<b>431678H</b> Price gr. <b>C474</b> (pce.)	<b>431683H</b> Price gr. <b>C517</b> (pce.)
iron grey	<b>431649H</b> Price gr. <b>C293</b> (m <sup>2</sup> )	<b>431654H</b> Price gr. <b>C125</b> (m <sup>2</sup> )	<b>431659H</b> Price gr. <b>C140</b> (m <sup>2</sup> )		<b>431667H</b> Price gr. <b>C152</b> (m <sup>2</sup> )	<b>431679H</b> Price gr. <b>C474</b> (pce.)	<b>431684H</b> Price gr. <b>C517</b> (pce.)
mud grey	<b>431650H</b> Price gr. <b>C293</b> (m <sup>2</sup> )	<b>431655H</b> Price gr. <b>C125</b> (m <sup>2</sup> )	<b>431660H</b> Price gr. <b>C140</b> (m <sup>2</sup> )		<b>431668H</b> Price gr. <b>C152</b> (m <sup>2</sup> )	<b>431680H</b> Price gr. <b>C474</b> (pce.)	<b>431685H</b> Price gr. <b>C517</b> (pce.)
slate black	<b>431651H</b> Price gr. <b>C293</b> (m <sup>2</sup> )	<b>431656H</b> Price gr. <b>C125</b> (m <sup>2</sup> )	<b>431661H</b> Price gr. <b>C140</b> (m <sup>2</sup> )		<b>431669H</b> Price gr. <b>C152</b> (m <sup>2</sup> )	<b>431681H</b> Price gr. <b>C474</b> (pce.)	<b>431686H</b> Price gr. <b>C517</b> (pce.)
terrazzo red			<b>431662H</b> Price gr. <b>C140</b> (m <sup>2</sup> )	<b>431692H</b>	<b>431695H</b> Price gr. <b>C152</b> (m <sup>2</sup> )		<b>431965H</b> Price gr. <b>C517</b> (pce.)
terrazzo black			<b>431663H</b> Price gr. <b>C140</b> (m <sup>2</sup> )	<b>431693H</b>	<b>431696H</b> Price gr. <b>C152</b> (m <sup>2</sup> )		<b>431966H</b> Price gr. <b>C517</b> (pce.)
terrazzo ivory			<b>431664H</b> Price gr. <b>C140</b> (m <sup>2</sup> )	<b>431694H</b>	<b>431697H</b> Price gr. <b>C152</b> (m <sup>2</sup> )		<b>431967H</b> Price gr. <b>C517</b> (pce.)



<sup>3</sup> High weight only to carry with two persons.  
<sup>4</sup> Important: special pallet, no return, no exchange.  
<sup>5</sup> Glass fibre net on reverse side  
<sup>6</sup> Prices are calculated project-specifically..



Skirting,  
rounded<sup>1</sup>

7 x 60 cm



Patio Tiles<sup>1/2</sup>

60 x 60 cm



120 x 120 cm<sup>3/4</sup>

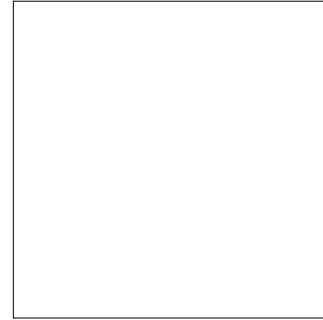

			7 x 60 / 2 13/16 x 24	60 x 60 / 24 x 24	120 x 120 / 48 x 48		Nom. dim. - cm/in
			70 x 597 x 9 mm	597 x 597 x 20 mm	1198 x 1198 x 20 mm		Work size
			structured, matt	structured, matt	structured, matt		Surface
			1.667/m	2.778/m <sup>2</sup>	0.694/m <sup>2</sup>		m <sup>2</sup> /m - pieces
			1.357/m	45.273/m <sup>2</sup>	46.567/m <sup>2</sup>		m <sup>2</sup> /m - kg
			15	2	1		Bundle - pieces
			8.998 m	0.720 m <sup>2</sup>	1.440 m <sup>2</sup>		Bundle - m <sup>2</sup> /m
			12.210	32.594	67.100		Bundle - kg
				21.598	28.560		Pallet - m <sup>2</sup>
				977.820	1,342.000		Pallet - kg
			Bla	Bla	Bla		Product standard
				R11/B	R11/B		Slip resistance
				4	4		Stress group
			<b>431687H</b>	<b>431670H</b>			ivory white <input type="checkbox"/> V3
			Price gr. C440 (pce.)	Price gr. C200 (m <sup>2</sup> )			
			<b>431688H</b>	<b>431671H</b>	<b>431675</b>		cement grey <input type="checkbox"/> V3
			Price gr. C440 (pce.)	Price gr. C200 (m <sup>2</sup> )	Price gr. C260 (m <sup>2</sup> )		
			<b>431689H</b>	<b>431672H</b>			iron grey <input type="checkbox"/> V3
			Price gr. C440 (pce.)	Price gr. C200 (m <sup>2</sup> )			
			<b>431690H</b>	<b>431673H</b>			mud grey <input type="checkbox"/> V3
			Price gr. C440 (pce.)	Price gr. C200 (m <sup>2</sup> )			
			<b>431691H</b>	<b>431674H</b>	<b>431676</b>		slate black <input type="checkbox"/> V3
			Price gr. C440 (pce.)	Price gr. C200 (m <sup>2</sup> )	Price gr. C260 (m <sup>2</sup> )		



<sup>1</sup>

<sup>2</sup> High weight only to carry with two persons.

<sup>3</sup> without Hytect coating; with Protecta upgrading

<sup>4</sup> Important: special pallet, no return, no exchange.







## Expressive and versatile

With eight formats, four colors and two slip-resistance categories, the Unique series is suitable for many areas of application. The color spectrum of the Protecta-upgraded porcelain stoneware floor tiles, which ranges from beige to anthracite, the slightly structured, discreet surface as well as the slip-resistance categories R10/A and R10/B enable versatile use, also in wet areas.

Head office of pbr Planungsbüro Rohling AG, Osnabrück, Germany  
Architect: pbr Planungsbüro Rohling AG, Osnabrück  
Photo: Martin Lukas Kim Fotografie, Hamburg



R10/A R10/B



Made in Germany



anthracite



basalt



light-grey



beige



Oblong format 5 x 60 cm, 2 x 24 in, smooth, R10/A



Oblong format 10 x 60 cm, 4 x 24 in, smooth, R10/A

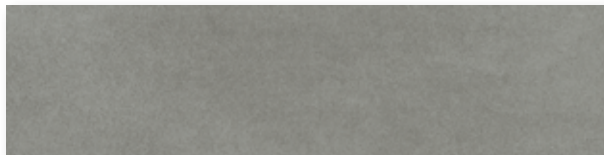

Oblong format 15 x 60 cm, 6 x 24 in, smooth, R10/A



Floor tile 30 x 30 cm, 12 x 12 in, smooth, R10/A



Floor tile 30 x 60 cm, 12 x 24 in, smooth, R10/A

### Mosaic 5 x 5 cm, 2 x 2 in

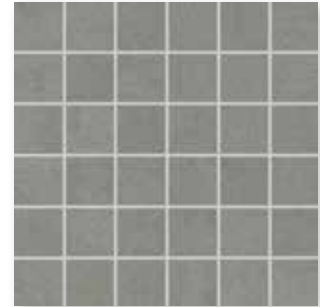

Mosaic sheet 30 x 30, 12 x 12 in, structured, R10/B



R10/A

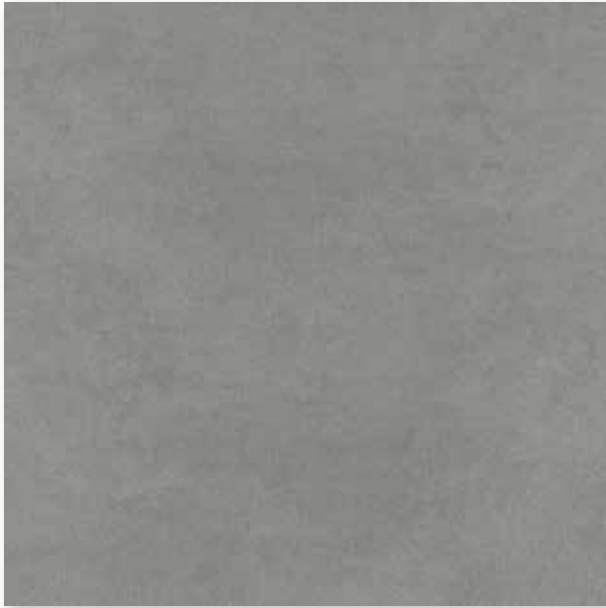

Floor tile 60 x 60 cm, 24 x 24 in, smooth, R10/A



Stair tile 30 x 60 cm, 12 x 24 in (with grooves), smooth, R10/A



Skirting, rounded 7 x 60 cm, 2 13/16 x 24 in, smooth

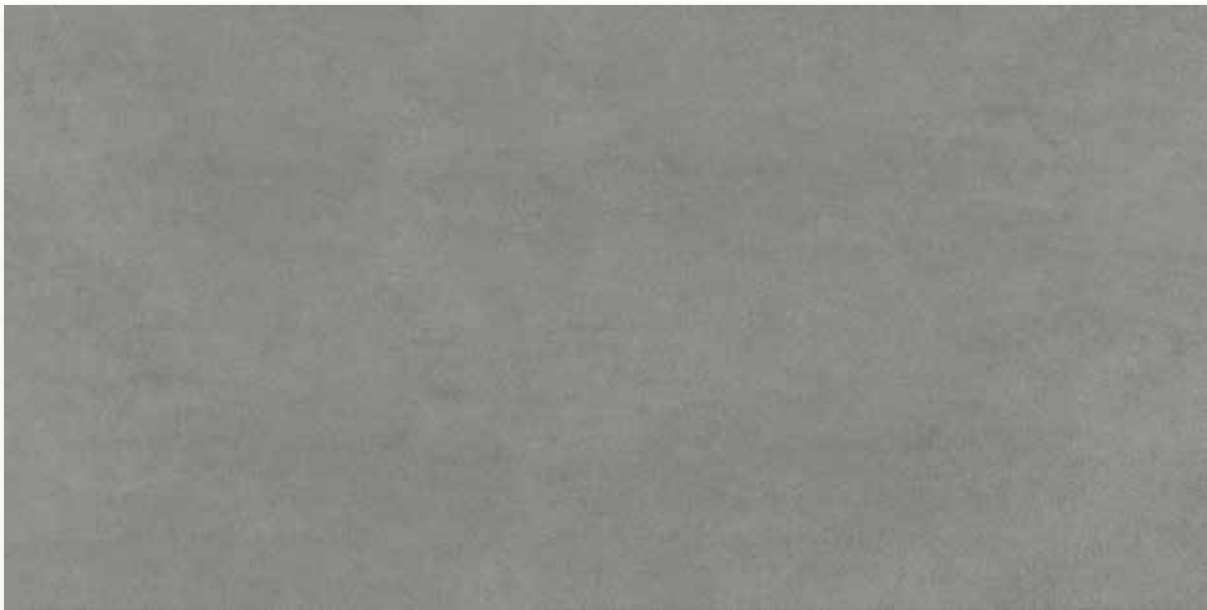

Floor tile 60 x 120 cm, 24 x 48 in, smooth, R10/A

Mosaic<sup>1/3</sup>

Floor Tiles<sup>1</sup>

5 x 5 cm



5 x 60 cm<sup>2</sup>



10 x 60 cm<sup>2</sup>



15 x 60 cm<sup>2</sup>



30 x 30 cm



30 x 60 cm





protected

Sheet: 297x297 mm

Oblong format

Oblong format

Oblong format

Nom. dim. - cm/in	5 x 5 / 2 x 2	5 x 60 / 2 x 24	10 x 60 / 4 x 24	15 x 60 / 6 x 24	30 x 30 / 12 x 12	30 x 60 / 12 x 24	
Work size	47 x 47 x 10.5 mm	47 x 597 x 10.5 mm	97 x 597 x 10.5 mm	147 x 597 x 10.5 mm	297 x 297 x 10.5 mm	297 x 597 x 10.5 mm	
Surface	structured, matt	smooth, matt	smooth, matt	smooth, matt	smooth, matt	smooth, matt	
m <sup>2</sup> - pieces	11.111	33.333	16.667	11.111	11.111	5.556	
m <sup>2</sup> - kg	21.966	21.966	21.967	21.966	21.966	21.974	
Bundle - pieces	11 sheets	33	15	11	11	6	
Bundle - m <sup>2</sup>	0.990	0.990	0.900	0.990	0.990	1.080	
Bundle - kg	21.747	21.747	19.770	21.747	21.747	23.730	
Pallet - m <sup>2</sup>	29.700	39.600	35.999	39.600	41.580	43.197	
Pallet - kg	652.410	869.880	790.800	869.880	913.374	949.200	
Product standard	Alb	Alb	Alb	Alb	Alb	Alb	
Slip resistance	R10/B	R10/A	R10/A	R10/A	R10/A	R10/A	
Stress group	2	2	2	2	2	2	
	<b>433793</b>	<b>433787</b>	<b>433770</b>	<b>433778</b>	<b>433841</b>	<b>433671</b>	
anthracite 	Price gr. <b>A265</b> (m <sup>2</sup> )	Price gr. <b>A211</b> (m <sup>2</sup> )	Price gr. <b>A211</b> (m <sup>2</sup> )	Price gr. <b>A199</b> (m <sup>2</sup> )	Price gr. <b>A115</b> (m <sup>2</sup> )	Price gr. <b>A127</b> (m <sup>2</sup> )	
	<b>433794</b>	<b>433786</b>	<b>433771</b>	<b>433779</b>	<b>433842</b>	<b>433672</b>	
basalt 	Price gr. <b>A265</b> (m <sup>2</sup> )	Price gr. <b>A211</b> (m <sup>2</sup> )	Price gr. <b>A211</b> (m <sup>2</sup> )	Price gr. <b>A199</b> (m <sup>2</sup> )	Price gr. <b>A115</b> (m <sup>2</sup> )	Price gr. <b>A127</b> (m <sup>2</sup> )	
	<b>433795</b>	<b>433789</b>	<b>433772</b>	<b>433780</b>	<b>433843</b>	<b>433673</b>	
light-grey 	Price gr. <b>A265</b> (m <sup>2</sup> )	Price gr. <b>A211</b> (m <sup>2</sup> )	Price gr. <b>A211</b> (m <sup>2</sup> )	Price gr. <b>A199</b> (m <sup>2</sup> )	Price gr. <b>A115</b> (m <sup>2</sup> )	Price gr. <b>A127</b> (m <sup>2</sup> )	
	<b>433796</b>	<b>433891</b>	<b>433773</b>	<b>433781</b>	<b>433844</b>	<b>433674</b>	
beige 	Price gr. <b>A265</b> (m <sup>2</sup> )	Price gr. <b>A211</b> (m <sup>2</sup> )	Price gr. <b>A211</b> (m <sup>2</sup> )	Price gr. <b>A199</b> (m <sup>2</sup> )	Price gr. <b>A115</b> (m <sup>2</sup> )	Price gr. <b>A127</b> (m <sup>2</sup> )	

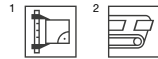

<sup>3</sup> Glass fibre net on reverse side

Floor Tiles<sup>1</sup>

Stair Tiles<sup>1/2</sup>

Skirting, rounded<sup>1</sup>

60 x 60 cm

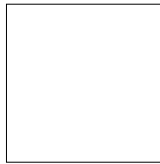

60 x 120 cm<sup>3</sup>



30 x 60 cm



7 x 60 cm



protected

			60 x 60 / 24 x 24	60 x 120 / 24 x 48	30 x 60 / 12 x 24	7 x 60 / 2 13/16 x 24	Nom. dim. - cm/in
			597 x 597 x 10.5 mm	597 x 1197 x 8 mm	297 x 597 x 10.5 mm	70 x 597 x 10.5 mm	Work size
			smooth, matt	smooth, matt	smooth, matt	smooth, matt	Surface
			2.778/m <sup>2</sup>	1.388/m <sup>2</sup>	1.667/m	1.667/m	m <sup>2</sup> /m - pieces
			21.996/m <sup>2</sup>	17.489/m <sup>2</sup>	6.593/m	1.554/m	m <sup>2</sup> /m - kg
			3	2	6	15	Bundle - pieces
			1.080 m <sup>2</sup>	1.441 m <sup>2</sup>	3.599 m	8.998 m	Bundle - m <sup>2</sup> /m
			23.754	25.200	23.730	13.980	Bundle - kg
			32.397	36.023			Pallet - m <sup>2</sup>
			712.620	630.000			Pallet - kg
			Alb	Alb	Alb	Alb	Product standard
			R10/A	R10/A	R10/A		Slip resistance
			2	2	2		Stress group
			<b>433701</b>	<b>434432</b>	433678	<b>433685</b>	anthracite <input type="checkbox"/> V2
			Price gr. <b>A142</b> (m <sup>2</sup> )	Price gr. <b>A169</b> (m <sup>2</sup> )	Price gr. <b>A465</b> (pce.)	Price gr. <b>A441</b> (pce.)	
			<b>433702</b>	<b>434433</b>	433679	<b>433686</b>	basalt <input type="checkbox"/> V2
			Price gr. <b>A142</b> (m <sup>2</sup> )	Price gr. <b>A169</b> (m <sup>2</sup> )	Price gr. <b>A465</b> (pce.)	Price gr. <b>A441</b> (pce.)	
			<b>433703</b>	<b>434434</b>	433680	<b>433687</b>	light-grey <input type="checkbox"/> V2
			Price gr. <b>A142</b> (m <sup>2</sup> )	Price gr. <b>A169</b> (m <sup>2</sup> )	Price gr. <b>A465</b> (pce.)	Price gr. <b>A441</b> (pce.)	
			<b>433704</b>	<b>434435</b>	433681	<b>433688</b>	beige <input type="checkbox"/> V2
			Price gr. <b>A142</b> (m <sup>2</sup> )	Price gr. <b>A169</b> (m <sup>2</sup> )	Price gr. <b>A465</b> (pce.)	Price gr. <b>A441</b> (pce.)	

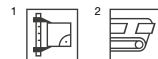

<sup>3</sup> High weight only to carry with two persons.









## Natural and lively

The Valley porcelain stoneware series was inspired by the panorama of the distant landscape of a valley plain. Its earthy relief and its fine, grainy textures bear witness to this. Each color evokes different associations: of blue or clay slate, river pebbles, sand and earth. The effects of the weather, earth movements, water flows and metallic material deposits also create a lively surface with a typical "mountain-valley" effect. The series is rounded off by an extra thick, frost-resistant patio tile in all four colors, which is also suitable for laying in sand or gravel.

Wellness Hostel 4000, Saas Fee, Switzerland  
Architect: Steinmann & Schmid Arch. AG BSA SIA  
Photo: Adriano Faragulo



R10/A R10/B R11/B



schiefer



pebble-grey



earth-brown



sand-beige



Oblong format 5 x 60 cm, 2 x 24 in, structured, R10/A



Oblong format 10 x 60 cm, 4 x 24 in, structured, R10/A



Oblong format 15 x 60 cm, 6 x 24 in, structured, R10/A

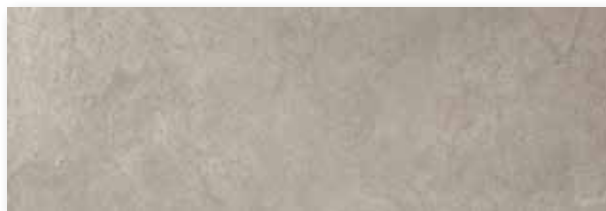

Oblong format 20 x 60 cm, 8 x 24 in, structured, R10/A

### Mosaic 5 x 5 cm, 2 x 2 in



Mosaic sheet 30 x 30 cm, 12 x 12 in smooth, R11/B



Floor/wall tile 15 x 15 cm, 6 x 6 in structured, R10/B



Floor/wall tile 30 x 30 cm structured, R11/B



Floor/wall tile 30 x 60 cm, 12 x 24 in, structured, R10/A  
Floor/wall tile 30 x 60 cm, 12 x 24 in, structured, R11/B



Floor tile 60 x 60 cm, 24 x 24 in, structured, R10/A  
Patio tile 60 x 60 cm, 24 x 24 in, structured, R11/B

Ceramic cover channel,  
25 x 50 cm, 10 x 20 in



Ceramic cover channel,  
corner solution 30 x 30 cm,  
12 x 12 in



For details about the Ceramic channel cover,  
refer to the Pool + Spa programme of delivery.



Floor tile 60 x 120 cm, 24 x 48 in, structured, R10/A



Skirting, rounded 7 x 60 cm, 2 13/16 x 24 in, structured



Stair tile 30 x 60 cm, 12 x 24 in (with grooves), structured, R10/A

Mosaic<sup>1/3</sup> Floor/Wall Tiles<sup>1</sup>

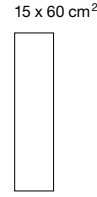

protected

Sheet: 297 x 297 mm

Oblong format

Oblong format

Oblong format

Oblong format

Nom. dim. - cm/in	5 x 5 / 2 x 2	15 x 15 / 6 x 6	5 x 60 / 2 x 24	10 x 60 / 4 x 24	15 x 60 / 6 x 24	20 x 60 / 8 x 24
Work size	47 x 47 x 10 mm	147 x 147 x 8 mm	46 x 596 x 10 mm	96 x 596 x 10 mm	146 x 596 x 10 mm	196 x 596 x 10 mm
Surface	structured, matt	structured, matt	structured, matt	structured, matt	structured, matt	structured, matt
m <sup>2</sup> - pieces	11.111	44.444	33.333	16.667	11.111	8.333
m <sup>2</sup> - kg	21.800	17.555	22.233	22.667	22.000	23.749
Bundle - pieces	11 sheets	35	33	15	11	8
Bundle - m <sup>2</sup>	0.990	0.788	0.990	0.900	0.990	0.960
Bundle - kg	21.582	13.825	22.011	20.400	21.780	22.800
Pallet - m <sup>2</sup>	29.700	63.001	39.600	35.999	39.600	40.322
Pallet - kg	647.460	1,106.000	880.440	816.000	871.200	957.600
Product standard	Bla	Bla	Bla	Bla	Bla	Bla
Slip resistance	R11/B	R10/B	R10/A	R10/A	R10/A	R10/A
Stress group	2	2	2	2	2	2
slate	<b>052089</b> Price gr. <b>A292</b> (m <sup>2</sup> )	<b>052477</b> Price gr. <b>A142</b> (m <sup>2</sup> )	<b>052044</b> Price gr. <b>A217</b> (m <sup>2</sup> )	<b>052048</b> Price gr. <b>A217</b> (m <sup>2</sup> )	<b>052052</b> Price gr. <b>A211</b> (m <sup>2</sup> )	<b>052461</b> Price gr. <b>A211</b> (m <sup>2</sup> )
pebble-grey	<b>052090</b> Price gr. <b>A292</b> (m <sup>2</sup> )	<b>052478</b> Price gr. <b>A142</b> (m <sup>2</sup> )	<b>052045</b> Price gr. <b>A217</b> (m <sup>2</sup> )	<b>052049</b> Price gr. <b>A217</b> (m <sup>2</sup> )	<b>052053</b> Price gr. <b>A211</b> (m <sup>2</sup> )	<b>052462</b> Price gr. <b>A211</b> (m <sup>2</sup> )
earth-brown	<b>052091</b> Price gr. <b>A292</b> (m <sup>2</sup> )	<b>052479</b> Price gr. <b>A142</b> (m <sup>2</sup> )	<b>052046</b> Price gr. <b>A217</b> (m <sup>2</sup> )	<b>052050</b> Price gr. <b>A217</b> (m <sup>2</sup> )	<b>052054</b> Price gr. <b>A211</b> (m <sup>2</sup> )	<b>052463</b> Price gr. <b>A211</b> (m <sup>2</sup> )
sand-beige	<b>052092</b> Price gr. <b>A292</b> (m <sup>2</sup> )	<b>052480</b> Price gr. <b>A142</b> (m <sup>2</sup> )	<b>052047</b> Price gr. <b>A217</b> (m <sup>2</sup> )	<b>052051</b> Price gr. <b>A217</b> (m <sup>2</sup> )	<b>052055</b> Price gr. <b>A211</b> (m <sup>2</sup> )	<b>052464</b> Price gr. <b>A211</b> (m <sup>2</sup> )



Floor/Wall Tiles<sup>1</sup>

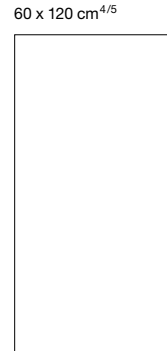
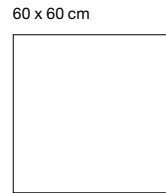
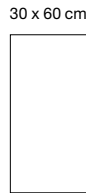
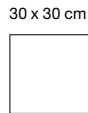

protected

Nom. dim. - cm/in	30 x 30 / 12 x 12	30 x 60 / 12 x 24	30 x 60 / 12 x 24	60 x 60 / 24 x 24	60 x 120 / 24 x 48
Work size	297 x 297 x 10 mm	297 x 596 x 10 mm	297 x 596 x 10 mm	596 x 596 x 10 mm	596 x 1195 x 10.5 mm
Surface	structured, matt	structured, matt	structured, matt	structured, matt	structured, matt
m <sup>2</sup> - pieces	11.111	5.556	5.556	2.778	1.388
m <sup>2</sup> - kg	23.144	22.780	22.780	22.780	23.180
Bundle - pieces	11	6	6	3	2
Bundle - m <sup>2</sup>	0.990	1.080	1.080	1.080	1.441
Bundle - kg	22.913	24.600	24.600	24.600	33.400
Pallet - m <sup>2</sup>	41.580	43.197	43.197	43.197	50.432
Pallet - kg	962.346	984.000	984.000	984.000	1,169.000
Product standard	Bla	Bla	Bla	Bla	Bla
Slip resistance	R11/B	R10/A	R11/B	R10/A	R10/A
Stress group	3	2	2	3	2
slate	<b>052032</b> Price gr. <b>A121</b> (m <sup>2</sup> )	<b>052016</b> Price gr. <b>A109</b> (m <sup>2</sup> )	<b>052036</b> Price gr. <b>A121</b> (m <sup>2</sup> )	<b>052020</b> Price gr. <b>A121</b> (m <sup>2</sup> )	<b>052024</b> Price gr. <b>A154</b> (m <sup>2</sup> )
pebble-grey	<b>052033</b> Price gr. <b>A121</b> (m <sup>2</sup> )	<b>052017</b> Price gr. <b>A109</b> (m <sup>2</sup> )	<b>052037</b> Price gr. <b>A121</b> (m <sup>2</sup> )	<b>052021</b> Price gr. <b>A121</b> (m <sup>2</sup> )	<b>052025</b> Price gr. <b>A154</b> (m <sup>2</sup> )
earth-brown	<b>052034</b> Price gr. <b>A121</b> (m <sup>2</sup> )	<b>052018</b> Price gr. <b>A109</b> (m <sup>2</sup> )	<b>052038</b> Price gr. <b>A121</b> (m <sup>2</sup> )	<b>052022</b> Price gr. <b>A121</b> (m <sup>2</sup> )	<b>052026</b> Price gr. <b>A154</b> (m <sup>2</sup> )
sand-beige	<b>052035</b> Price gr. <b>A121</b> (m <sup>2</sup> )	<b>052019</b> Price gr. <b>A109</b> (m <sup>2</sup> )	<b>052039</b> Price gr. <b>A121</b> (m <sup>2</sup> )	<b>052023</b> Price gr. <b>A121</b> (m <sup>2</sup> )	<b>052027</b> Price gr. <b>A154</b> (m <sup>2</sup> )

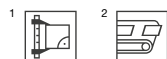

<sup>3</sup> Glass fibre net on reverse side  
<sup>4</sup> High weight only to carry with two persons.

<sup>5</sup> Please note: special pallet. No return, no exchange.

Stair Tiles<sup>1/2</sup>

30 x 60 cm



Skirting, rounded<sup>1</sup>

7 x 60 cm



Patio Tile<sup>1/3</sup>

60 x 60 cm

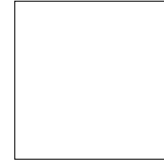

protected

				<b>30 x 60</b> / 12 x 24	<b>7 x 60</b> / 2 13/16 x 24	<b>60 x 60</b> / 24 x 24	Nom. dim. - <b>cm/in</b>	
				297 x 596 x 10 mm	70 x 596 x 10 mm	596 x 596 x 20 mm	Work size	
				structured, matt	structured, matt	structured, matt	Surface	
				1.667/m	1.667/m	2.778/m <sup>2</sup>	<b>m<sup>2</sup>/m</b> - pieces	
				6.968/m	1.550/m	46.948/m <sup>2</sup>	<b>m<sup>2</sup>/m</b> - kg	
				6	22	2	<b>Bundle</b> - pieces	
				3.599 m	13.197 m	0.720 m <sup>2</sup>	<b>Bundle</b> - m <sup>2</sup> /m	
				25.080	20.460	33.800	<b>Bundle</b> - kg	
						21.598	<b>Pallet</b> - m <sup>2</sup>	
						1,014.000	<b>Pallet</b> - kg	
				Bla	Bla	Bla	Product standard	
				R10/A		R11/B	Slip resistance	
				2		4	Stress group	
				<b>052068</b>	<b>052072</b>	<b>052085</b>	slate	<input type="checkbox"/> V2
				Price gr. <b>A475</b> (pce.)	Price gr. <b>A438</b> (pce.)	Price gr. <b>A178</b> (m <sup>2</sup> )		
				<b>052069</b>	<b>052073</b>	<b>052086</b>	pebble-grey	<input type="checkbox"/> V2
				Price gr. <b>A475</b> (pce.)	Price gr. <b>A438</b> (pce.)	Price gr. <b>A178</b> (m <sup>2</sup> )		
				<b>052070</b>	<b>052074</b>	<b>052087</b>	earth-brown	<input type="checkbox"/> V2
				Price gr. <b>A475</b> (pce.)	Price gr. <b>A438</b> (pce.)	Price gr. <b>A178</b> (m <sup>2</sup> )		
				<b>052071</b>	<b>052075</b>	<b>052088</b>	sand-beige	<input type="checkbox"/> V2
				Price gr. <b>A475</b> (pce.)	Price gr. <b>A438</b> (pce.)	Price gr. <b>A178</b> (m <sup>2</sup> )		

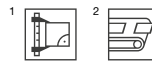

<sup>3</sup> High weight only to carry with two persons.





## Powerful, relaxed and timeless

Walden is a classic, natural wood design manufactured in high-quality ceramics. It is a natural product which combines the popularity of authentic wood surfaces with the advantages of ceramic covering materials. The 5 color shades in the classic 20 x 120 cm plank format serve a wide range of different styles and can be combined harmoniously or in contrast with other materials as desired. The slip resistance R10/A+B provides for versatile application possibilities in private and public interiors.

Rendering



R10/A+B



sunny white



relax beige



classic oak



brown cherry



smokey brown



Floor tile 20 x 120 cm, 8 x 48 in, structured, R10/A+B



Skirting, rounded 6 x 60 cm, 2 3/8 x 24 in, structured



Floor Tile<sup>1/2</sup>

Skirting rounded<sup>1</sup>

20 x 120 cm

6 x 60 cm



protected

					20 x 120 / 8 x 48	6 x 60 / 2 3/8 x 24	Nom. dim. - cm/in
					197 x 1195 x 9 mm	60 x 596 x 9 mm	Work size
					structured, matt	structured, matt	Surface
					4.166/m <sup>2</sup>	1.667/m	m <sup>2</sup> /m - pieces
					20.830/m <sup>2</sup>	1.237/m	m <sup>2</sup> /m - kg
					6	27	Bundle - pieces
					1.440 m <sup>2</sup>	16.197 m	Bundle - m <sup>2</sup> /m
					30.000	20.034	Bundle - kg
					60.490		Pallet - m <sup>2</sup>
					1,260.000		Pallet - kg
					Bla	Bla	Product standard
					R10/A+B		Slip resistance
					2		Stress group
					<b>430685</b>	<b>430690</b>	
					Price gr. C143 (m <sup>2</sup> )	Price gr. C437 (pce.)	sunny white <input type="checkbox"/> V2
					<b>430686</b>	<b>430691</b>	
					Price gr. C143 (m <sup>2</sup> )	Price gr. C437 (pce.)	relax beige <input type="checkbox"/> V2
					<b>430687</b>	<b>430692</b>	
					Price gr. C143 (m <sup>2</sup> )	Price gr. C437 (pce.)	classic oak <input type="checkbox"/> V2
					<b>430688</b>	<b>430693</b>	
					Price gr. C143 (m <sup>2</sup> )	Price gr. C437 (pce.)	brown cherry <input type="checkbox"/> V2
					<b>430689</b>	<b>430694</b>	
					Price gr. C143 (m <sup>2</sup> )	Price gr. C437 (pce.)	smokey brown <input type="checkbox"/> V2



<sup>2</sup> Please note: special pallet. No return, no exchange.







## Contents

• Article numbers	500 - 510
• Index according to models	511 - 512
• Model numbers	513
• Classification accord. to NCS/RAL / Lightness values	514 - 515
• Luminance contrast	516 - 519
<b>Technical information</b>	520 - 539
<b>World-wide distribution network</b>	542 - 543
<b>Comments</b>	546 - 547



As of now, you will find all article numbers for our pool edge systems and swimming pool special pieces in our Pool + Spa programme of delivery.

Article No.	Page(s)	Article No.	Page(s)	Article No.	Page(s)	Article No.	Page(s)	Article No.	Page(s)	Article No.	Page(s)
0002	301	052480	492	130-1050H	346	182763	107	203416H	479	239996	107
010D-1010	291	101630-6635	127	130-1111H	344	182764	107	203417H	479	239997	107
010D-1630	291	101630-6636	127	130-1112H	344	183343	107	203431H	454	239998	107
052016	492	103197-6635	127	130-1113H	344	183344	107	203432H	454	240-1001H	344
052017	492	103197-6636	127	130-1115H	344	19020-2290H	181	203433H	454	240-1002H	344
052018	492	111052	107	130-1117H	344	19020-2320H	181	203434H	454	240-1003H	344
052019	492	112000	107	130-1118H	344	19020-9215H	181	203435H	44	240-1004H	344
052020	492	113063	107	130-1119H	344	19021-2290H	181	203436H	44	240-1005H	344
052021	492	115100	107	130-1120H	344	19021-2320H	181	203439	44	240-1006H	344
052022	492	130-1001H	344	130-1121H	344	19021-9215H	181	203440	44	240-1007H	344
052023	492	130-1002H	344	133420H	479	19022-2290H	181	203441	44	240-1008H	344
052024	492	130-1003H	344	133421H	479	19022-2320H	181	203442	44	240-1009H	344
052025	492	130-1004H	344	133422H	479	19022-9215H	181	203443	44	240-1010H	344
052026	492	130-1005H	344	133423H	479	19024-2290H	181	203444	108	240-1011H	344
052027	492	130-1006H	344	133424H	479	19024-2320H	181	203445	108	240-1012H	344
052032	492	130-1007H	344	133425H	479	19024-9215H	181	203459R	108	240-1013H	344
052033	492	130-1008H	344	133426H	479	19025-2290H	181	203460R	108	240-1014H	344
052034	492	130-1009H	344	133427H	479	19025-2320H	181	203461HR	109	240-1015H	344
052035	492	130-1010H	344	144-12020	149	19025-9215H	181	203462HR	109	240-1016H	344
052036	492	130-1011H	344	144-12050	149	19026-2290H	181	203479H	214	240-1017H	345
052037	492	130-1012H	344	144-18120	149	19026-2320H	181	203480H	214	240-1018H	345
052038	492	130-1013H	344	144-18210	149	19026-9215H	181	203481H	214	240-1019H	345
052039	492	130-1014H	344	144-41550K	149	19027-2290H	181	203482H	214	240-1020H	345
052044	492	130-1015H	344	144-42550K	149	19027-2320H	181	203505H	420	240-1021H	345
052045	492	130-1016H	344	150i-12020H	149	19027-9215H	181	203506H	420	240-1022H	345
052046	492	130-1017H	345	150i-12050H	149	19030-2290H	181	203507H	420	240-1023H	345
052047	492	130-1018H	345	150i-18120H	149	19030-2320H	181	203508H	420	240-1024H	345
052048	492	130-1019H	345	150i-18210H	149	19030-9215H	181	203509H	420	240-1025H	345
052049	492	130-1020H	345	150i-41550HK	149	19031-2290H	181	203510H	420	240-1026H	345
052050	492	130-1021H	345	150i-42550HK	149	19031-2320H	181	203511	437	240-1027H	345
052051	492	130-1022H	345	151i-12020H	149	19031-9215H	181	203512	437	240-1028H	345
052052	492	130-1023H	345	151i-12050H	149	19032-2290H	181	203513	437	240-1029H	345
052053	492	130-1024H	345	151i-18120H	149	19032-2320H	181	203514	437	240-1030H	345
052054	492	130-1025H	345	151i-18210H	149	19032-9215H	181	203515	437	240-1031H	345
052055	492	130-1026H	345	151i-41550HK	149	19033-2290H	181	203516	437	240-1032H	345
052068	493	130-1027H	345	151i-42550HK	149	19033-2320H	181	203517	437	240-1033H	345
052069	493	130-1028H	345	152i-12020H	149	19033-9215H	181	203518	437	240-1034H	345
052070	493	130-1029H	345	152i-12050H	149	203225H	84	203519	437	240-1035H	345
052071	493	130-1030H	345	152i-18120H	149	203226H	84	203520	437	240-1036H	345
052072	493	130-1031H	345	152i-18210H	149	203229H	84	203521	437	240-1037H	345
052073	493	130-1032H	345	152i-41550HK	149	203232H	66	203522	437	240-1038H	345
052074	493	130-1033H	345	152i-42550HK	149	203233H	66	203523	437	240-1039H	345
052075	493	130-1034H	345	153i-12020H	149	203234H	66	203524	437	240-1040H	345
052085	493	130-1035H	345	153i-12050H	149	203264	108	203525	437	240-1111H	344
052086	493	130-1036H	345	153i-18120H	149	203265	108	203526	437	240-1112H	344
052087	493	130-1037H	345	153i-18210H	149	203266H	109	203527	437	240-1113H	344
052088	493	130-1038H	345	153i-41550HK	149	203267H	109	203528	437	240-1115H	344
052089	492	130-1039H	345	153i-42550HK	149	203331H	391	213341	107	240-1117H	344
052090	492	130-1040H	345	154i-12020H	149	203333H	84	213342	107	240-1118H	344
052091	492	130-1041H	346	154i-12050H	149	203392H	271	2203-B600HK	245	240-1119H	344
052092	492	130-1042H	346	154i-18120H	149	203393H	271	2204-B600HK	245	240-1120H	344
052461	492	130-1043H	346	154i-18210H	149	203394H	271	2205-B600HK	245	240-1121H	344
052462	492	130-1044H	346	154i-41550HK	149	203408	398	2206-B600HK	245	2401RH-K100-21	189
052463	492	130-1045H	346	154i-42550HK	149	203409	398	2207-B600HK	245	2452	233
052464	492	130-1046H	346	173339	107	203410	398	2208-B600HK	245	2455	233
052477	492	130-1047H	346	173340	107	203411	398	231032	107	280345	171
052478	492	130-1048H	346	173368	107	203412H	398	231034	107	280349-73	171
052479	492	130-1049H	346	173369	107	203413H	398	239995	107	280350-73	171



Article No.	Page(s)	Article No.	Page(s)	Article No.	Page(s)	Article No.	Page(s)	Article No.	Page(s)	Article No.	Page(s)
430293H	68	430355H	68	430416H	69	430497H	70	430660	254	430757H	96
430294H	68	430356H	68	430417H	69	430498H	70	430661	254	430758H	96
430295H	68	430357H	68	430418H	69	430499H	70	430662	254	430759H	96
430296H	68	430358H	68	430419H	69	430500H	70	430663	254	430760H	96
430297H	68	430359H	68	430420H	69	430501H	70	430664	254	430761H	96
430298H	68	430360H	68	430421H	69	430502H	70	430665	255	430762H	96
430299H	68	430361H	68	430422	70	430503H	70	430666	255	430763H	96
430300H	68	430362H	68	430423	70	430504H	72	430667	255	430764H	96
430301H	68	430363H	68	430424	70	430505H	72	430668	255	430765H	96
430302H	68	430364H	68	430425	70	430506H	72	430669	255	430766H	96
430303H	68	430365H	68	430426	70	430507H	72	430670	255	430767H	96
430304-N	125	430366H	68	430427	70	430508H	72	430671	255	430768H	96
430304H	68	430367H	68	430428H	70	430509H	72	430672	255	430769H	96
430304H-N	125	430368H	68	430429H	70	430510H	72	430673	255	430770H	96
430304H-N	74	430369H	68	430430H	70	430511H	72	430674	255	430771H	96
430304H-R	74, 125	430370H	68	430431H	70	430512H	72	430675	255	430772H	96
430305H	68	430371H	68	430432H	70	430513H	72	430676	255	430773H	96
430306H	68	430372H	68	430433H	70	430514H	72	430677	255	430774H	96
430307H	68	430373H	68	430434H	70	430515H	72	430678	255	430775H	96
430308H	68	430374H	68	430435H	70	430516H	73	430679	255	430776H	96
430309H	68	430375H	68	430436H	70	430517H	73	430680	255	430777H	96
430310H	68	430380H	69	430437H	70	430518H	73	430681	255	430778H	96
430311H	68	430381H	69	430438H	70	430519H	73	430684	298	430779H	97
430312-N	125	430382H	69	430439H	70	430520H	73	430685	497	430780H	97
430312H	68	430383H	69	430440H	70	430521H	73	430686	497	430781H	97
430312H-N	74, 125	430384H	69	430441H	70	430522H	73	430687	497	430782H	97
430312H-R	74, 125	430385H	69	430442H	70	430523H	73	430688	497	430783H	97
430313H	68	430386H	69	430443H	70	430524H	73	430689	497	430784H	97
430314H	68	430387H	69	430444H	70	430525H	73	430690	497	430785H	97
430315H	68	430388H	69	430445H	70	430526H	73	430691	497	430786H	97
430316H	68	430389H	69	430446H	70	430527H	73	430692	497	430787H	97
430317H	68	430390H	69	430447H	70	430528H	73	430693	497	430788H	97
430318H	68	430391H	69	430448H	70	430529H	73	430694	497	430789H	97
430319H	68	430392H	69	430449H	70	430530H	73	430701H	93	430790H	97
430320H	68	430393H	69	430450H	70	430531H	73	430702H	93	430791H	97
430321H	68	430394H	69	430451H	70	430532H	73	430703H	93	430792H	97
430322H	68	430395H	69	430452H	70	430533H	73	430704H	93	430793H	97
430323H	68	430396H	69	430453H	70	430534H	73	430705H	93	430794H	97
430324H	68	430397H	69	430454H	70	430535H	73	430706H	93	430795H	97
430325H	68	430398H	69	430455H	70	430536H	73	430707H	93	430796H	97
430326H	68	430398H-TF	72	430456H	70	430537H	73	430708H	93	430797H	85
430327H	68	430398H-TK	73	430457H	70	430538H	73	430709H	93	430798H	85
430328H	68	430399H	69	430458H	70	430539H	73	430710H	93	430802H	97
430329H	68	430399H-TF	72	430459H	70	430564H	70	430711H	93	430803H	97
430330H	68	430399H-TK	73	430460H	70	430565H	70	430712H	93	430804H	97
430331H	68	430400H	69	430461H	70	430566H	70	430713H	93	430805H	97
430332H	68	430400H-TF	72	430462H	70	430567H	70	430714H	93	430806H	98
430333H	68	430400H-TK	73	430463H	70	430568H	70	430715H	93	430807H	98
430334H	68	430401H	69	430464H	72	430569H	70	430716H	93	430808H	98
430335H	68	430401H-TF	72	430465H	72	430570H	70	430717H	95	430809H	98
430336H	68	430401H-TK	73	430466H	72	430571H	70	430718H	95	430810H	98
430337H	68	430402H	69	430467H	72	430572H	70	430719H	95	430811H	98
430338H	68	430402H-TF	72	430468H	72	430573H	70	430720H	95	430812H	98
430339H	68	430402H-TK	73	430469H	72	430574H	70	430721H	93	430813H	98
430340H	68	430403H	69	430470H	72	430575H	70	430722H	93	430814H	98
430340H-TK	73	430403H-TF	72	430471H	72	430599H	309	430723H	93	430815H	98
430341H	68	430403H-TK	73	430472H	72	430635	253	430724H	93	430816H	98
430341H-TK	73	430404H	69	430473H	72	430636	253	430725H	93	430817H	98
430342H	68	430404H-TF	72	430474H	72	430637	253	430726H	93	430818H	98
430342H-TK	73	430404H-TK	73	430475H	72	430638	253	430727H	93	430819H	98
430343H	68	430405H	69	430476H	72	430639	253	430728H	93	430820H	98
430343H-TK	73	430405H-TF	72	430476H-TF	72	430640	253	430729H	94	430821H	98
430344H	68	430405H-TK	73	430476H-TK	73	430641	253	430730H	94	430822H	98
430344H-TK	73	430406H	69	430477H	72	430642	253	430731H	94	430823H	98
430345H	68	430406H-TF	72	430480H	70	430643	253	430732H	94	430824H	98
430345H-TK	73	430406H-TK	73	430481H	70	430644	253	430733H	94	430825H	98
430346H	68	430407H	69	430482H	70	430645	254	430734H	94	430826H	99
430346H-TK	73	430407H-TF	72	430483H	70	430646	254	430735H	94	430827H	99
430347H	68	430407H-TK	73	430484H	70	430647	254	430736H	94	430828H	99
430347H-TK	73	430408H	69	430485H	70	430648	254	430737H	95	430829H	99
430348H	68	430408H-TF	72	430486H	70	430649	254	430738H	95	430834H	85
430348H-TK	73	430408H-TK	73	430487H	70	430650	254	430739H	95	430835H	85
430349H	68	430409H	69	430488H	70	430651	254	430740H	95	430836H	85
430349H-TK	73	430409H-TF	72	430489H	70	430652	254	430741H	95	430837H	85
430350H	68	430409H-TK	73	430490H	70	430653	254	430742H	95	430838H	85
430350H-TK	73	430410H	69	430491H	70	430654	254	430743H	95	430839H	85
430351H	68	430411H	69	430492H	70	430655	254	430744H	95	430840H	85
430351H-TK	73	430412H	69	430493H	70	430656	254	430753H	96	430841H	85
430352H	68	430413H	69	430494H	70	430657	254	430754H	96	430842H	85
430353H	68	430414H	69	430495H	70	430658	254	430755H	96	430843H	85
430354H	68	430415H	69	430496H	70	430659	254	430756H	96	430844H	85

Article No.	Page(s)	Article No.	Page(s)	Article No.	Page(s)	Article No.	Page(s)	Article No.	Page(s)	Article No.	Page(s)
430845H	85	430927	119	431116H	287	431489	45	431580H-TF	94	431679H	480
430846H	85	430928	119	431117H	287	431490	45	431581H	94	431680H	480
430847H	85	430929	119	431118H	287	431491	45	431581H-TF	94	431681H	480
430848H	85	430930	119	431119H	287	431492	45	431582H	94	431682H	480
430849H	85	430931	119	431120H	287	431493	45	431583H	94	431683H	480
430850H	85	430932	119	431121H	287	431494	45	431584H	94	431684H	480
430851H	85	430933	119	431122H	287	431495	45	431585H	94	431685H	480
430853	430	430934	119	431320	201	431496	45	431586H	94	431686H	480
430854	430	430935	119	431321	201	431497	45	431587H	94	431687H	481
430855	430	430936	119	431328H	272	431498	45	431601H	399	431688H	481
430856	430	430937	119	431329H	272	431499	45	431602H	399	431689H	481
430857	430	430938	119	431330H	272	431501H	93	431603H	399	431690H	481
430858	430	430939	119	431331H	272	431502H	93	431604H	399	431691H	481
430859	430	430940	119	431332H	272	431503H	93	431605H	399	431692H	299, 480
430860	430	430941	119	431333H	272	431504H	93	431606H	399	431693H	299, 480
430861	430	430942	119	431334H	272	431505H	93	431607H	399	431694H	299, 480
430862	430	430943	119	431335H	272	431506H	93	431608H	399	431695H	480
430863	430	430944	119	431336H	272	431507H	93	431609H	399	431696H	480
430864	430	430945	119	431337H	272	431508H	93	431610H	399	431697H	480
430865	430	430946	120	431338H	272	431509H	93	431611H	399	431715H	309
430866	430	430947	120	431339H	272	431510H	93	431612H	399	431716H	309
430867	430	430948	120	431340H	272	431511H	93	431613H	399	431717H	309
430868	430	430949	120	431341H	272	431512H	93	431614H	399	431718H	309
430869	430	430950	120	431342H	272	431513H	94	431615H	399	431719H	309
430870	430	430951	120	431343H	272	431514H	94	431616H	399	431720H	309
430871	430	430952	120	431344	272	431515H	94	431617H	399	431721H	309
430872	430	430953	120	431345	272	431516H	94	431618H	399	431722H	309
430873	430	430954	120	431346	272	431523H	95	431619H	399	431723H	309
430874	430	430955	120	431347	272	431524H	95	431620H	399	431727H	309
430875	430	430956	120	431348H	272	431525H	95	431621H	399	431736H	309
430876	430	430957	120	431349H	272	431526H	95	431622H	399	431744H	307
430877	430	430958	120	431350H	272	431527H	95	431623H	399	431745H	307
430878	430	430959	120	431351H	272	431528H	95	431624H	399	431746H	307
430879	430	430960	120	431352H	410	431529H	95	431630H	455	431747H	307
430880	430	430963	110	431353H	410	431530H	95	431631H	455	431748H	307
430881	431	430964	110	431354H	410	431531H	95	431632H	455	431749H	307
430882	431	430965	110	431355H	410	431532H	95	431633H	455	431750H	308
430883	431	430966	110	431356H	410	431533H	96	431634H	455	431751H	308
430884	431	430967	110	431357H	410	431534H	96	431635H	455	431752H	308
430885	431	430968	110	431358H	410	431535H	96	431636H	455	431753H	308
430886	431	430977	119, 298	431359H	410	431536H	96	431637H	455	431754H	308
430887	431	430978	119, 298	431363H	410	431537H	96	431638H	455	431755H	308
430888	431	430979	119, 298	431364H	410	431538H	96	431639H	455	431756H	309
430889	431	430984H	95	431365H	410	431539H	96	431640H	455	431757H	309
430890	431	430985H	95	431366H	410	431540H	96	431641H	455	431762H	309
430891	431	430986H	95	431367H	410	431541H	96	431642H	455	431763H	309
430892	431	430987H	95	431368H	410	431542H	96	431643H	455	431765H	309
430893	431	430988H	95	431369H	410	431543H	96	431644H	455	431785H	309
430894	431	430989H	95	431370H	410	431544H	96	431645H	455	431786H	309
430895	431	430990H	95	431371H	410	431545H	96	431647H	480	431787H	309
430896	431	430991H	95	431372H	410	431546H	97	431648H	480	431794H	309
430897	431	430993	118, 298	431373H	410	431547H	97	431649H	480	431797H	309
430898	431	430995	119, 298	431374H	410	431548H	97	431650H	480	431801H	307
430899	431	430996	119, 298	431380	404	431549H	97	431651H	480	431802H	307
430900	431	430997	119, 298	431381	404	431550H	97	431652H	480	431803H	307
430901	118	431006	110	431382	404	431551H	97	431653H	480	431804H	307
430902	118	431007	110	431383	404	431552H	97	431654H	480	431805H	307
430903	118	431008	110	431384	404	431553H	97	431655H	480	431806H	307
430904	118	431009	110	431385	404	431554H	97	431656H	480	431807H	307
430905	118	431020	430	431386	404	431555H	97	431657H	480	431808H	307
430906	118	431021	430	431387	404	431556H	97	431658H	480	431809H	307
430907	118	431022	430	431388	404	431557H	98	431659H	480	431810H	307
430908	118	431023	430	431389	404	431558H	98	431660H	480	431811H	307
430909	118	431024	430	431390	404	431559H	98	431661H	480	431817H	307
430910	118	431025	430	431391	404	431560H	98	431662H	480	431818H	307
430911	118	431026	430	431392	404	431561H	98	431663H	480	431819H	307
430912	118	431027	431	431393	404	431562H	98	431664H	480	431820H	307
430913	118	431028	431	431394	404	431563H	98	431665H	480	431821H	307
430914	118	431029	431	431395H	410	431564H	98	431666H	480	431822H	307
430915	118	431030	431	431396H	410	431565H	98	431667H	480	431823H	307
430916	118	431031	431	431397H	410	431566H	98	431668H	480	431824H	307
430917	118	431045	118	431398H	410	431567H	99	431669H	480	431825H	307
430918	118	431046	118	431480	45	431576H	94	431670H	481	431826H	307
430919	118	431047	118	431481	45	431576H-TF	94	431671H	481	431827H	307
430920	118	431048	118	431482	45	431577H	94	431672H	481	431828H	307
430921	118	431049	118	431483	45	431577H-TF	94	431673H	481	431829H	308
430922	118	431111H	287	431484	45	431578H	94	431674H	481	431830H	308
430923	118	431112H	287	431485	45	431578H-TF	94	431675	481	431831H	308
430924	118	431113H	287	431486	45	431579H	94	431676	481	431832H	308
430925	118	431114H	287	431487	45	431579H-TF	94	431677H	480	431833H	308
430926	119	431115H	287	431488	45	431580H	94	431678H	480	431834H	308

Article No.	Page(s)	Article No.	Page(s)	Article No.	Page(s)	Article No.	Page(s)	Article No.	Page(s)	Article No.	Page(s)
431835H	308	433408	194	433855	194	435317H	466	435455H-TF	464	435603H	75
431836H	308	433410	194	433856	194	435318H	466	435455H-TK	465	435604H	75
431837H	308	433411	194	433891	486	435319H	466	435456H	464	435605H	75
431838H	308	433412	194	434194	298	435320H	466	435456H-TF	464	435606H	75
431839H	308	433430	194	434216	200	435321H	466	435456H-TK	465	435607H	75
431840H	308	433432	194	434217	200	435322H	466	435457H	464	435608H	75
431841H	308	433434	194	434218	200	435323H	466	435457H-TF	464	435609H	75
431842H	308	433436	194	434219	200	435324H	466	435457H-TK	465	435610H	75
431843H	308	433438	194	434220	200	435372H	463	435458H	464	435611H	75
431844H	308	433440	194	434221	200	435373H	463	435458H-TF	464	435612H	75
431845H	308	433442	194	434222	200	435374H	463	435458H-TK	465	435613H	75
431846H	308	433660	194	434223	200	435375H	463	435459H	464	435614H	75
431847H	308	433661	194	434224	200	435376H	463	435459H-TF	464	435615H	75
431848H	308	433662	194	434225	200	435377H	463	435459H-TK	465	435616H	75
431849H	308	433664	194	434226	200	435378H	463	435460H	464	435617H	75
431850H	308	433665	194	434227	200	435379H	463	435461H	464	435618H	75
431851H	308	433666	194	434228	200	435380H	463	435462H	464	435619H	75
431852H	309	433671	486	434229	200	435381H	463	435463H	464	435620H	75
431853H	309	433672	486	434230	200	435382H	463	435464H	464	435621H	75
431854H	309	433673	486	434231	200	435383H	463	435465H	464	435622H	75
431855H	309	433674	486	434232	200	435384H	463	435466H	464	435623H	75
431856H	309	433678	487	434233	200	435385H	463	435467H	464	435624H	75
431857H	309	433679	487	434234	200	435386H	463	435468H	464	435625H	75
431864H	309	433680	487	434235	200	435387H	463	435468H-TF	464	435626H	75
431865H	309	433681	487	434236	200	435397H	463	435468H-TK	465	435627H	75
431866H	309	433685	487	434237	200	435398H	463	435469H	464	435628H	75
431867H	309	433686	487	434238	200	435399H	463	435469H-TF	464	435629H	75
431868H	309	433687	487	434239	200	435400H	463	435469H-TK	465	435630H	75
431869H	309	433688	487	434240	200	435401H	463	435470H	464	435631H	75
431873H	307	433692	139	434241	200	435402H	463	435470H-TF	464	435632H	75
431874H	307	433693	139	434248	201	435403H	463	435470H-TK	465	435633H	75
431875H	307	433694	139	434249	201	435404H	463	435471H	464	435634H	75
431876H	307	433695	139	434250	201	435409H	463	435471H-TF	464	435635H	75
431877H	307	433696	139	434251	201	435410H	463	435471H-TK	465	435636H	75
431887H	309	433697	139	434252	201	435411H	463	435472H	464	435637H	75
431893H	309	433701	487	434253	201	435412H	463	435472H-TF	464	435638H	75
431894H	309	433702	487	434256	200	435413H	463	435472H-TK	465	435639H	75
431913	207	433703	487	434328	200	435414H	463	435473H	464	435640H	75
431914	207	433704	487	434330	200	435415H	463	435473H-TF	464	435641H	75
431915	207	433730	194	434332	200	435416H	463	435473H-TK	465	435642H	75
431919H	207	433731	194	434334	200	435417H	463	435474H	464	435643H	75
431920	207	433732	194	434336	200	435418H	463	435474H-TF	464	435644H	75
431921	207	433733	194	434342	201	435419H	463	435474H-TK	465	435645H	75
431922	207	433734	194	434344	201	435420H	463	435475H	464	435646H	75
431965H	480	433735	194	434432	487	435421H	463	435475H-TF	464	435647H	75
431966H	480	433756	139	434433	487	435422H	463	435475H-TK	465	435648H	75
431967H	480	433757	139	434434	487	435423H	463	435476H	464	435649H	75
432027	201	433758	139	434435	487	435424H	463	435477H	464	435650H	75
432028	201	433770	486	434976	200	435428H	463	435478H	464	435651H	75
432029	201	433771	486	434977	200	435428H-TK	465	435479H	464	435652H	75
432030	201	433772	486	434978	200	435429H	463	435480H	464	435653H	75
432033	201	433773	486	434979	200	435429H-TK	465	435481H	464	435654H	75
432034	201	433778	486	434980	201	435430H	463, 465	435482H	464	435655H	75
432035	201	433779	486	434981	201	435431H	463	435483H	464	435656H	75
432036	201	433780	486	434983H	45	435431H-TK	465	435484H	465	435657H	75
432039	201	433781	486	434984H	45	435432H	463	435485H	465	435658H	75
432040	201	433786	486	434985H	45	435432H-TK	465	435486H	465	435659H	75
432041	201	433787	486	434986H	455	435433H	463	435487H	465	435660H	75
432042	201	433789	486	434987H	455	435433H-TK	465	435488H	465	435661H	75
432045	201	433793	486	434988H	455	435434H	463	435489H	465	435662H	75
432046	201	433794	486	434989H	455	435434H-TK	465	435490H	465	435663H	75
432047	201	433795	486	435026	200	435435H	463	435491H	465	435664H	75
432048	201	433796	486	435027	200	435435H-TK	465	435492H	466	435665H	75
432292	298	433802	194	435028	200	435436H	464	435493H	466	435666H	75
432293	298	433803	194	435029	200	435437H	464	435494H	466	435667H	75
432294	298	433804	194	435301H	463	435438H	464	435495H	466	435668H	75
432323	455	433806	194	435302H	463	435439H	464	435496H	466	435669H	75
432324	455	433807	194	435303H	463	435440H	464	435497H	466	435670H	75
432325	455	433808	194	435304H	463	435441H	464	435498H	466	435671H	75
432326	455	433817	194	435305H	463	435442H	464	435499H	466	435672H	75
432335H	454	433819	194	435306H	463	435443H	464	435569H	66	435673H	75
432336H	454	433821	194	435307H	463	435452H	464	435570H	67	435674H	75
432337H	454	433823	194	435308H	463	435452H-TF	464	435571H	67	435675H	75
432338H	454	433841	486	435309H	466	435452H-TK	465	435572H	67	435676H	75
432805-HKS	194	433842	486	435310H	466	435453H	464	435573H	67	435677H	75
432805-IE	194	433843	486	435311H	466	435453H-TF	464	435574H	67	435678H	75
433402	194	433844	486	435312H	466	435453H-TK	465	435575H	67	435679H	75
433403	194	433850	194	435313H	466	435454H	464	435576H	69	435680H	75
433404	194	433851	194	435314H	466	435454H-TF	464	435577H	69	435681H	75
433406	194	433852	194	435315H	466	435454H-TK	465	435601H	75	435682H	75
433407	194	433854	194	435316H	466	435455H	464	435602H	75	435683H	75













Article No.	Page(s)	Article No.	Page(s)
910-2032H	364	920-2036H	364
910-2033H	364	920-2037H	364
910-2034H	364	920-2038H	364
910-2035H	364	920-2039H	364
910-2036H	364	920-2040H	364
910-2037H	364	920-2111H	362
910-2038H	364	920-2112H	362
910-2039H	364	920-2113H	362
910-2040H	364	920-2114H	362
910-2111H	362	920-2115H	362
910-2112H	362	920-2116H	362
910-2113H	362	920-2117H	362
910-2114H	362	920-2118H	362
910-2115H	362	920-2119H	362
910-2116H	362	920-2120H	362
910-2117H	362	926-37080	167
910-2118H	362	926-37081	167
910-2119H	362	926-37082	167
910-2120H	362	926i-27180H	166
918-37080	167	926i-27181H	166
918-37081	167	926i-27182H	166
918-37082	167	926i-32020H	164
918i-27180H	166	926i-32050H	164
918i-27181H	166	926i-32080H	165
918i-27182H	166	926i-32100H	165
918i-32020H	164	926i-34020H	167
918i-32050H	164	926i-34090H	165
918i-32080H	165	926i-38110H	164
918i-32100H	165	926i-42550HK	164
918i-34020H	167	926i-42580HK	165
918i-34090H	165	929R-1100	221
918i-34306H	167	929R-1110	221
918i-38110H	164	929R-4035	221
918i-42550HK	164	948D-1010	291
918i-42580HK	165	948D-1630	291
91i-32020H	153	950D-1010	291
91i-32025H	155	950D-1630	291
91i-32027H	155	980-2003H	362
91i-32050H	153	980-2007H	362
91i-32055H	155	980-2011H	362
91i-32057H	155	980-2015H	362
91i-38110H	153	980-2019H	364
91i-38115H	155	980-2023H	364
91i-38116H	155	980-2027H	364
91i-38117H	155	980-2031H	364
91i-38118H	155	980-2039H	364
920-2001H	362	980-2111H	362
920-2002H	362	980-2118H	362
920-2003H	362	980-2120H	362
920-2004H	362		
920-2005H	362		
920-2006H	362		
920-2007H	362		
920-2008H	362		
920-2009H	362		
920-2010H	362		
920-2011H	362		
920-2012H	362		
920-2013H	362		
920-2014H	362		
920-2015H	362		
920-2016H	362		
920-2017H	364		
920-2018H	364		
920-2019H	364		
920-2020H	364		
920-2021H	364		
920-2022H	364		
920-2023H	364		
920-2024H	364		
920-2025H	364		
920-2026H	364		
920-2027H	364		
920-2028H	364		
920-2029H	364		
920-2030H	364		
920-2031H	364		
920-2032H	364		
920-2033H	364		
920-2034H	364		
920-2035H	364		

Model	Series	Page(s)	Model	Series	Page(s)	Model	Series	Page(s)
<b>ø 1 cm / 3/8 Inch</b>			<b>7 x 30 cm / 2 13/16 x 12 Inch</b>					
Loop		256	Area Pro.		50	Strata		456
<b>1 x 20 cm / 3/8 x 8 Inch</b>			Basis 3		111	Unique		482
Basis 1		107	<b>7 x 60 cm / 2 13/16 x 24 Inch</b>			Valley		488
<b>2.5 x 2.5 cm / 1 x 1 Inch</b>			Alcina		38	<b>10 x 90 cm / 4 x 36 Inch</b>		
Amano		46	Area Pro.		50	Cedra		132
Fresh		222	Aruba		78	<b>12.5 x 12.5 cm / 5 x 5 Inch</b>		
Karl		236	Basis Pro		114	Ascona		86
Marble & More		284	Cedra		132	Chroma		140
Ocean		316	Emotion		190	Chroma non-slip		150
Pattern		322	Evalia		202	Chroma unglazed		160
Plural non-slip		358	Factory		208	Quarzit		372
Plural unglazed		366	Like		246	<b>12.5 x 25 cm / 5 x 10 Inch</b>		
Senja Pure		386	Lounge		264	Area Pro.		50
<b>ø 2 cm / 6/8 Inch</b>			Nova		302	Ascona		86
Loop		256	Sento		392	Chroma		140
<b>4 x 60 cm / 1 5/8 x 24 Inch</b>			Sierra		400	Chroma non-slip		150
Area Pro.		50	Skill		406	Chroma unglazed		160
Mandalay		274	Solid Ground		412	Craft		172
Strata		456	Solid Rock		424	Ferrum		218
<b>4.5 x 20 cm / 1 13/16 x 8 Inch</b>			Stone Duo		438	Natural Ceramics		288
Basis 1		107	Stories		446	Ocean		316
<b>5 x 5 cm / 2 x 2 Inch</b>			Strata		456	Quarzit		372
Alcina		38	Trio		472	<b>12.5 x 50 cm / 5 x 20 Inch</b>		
Area Pro.		50	Unique		482	Chroma		140
Ascona		86	Valley		488	Plural		338
Basic Stone		100	<b>7.2 x 60 cm / 2 7/8 x 24 Inch</b>			<b>12.5 x 100 cm / 5 x 40 Inch</b>		
Basis 2		110	Area Pro.		50	Plural		338
Basis 3		111	Strata		456	<b>15 x 15 cm / 6 x 6 Inch</b>		
Basis Pro		114	<b>7.2 x 120 cm / 2 7/8 x 48 Inch</b>			Area Pro.		50
Cedra		132	Area Pro.		50	Ascona		86
Evalia		202	Strata		456	Basis 1		107
Factory		208	<b>7.2 x 145 cm / 2 7/8 x 58 Inch</b>			Basis 2		110
Fresh		222	Area Pro.		50	Basis 3		111
Like		246	Strata		456	Basis Pro		114
Lounge		264	<b>7.5 x 25 cm / 3 1/8 x 10 Inch</b>			Emotion		190
Nova		302	Aruba		78	Nova		302
Pattern		322	<b>7.9 x 25 cm / 3 1/8 x 10 Inch</b>			Pattern		322
Plural		338	Chroma unglazed		160	Plural		338
Plural non-slip		358	<b>8 x 60 cm / 3 3/16 x 24 Inch</b>			Plural unglazed		366
Plural unglazed		366	Concrete		168	Quarzit		372
Quarzit		372	<b>8.45 x 33 cm / 3 13/32 x 13 13/64 Inch</b>			Savona		380
Savona		380	Mando		278	Trio		472
Senja Pure		386	<b>10 x 10 cm / 4 x 4 Inch</b>			<b>15 x 30 cm / 6 x 12 Inch</b>		
Sento		392	Area Pro.		50	Basis 1		107
Sierra		400	Basis 2		110	Plural		338
Solid Rock		424	Basis 3		111	<b>15 x 60 cm / 6 x 24 Inch</b>		
Stone Duo		438	Emotion Grip		196	Area Pro.		50
Stories		446	Karl		236	Basis Pro		114
Strata		456	Pattern		322	Emotion		190
Trio		472	Plural		338	Nova		302
Unique		482	Plural non-slip		358	Pizarro		334
Valley		488	Plural unglazed		366	Solid Ground		412
<b>5 x 10 cm / 2 x 4 Inch</b>			Strata		456	Solid Rock		424
District		182	<b>10 x 15 cm / 4 x 6 Inch</b>			Strata		456
<b>5 x 15 cm / 2 x 6 Inch</b>			Basis 3		111	Unique		482
Solid Ground		412	<b>10 x 20 cm / 4 x 8 Inch</b>			Valley		488
<b>5 x 60 cm / 2 x 24 Inch</b>			Area Pro.		50	<b>15 x 90 cm / 6 x 36 Inch</b>		
Solid Ground		412	Basis 3		111	Oak		310
Solid Rock		424	Emotion Grip		196	<b>15.4 x 15.4 cm / 6 3/16 x 6 3/16 Inch</b>		
Unique		482	Plural		338	Orientation Aids for the Blind		122
Valley		488	<b>10 x 25 cm / 4 x 10 Inch</b>			<b>20 x 20 cm / 8 x 8 Inch</b>		
<b>6 x 50 cm / 2 3/8 x 20 Inch</b>			Ascona		86	Area Pro.		50
Ascona		86	District		182	Basis 1		107
Quarzit		372	Karl		236	Basis 2		110
<b>6 x 60 cm / 2 3/8 x 24 Inch</b>			<b>10 x 30 cm / 4 x 12 Inch</b>			Basis 3		111
Ascona		86	Area Pro.		50	Emotion Grip		196
Oak		310	Basis Pro		114	Pattern		322
Quarzit		372	Emotion Grip		196	Plural		338
Savona		380	Strata		456	Plural non-slip		358
Streetlife Metallic		468	<b>10 x 50 cm / 4 x 20 Inch</b>			Plural unglazed		366
Walden		494	Ascona		86	<b>20 x 25 cm / 8 x 10 Inch</b>		
<b>6.2 x 25 cm / 2 1/2 x 10 Inch</b>			<b>10 x 60 cm / 4 x 24 Inch</b>			Basis 1		107
Chroma		140	Area Pro.		50	<b>20 x 40 cm / 8 x 16 Inch</b>		
Chroma unglazed		160	Ascona		86	Basis 1		107
Craft		172	Basis Pro		114	Plural		338
Ocean		316	Cedra		132	<b>20 x 60 cm / 8 x 24 Inch</b>		
<b>6.2 x 50 cm / 2 1/2 x 20 Inch</b>			Nova		302	Valley		488
Craft extended		178	Quarzit		372	<b>20 x 120 cm / 8 x 48 Inch</b>		
<b>7 x 20 cm / 2 13/16 x 8 Inch</b>			Solid Rock		424	Walden		494
Basis 3		111				<b>24.3 x 43.8 cm / 10 x 18 Inch</b>		
						Alcina		38

# 512 Index according to models

Model	Series	Page(s)
<b>25 x 8.9 cm / 10 x 3 1/2 Inch</b>		
	Eladuct + KerAion Ela 10 .6 . . . . .	186
<b>25 x 12.5 cm / 10 x 5 Inch</b>		
	Basis 4 . . . . .	113
	Eladuct + KerAion Ela 10 .6 . . . . .	186
	Ferrum . . . . .	218
<b>25 x 15.6 cm / 10 x 6 1/4 Inch</b>		
	Ferrum . . . . .	218
<b>25 x 25 cm / 10 x 10 Inch</b>		
	Area Pro . . . . .	50
	Ascona . . . . .	86
	Chroma . . . . .	140
	Chroma non-slip . . . . .	150
	Chroma unglazed . . . . .	160
	Natural Ceramics . . . . .	288
	Quarzit . . . . .	372
<b>25 x 33 cm / 10 x 13 Inch</b>		
	Basis 1 . . . . .	107
<b>25 x 50 cm / 10 x 20 Inch</b>		
	Area Pro . . . . .	50
	Ascona . . . . .	86
	Chroma . . . . .	140
	Chroma unglazed . . . . .	160
	Plural . . . . .	338
	Quarzit . . . . .	372
<b>27.8 x 20 cm / 11 x 8 Inch</b>		
	Emotion Grip . . . . .	196
<b>28 x 145 cm / 11 3/16 x 58</b>		
	Area Pro . . . . .	50
	Ascona . . . . .	86
	Nova . . . . .	302
	Quarzit . . . . .	372
	Solid Ground . . . . .	412
	Strata . . . . .	456
<b>30 x 8.7 cm / 12 x 3 1/2 Inch</b>		
	Eladuct + KerAion Ela 10.6 . . . . .	186
<b>30 x 30 cm / 12 x 12 Inch</b>		
	Area Pro . . . . .	50
	Basis 3 . . . . .	111
	Basis Pro . . . . .	114
	Orientation Aids for the Blind . . . . .	122
	Emotion . . . . .	190
	Emotion Grip . . . . .	196
	New Market . . . . .	292
	Plural . . . . .	338
	Sento . . . . .	392
	Sierra . . . . .	400
	Stone Duo . . . . .	438
	Stories . . . . .	446
	Strata . . . . .	456
	Unique . . . . .	482
	Valley . . . . .	488
<b>30 x 35 cm / 12 x 14 Inch</b>		
	Oak . . . . .	310
<b>30 x 44.5 cm / 12 x 18 Inch</b>		
	Like . . . . .	246
<b>30 x 60 cm / 12 x 24 Inch</b>		
	Alcina . . . . .	38
	Area Pro . . . . .	50
	Aruba . . . . .	78
	Ascona . . . . .	86
	Basis 1 . . . . .	107
	Basis 1+ . . . . .	109
	Basis 2 . . . . .	110
	Basis 3 . . . . .	111
	Basis Pro . . . . .	114





Model	Series	Page(s)
	Cedra . . . . .	132
	Concrete . . . . .	168
	Emotion . . . . .	190
	Evalia . . . . .	202
	Factory . . . . .	208
	Like . . . . .	246
	Lounge . . . . .	264
	Mandalay . . . . .	274
	New Market . . . . .	292
	Nivella . . . . .	300
	Nova . . . . .	302
	Pizarro . . . . .	334
	Plural . . . . .	338
	Plural non-slip . . . . .	358
	Plural unglazed . . . . .	366
	Quarzit . . . . .	372
	Savona . . . . .	380
	Senja Pure . . . . .	386
	Sento . . . . .	392
	Sierra . . . . .	400
	Skill . . . . .	406
	Solid Ground . . . . .	412
	Solid Rock . . . . .	424
	Stone Concept . . . . .	432
	Stone Duo . . . . .	438
	Stories . . . . .	446
	Strata . . . . .	456
	Trio . . . . .	472
	Unique . . . . .	482
	Valley . . . . .	488
<b>30 x 90 cm / 12 x 36 Inch</b>		
	Alcina . . . . .	38
	Area Pro . . . . .	50
	Aruba . . . . .	78
	Basis 1 . . . . .	107
	Basis 1+ . . . . .	109
	Cedra . . . . .	132
	Evalia . . . . .	202
	Factory . . . . .	208
	Lounge . . . . .	264
	Oak . . . . .	310
	Senja Pure . . . . .	386
	Trio . . . . .	472
<b>30 x 120 cm / 12 x 48 Inch</b>		
	Factory . . . . .	208
	Oak . . . . .	310
	Skill . . . . .	406
	Streetlife Metallic . . . . .	468
	Trio . . . . .	472
<b>31 x 30 cm / 12 13/64 x 12 Inch</b>		
	Craft extended . . . . .	178
<b>31 x 145 cm / 12 3/8 x 58 Inch</b>		
	Area Pro . . . . .	50
	Ascona . . . . .	86
	Nova . . . . .	302
	Quarzit . . . . .	372
	Solid Ground . . . . .	412
	Strata . . . . .	456
<b>35 x 100 cm / 14 x 40 Inch</b>		
	Basis 1 . . . . .	107
	Bliss . . . . .	128
	Mando . . . . .	278
	Sento . . . . .	392
	Stories . . . . .	446
<b>40 x 120 cm / 16 x 48 Inch</b>		
	Oak . . . . .	310

Model	Series	Page(s)
<b>50 x 25 cm / 20 x 10 Inch</b>		
	Area Pro . . . . .	50
	Ascona . . . . .	86
	Quarzit . . . . .	372
<b>50 x 100 cm / 20 x 40 Inch</b>		
	Ascona . . . . .	86
	Plural . . . . .	338
<b>60 x 60 cm / 24 x 24 Inch</b>		
	Alcina . . . . .	38
	Area Pro . . . . .	50
	Aruba . . . . .	78
	Ascona . . . . .	86
	Basis Pro . . . . .	114
	Eladuct + KerAion Ela 10 .6 . . . . .	186
	Emotion . . . . .	190
	Evalia . . . . .	202
	Factory . . . . .	208
	KerAion OP Special Glazes . . . . .	242
	Like . . . . .	246
	Lounge . . . . .	264
	New Market . . . . .	292
	Nova . . . . .	302
	Quarzit . . . . .	372
	Savona . . . . .	380
	Sento . . . . .	392
	Skill . . . . .	406
	Solid Ground . . . . .	412
	Solid Rock . . . . .	424
	Stone Duo . . . . .	438
	Stories . . . . .	446
	Strata . . . . .	456
	Streetlife Metallic . . . . .	468
	Trio . . . . .	472
	Unique . . . . .	482
	Valley . . . . .	488
<b>60 x 120 cm / 24 x 48 Inch</b>		
	Area Pro . . . . .	50
	Aruba . . . . .	78
	Factory . . . . .	208
	Lounge . . . . .	264
	Nova . . . . .	302
	Oak . . . . .	310
	Savona . . . . .	380
	Sento . . . . .	392
	Skill . . . . .	406
	Solid Ground . . . . .	412
	Solid Rock . . . . .	424
	Stone Duo . . . . .	438
	Strata . . . . .	456
	Streetlife Metallic . . . . .	468
	Trio . . . . .	472
	Unique . . . . .	482
	Valley . . . . .	488
<b>80 x 80 cm / 32 x 32 Inch</b>		
	Like . . . . .	246
<b>90 x 90 cm / 36 x 36 Inch</b>		
	Area Pro . . . . .	50
<b>100 x 100 cm / 40 x 40 Inch</b>		
	Stories . . . . .	446
<b>120 x 120 cm / 48 x 48 Inch</b>		
	Like . . . . .	246
	Lounge . . . . .	264
	Solid Ground . . . . .	412
	Trio . . . . .	472



Model No.	Page(s)	Model No.	Page(s)	Model No.	Page(s)	Model No.	Page(s)
1010	291	2821	177	37080	167	54422	221
1100	221	32020H	153, 154, 157, 164, 377	37081	167	54423	221
1110	189, 221	32025H	155, 158	37082	167	61061HK	379
12020H	146, 148, 149	32027H	155, 158	38110	113	6635	127
12023H	147	32050H	153, 154, 157, 164	38110H	153, 154, 157, 164, 377	6636	127
12050H	146, 148, 149	32055H	155, 158	38115H	155, 158	703	351, 353
12053H	147	32057H	155, 158	38116H	155, 158	7161H	377, 384
1630	291	32080H	165	38117H	155, 158	730	352, 354
18120	113	32100H	165	38118H	155, 158	760	352, 354
18120H	146, 148, 149	332050HK	377	4000	189	8110	113
18123H	147	34020H	167	4003	189	9215	181
18124H	147	34090H	165, 377	4004	189	B200HK	377, 384
18210H	146, 148, 149	341550HK	351, 353	4035	221	B600HK	245, 377, 384
18213H	147	342030H	377, 384	41550HK	146, 148, 149	B611HK	378, 384
18214H	147	342550HK	352, 354, 377	42550HK	146, 148, 149, 164	B612HK	378
2120	177	342555HK	378	42580HK	165	B670HK	384
2240	177	342557HK	378	53150	379	B700HK	471
2250	177	342580HK	377	53151	379	B710HK	471
2270	177	34306H	167	53159	379	B729HK	471
2280	177	352010HK	351, 353	53320	379	B770HK	471
2290	181	352050HK	352, 354	53321	379	B773HK	378
2320	181	37040	189	53322	379	B774HK	378
27180H	166	37042	189	53323	379	K100	189
27181H	166	37043	189	54420	221		
27182H	166	37044	189	54421	221		

Agrob Buchtal offers tiles with overglazed edges in many series. In the case of **split tiles**, overglazed or overglazed rounded edges are available upon request according to the following model number system:

					
Last figure 0 of model no. to be replaced by ...	...1 = Short edge	...2 = Longitudinal edge	...3 = Corner left	...4 = Corner right	overglazed edges
	...5 = Short edge	...6 = Longitudinal edge	...7 = Corner left	...8 = Corner right	overglazed rounded edges (bullnoses)

**Example: Standard model no. 18120 = 244 x 119 x 6 mm,  
model no. 18123 = overglazed corner left**

## Area Pro

Color	similar to NCS no.	similar to RAL no.	Color Shade Variation
anthracite	S7502-B	7024	V2
basalt	S7005-B80G	180 4005	V2
pebble	S3502-Y	7030	V2
stone	S2502-Y	100 7005	V2
sand-white	S1502-Y50R	080 8005	V2
sand-grey	S1502-Y50R	080 7005	V2
sand	S5005-Y20R	075 5010	V2
nutmeg	S7005-Y50R	060 4005	V2
platinum	S0500-N	8500	V2
sand-beige	S1005-Y50R	060 8010	V2
brick	S7010-Y30R	060 4010	V2
clay	S8010-Y50R	050 3010	V2

## Chroma und Plural

Color	similar to NCS no.	similar to RAL no.	Lightness Value Y
neutral 1 (Chroma unglazed)	S9000-N	9017	3
neutral 1	8000	7016	6
neutral 2	S7500-N	7015	9
neutral 3	S6500-N		15
neutral 4	S6000-N	7037	18
neutral 5	S5502-B	7046	21
neutral 6	S4502-B	7045	25
neutral 7	S4000-N	7004	33
neutral 8	S2502-B		46
neutral 9	S1502-R50B		65
neutral 10 (Chroma, Plural)	S1000-N	9003	76
neutral 10 (Chroma unglazed)	0502-Y	9001	66
neutral 10 (white glossy)	S1500	9003	70
active azure	S5030-R80B	5000	9
light azure	S2030-R80B		37
medium azure	S4030-R90B		21
dark azure	S4040-R90B	5007	13
active blue	S6030-R90B		7
light blue	S1510-R80B		60
medium blue	S2020-R80B		40
dark blue	S4030-R80B		17
active turquoise	S4030-B50G	6033	22
light turquoise	S1010-B50G		63
medium turquoise	S2020-B30G		44
dark turquoise	S4020-B30G		26
active green	S3050-G50Y		26
light green	S0510-G		69
medium green	S1515-G20Y	6019	53
dark green	S3020-G10Y	6021	31
active yellow	S3050-Y10R		32
light yellow	S1010-Y10R	1015	69
medium yellow	S2030-Y10R		50
dark yellow	S2050-Y20R		33
active ochre	S3050-Y40R		20
light ochre	S2030-Y20R		48
medium ochre	S3030-Y30R		36
dark ochre	S4030-Y50R		21
active salmon	S4040-Y70R		15
light salmon	S1515-Y50R		51
medium salmon	S2020-Y50R		39
dark salmon	S3040-Y60R		23
active oxide red	S4050-Y90R		10
light oxide red	S2010-Y80R		46
medium oxide red	S3020-Y80R		25
dark oxide red	S5020-Y80R		15
active stone grey	S5030-Y90R		9
light stone grey	S2502-R		46
medium stone grey	S3502-R	7036	34
dark stone grey	S6005-Y80R		15
active sand grey	S7010-Y90R		8
light sand grey	S1502-Y		56
medium sand grey	S3005-Y50R		35
dark sand grey	S6010-Y50R		14

## Special colors

Color	similar to NCS no.	similar to RAL no.	Lightness Value Y
apple-green	S1060-G40Y		39
medium brown	S5020-Y50R	060 50 20	17
grey	S3502-Y	100 70 05	32
intense blue	6040-R70B		1
contrasting red (Chroma non-slip B)	S2050-Y90R	3017	14
contrasting red (Chroma non-slip C)	S2060-Y90R	3018	15
contrasting red (Chroma)	S2570-Y90R	3002	10
natural white	2005-Y20R	7032	51
orange	S2060-Y50R	2010	24
medium sand-beige	S1010-Y20R	1001	44
violet	S5020-R50B	4001	13
lemon-yellow	1070-Y	1016	52

## Intense colors

Color	similar to NCS no.	similar to RAL no.	Lightness Value Y
violet	S3555-R60B	300 30 25	11
berry red	S4050-R20B	360 30 35	11
brown red	S2570-Y90R	3003	10
fire red	S1080-R	3002	14
signal orange	S1070-Y30R	060 70 70	39
sunshine yellow	S1070-Y	080 70 70	50
yellow green	S2050-G40Y	120 60 50	34
sea green	S4030-G	6000	21
blue green	S3040-B50G	190 50 25	23
cobalt blue	S4055-R70B	290 30 40	8

## KerAion Special Glazes for Operation Theatres

Color	similar to NCS no.	similar to RAL no.	Lightness Value Y
beige	0502-Y	1013	69
blue	0530-R90B		46
grey	3000-N	7038	47
green	2030-B70G	6027	36
light-grey	1502-G50Y	7047	58
white	0500-N	9003	78

The use of color as an architectural design means has gained increasing importance during the last years. Therefore, we provide you with a list of the relevant Agrob Buchtal design series in order to facilitate planning. It classifies the colors according to:

NCS = Natural Color System

(More detailed information can be obtained from: Scandinavian Color Institute AB, P.O. Box 49022 · S-10028 Stockholm · Phone +46/8/6174700 · Fax +46/8/6174747, Institut für Farbe – Brigitte Hartmann · Rotes Knie 6 · 74389 Cleebrohn Phone 07135/12742 · Fax 07135/12737)

RAL Color Chart

(More detailed information can be obtained from: RAL – Deutsches Institut für Gütesicherung und Kennzeichnung e.V. · Siegburger Straße 39 · D-53757 St. Augustin Phone +49 (0) 2241/1605-0 · Fax +49 (0) 2241/1605-11)

Lightness Value:

This figure (standard color value Y) describes the lightness of a color in comparison with an ideally white surface if illuminated under identical light conditions, i. e. same intensity, direction and quality. For an ideal white, which means that all the incident light is reflected, the value Y = 100 applies (black: Y = 0).

Please note that these classifications may only serve as an orientation aid. Original samples will be made available to you upon request.

The difference in lightness of two adjoining colored surfaces is called luminance contrast. By means of this value, one can determine whether a room design is rich in contrast, as it is required, for example, by DIN 32975 "Designing visual information in the public area for accessible use". In the following, you will find the relevant values for selected series. They result from the

respective lightness values, which are indicated as averaged values of individual measurements. We will be pleased to determine values for other products upon request.

Luminance contrast Series Area Pro										
		anthracite	basalt	pebble	stone	sand-white	sand-grey	sand	nutmeg	
<i>Lightness Value Y</i>		8	13	21	33	50	38	21	14	
anthracite	8	<b>0.00</b>	<b>0.23</b>	<b>0.44</b>	<b>0.60</b>	<b>0.72</b>	<b>0.64</b>	<b>0.44</b>	<b>0.24</b>	
basalt	13		<b>0.00</b>	<b>0.23</b>	<b>0.43</b>	<b>0.59</b>	<b>0.49</b>	<b>0.24</b>	<b>0.01</b>	
pebble	21			<b>0.00</b>	<b>0.22</b>	<b>0.41</b>	<b>0.29</b>	<b>0.01</b>	<b>0.22</b>	
stone	33				<b>0.00</b>	<b>0.21</b>	<b>0.08</b>	<b>0.21</b>	<b>0.42</b>	
sand-white	50					<b>0.00</b>	<b>0.14</b>	<b>0.40</b>	<b>0.58</b>	
sand-grey	38						<b>0.00</b>	<b>0.28</b>	<b>0.48</b>	
sand	21							<b>0.00</b>	<b>0.23</b>	
nutmeg	14								<b>0.00</b>	
platinum	58									
sand-beige	41									
brick	14									
clay	10									

Luminance contrast Series Ascona							
		shell	sand	pearl	stone	mud	graphite
<i>Lightness Value Y</i>		55	50	47	40	27	11
shell	55	<b>0.00</b>					
sand	50	<b>0.05</b>	<b>0.00</b>				
pearl	47	<b>0.08</b>	<b>0.03</b>	<b>0.00</b>			
stone	40	<b>0.16</b>	<b>0.11</b>	<b>0.08</b>	<b>0.00</b>		
mud	27	<b>0.34</b>	<b>0.30</b>	<b>0.27</b>	<b>0.19</b>	<b>0.00</b>	
graphite	11	<b>0.67</b>	<b>0.64</b>	<b>0.62</b>	<b>0.57</b>	<b>0.42</b>	<b>0.00</b>

Luminance contrast Series Basis Pro						
		anthracite	basalt	ash-brown	concrete-grey	sand-beige
<i>Lightness Value Y</i>		7	10	20	24	42
anthracite	7	<b>0.00</b>				
basalt	10	<b>0.14</b>	<b>0.00</b>			
ash-brown	20	<b>0.42</b>	<b>0.26</b>	<b>0.00</b>		
concrete-grey	24	<b>0.49</b>	<b>0.33</b>	<b>0.07</b>	<b>0.00</b>	
sand-beige	42	<b>0.66</b>	<b>0.53</b>	<b>0.29</b>	<b>0.22</b>	<b>0.00</b>

Luminance contrast Series Area Pro (continuation)

		platinum	sand-beige	brick	clay
<i>Lightness Value Y</i>		58	41	14	10
anthracite	8	<b>0.75</b>	<b>0.66</b>	<b>0.25</b>	<b>0.07</b>
basalt	13	<b>0.63</b>	<b>0.51</b>	<b>0.03</b>	<b>0.16</b>
pebble	21	<b>0.47</b>	<b>0.32</b>	<b>0.21</b>	<b>0.38</b>
stone	33	<b>0.28</b>	<b>0.11</b>	<b>0.41</b>	<b>0.55</b>
sand-white	50	<b>0.07</b>	<b>0.11</b>	<b>0.57</b>	<b>0.68</b>
sand-grey	38	<b>0.21</b>	<b>0.04</b>	<b>0.47</b>	<b>0.60</b>
sand	21	<b>0.46</b>	<b>0.31</b>	<b>0.21</b>	<b>0.38</b>
nutmeg	14	<b>0.62</b>	<b>0.50</b>	<b>0.01</b>	<b>0.17</b>
platinum	58	<b>0.00</b>	<b>0.18</b>	<b>0.62</b>	<b>0.72</b>
sand-beige	41		<b>0.00</b>	<b>0.49</b>	<b>0.62</b>
brick	14			<b>0.00</b>	<b>0.19</b>
clay	10				<b>0.00</b>

Luminance contrast Series Emotion (Floor)

		deep anthracite	basalt	mid-grey	light-beige
<i>Lightness Value Y</i>		7	19	32	46
deep anthracite	7	<b>0.00</b>			
basalt	19	<b>0.46</b>	<b>0.00</b>		
mid-grey	32	<b>0.64</b>	<b>0.25</b>	<b>0.00</b>	
light-beige	46	<b>0.74</b>	<b>0.42</b>	<b>0.18</b>	<b>0.00</b>

Luminance contrast Series Factory

		blue steel	asphalt	bronze grey	aluminium	lime
<i>Lightness Value Y</i>		13	14	16	33.5	51.5
blue steel	13	<b>0.00</b>				
asphalt	14	<b>0.04</b>	<b>0.00</b>			
bronze grey	16	<b>0.10</b>	<b>0.07</b>	<b>0.00</b>		
aluminium	33.5	<b>0.44</b>	<b>0.41</b>	<b>0.35</b>	<b>0.00</b>	
lime	51.5	<b>0.60</b>	<b>0.57</b>	<b>0.53</b>	<b>0.21</b>	<b>0.00</b>

Luminance contrast Series Nova									
		cream-beige	mid-brown	mid-grey	basalt	anthracite	creme-beige-multicolored	mid-grey-multicolored	anthracite-multicolored
<i>Lightness Value Y</i>		44	18	35	15	6	44	35	9
cream-beige	44	<b>0.00</b>	<b>0.42</b>	<b>0.11</b>	<b>0.49</b>	<b>0.76</b>	<b>0.00</b>	<b>0.11</b>	<b>0.66</b>
mid-brown	18		<b>0.00</b>	<b>0.32</b>	<b>0.09</b>	<b>0.50</b>	<b>0.42</b>	<b>0.32</b>	<b>0.33</b>
mid-grey	35			<b>0.00</b>	<b>0.40</b>	<b>0.71</b>	<b>0.11</b>	<b>0.00</b>	<b>0.59</b>
basalt	15				<b>0.00</b>	<b>0.43</b>	<b>0.49</b>	<b>0.40</b>	<b>0.25</b>
anthracite	6					<b>0.00</b>	<b>0.76</b>	<b>0.71</b>	<b>0.20</b>
creme-beige-multicolored	44						<b>0.00</b>	<b>0.11</b>	<b>0.66</b>
mid-grey-multicolored	35							<b>0.00</b>	<b>0.59</b>
anthracite-multicolored	9								<b>0.00</b>

Luminance contrast Series Quarzit						
		basalt-grey	quarz-grey	sand-beige	sepia-brown	white grey
<i>Lightness Value Y</i>		15	40	47	30	55
basalt-grey	15	<b>0.00</b>				
quarz-grey	40	<b>0.45</b>	<b>0.00</b>		<b>0.14</b>	
sand-beige	47	<b>0.52</b>	<b>0.08</b>	<b>0.00</b>	<b>0.22</b>	
sepia-brown	30	<b>0.33</b>			<b>0.00</b>	
white grey	55	<b>0.57</b>	<b>0.16</b>	<b>0.08</b>	<b>0.29</b>	<b>0.00</b>

Luminance contrast Series Savona						
		lime	beige	brown	grey	anthracite
<i>Lightness Value Y</i>		52	38	20	20	8
lime	52	<b>0.00</b>	<b>0.16</b>	<b>0.44</b>	<b>0.44</b>	<b>0.73</b>
beige	38		<b>0.00</b>	<b>0.31</b>	<b>0.31</b>	<b>0.65</b>
brown	20			<b>0.00</b>	<b>0.00</b>	<b>0.43</b>
grey	20			<b>0.00</b>	<b>0.00</b>	<b>0.43</b>
anthracite	8					<b>0.00</b>

Luminance contrast Series Strata									
		lava	volcano	stone	loam	clay	quarz	lime	pumice
<i>Lightness Value Y</i>		7.4	8.5	12.9	19.2	26.0	32.0	37.0	48.6
pumice	48.6	<b>0.74</b>	<b>0.70</b>	<b>0.58</b>	<b>0.43</b>	<b>0.30</b>	<b>0.21</b>	<b>0.14</b>	<b>0.00</b>
lime	37.0	<b>0.67</b>	<b>0.63</b>	<b>0.48</b>	<b>0.32</b>	<b>0.17</b>	<b>0.07</b>	<b>0.00</b>	
quarz	32.0	<b>0.62</b>	<b>0.58</b>	<b>0.43</b>	<b>0.25</b>	<b>0.10</b>	<b>0.00</b>		
clay	26.0	<b>0.56</b>	<b>0.51</b>	<b>0.34</b>	<b>0.15</b>	<b>0.00</b>			
loam	19.2	<b>0.44</b>	<b>0.39</b>	<b>0.20</b>	<b>0.00</b>				
stone	12.9	<b>0.27</b>	<b>0.21</b>	<b>0.00</b>					
volcano	8.5	<b>0.07</b>	<b>0.00</b>						
lava	7.4	<b>0.00</b>							

Luminance contrast Series Trio						
		slate black	mud grey	iron grey	cement grey	ivory white
<i>Lightness Value Y</i>		9.9	18.8	19.3	35.1	52.5
slate black	9.9	<b>0.00</b>				
mud grey	18.8	<b>0.31</b>	<b>0.00</b>			
iron grey	19.3	<b>0.32</b>	<b>0.01</b>	<b>0.00</b>		
cement grey	35.1	<b>0.56</b>	<b>0.30</b>	<b>0.29</b>	<b>0.00</b>	
ivory white	52.5	<b>0.68</b>	<b>0.47</b>	<b>0.46</b>	<b>0.20</b>	<b>0.00</b>

Luminance contrast Series Trio Terrazzo				
		terrazzo black	terrazzo red	terrazzo ivory
<i>Lightness Value Y</i>		13	19.1	43.5
terrazzo black	13	<b>0.00</b>		
terrazzo red	19.1	<b>0.19</b>	<b>0.00</b>	
terrazzo ivory	43.5	<b>0.54</b>	<b>0.39</b>	<b>0.00</b>

Luminance contrast Series Unique							
		anthracite	basalt	light-grey	beige	brown	mud
<i>Lightness Value Y</i>		6	17	36	45	18	30
anthracite	6	<b>0.00</b>					
basalt	17	<b>0.48</b>	<b>0.00</b>				
light-grey	36	<b>0.71</b>	<b>0.36</b>	<b>0.00</b>		<b>0.33</b>	<b>0.09</b>
beige	45	<b>0.76</b>	<b>0.45</b>	<b>0.11</b>	<b>0.00</b>	<b>0.43</b>	<b>0.20</b>
brown	18	<b>0.50</b>	<b>0.03</b>			<b>0.00</b>	
mud	30	<b>0.67</b>	<b>0.28</b>			<b>0.25</b>	<b>0.00</b>

Luminance contrast Series Valley					
		slate	pebble-grey	earth-brown	sand-beige
<i>Lightness Value Y</i>		9	33	10	51
slate	9	<b>0.00</b>			
pebble-grey	33	<b>0.57</b>	<b>0.00</b>	<b>0.53</b>	
earth-brown	10	<b>0.05</b>		<b>0.00</b>	
sand-beige	51	<b>0.70</b>	<b>0.21</b>	<b>0.67</b>	<b>0.00</b>





# European Quality Standards

Product Standards <small>(simplified and based on 20 x 20 cm (BIII), or 30 x 30 cm (BI))</small>	Extruded Ceramic Tiles DIN EN 14411		Dry-pressed Ceramic Tiles DIN EN 14411		Test Standards
	group A <sub>Ia</sub> + A <sub>Ib</sub> „Nature“   „Precision“	group A <sub>IIa</sub> - part 1 „Nature“   „Precision“	group B <sub>Ia</sub> + B <sub>Ib</sub>	group BIII	
<b>A) Dimensions + Surfaces</b>					
1. Length and Width	± 2 %   ± 1.0%	± 2 %   ± 1.25 %	± 0.6%	± 0.5%	DIN EN ISO 10545-2
2. Thickness	± 10 %   ± 10 %	± 10 %   ± 10 %	± 5 %	± 10 %	DIN EN ISO 10545-2
3. Straightness of Edges	± 0.6%   ± 0.5%	± 0.6%   ± 0.5%	± 0.5%	± 0.3%	DIN EN ISO 10545-2
4. Rectangularity	± 1.0%   ± 1.0%	± 1.0%   ± 1.0%	± 0.5%	± 0.5%	DIN EN ISO 10545-2
5. Surface Flatness					DIN EN ISO 10545-2
5.1 Curvature at Centre	± 1.5%   ± 0.5%	± 1.5%   ± 0.5%	± 0.5%	+ 0.5/-0.3%	DIN EN ISO 10545-2
5.2 Curvature at the Edges	± 1.5%   ± 0.5%	± 1.5%   ± 0.5%	± 0.5%	+ 0.5/-0.3%	DIN EN ISO 10545-2
5.3 Skewness	± 1.5%   ± 0.8%	± 1.5%   ± 0.8%	± 0.5%	± 0.5%	DIN EN ISO 10545-2
6. Surface Quality	at least 95%	at least 95%	at least 95 %	at least 95 %	DIN EN ISO 10545-2
7. Color Deviations	•	•	•	•	DIN EN ISO 10545-16
7.1 Color Shade Grading	•	•	•	•	Deutsche Steinzeug
8. Size Grading	•	•	•	•	Deutsche Steinzeug
<b>B) Physical Properties</b>				glazed	
1. Water Absorption <small>on average / max. individual value</small>	A <sub>Ia</sub> E ≤ 0.5%/0.6% A <sub>Ib</sub> 0.5% < E ≤ 3%/3.3%	≤ 6/6.5%	B <sub>Ia</sub> ≤ 0.5% B <sub>Ib</sub> ≤ 3%	> 10%	DIN EN ISO 10545-3
2. Modulus of Rupture <small>Value in brackets = min. individual value</small>	A <sub>Ia</sub> min. 28 (21) N/mm <sup>2</sup> A <sub>Ib</sub> min. 23 (18) N/mm <sup>2</sup>	min. 20 (18) N/mm <sup>2</sup>	B <sub>Ia</sub> min. 35 (32) N/mm <sup>2</sup> B <sub>Ib</sub> min. 30 (27) N/mm <sup>2</sup>	thkns. < 7.5mm: 15 N/mm <sup>2</sup> thkns. ≥ 7.5mm: 12 N/mm <sup>2</sup>	DIN EN ISO 10545-4
2.1. Breaking Strength ≥ 7.5 mm tickness	A <sub>Ia</sub> min. 1300 N A <sub>Ib</sub> min. 1100 N	at least 950 N	B <sub>Ia</sub> min. 1300 N B <sub>Ib</sub> min. 1100 N	at least 600 N	DIN EN ISO 10545-4
2.2. Break. Str. < 7.5 mm thickness	at least 600 N	at least 600 N	at least 700 N	at least 200 N	DIN EN ISO 10545-4
3. Resistance to Shock	•	•	•	•	DIN EN ISO 10545-5
4. Resistance to Deep Abrasion	≤ 275 mm <sup>3</sup>	≤ 393 mm <sup>3</sup>	≤ 175 mm <sup>3</sup>	–	DIN EN ISO 10545-6
5. Resistance to Glaze Abrasion	0-5	0-5	0-5	0-5	DIN EN ISO 10545-7
6. Max. Coefficient of Expansion	•	•	•	•	DIN EN ISO 10545-8
7. Thermal Shock Resistance	•	•	•	•	DIN EN ISO 10545-9
8. Moisture Expansion	< 0.001mm/m	< 0.001mm/m	appr. 0.001mm/m	appr. 0.01mm/m	DIN EN ISO 10545-10
9. Resistance to Glaze Cracking	required	required	required	required	DIN EN ISO 10545-11
10. Thermal Conductivity	appr. 1 W/mK	appr. 1 W/mK	appr. 1 W/mK	appr. 0.8 W/mK	Deutsche Steinzeug
11. Electrical Leakage Resistance	> 10 <sup>10</sup> Ohm <sup>3</sup>	> 10 <sup>10</sup> Ohm <sup>3</sup>	10 <sup>10</sup> Ohm	10 <sup>10</sup> Ohm	DIN EN 1081
12. Steam Diffusion Resistance	ca. μ 120.000	ca. μ 120.000	ca. μ 120.000	ca. μ 100.000	DIN EN ISO 12572
13. Resistance to Frost	required	not required, but met by Agrob Buchtal	required	–	DIN EN ISO 10545-12
14. Light an Color Fastness	•	•	•	•	DIN 51094
15. Luminance	acc. to specifications	acc. to specifications	acc. to specifications	acc. to specifications	Deutsche Steinzeug
16. Behaviour in Fire	A1/A1 <sub>fl</sub>	A1/A1 <sub>fl</sub>	A1/A1 <sub>fl</sub>	A1/A1 <sub>fl</sub>	DIN 4102/DIN EN 13501-1
<b>C) Chemical Properties<sup>2)</sup></b>					
1. Resistance to Chemicals	see test certificate	see test certificate	see test certificate	see test certificate	DIN EN ISO 10545-13
2. Resistance to Household Chemicals and Bath Water Additives	min. GB or UB	min. GB or UB	min. GB or UB	–	
3. Stain Resistance (glazed)	min. class 3	min. class 3	min. class 3	min. class 3	DIN EN ISO 10545-14
4. Lead and Cadmium Delivery	•	•	•	•	DIN EN ISO 10545-15
5. Hytect	see test certificate	see test certificate	see test certificate	see test certificate	Deutsche Steinzeug
<b>D) Slip resistance</b>					
1. Coefficient of Friction	•	•	•	–	E-DIN EN ISO 10545-17
1.1 Industrial Areas (BG) Trade Associations	Groups R9-13/V4-10	Groups R9-13/V4-10	Groups R9-13/V4-10	–	DIN EN 16165, Annex B DGUV-R 108-003 (BGR 181)
1.2 Barefoot Areas (BUK) German National Association of Accident Insurance Companies	Groups A/B/C	Groups A/B/C	Groups A/B/C	–	DIN EN 16165, Annex A DGUV-I 207-006 (GUV-I 8527)

1) Boxes marked according to size and color shade.  
 2) Hydrofluoric acid and its compounds excluded.  
 3) Exceptions:  
 KerAion ELA 10.6: Electrical Leakage Resistance 10<sup>6</sup> Ohm (DIN EN 1081)  
 Eladuct 10<sup>8</sup>

All references to as well as quotations from product and test standards are to be considered as information which is not binding. The latest versions apply.

### Deutsche Steinzeug tiles present better values than required by the standards.

In addition, they are construction biologically, ecologically, hygienically and bacteriologically safe; this is guaranteed through the choice of raw materials, method of processing and firing technique.

## Terms and Classification according to DIN EN 14411

All our tiles consist of natural raw materials such as clay, quartz sand and feldspars, which are processed, refined and fired. Depending on the application they are manufactured with a glazed (GL) or unglazed (UGL) surface. They can be classified in accordance with DIN EN 14411 as follows:

### Classification of the ceramic tiles according to their groups of water absorption (E) and their shaping

Shaping	Group I E ≤ 3%	Group IIa 3% < E ≤ 6%	Group IIb 6% < E ≤ 10%	Group III E > 10%
<b>A</b> extruded tiles	Group AIa E ≤ 0.5% (Annex M)	Group AIIa-1a) (Annex B)	Gruppe AIIb-1a) (Annex D)	Group AIII (Annex F)
	Group AIb 0.5% < E ≤ 3% (Annex A)	Group AIIa-2a) (Annex C)	Gruppe AIIb-2a) (Annex E)	
<b>B</b> dry-pressed tiles	Group BIa E ≤ 0.5% (Annex G)	Group BIIa (Annex J)	Group BIIb (Annex K)	Group BIIIb) (Annex L)
	Group BIb 0.5% < E ≤ 3% (Annex H)			
a) The groups AIIa and AIIb are subdivided into two parts (parts 1 and 2) with different product requirements. b) Group BIII essentially applies to glazed tiles. There is a small number of dry-pressed unglazed tiles manufactured with a water absorption of more than 10 % to which this product group does not apply.				

Traditionally the following terms are used:

#### Extruded tiles

(marked with A)

Tiles that are cut off with a certain length from a bar formed from the plastic mass by means of an extruder.

#### Dry-pressed tiles

(marked with B)

Tiles that are formed from a finely ground and subsequently granulated mass by pressing under high pressure.

**Stoneware tiles** are frost-resistant, single extruded vitrified tiles with a firing temperature of appr. 1260 °C.

**KerAion** is the unique extruded ceramic large-size panel from Agrob Buchtal.

**Vitrified dry-pressed tiles** are frost-resistant, single dry-pressed tiles with a firing temperature of up to 1200 °C.

**Porcelain stoneware** stands for especially densely sintered tiles with a water absorption of < 0.5 %.

**Mosaics** are small (porcelain) stoneware tiles stuck onto sheets.

**Earthenware tiles** are non-frost-resistant, single dry-pressed tiles with a firing temperature of up to appr. 1100 °C.

The **water absorption E** in weight-% is determined in accordance with DIN EN ISO 10545-3.

#### Description of dimensions

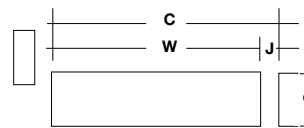

**Coordinating dimension (C) in cm** = Work size (W) + joint (J)  
**Work size (W) in mm** = Dimensions of the visible surfaces and thickness (d)

## Dimensions and Surfaces

### 1 - 5. Dimensions, DIN EN ISO 10545-2

All dimensions are determined in accordance with the standard.

Permissible length and width tolerances corresponding to the product standards						
DIN EN 14411	Group AIa / AIb (25x12.5 cm)		Group AIIa (25x12.5 cm)		Group BIIa / BIIb (30x30 cm)	Group BIII (10x10 cm)
	„Nature“	„Precision“	„Nature“	„Precision“		
Deviation from the work size	± 2%, max. 4 mm	± 1%, max. 2 mm	± 2%, max. 4 mm	± 1.25%, max. 2 mm	± 0.6%, max. 2 mm	± 0.2%, max. 2 mm
Deviation from the average side length	± 1.5%	± 1.0%	± 1.5%	± 1.0%	± 0.5%	± 0.5%

All references to as well as quotations from product and test standards are to be considered as information which is not binding. The latest versions apply.

The work sizes of our **special pieces** are given according to visual sides.

### 6. Surface Quality, DIN EN ISO 10545-2

The surfaces of 1 m<sup>2</sup> or 30 pieces are tested at 300 lux for visible defects at a distance of 1 m.

### 7. Color Deviations, DIN EN ISO 10545-16

Glazed mono-colored products with values of Δ E<sub>cmc</sub> < 0.75 are considered as identical in color; the value of 1.0 applies to unglazed mono-colored products.

#### 7.1. Color Shade Grading

The color shade code is stamped on the box. Only identical color shades will result in a uniform surface look. In the case of rustic split tiles greater color deviations are normal. During laying, tiles from different boxes should be mixed.

### 8. Size Grading

The production sizes vary for technical reasons. The production size is coded and stamped on the box. Only boxes with the same coding should be laid together. According to VOB, the differences are evened out in the joints.

# Physical Properties

## 1. Water Absorption, DIN EN ISO 10545-3

The **water absorption (E)** gives the weight increase as compared to the dry weight of samples saturated with water under vacuum.

### 1.1 Apparent Density, DIN EN ISO 10545-3

It gives the ratio between mass and external volume.

## 2. Modulus of Rupture, DIN EN ISO 10545-4

The breaking strength **F** is determined on samples by means of the three-point load in N. From this, the modulus of rupture and the breaking load are calculated according to the following formula.

### Modulus of Rupture

$$R = \frac{3 \cdot F \cdot L}{2 \cdot b \cdot h^2}$$

- F** = breaking strength in N
- L** = bearing span in mm
- b** = width in mm
- h** = thickness in mm
- R** = modulus of rupture

### Breaking Load

$$S = \frac{F \cdot L}{b}$$

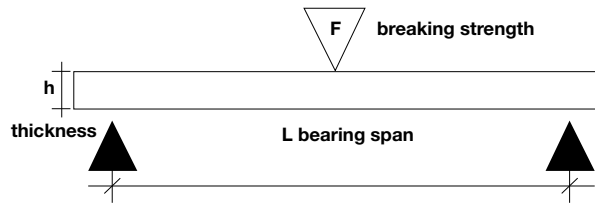

Possible Applications	Stress Group
Breaking strength under 1,500 N Housing construction and floor coverings subject to comparable mechanical stress, e.g. hotel bathrooms, rooms in the health service sector	1
Breaking strength 1,500 – 3,000 N Administration, trade and industry (practicable with vehicles with pneumatic tyres), e.g. canteen kitchens, canteens, traffic zones, car exhibition and maintenance areas, sales rooms, always without industrial truck traffic Floor pressures up to 2 N/mm <sup>2</sup>	2
Breaking strength 3,000 – 5,000 N Trade and industry (industrial truck traffic with superelastic, solid rubber and vulkollan tyres), e.g. in food retailing and wholesaling, non-food retailing and wholesaling, shopping malls Floor pressures 2 to 6 N/mm <sup>2</sup>	3
Breaking strength 5,000 – 8,000 N Trade and industry; areas of application as in group 3, but practicable with polyamide rollers Floor pressures 6 to 20 N/mm <sup>2</sup>	4
Breaking strength above 8,000 N Trade and industry; heavy-duty areas with industrial truck traffic with polyamide rollers; runners of metal parts, such as e.g. in factory buildings, assembly halls and storerooms, repair workshops for machines and heavy equipment Floor pressures > 20 N/mm <sup>2</sup>	5

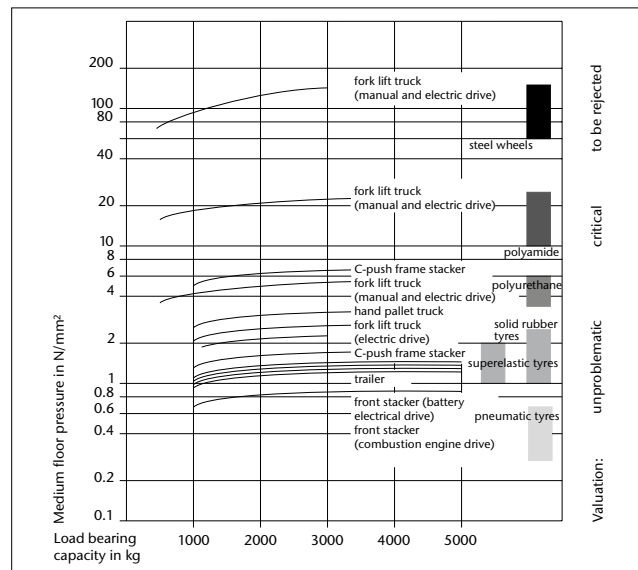

### Floor pressures in N/mm<sup>2</sup> of industrial truck wheels according to a FMPA test in Stuttgart

The table illustrates the floor loads and indicates the effect of the different wheel types: steel wheels should be rejected and polyamide (Nylon and Perlon) is not advisable. Softer tyres ( $\leq 75$  Shore-A-Hardness) as well as larger wheel diameters and wider supporting surfaces are especially advantageous.

#### Important note:

The "application possibilities" are of course only recommendations, as the method and quality of laying are decisive factors. Our recommendations are based on conventional, professional laying. With increasing mechanical load as well as harder tyres a thicker tile is required.

All references to as well as quotations from product and test standards are to be considered as information which is not binding. The latest versions apply.

**Mechanical Strength**

Deutsche Steinzeug offers tiles in thicknesses from 5 up to 20 mm for extreme loads in industrial and commercial areas. The breaking load values of our products partly are by far better than the values required by DIN EN 14411 (the relevant test certificates will be made available on request).

The calculated breaking load indicates the suitability for floors subject to mechanical loads. The stress itself is caused by bending rather than by pressure. The “extra strong” tiles from our programme with their high pressure, breaking and bending strength values are the ideal covering for floors subject to heavy loads. They withstand the wheels of industrial trucks, fork lift trucks and platform lift-trucks with their high floor pressure. They are especially suitable as floor coverings for industrial logistics, hyper- and supermarkets.

**3. Compressive Strength**

The compressive strength of tiles is not standardized. In the case of vitrified dry-pressed tiles it reaches values of up to 150 N/mm<sup>2</sup>. The following conversion table shows the importance of a perfect and professional embedding of the tiles on site. The relatively low values for cement and thin-bed mortar can only be compensated by special and professional laying (mortar composition, water/cement value and manual or mechanical compression).

**4. Resistance to Shock, DIN EN ISO 10545-5**

Rebound measurement with 5 samples.

**5. Resistance to Deep Abrasion, DIN EN ISO 10545-6**

With regard to the deep abrasion on unglazed tiles, the abrasion is determined by means of fusion corundum and a rubbing plate. The lower the value, the higher the wear resistance of the material.

**6. Glaze Abrasion, DIN EN ISO 10545-7**

The **abrasion class** of glazed tiles is established in the wet test. Artificial abrasion is produced with the help of aluminium oxide grains, steel balls and the addition of water in an eccentrically revolving system. The number of revolutions at which a visible change of the test surface occurs results in the following classification:

Resistance to Surface Abrasion	
Class	Revolutions
0	100
1	150
2	600
3	750/1500
4	2100/6000/12000
5	>12000*

\* Must pass the stain test according to DIN EN ISO 10545-14.

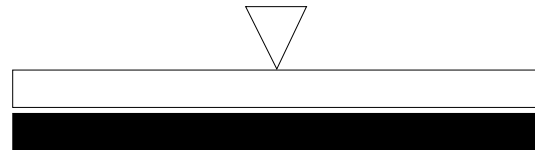

Vitrified material has a compressive strength approx. 10 - 20 times higher than cement mortar, cast plaster floors and reinforced concrete.

**Conversion table for different materials**

Types of material	N/mm <sup>2</sup>	N/cm <sup>2</sup>	kN/cm <sup>2</sup>
Vitrified dry-pressed tiles	100 – 150	10.000 – 15.000	10 – 15
Extruded split tiles	180 – 250	18.000 – 25.000	18 – 25
Cement mortar Gr. III	10	1.000	1
High-grade cement mortar	20	2.000	2
Thin-bed mortar 15 – 30	1.500 – 3.000	1.5 – 3	
Epoxy resins 60 – 75	6.000 – 7.500	6 – 7.5	
Cement screed CT, C12 (ZE 12)	12	1.200	1.2
CT, C20 (ZE 20)	20	2.000	2
CT, C30 (ZE 30)	30	3.000	3
Mechanically resistant floor 65	65	6.500	6.5
Reinforced concrete C 20/25 (B 25)	25	2.500	2.5
C 30/37 (B 35)	35	3.500	3.5

#### Class 0

The use of glazed tiles of this class for floor coverings is not recommended.

#### Class 1

Floor coverings in areas mainly walked on in soft footwear or barefoot and not exposed to abrasive dirt (e.g. bathrooms and bedrooms without direct access from outside).

#### Class 2

Floor coverings in areas occasionally walked on with soft or normal footwear and exposed to only little abrasive dirt (e.g. rooms in living areas of houses, except kitchens, entrances and similar heavily frequented rooms). This does not apply to special footwear such as e.g. hobnailed boots.

#### Class 3

Floor coverings in areas frequently walked on with normal shoes and exposed to little abrasive dirt (e.g. kitchen-cum-living-rooms, halls, corridors, balconies, loggias and terraces). This does not apply to special footwear such as e.g. hobnailed boots.

#### Class 4

Floor coverings walked on regularly and exposed to little abrasive dirt, so that they are subject to greater stress as in the case of class 3 (e.g. commercial kitchens, hotels, exhibition and sales rooms).

#### Class 5

Floor coverings subject to heavy pedestrian traffic over long periods of time and exposed to little abrasive dirt, so that they are subject to the most extreme stress under which glazed tiles can be applicable (e.g. public areas such as shopping centres, entrance halls of airports, hotel foyers, public foot-paths and industrial applications).

Every floor covering is subject to wear. This depends on the area of application and the frequency of use, the kind and degree of dirt as well as the hardness and resistance to wear of the covering material. While unglazed vitrified floor tiles can be used practically anywhere, glazed floor tiles have to be categorized according to stress groups. Scrapers, mats and the like help to remove dirt and abrasives and to protect glazed floor coverings. Something of this kind has to be provided especially in rooms with direct access from outside or from the garden.

#### Extreme Stress

For such areas we recommend the use of integrally colored, unglazed tiles, which are available in a wide range of colors and sizes. Examples: floors subject to high traffic loads, e.g. in supermarkets, hotels, schools, administrative buildings, railway stations, hospitals, passageways, etc., taking into account the mechanical load.

#### 7. Coefficient of Expansion, DIN EN ISO 10545-8

The coefficient of expansion is ascertained between room temperature and 100°C ermittelt. The measured values are at around  $6.0 \times 10^{-6} \text{ m/(m}\times\text{K)}$  in the case of vitrified materials and at around  $8.0 \times 10^{-6} \text{ m/(m}\times\text{K)}$  in the case of porcelain stoneware. At 8 m length and 50° temperature difference the result is a change in length of approx. 2.4 mm in the case of vitrified materials (in the case of screed/concrete 4.6 mm and steel 5.6 mm).

#### 8. Thermal Shock Resistance, DIN EN ISO 10545-9

The thermal shock resistance is tested between 15° and 145°C.

#### 9. Moisture Expansion, DIN EN ISO 10545-10

The moisture expansion is determined between tempered and water-saturated samples.

#### 10. Resistance to Glaze Cracking, DIN EN ISO 10545-11

This test takes place in the autoclave at 500 KPa with subsequent color control.

Glazes with hair cracks/crazes are marked as such and require the wetting of the covering prior to pointing to avoid deposits of fine particles of the pointing mortar in the hair cracks. Colored pointing compounds are not suitable in the case of these glazes. The glaze surfaces must not be marked with felt-tip pen and the like.

#### 11. Thermal Conductivity etc.

Thermal conductivity, heat radiation and storage capacity as well as the thermal resistance are not standardized. Vitrified material produces the following approximate values:

Thermal conductivity:	1 W/mK	Heat storage capacity:	0.8 kJ/kgK
Heat radiation:	5.3 W/m <sup>2</sup> K <sup>4</sup>	Thermal resistance:	0.01m <sup>2</sup> K/W

#### 12. Electrical Leakage Resistance

With a volume resistance of  $>10^{10} \text{ Ohm}$  (DIN EN 1081), our ceramics is insulating in dry condition. With the series Eladuct and KerAion ELA 10.6, however, we offer ceramics for floors capable of discharging static electricity. The glaze of ELA 10.6 has a surface resistance of approx.  $10^6 \text{ Ohm}$  according to DIN EN 1081. The discharge of static electricity is effected from the glaze via conductive joints and tile adhesive into copper strips to be connected to earth, which are laid on the base to be tiled. In the case of Eladuct, the complete tile body is capable of discharging static electricity. The volume resistance according to DIN EN 1081 is approx.  $10^9 \text{ Ohm}$ . Here, conductive joints are not required; apart from that, the base has to be carried out as described for ELA 10.6.

#### 13. Steam Diffusion Resistance

According to DIN EN ISO 12572 the steam diffusion resistance is approx.  $\mu 120,000$  in the case of vitrified material/split tiles and  $\mu 100,000$  in the case of earthenware (excluding joints).

**14. Resistance to Frost, DIN EN ISO 10545-12**

The test for frost resistance is carried out on 10 samples or > 0.25 m<sup>2</sup> samples. After water saturation under vacuum the samples are checked for defects after 100 frost-thaw alternations.

The resistance to frost of an outdoor flooring, however, does not only depend on the quality of the ceramic tiles used.

**Professional construction and laying are essential.** For this, please refer to our specifications and the notice of the umbrella organization of the German building and construction industry "Outdoor Tiled and Paved Coverings".

**15. Light and Color Fastness**

Both glazed and unglazed ceramics are light- and color-fast according to DIN 51094.

**16. Luminance**

The lightness value of a tile describes the brightness of the surface as perceived by the human eye. The measuring value  $Y = 100$  corresponds to the brightness of an absolutely white surface, and  $Y = 0$  to that of an absolutely black surface. The lightness value is determined for mono-colored tiles.

**17. Behaviour in Fire**

Ceramic tiles are classified A 1 according to EN ISO 13501-1 and DIN EN 14411. Therefore, they are generally non-combustible and thus fire-resistant. Also in the case of fire they do not release any toxic emissions.

## Chemical Properties

---

**1. Resistance to Chemicals, DIN EN ISO 10545-13****Resistance to Household Chemicals and Bath Water Additives**

- Household chemicals
  - Ammonium chloride solution 100 g/l
- Bath salts
  - Sodium hypochlorite solution 20 mg/l

**Classes**

A/B/C\*

**Resistance to Acids and Alkalis**

- Low concentration (L)
  - a) Hydrochloric acid solution 3% (V/V)
  - b) Citric acid solution 100 g/l
  - c) Potassium hydroxide solution 30 g/l
- High concentration (H)
  - a) Hydrochloric acid solution 18% (V/V)
  - b) Lactic acid solution 5% (V/V)
  - c) Potassium hydroxide solution 100 g/l

**Classes**

LA/LB/LC or HA/HB/HC\*

**Acid Protection and Apparatus Engineering**

The resistance for acid protection engineering DIN EN 993-16 or chemical apparatus engineering DIN 28062 is subject to individual tests.

\* Class A shows the highest resistance to chemicals, which decreases more and more towards C.

**2. Stain Resistance, DIN EN ISO 10545-14****Stain Forming Substances**

- Stain forming substances, leaving traces
  - Green stain forming substances in oil
  - Red stain forming substances in oil
- Chemical stain forming substances
  - Iodine, 13 g/l in alcohol
- Stain forming substances, forming a film
  - Olive oil

**Cleaning (within the framework of the test)**

- Cleaning agent
  - Hot water (+55 °C)
  - Weak cleaning agent
  - Strong cleaning agent
- Solvent
  - Hydrochloric acid solution 3% (V/V)
  - Potassium hydroxide 200 g/l
  - Acetone

**Classes**

Cl.5 / Cl.4 / Cl.3 / Cl.2 / Cl.1\*

**3. Lead and Cadmium Delivery**

The glazed surfaces are exposed to a 4 percent acetic acid solution. Then, the quantity of the delivered lead and cadmium is determined.

\* Class 5 shows the highest stain resistance, which decreases more and more towards 1.

## Surface Coatings and Upgradings

### Hytect

Hytect is a highly effective and durable coating of tiles and panels of Deutsche Steinzeug. The coating baked onto the surface on the base of titanium dioxide uses the principle of the photocatalysis. It offers the user the following advantages:

#### A) Hytect decomposes bacteria and germs

The surface is activated by sunlight or artificial lighting. Activated oxygen forms, which decomposes microorganisms.

#### B) Hytect eliminates disagreeable odours

Disagreeable or even unhealthy odours in the air are also eliminated by Hytect.

#### C) Hytect reduces the cleaning efforts

The hydrophilic surface makes it possible for water to get under the dirt. In this way the quantity of cleaning agents is considerably reduced, which means a contribution to environmental protection and the saving of time for manual works at the same time.

Hytect surfaces are odourless, non-poisonous, meet the requirements for food and are completely harmless for persons suffering from allergies.

Laying and pointing are carried out by the usual techniques. The conventional agents (without hydrofluoric acid and its compounds) are applicable for cleaning. All additives forming a film, leaving fat on the surface or impregnating are excluded, which impair the surface activation by light.

Renowned institutes in Germany and abroad have confirmed us the corresponding effects of Hytect.

### Protecta Surface Upgrading



#### Better Beats Good ...

Unglazed vitrified tiles are hard-wearing and resistant by nature. Thanks to the Protecta surface upgrading, the stain and dirt resistance could be improved considerably: during the firing process, the coating applied **in-plant** is ceramically bonded to the biscuit and closes the existing "micropores" quite natural for unglazed ceramics. In this way, the penetration of substances forming stains is prevented. Thus, an impregnation is no longer required and may possibly even have a negative effect in the case of slip-resistant tiles with Protecta surface upgrading, as the impregnating agent can not penetrate the tile but remains on the surface as lubricating film.

Products with Protecta surface upgrading are marked with this symbol in the corresponding series:



### Hygiene

Glazed tiles and tiles with Protecta surface upgrading of Deutsche Steinzeug ensure the best possible hygiene conditions. Thanks to the closed surface, they offer no possibility for germs to proliferate. Tests of institutes for hygiene confirm the suitability for the covering of drinking water reservoirs. Hyper-sensitive people such as those suffering from allergies make the best experiences with tiles.

### Cleaning

On principle, claddings and coverings must be protected by appropriate measures against heavy soiling which may be caused in particular by subsequent construction works (painting etc.). Our tiles can generally be cleaned with water and a neutral or alkaline cleaning agent.

In the case of hard water, the sporadic use of acid cleaning agents is required. In the case of stains, cleaning depends on the type of stains and has to be carried out with suitable chemicals.

In the case of a higher concentration of the cleaning agent used, subsequent wiping with clear water is required. Rinsing with clear water is absolutely necessary when carrying out a basic cleaning.

Cleaning agents containing maintenance additives are not recommended by us. They usually reduce the slip resistance and cause a negative visual appearance of the floor covering by forming layers!

Important: the use of cleaning machines with pads containing abrasive grain has a polishing effect by which the slip resistance of the tiles is considerably reduced. We therefore expressly disapprove of such methods. Hydrofluoric acid or its compounds attack the ceramics and cause irreversible damage!

You will find detailed cleaning instructions for ceramic tiles on the Internet at [www.agrob-buchtal.de](http://www.agrob-buchtal.de)

- Service
- Architects & Planners / Dealers / Tilers
- Cleaning instruction.

### Impregnation

Unglazed stoneware without Protecta surface upgrading or Hytect coating should be impregnated in order to prevent the penetration of colored liquids, fats and oils and to facilitate cleaning.

The impregnating agent must be applied on the clean and dry floor; excess material must be removed immediately.

# Slip Resistance

## 1. Coefficient of Friction/Slip Resistance

Workshop rules as well as accident prevention regulations require floors to be smooth, slip-resistant and easy to clean. Special protective measures against slipping are necessary where there is a risk as a result of the use of water, oil, slush, grease or waste. This should be taken into consideration when choosing the surface material. This clear requirement is based on investigations carried out by the insurance companies, which proved that slipping is the primary cause of accidents.

### 1.1. Industrial Areas

Competent authority:  
 Deutsche Gesetzliche Unfallversicherung,  
 Mittelstraße 51, 10117 Berlin-Mitte,  
 phone: +49 (0)30 28876-3800,  
 fax: - 3808, www.dguv.de, info@dguv.de  
 Test standards: DIN EN 16165 and DIN 51133  
 Guideline: ASR A 1.5 - Floors  
 Code of practice: DGUV regulation 108-003 "Floors in work rooms and work areas with high risk of slipping" (previous BGR 181)  
 Test procedure: Inclined plane, safety footwear worn, test medium oil. The surface finish can be smooth, fine-rough, rough or profiled.

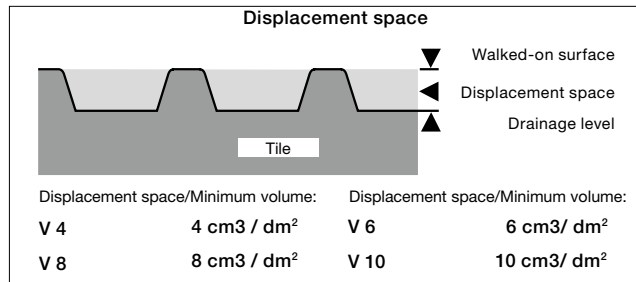

The displacement space (V4-V10) is the open space between the upper walked-on surface and the drainage level of profiled surfaces.

## Valuation Groups

In a detailed table (see next page) the required valuation groups are assigned to work areas where there is a high risk of slipping. Information is available from Deutsche Gesetzliche Unfallversicherung and Agrob Buchtal.

### Test on "inclined plane"

Valuation groups	Angle of inclination	Industrial + commercial areas
R9	> 6° - 10° low static friction	
R10	> 10° - 19° normal static friction	
R11	> 19° - 27° increased static friction	
R12	> 27° - 35° high static friction	
R13	> 35° very high static friction	

The indicated angles of inclination exclusively serve for the assignment of the valuation groups and can not be equated with the angles of inclination of slopes/ramps.

Slip-resistant tiles are marked with the logo "GRIP" in the corresponding series:





**Legal Basis**

Workshop rules as well as accident prevention regulations require floors to be smooth, slip-resistant and easy to clean. The brochure "Technische Regel für Arbeitsstätten" ASR. A 1.5 – Floors (Code of practice for work areas) contains detailed requirements.

**Publisher:**

Bundesanstalt für Arbeitsschutz und Arbeitsmedizin (Ausschuss für Arbeitsstätten) [Federal institute for safety at work and occupational medicine (Committee for work areas)]

**Available at:**

Download at [www.baua.de](http://www.baua.de)

**0 General work rooms and areas\***

0.1	Entrance areas, indoors**)		R9
0.2	Entrance areas, outdoors	R11 (or R10 V4)	
0.3	Stairs, indoors***)		R9
0.4	Outdoor stairs	R11 (or R10 V4)	
0.5	Inclined ramps, indoor****) (from a slope of 3 %; e.g. for wheel chairs, compensation slopes, routes of transport)	One R-group higher than that required for the covering of the access area	V-Value of the covering of the access area, where applicable

**0.6 Sanitary rooms**

0.6.1	Toilets		R9
0.6.2	Changing rooms and washrooms		R10
0.7	Break rooms (e.g. recreation room, company canteens)		R9
0.8	First aid rooms and comparable facilities (see ASR A4.3)		R9

**1 Manufacture of margarine, edible fats and oils**

1.1	Melting of fat		R13 V6
1.2	Cooking oil refinery		R13 V4
1.3	Margarine production and packaging		R12
1.4	Cooking fat production and packing, oil bottling		R12

**2 Milk processing, cheese production**

2.1	Fresh milk processing and butter production		R12
2.2	Cheese production, storage and packaging		R11
2.3	Icecream manufacturing		R12

**3 Chocolate and confectionery production**

3.1	Sugar processing		R12
3.2	Cocoa production		R12
3.3	Production of raw mixtures		R11
3.4	Fabrication of chocolate bars and shells and filled chocolates		R11

**4 Production of bread, cakes and pastries**

	(bakeries, cake shops, production of long-life bakery products)		
4.1	Dough preparation		R11
4.2	Rooms in which predominantly fats or liquid mixtures are processed		R12
4.3	Washing-up rooms		R12 V4

**5 Slaughtering, meat processing**

5.1	Slaughter-house		R13
V10			
5.2	Tripe processing room		R13
V10			
5.3	Meat sectioning		R13 V8
5.4	Sausage kitchen		R13 V8
5.5	Boiled sausage unit		R13 V8
5.6	Raw sausage unit		R13 V6
5.7	Sausage drying room		R12
5.8	Gut store		R12
5.9	Salting and curing rooms, smoking establishments		R12
5.10	Poultry processing		R12 V6
5.11	Cold cuts and packaging unit		R12
5.12	Workshop with sales area		R12 V8 ****)

**6 Fish processing, production of delicatessen**

6.1	Fish processing		R13
V10			
6.2	Production of delicatessen		R13 V6
6.3	Manufacture of mayonnaise		R13 V4

**7 Processing of vegetables**

7.1	Production of sauerkraut		R13 V6
7.2	Vegetable tinning		R13 V6
7.3	Sterilizing rooms		R11
7.4	Rooms in which vegetables are prepared for processing		R12 V4

**8 Wet areas in food and beverage production**

	(if not specifically mentioned)		
8.1	Storage cellars		R10
8.2	Beverage bottling, fruit juice production		R11

**9 Catering establishments**

9.1	Kitchens in the catering trade (restaurant kitchens, hotel kitchens)		R12
9.2	Kitchens catering for homes, schools, day-care facilities for children, sanatoria		R11
9.3	Kitchens catering for hospitals, clinics		R12
9.4	Large kitchens catering for industrial and university canteens, and contract catering		R12
9.5	Food preparation kitchens (fast food kitchens, convenience restaurants and snack bars)		R12
9.6	Kitchens for heating up frozen meals		R10
9.7	Coffee and tea kitchens, hotel garni kitchens and ward kitchens		R10
9.8	Washing-up rooms		
9.8.1	Washing-up rooms for 9.1, 9.4, 9.5		R12 V4
9.8.2	Washing-up rooms for 9.2		R11
9.8.3	Washing-up rooms for 9.3		R12
9.9	Dining rooms, guest rooms, canteens including serving counters		R9
9.10	Counter area, bar area		R10

**10 Cold stores, deep freeze stores**

10.1	for unpacked goods		R12
10.2	for packed goods		R11

**11 Sales outlets, shops**

11.1	Reception of goods, meat		
11.1.1	for unpacked goods		R11
11.1.2	for packed goods		R10
11.2	Reception of goods, fish		R11
11.3	Serving counters for meat and sausage		
11.3.1	for unpacked goods (e.g. loose in transport boxes)		R11
11.3.2	for packed goods		R10
11.4	Serving counters for bread, cakes and pastries, unpacked goods		R10
11.5	Serving counters for dairy products and delicatessen, unpacked goods		R10
11.6	Serving counters for fish		
11.6.1	for unpacked goods		R12
11.6.2	for packed goods		R11
11.7	Serving counters, except for nos. 11.3 to 11.6		R9
11.8	Meat preparation rooms		
11.8.1	for meat preparation, except for no. 5		R12 V8
11.8.2	for meat processing, except for no. 5		R11
11.9	Florists shops		R11
11.10	Sales areas with ovens		
11.10.1	for the production of bread, cakes and pastries		R11
11.10.2	for the warming up of prefabricated bread, cakes and pastries		R10
11.11	Sales areas with chip pans or grills		R12
11.12	Shops, customer rooms		R9
11.13	Preparation areas for food for self-service shops (except for meat, fish and sausage)		R10
11.14	Cash register areas, packing areas		R9
11.15	Outdoor sales areas		R11 (or R10 V4)

**12 Health service rooms**

12.1	Disinfection rooms (wet)		R11
12.2	Pre-cleaning areas of sterilization		R10
12.3	Faeces disposal rooms, discharge rooms, unclean nursing work rooms		R10
12.4	Pathological facilities		R10
12.5	Rooms for medical baths, hydrotherapy, fango preparation		R11
12.6	Washrooms of operating theatres, plastering rooms		R10
12.7	Sanitary rooms, ward bathrooms		R10
12.8	Rooms for medical diagnosis and therapy, massage rooms		R9
12.9	Operating theatres		R9
12.10	Wards with hospital rooms and corridors		R9
12.11	Medical practices, day clinics		R9
12.12	Pharmacies		R9
12.13	Laboratories		R9
12.14	Hairdressing salons		R9

**13 Laundry**

13.1	Rooms with continuous-flow washing machines or with spin-drier		R9
13.2	Rooms with washing machines at which the clothes are taken out dripping wet		R11
13.3	Ironing rooms		R9

**14 Fodder concentrate production**

14.1	Dried fodder production		R11
14.2	Fodder concentrate production using fat and water		R11 V4

<b>15 Leather production, textiles</b>			<b>29 Financial institutions</b>	
15.1 Wet areas in tanneries	R13		29.1 Counter areas	R9
15.2 Rooms with fleshing machines	R13 V10			
15.3 Areas where leather scraps accumulate	R13 V10		<b>30 Plant traffic routes in outdoor areas</b>	
15.4 Rooms for making leather impermeable by means of grease	R12		30.1 Footpaths	R11 (or R10 V4)
15.5 Dye mills for textiles	R11		30.2 Loading platforms	
			30.2.1 covered	R11 (or R10 V4)
<b>16 Paint shops</b>			30.2.2 uncovered	R12 (or R11 V4)
16.1 Wet grinding areas	R12 V10		30.3 Sloping ramps (from a slope of 3 %; e.g. for wheel-chairs, loading platforms)	R12 (or R11 V4)
16.2 Powder coating	R11		30.4 Tank-up areas	
16.3 Painting	R10		30.4.1 covered	R11
			30.4.2 uncovered	R12
<b>17 Ceramics industry</b>			<b>31 Parking areas</b>	
17.1 Wet grinding mills (processing of ceramic raw materials)	R11		31.1 Garages, car-parks not exposed to weather influences****)	R10
17.2 Mixers; handling of materials like tar, pitch, graphite and synthetic resins	R11 V6		31.2 Garages, car-parks exposed to weather influences	R11 (or R10 V4)
17.3 Presses (shaping); handling of materials like tar, pitch, graphite and synthetic resins	R11 V6		31.3 Open-air parking areas	R11 (or R10 V4)
17.4 Moulding, pressure die casting areas	R12			
17.5 Glazing areas	R12		<b>32 Swimming pools</b>	
<b>18 Glass and stone processing</b>			32.1 Individual and common dressing rooms	R10
18.1 Stone cutting, stone grinding	R11		32.2 Sauna and relaxation areas	R10
18.2 Glass shaping of hollow glass ware, container ware	R11		32.3 Showers	R10
18.3 Grinding areas for hollow glass ware, flat glass	R11		NOT recommended by Agrob Buchtal! Please use R11 (in combination with valuation group B)!	
18.4 Insulating glass manufacture; handling of drying agents	R11 V6		32.4 Pool surrounds	R10
18.5 Packaging, shipping of flat glass; handling of anti-adhesive agents	R11 V6		NOT recommended by Agrob Buchtal! Please use R11 (in combination with valuation group B)!	
18.6 Etching and acid polishing facilities for glass	R11			
<b>19 Cast concrete factories</b>				
19.1 Concrete washing areas	R11		*) For floors in wet areas walked on barefoot, see DGUV information "Floor coverings in wet barefoot areas" (DGUV information 207-006).	
<b>20 Storage areas</b>			***) Entrance areas according to number 0.1 are all areas with direct access from outside and in which moisture from outside can be brought (also see section 6 para. 3, utilization of products absorbing dirt and moisture). For adjoining areas or other rooms with large surfaces, section 4 para. 10 has to be observed.	
20.1 Storage areas for oils and fats	R12 V6			
20.2 Storage areas for packed food	R10			
20.3 Outdoor storage areas	R11 (or R10 V4)			
<b>21 Chemical and thermal treatment of iron and metal</b>			****) Stairs and ramps according to numbers 0.3 and 0.5 are those possibly exposed to moisture brought in from outside. For adjoining areas, section 4 para. 10 has to be observed.	
21.1 Pickling plants	R12			
21.2 Hardening shops	R12			
21.3 Laboratory rooms	R11			
<b>22 Metal processing, metal workshops</b>			*****) If the same floor covering was laid in all areas, the displacement space can be lowered down to V4 after a risk assessment (taking into consideration the cleaning method, the working processes and the quantity of slippery substances on the floor).	
22.1 Galvanizing shops	R12			
22.2 Grey cast iron processing	R11 V4			
22.3 Mechanical processing areas (turnery, milling shop), punching room, pressroom, drawing shop (pipes, wires) and areas exposed to increased stress by oil and lubricants	R11 V4		*****) The pedestrian areas which are not subject to a risk of slipping because of weather influences such as driving rain or moisture brought in.	
22.4 Parts cleaning areas, exhaust steam areas	R11 V4			
22.5 Partial cleaning areas, Damping areas	R12			
<b>23 Vehicle repair workshops</b>			Floors in rooms must not present any irregularities, cavities or dangerous slopes; stumbling must be impossible on these floors. They must be secured against shifting or tilting (e.g. in the case of covers), load-bearing and slip-resistant.	
23.1 Repair and servicing bays	R11			
23.2 Working and inspection pits	R12 V4			
23.3 Car washing halls, washing areas	R11 V4			
<b>24 Aircraft repair workshops</b>			Floors are to be designed without inclination. Exception: functional inclinations outside of permanently installed workplaces, e.g. for the drainage of liquids or for bridging differences in height, e.g. with walkable sloping ramps.	
24.1 Aircraft hangars	R11			
24.2 Repair hangars	R12			
24.3 Washing halls	R11 V4			
<b>25 Sewage treatment plants</b>			In areas which must be continuously frequented in the scope of their normal utilization, the slip resistances of the different floor surfaces must not differ from each other to such an extent that there may be a risk of stumbling and slipping. This may be the case if adjoining floor surfaces differ with regard to slip resistance:	
25.1 Pump rooms	R12		1. by more than one R-group in the case of two adjoining areas.	
25.2 Rooms for sludge draining facilities	R12		2. by more than two R-groups if the transition to a different slip resistance is clearly visible or is to be expected (e.g. in the case of door passages).	
25.3 Rooms for screening equipment	R12		If there is a risk of stumbling or slipping due to different slip resistances, appropriate measures have to be taken, such as transition zones which are at least 1.5 m long in the direction of walking.	
25.4 Stands of workplaces, scaffolds and maintenance platforms	R12		Note: It is recommended to design the slip resistance of a floor within a working area as uniformly as possible, e.g. by making sure that other surface qualities within the floor covering, such as covers, markings or films glued on the floor, do not differ from each other by more than one R-group.	
<b>26 Fire brigade buildings</b>			Entrances of buildings have to be designed in such a way that dirt and moisture brought in do not cause a risk of slipping. A sufficiently large roofing above entrances of buildings is an appropriate measure for this. Inside the building, this can be achieved by providing clean-off zones in the form of mats absorbing the dirt and the moisture, which are specially designed for the expected pedestrian traffic with regard to their length, width and the material used and are at least 1.5 m long in the direction of walking over the whole width of the passage. Clean-off zones must be secured against shifting and must not cause a risk of slipping, e.g. by being flush with the directly adjoining floor covering. Depending on the degree of soiling, clean-off zones must be cleaned or replaced in such a way that their functionality is maintained.	
26.1 Vehicle parking places	R12			
26.2 Rooms for hose maintenance equipment	R12			
<b>27 Functional rooms in the respiratory protection training facility</b>				
27.1 Preparation room	R10			
27.2 Fitness room	R10			
27.3 Training room	R11			
27.4 Sluice	R10			
27.5 Target room	R11			
27.6 Acclimatization room	R11			
27.7 Control room	R9			
<b>28 Schools and day-care facilities for children</b>				
28.1 Entrance areas, corridors, assembly halls	R9			
28.2 Class rooms, group rooms	R9			
28.3 Stairs	R9			
28.4 Toilets, washrooms	R10			
28.5 Instructional kitchens in schools (see no. 9.2, 9.6 or 9.7)	R10			
28.6 Kitchens in day-care facilities for children (also see no. 9)	R10			
28.7 Machine rooms for wood processing	R10			
28.8 Special rooms for handicrafts	R10			
28.9 Schoolyards	R11 (or R10 V4)			

No responsibility is taken for the correctness of the information.  
Validity at the time of printing, subject to changes in the meantime.

Depending on the operational exposure to slippery substances to be expected, floors in working rooms and areas must be provided with a discharge facility, if required.  
 The surfaces adjoining discharge openings as well as drain channels should have a slope of at least 2 per cent in order to facilitate the draining of fluid liquids. These areas should preferably be located outside of traffic routes. The discharge of liquids via traffic routes should be avoided, if possible.

Floor surfaces which normally are wet and have to be walked on barefoot, e.g. in swimming pools as well as sanitary rooms such as washing and changing rooms, must be suitable for ensuring safe walking.

**1.2. Barefoot areas**

Competent authority:

Deutsche Gesetzliche Unfallversicherung, Mittelstraße 51, 10117 Berlin-Mitte, tel.: +49 (0)30 28876-3800, fax: - 3808, www.dguv.de, info@dguv.de, www.unfallkassen.de.

Floors in wet barefoot areas, e. g. swimming pools, hospitals as well as dressing rooms, washrooms and showers in sports and work facilities.

Test standard: DIN EN 16165.

Code of practice: DGUV information 207-006 "Floor coverings in wet barefoot areas" (previous GUV-I 8527).

Testing method: Inclined plane, walked on barefoot, wetting agent solution as test medium.

The surfaces are smooth, micro-rough or slightly profiled.

"Nonslip" glazes with their micro-rough surfaces have proved to be excellent in practice.

The various areas are assigned to the valuation groups. Information can be obtained from Deutsche Gesetzliche Unfallversicherung and Agrob Buchtal.

**Valuation group C**

- Ladders and stairs leading into the water
- Stairs up to diving facilities and water slides
- Surfaces of diving platforms and diving boards over the length reserved for the diver (the slip-resistant surface of the diving platforms and diving boards must cover the front edge where the hands and the toes of the divers grip)
- Walk-through pools
- Inclined pool edge designs
- Kneipp basins, water-treading basins
- Ramps in the pool surround area with an inclination > 6 %
- Starting blocks

Walkable seating areas such as e.g. stands and pedestals near the pool into which moisture can be brought must be treated like floor coverings. If barefoot areas are regularly also walked on with footwear, the requirements according to ASR A1.5/1,2 must be observed in addition.



**Valuation group A**

- Barefoot passages and sanitary areas (nearly dry)
- Individual and common dressing rooms
- Pool floors in non-swimmer areas if the water depth is more than 80 cm in the entire area
- Sauna and relaxation areas (nearly dry)

**Valuation group B**

- Barefoot passages and sanitary areas, if not classified in group A
- Showers
- Steam baths
- Area of disinfecting spray facilities
- Pool surrounds
- Pool floors in non-swimmer areas if the water depth is less than 80 cm in certain areas
- Non-swimmer sections of wave-action pools
- Movable floors
- Paddling pools
- Ladders and stairs outside the pool area , if not classified in group C
- Accessible surfaces of diving platforms and diving boards, if not classified in group C
- Sauna and relaxation areas, if not classified in group A

**Test on "inclined plane"**

Valuation groups	Angle of inclination	Barefoot area
A	≥12°	
B	≥18°	
C	≥24°	

The indicated angles of inclination exclusively serve for the assignment of the valuation groups and can not be equated with the angles of inclination of slopes/ramps.

All references to as well as quotations from product and test standards are to be considered as information which is not binding. The latest versions apply.

### 1.3. Measurement of sliding friction

Competent authority:

Deutsche Gesetzliche Unfallversicherung, Mittelstraße 51, 10117 Berlin-Mitte, tel.: +49 (0)30 28876-3800, fax: - 3808, www.dguv.de, info@dguv.de, www.unfallkassen.de.

Test standard: DIN 51131

Code of practice: DGUV information 208-041 "Assessment of the risk of slipping under operating conditions" (previous GUV-I 8687).

This test is not a type examination and thus is neither suitable for the choice of floor coverings at the planning stage nor for classification in a slip-resistance valuation group. The method can be applied, e.g. for assessing the success of cleaning measures or in the event of planned changes of utilisation.

For the choice of a floor covering, DGUV information 108-003 (previous BGR 181) and DGUV information 207-006 (previous GUV-I 8527) respectively must be applied exclusively!

### 1.4. Private areas

With regard to slip resistance, ceramic floor coverings in private areas are not subject to standard regulations. Independent of that, however, we recommend that you choose slip-resistant tiles according to your personal safety requirements.

## Color Shade Variation

"Color shade variation" refers to the variations in color between the tiles of a certain color, i.e. the degree of shading. Our products are classified into 4 shading coefficients.

**V0** = No variation / no play of colors

**V1** = Low variation / low play of colors

**V2** = Medium variation / medium play of colors

**V3** = High variation / high play of colors

**V4** = Strong variation / strong play of colors

## Mosaics glued thermoplastically on back: Permanently safe also in wet areas

The thermoplastic glueing of mosaics of the brands Agrob Buchtal and Jasba is also perfectly suitable for permanently wet and underwater areas. Analyses of independent institutes have proved that no microbiological infestation at the glass fibre net occurs under normal hygienic conditions. With the values  $>0.5\text{N/mm}^2$ , the bonding behaviour after dry and wet storage is better than the values required according to DIN EN 12004. Thus, the thermoplastic glueing on back can be recommended not only for dry areas but also for underwater areas (swimming pools and whirlpools) as well as for per-

manently wet areas such as showers and pool surrounds. In addition, the glueing on back facilitates laying and leads to considerable time saving compared to the film on the face side required so far. The glass fibre net on the back largely prevents the penetration of tile adhesive in the joints. The time-consuming removal of the film and possible residues on the tile surface is no longer necessary, and the cladding of columns and curvatures is significantly simplified.

## List of Addresses

---

### Bundesanstalt für Arbeitsschutz und Arbeitsmedizin (BAuA)

(Federal institute for safety at work and occupational medicine)  
 Friedrich-Henkel-Weg 1-25, 44149 Dortmund  
 Telephone: +49-231-9071-0, Fax: -2454,  
 www.baua.de, poststelle@baua.bund.de

### DGUV Rules and Regulations (BG/GUV)

Deutsche Gesetzliche Unfallversicherung  
 Mittelstraße 51, 10117 Berlin-Mitte,  
 Telephone: +49-30-28876-3800, Fax: -3808,  
 www.dguv.de, info@dguv.de

### DIN/EN/ISO Standards Sheets

Deutsches Institut für Normung e.V., 10772 Berlin  
 Telephone: +49-30-2601-0, Fax: -60,  
 www.din.de, info@din.de,  
 Available from:  
 Beuth Verlag GmbH, Burggrafenstraße 6,  
 10787 Berlin, Telefon: +49-30-2601-2201-0, Fax: -1260,  
 www.beuth.de, info@beuth.de

### KOK-Directives for Swimming Pool Construction

RK-List of Tested Cleaning Agents  
 DGfB Rules and Regulations  
 Deutsche Gesellschaft für das Badewesen e.V.,  
 45130 Essen  
 Telephone: +49-201-87969-0, Fax: -20,  
 www.baederportal.com, info@baederportal.com  
 Directly available from the publisher

### Bundesverband Keramische Fliesen e. V.

Luisenstraße 44, 10177 Berlin  
 Telephone: 030/27 59 59 74-0, Fax: -99  
 www.fliesenverband.de, info@fliesenverband.de

### ZDB Notices

Professional Association for Tiles and Natural Stone in the  
 Central Association of the German Construction Industry  
 Kronenstr. 55 - 58, 10117 Berlin-Mitte,  
 Telephone: +49-30-20314-0, Fax: -419,  
 www.fachverbandfliesen.de, info@fachverband-fliesen.de  
 Available from:  
 Verlagsgesellschaft Rudolf Müller GmbH & CoKG,  
 Stolberger Straße 84, 50933 Köln  
 Postfach: 410949, 50869 Köln  
 Telephone: +49-221-5497-112, Fax: -6112  
 www.baufachmedien.de, service@rudolf-mueller.de

### Quality Controls

Quality controls are carried out by:

- manufacturers themselves with strict sorting
- controls and special tests by the Deutsche Steinzeug  
laboratories
- individual and batch testing by external material  
testing institutions in Germany and abroad

## Certificates

---

The characteristics and the quality of our products are constantly  
 tested by acknowledged material testing institutions.  
 The corresponding test certificates are available.



\* We will be pleased to make a survey of the certified individual  
 products available to you on request.

## Shower Tub System – Area Pro/Plural non-slip/Plural unglazed/Basis 3

The shower tub system consists of special tiles for realizing a shower tub integrated in the tile covering.

The shower tub system is a registered design. It meets the requirements of DIN 18040 “Barrier-free building” and DIN 18025 “Barrier-free living”.

In Germany, the 10 mm lip means that it is possible to take full advantage of various housing grants.

The 100 mm modular dimension inclusive of a 3 mm wide joint guarantees perfectly hygienic tile coverings with a narrow joint width and accurately sized tiles.

As with all slip-resistant surfaces of Plural non-slip/Plural unglazed, the series Basis 3, the surfaces of both the glazed and the ceramically upgraded unglazed tiles are very easy to clean.

The shower tub system is predestined for wet areas in hospitals, sanatoriums, rehabilitation centres, old people’s and nursing homes, but also for showers in commercial areas, swimming pool, sauna and sports facilities, hotel and private bathrooms.

1. The shower tub is a module with the necessary slope that can be integrated in the joint grid of the tile covering as required.

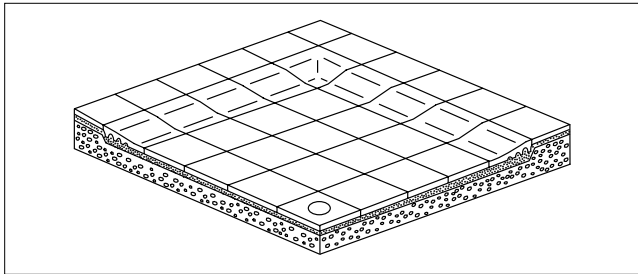

2. In combination with the cove skirting laid horizontally, a rounded transition between floor and wall covering is possible.

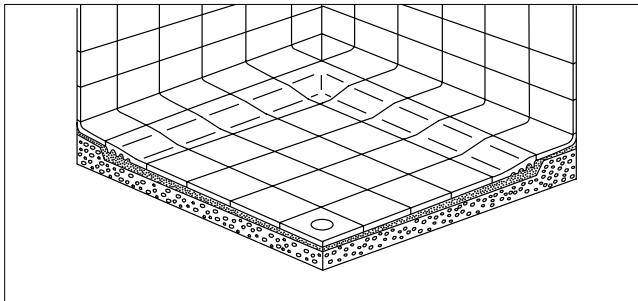

**Area Pro, Plural non-slip,  
Plural unglazed**

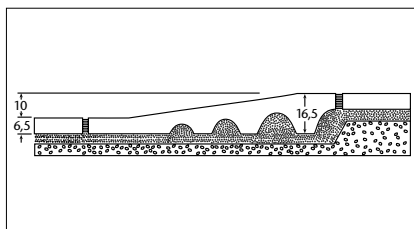
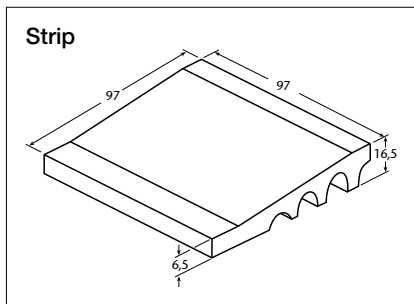
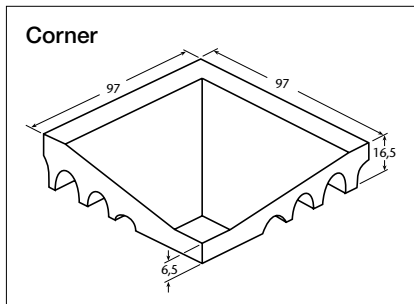

**Basis 3 Softcorn**

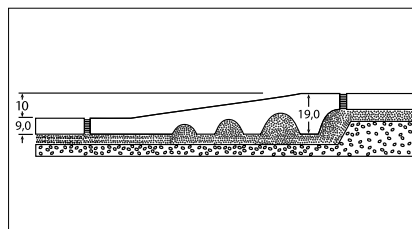
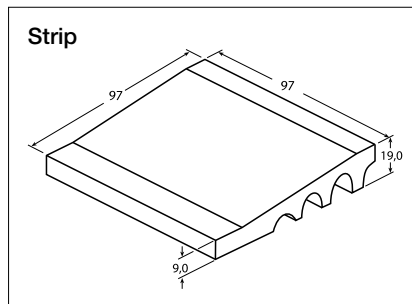
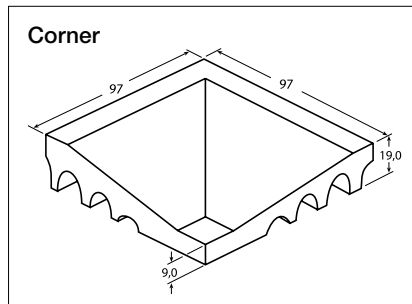

All references to as well as quotations from product and test standards are to be considered as information which is not binding. The latest versions apply.

## The Shower Tub System of the Series Chroma / Chroma unglazed – Quantum

This shower tub system consists of only two components: the strip and the one-piece corner belonging to it.

A peculiarity of the system is the special form of the slope which provides a difference in height of 10 mm. The edge of the shower tub designed in this manner is easy to pass on foot and with a wheel-chair. The relevant requirements (DIN 18040 or 18025) with regard to barrier-free construction taking into account the needs of senior and handicapped persons are effectively supported in this way.

Thanks to the “integrated slope” the time-consuming execution of the edge of the shower tub on site is no longer required, and together with the even lower side facilitating laying the processing of these tiles is absolutely simple:

The shower tub system is perfectly completed by the series Chroma / Chroma unglazed – Quantum.

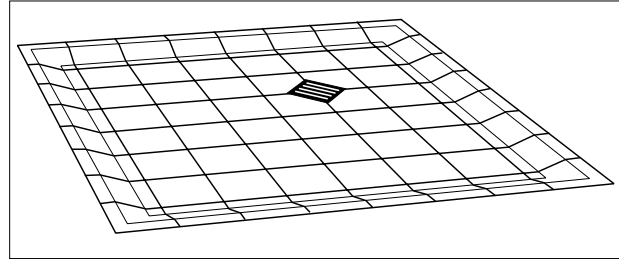

The shower tub system is based on a grid size of 12.5 x 12.5 cm. This permits a very variable dimensioning of the shower tub independent of standard dimensions and a harmonious integration in the shower installation or sanitary block.

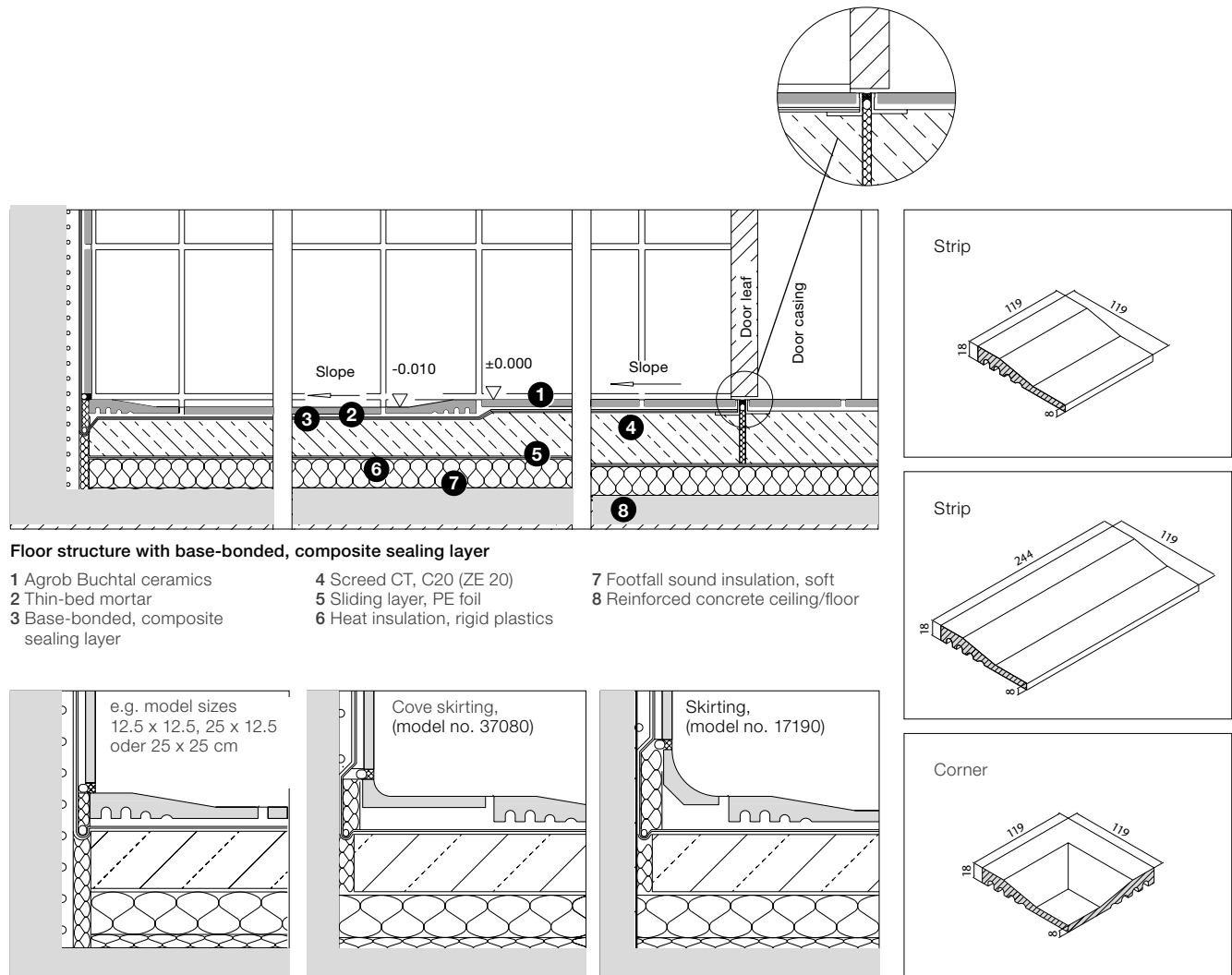

### Wall connection variants

The shower tub systems of Agrob Buchtal are laid on a continuous screed and therefore do not require a high-maintenance movement joint between shower tub and adjoining areas.

All references to as well as quotations from product and test standards are to be considered as information which is not binding. The latest versions apply.

## Cove Skirting

### Cove Skirting 10 x 10 cm

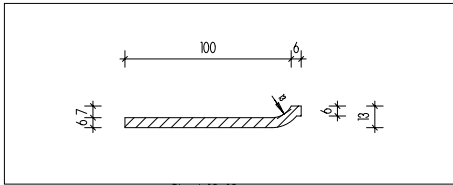

Fitting to:

**Area Pro**, smooth, 10 x 10 cm, unglazed  
**Plural/Plural non-slip**, smooth and slip-resistant, 10 x 10 cm  
**Basis 2**, smooth, 10 x 10 cm, glazed  
**Basis 3**, smooth, 10 x 10 cm, unglazed  
**Plural unglazed**, smooth, 10 x 10 cm

### Cove Skirting 10 x 15, 10 x 20, 10 x 30 and 10 x 60 cm

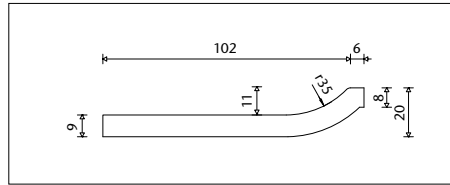

Fitting to:

**Emotion GRIP**, smooth oder Softcorn, 10 x 20, 10 x 30 cm, unglazed  
**Basis 3**, smooth, 10 x 15, 10 x 20 cm, unglazed  
**Basis Pro**, smooth, 10 x 30 cm, unglazed  
**Area Pro**, smooth, 10 x 20, 10 x 30 and 10 x 60 cm, unglazed

### Cove Skirting 10 x 25, 10 x 50 and 10 x 60 cm

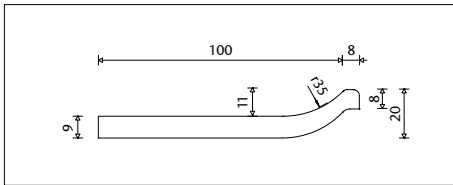

Fitting to:

**Ascona**, strukturiert, 10 x 25, 10 x 50, 10 x 60 cm, glazed  
**Nova**, smooth, 10 x 60 cm, glazed  
**Quarzit**, strukturiert, 10 x 60 cm, glazed

### Cove Skirting 12.5 x 25 cm

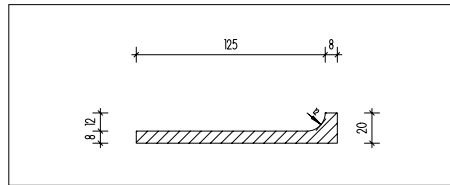

Fitting to:

**Chroma unglazed**, smooth, 12.5 x 25 cm, unglazed

### Cove Skirting 12.5 x 25 cm

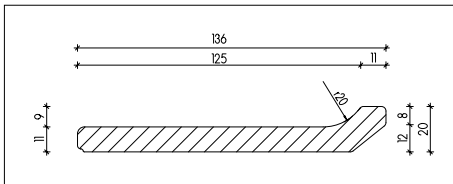

Fitting to:

**Ferrum**, smooth, 12.5 x 25 cm, unglazed

## Internal Corner

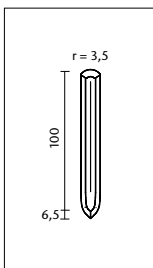

Fitting to  
 cove skirting:

**Plural non-slip**,  
 10 x 10 cm, glazed

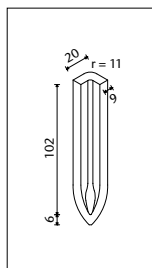

Fitting to  
 cove skirting:

**Area Pro**,  
 10 x 10, 10 x 20, 10 x 30,  
 10 x 60 cm, unglazed

**Emotion GRIP**,  
 10 x 20 und 10 x 30 cm, unglazed

**Basis 3**,  
 10 x 20 cm, unglazed

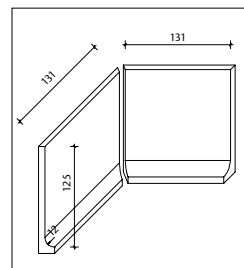

Fitting to  
 cove skirting:

**Chroma unglazed**,  
 12.5 x 25 cm, unglazed



External corner

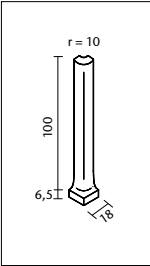

Fitting to cove skirting:  
**Plural non-slip,**  
 10 x 10 cm, glazed

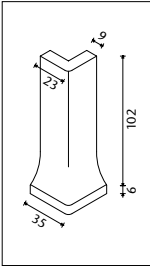

Fitting to cove skirting:  
**Area Pro,**  
 10 x 10, 10 x 20, 10 x 30,  
 10 x 60 cm, unglazed  
**Emotion GRIP,**  
 10 x 20 und 10 x 30 cm,  
 unglazed  
**Basis 3,**  
 10 x 20 cm, unglazed

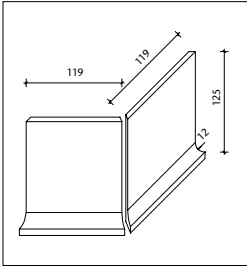

Fitting to cove skirting:  
**Chroma unglazed,**  
 12.5 x 25 cm, unglazed

Cove skirtings, cut/glued 15 x 60 cm and internal corners 15 x 15 cm

Details: Can be manufactured from any tiles/panels. The look and the haptics correspond to those of the adjoining surface, i.e. both the same structure and the same color are guaranteed. Minimum order quantity for the skirtings: 50 pieces; corner: 50 pieces.

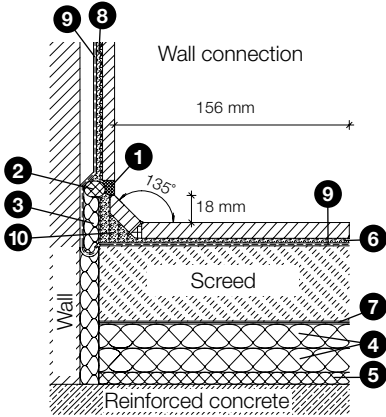
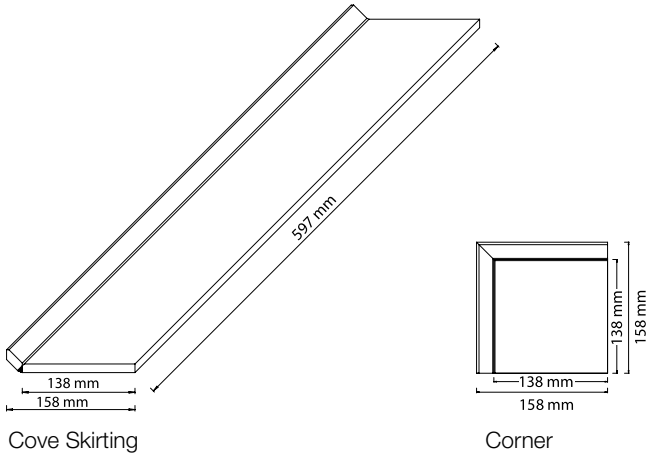

Scale 1:5

- 1 UW Silicone
- 2 Closed-cell PE foam cord or seperating foil
- 3 Water-resistant elastic filling material
- 4 Heat insulation, rigid foam
- 5 Footfall sound insulation, soft
- 6 Mortar / adhesive
- 7 Sliding layer, PE foil
- 8 Thin-bed laying on rendering
- 9 Base-bonded sealing layer
- 10 Solid backfill

### Stair safety borders / stair tiles

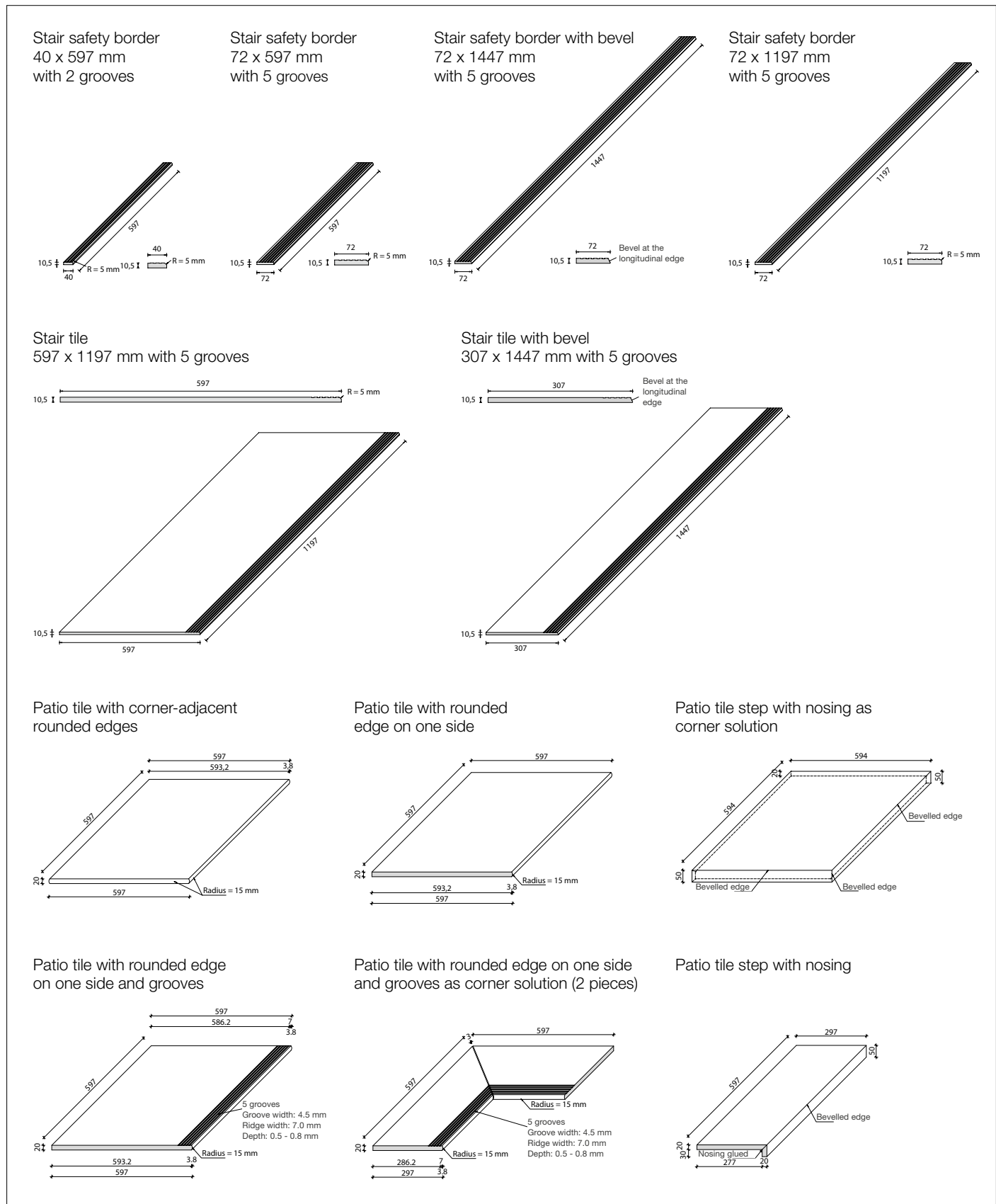

### 1. Construction Products Regulation (CPR)

The CPR distinguishes itself from the previous Construction Products Directive (CPD) above all by the Declaration of Performance, CE marking as well as assessment and verification of the constancy of performance of the product concerned.

Construction products brought into circulation after 1 July 2013 must comply with the CPR. "Bringing into circulation" means that a construction product is made available on the European market for the first time by the manufacturer. We would like to point out that the term of "provision" is delineated from that; it means the passing on of a construction product brought into circulation in the supply chain, e.g. from the specialist tile trade to end consumers.

Essential characteristics of a construction product – here ceramic tiles – are defined in Annex ZA of the harmonised standard DIN EN 14411.

### 2. CE marking

With the CE marking, the manufacturer indicates that it assumes responsibility for the conformity of the construction product with the performance stated in the Declaration of Performance as well as compliance with all relevant European legal regulations.

Furthermore, it is responsible for making sure that the CE marking is applied to the actual construction product, to a label or on the packaging. The CE marking is the sole conformity identification for all essential characteristics of a construction product. Additional marks may only be used for aspects which – in our case – are not regulated by DIN EN 14411.

### 3. Declaration of Performance

As of 1 July 2013, every manufacturer is obliged to establish a Declaration of Performance for each of its construction products. It thereby assumes responsibility for the conformity of the construction product with the declared performance. The Declaration of Performance replaces the former Declaration of Conformity.

The technical documentation of the manufacturer serves as basis for the Declaration of Performance. Among other things, it includes the results of the in-plant production controls such as e.g. initial tests.

The Declaration of Performance has to be provided with an arbitrary reference number by the manufacturer to which the CE marking refers, thus permitting unambiguous identification of the construction product.

The Declaration of Performance can be made available in printed or electronic form (e.g. by e-mail, CD or USB stick).

In addition, the Declarations of Performance for the construction products of Agrob Buchtal GmbH are to be found at [www.agrob-buchtal.de/leistungserklaerung](http://www.agrob-buchtal.de/leistungserklaerung). Alternatively, you can scan this QR code:







**Albania**

Markus Pavelic  
Tel.: +49 94 35 3 91-3463  
Mobile: +49 171 56 74 713  
E-Mail: markus.pavelic@agrob-buchtal.de

**Australia**

Ceramic Solutions (Aust) Pty Ltd.  
Tel.: +61 3 95 45 53 22  
E-mail: mail@ceramicsolutions.com.au  
Internet: www.ceramicsolutions.com.au

**Austria**

Robert Wöflner  
Tel.: +43 664 1342659  
E-Mail: robert.woelfler@agrob-buchtal.de

**Bahrain**

Patric Kakoschky  
Tel.: +49 94 35 3 91-34 47  
Mobile: +49 160 7417906  
E-mail: patric.kakoschky@agrob-buchtal.de

**Baltic States**

Nedas Bobinas  
Tel.: +370 65 624217  
E-mail: buchtal.baltic@gmail.com

**Belgium**

Philip Daelemans  
Mobile: +32 495 30 33 03  
E-mail: philip.daelemans@buchtal.be

**Bosnia-Herzegovina**

Markus Pavelic  
Tel.: +49 94 35 3 91-3463  
Mobile: +49 171 56 74 713  
E-Mail: markus.pavelic@agrob-buchtal.de

**Bulgaria**

Hristo Shterev  
Mobile: +359 886 899 589  
E-mail: hshterev@gmail.com

**Canada**

Eastern Canada  
CERAGRES TILE GROUP INC.  
E-mail: j.racine@ceragres.ca

**Western Canada**

V.P. Tile Imports  
Tel.: +1 604 240 1760  
E-mail: peter@vptile.ca

**China**

Jeffrey Lung - Agrob Buchtal GmbH  
Shanghai Office  
Tel.: +86 021 63 81 09 86  
E-mail: jeffrey.lung@ds-k-asia.com

Jeffrey Lung - Agrob Buchtal GmbH  
Beijing Office  
Tel.: +86 010 58 69 19 01  
E-mail: jeffrey.lung@ds-k-asia.com

**Croatia**

Markus Pavelic  
Tel.: +49 94 35 3 91-3463  
Mobile: +49 171 56 74 713  
E-Mail: markus.pavelic@agrob-buchtal.de

**Cyprus**

E.K.A. Ltd.  
Tel.: +357 2 5 85 44 44  
E-mail: mloizides@ekagroup.com

**Czech Republic**

Ceram Objekt s.r.o.  
www.ceramobjekt.cz  
Tel.: +420 2 71 74 17 414  
E-mail: gciprianova@ceramobjekt.cz

**Denmark**

Torben Christensen  
Tel.: +45 242 05 14 8  
E-mail: buchtal@buchtal.dk

**Egypt**

Patric Kakoschky  
Tel.: +49 94 35/3 91-34 47  
Mobile: +49 160 7417906  
E-mail: patric.kakoschky@agrob-buchtal.de

**Finland**

ABL Finland OY  
Tel.: +358 9 3 50 87 00  
E-mail: abl@abl.fi

**France**

Christophe Rodriguez  
Deutsche Steinzeug France S.A.R.L.  
Mobile: +33 6 40 94 34 32  
E-mail: buchtal@buchtal.fr

**Great Britain**

Rolf Klebl  
Mobile: +49 160 74 28 839  
E-mail: rolf.klebl@agrob-buchtal.de

**Greece**

Emco S.A.  
Tel.: +30 210 6 13 83 10  
E-mail: jbog@emco.gr

**Hungary**

Roland Fekete  
Tel.: +36 96 51 70 17  
E-mail: feketeroland@buchtal.hu

**Iceland**

Birgisson ehf  
Tel.: +354 5160602  
E-mail: egill@birgisson.is  
Internet: www.birgisson.is

**India**

Patric Kakoschky  
Tel.: +49 94 35 3 91-34 47  
Mobile: +49 160 7417906  
E-mail: patric.kakoschky@agrob-buchtal.de

**Italy**

Luigi Maresca  
Tel.: +49 94 35 3 91-34 51  
E-mail: luigi.maresca@agrob-buchtal.de

**Japan**

Rolf Klebl  
Tel.: +49 94 35 3 91-33 26  
Mobile: +49 160 742 88 39  
E-mail: rolf.klebl@agrob-buchtal.de

**Kosovo**

Markus Pavelic  
Tel.: +49 94 35 3 91-3463  
Mobile: +49 171 56 74 713  
E-Mail: markus.pavelic@agrob-buchtal.de

**Kuwait**

Patric Kakoschky  
Tel.: +49 94 35 3 91-34 47  
Mobile: +49 160 7417906  
E-mail: patric.kakoschky@agrob-buchtal.de

**Lebanon**

Patric Kakoschky  
Tel.: +49 94 35 3 91-34 47  
Mobile: +49 160 7417906  
E-mail: patric.kakoschky@agrob-buchtal.de

**Luxembourg**

Philip Daelemans  
Mobile: +32 495 30 33 03  
E-mail: philip.daelemans@buchtal.be

**Macedonia**

Markus Pavelic  
Tel.: +49 94 35 3 91-3463  
Mobile: +49 171 56 74 713  
E-Mail: markus.pavelic@agrob-buchtal.de

**Moldavia**

Sabin Maghiar  
Tel.: +40 743 45 29 58  
E-mail: sabin.maghiar@deutsche-steinzeug.ro

**Montenegro**

Markus Pavelic  
Tel.: +49 94 35 3 91-3463  
Mobile: +49 171 56 74 713  
E-Mail: markus.pavelic@agrob-buchtal.de

**Namibia**

O. Behrens & Co. (PTY) Ltd., Windh.  
Tel.: +264 61 23 83 00  
E-mail: perstling@obeco.com.na

**The Netherlands**

Luuk Bovens  
Mobile: +31 623 838399  
E-mail: luuk.bovens@agrob-buchtal.de

**Norway**

Stein M. Skogstad  
Tel.: +47 66 77 94 98  
Mobile: +47 91 39 52 08  
E-mail: stein@agrob-buchtal.no

**Poland**

Rafal Butkiewicz  
Tel.: +48 6 01 70 67 57  
E-mail: biuro@agrob-buchtal.pl

**Portugal**

Lusomatec  
Tel.: +351 915828266  
E-mail: nuno.conceicao@lusomatec.pt  
Internet: www.lusomatec.pt

**Qatar**

Patric Kakoschky  
Tel.: +49 94 35 3 91-34 47  
Mobile: +49 160 7417906  
E-mail: patric.kakoschky@agrob-buchtal.de

**Romania**

Sabin Maghiar  
Tel.: +40 743 45 29 58  
E-mail: sabin.maghiar@deutsche-steinzeug.ro

**Saudi Arabia**

Patric Kakoschky  
Tel.: +49 94 35 3 91-34 47  
Mobile: +49 160 7417906  
E-mail: patric.kakoschky@agrob-buchtal.de

**Serbia**

Markus Pavelic  
Tel.: +49 94 35 3 91-3463  
Mobile: +49 171 56 74 713  
E-Mail: markus.pavelic@agrob-buchtal.de

**Slovakia**

BUCHTAL SK, s.r.o.  
Tel.: +421 2 44 25 03 69  
E-mail: b.hauswald@agrobuchtal.sk  
Internet: www.agrobuchtal.sk

**Slovenia**

Lokar Zastopstva d.o.o.  
Tel.: +386 15 61 21 63  
E-mail: lokar.zastopstva-ds@siol.net

**South Africa (RSA)**

Patric Kakoschky  
Tel.: +49 94 35 3 91-34 47  
Mobile: +49 160 7417906  
E-mail: patric.kakoschky@agrob-buchtal.de

**Spain**

Joaquín Prat Pérez-Nieves  
Mobile: +34 607 923 470  
E-mail: joaquin.prat@buchtal.es  
Internet: www.buchtal.es

**Sweden**

Stein M. Skogstad  
Tel.: +47 66 77 94 98  
Mobile: +47 91 39 52 08  
E-mail: stein@agrob-buchtal.no

**Switzerland**

Deutsche Steinzeug Schweiz AG  
Tel.: +41 41 6 32 50 60  
E-mail: info@deutsche-steinzeug.ch

**Turkey**

Patric Kakoschky  
Tel.: +49 94 35 3 91-34 47  
Mobile: +49 160 7417906  
E-mail: patric.kakoschky@agrob-buchtal.de

**UAE**

Patric Kakoschky  
Tel.: +49 94 35 3 91-34 47  
Mobile: +49 160 7417906  
E-mail: patric.kakoschky@agrob-buchtal.de

**Ukraine**

Markus Pavelic  
Tel.: +49 94 35 3 91-3463  
Mobile: +49 171 56 74 713  
E-Mail: markus.pavelic@agrob-buchtal.de

---

**Sales management**

**Austria**

Robert Wöflner  
Tel.: +43 664 1342659  
E-mail: robert.woelfler@agrob-buchtal.de

**Belgium, The Netherlands, Luxembourg**

Richard van der Maaten  
Mobile: +31 (0)621 478134  
E-mail: richard.van-der-maaten@agrob-buchtal.de

**Eastern Europe without Bulgaria, Poland and Romania**

Markus Pavelic  
Tel.: +49 94 35 3 91-3463  
Mobile: +49 171 56 74 713  
E-Mail: markus.pavelic@agrob-buchtal.de

**France, Spain, Portugal, Monaco, Andorra**

Christophe Rodriguez  
Mobile: +33 640 94 34 32  
E-mail: christophe.rodriguez@agrob-buchtal.de

**Korea, Taiwan, Hong Kong, Thailand, China, Japan, Singapore, Indonesia, The Philippines, Malaysia, Brunei, Vietnam, Myanmar, Laos, Cambodia**

Jeffrey Lung  
Mobile: +852 51 67 36 66  
E-mail: jeffrey.lung@ds-k-asia.com

**Australia / New Zealand, Bulgaria, Cyprus, Egypt, Greece, India, Iran, Iraq, Libya, Middle East, Namibia, Poland, Romania, Sudan South Africa and Turkey**

Patric Kakoschky  
Tel.: +49 94 35 3 91-34 47  
Mobile: +49 160 741 79 06  
E-mail: patric.kakoschky@agrob-buchtal.de

**Northern Europe, Baltic States, Canada, Great Britain, Ireland**

Rolf Klebl  
Tel.: +49 94 35 3 91-33 26  
Mobile: +49 160 742 88 39  
E-mail: rolf.klebl@agrob-buchtal.de

**Italy**

Luca Bononcini  
Mobile: +39 348 8957344  
E-Mail: luca.bononcini@agrob-buchtal.de

**Switzerland**

Deutsche Steinzeug Schweiz AG  
Renato Borsani  
Tel.: +41 41 632 50 60  
E-mail: renato.borsani@deutsche-steinzeug.ch

**USA**

DSA Deutsche Steinzeug America, Inc.  
Tel.: +1 770 442 55  
Fax: +1 770 442 55  
Udo Reich  
E-mail: udo.reich@agrob-buchtal.com  
E-mail: udo.reich@drytilenorthamerica.com  
E-mail: info@agrob-buchtal.com  
Internet: www.agrob-buchtal.com

**Latin America**

Diego Chavez  
Tel.: +591 76 34 04 22  
E-mail: diego@buchtal.latam.com  
Internet: www.gcclatinoamerica.com

Project: Bildungspark Schweizerischer Plattenverband / Location: Dagmersellen, Switzerland / Architect: Amberg Architekten AG, Sursee, Switzerland  
Series: Craft / Photo: Adriano Faragulo







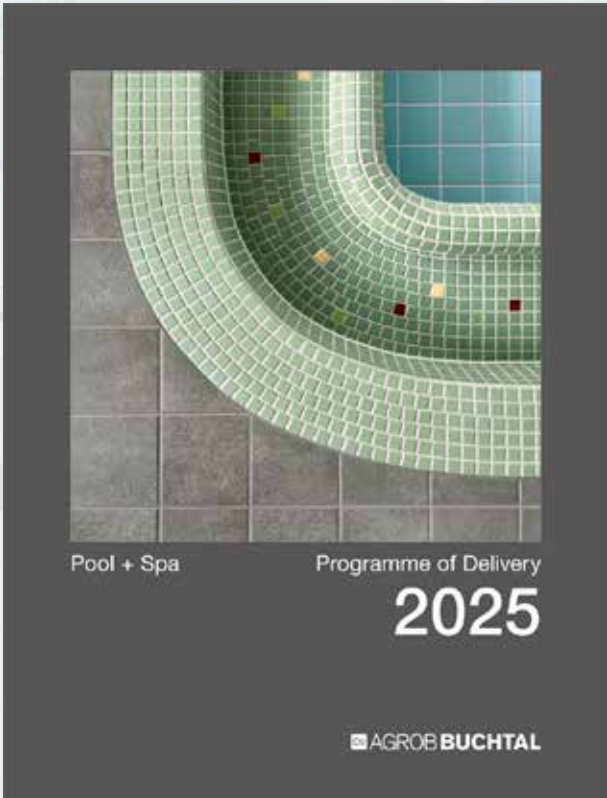
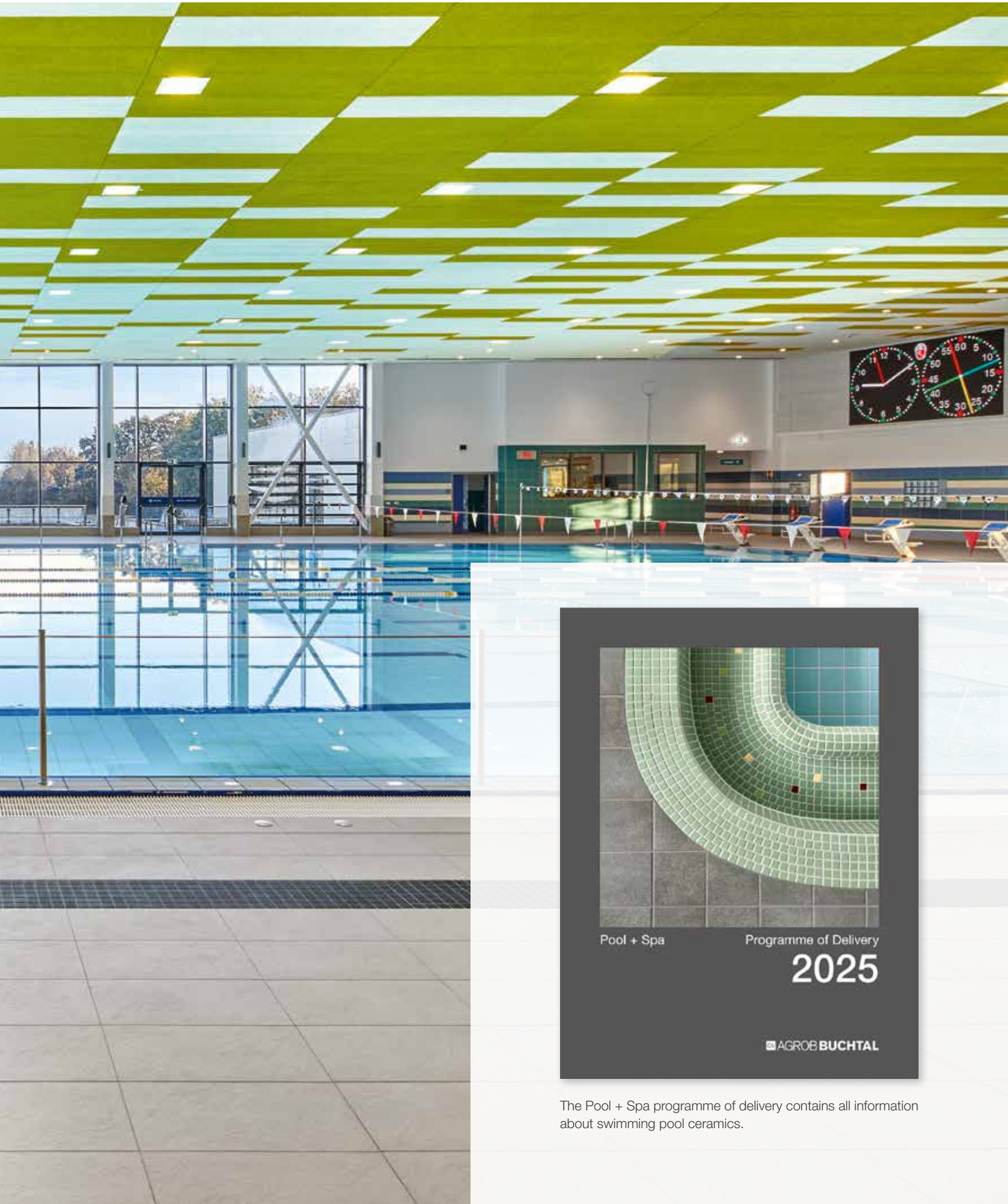

The Pool + Spa programme of delivery contains all information about swimming pool ceramics.

**Easy to find**

Each individual series is always represented as follows:

- Color chart
- Short description
- Product specifications

- 1 **Series name;** sort of material (see page 521) and relevant product standard (see page 523)
- 2 **Schematic arrangement of the models** from left to right: Standard models from small to large: in the case of extruded split tiles, at first rectangular and then square models from small to large, fittings/special pieces

3 **Peculiarities** of the model

4 **Model number** (only in the case of extruded split tiles)

5 **Nominal dimensions** = work size + recommended joint width in centimetres and inches  
**Work size** = only material dimensions without joint

6 **Surface quality**

7 **Logistic product specifications**

8 **Product standard**

9 **Slip-resistance classification:**  
 Barefoot areas/public and industrial areas (see pages 11 and 528 and the following)

10 **Stress groups 1-5;** orientation help for the industrial and commercial sector (see page 524 and the following)

11 **Article number**





12 **Abrasion**  
 In the case of glazed materials according to stress groups 1 - 5; (see page 525)

13 **Designation and/or number of color**

14 **Price group** (pricing unit in brackets)

















15 **Color Shade Variation**  
 ("Color shade variation" refers to the variations in color between the tiles of a certain color, i.e. the degree of shading. Our products are classified into 4 shading coefficients.)

- V0** No variation / no play of colors
- V1** Low variation / low play of colors
- V2** Medium variation / medium play of colors
- V3** High variation / high play of colors
- V4** Strong variation / strong play of colors

402		<b>Plural non-slip 1</b>		
		<b>stoneware</b>		
		<b>2 Mosaic<sup>2/4</sup></b>		
		2,5 x 2,5 cm	5 x 5 cm	10 x 10 cm
				
				
		<b>3</b> Sheet: 297 x 297 mm    Sheet: 297 x 297 mm    Sheet: 297 x 297 mm		
<b>5</b>	Nom. dim. - cm/in	<b>2.5 x 2.5 / 1 x 1</b>	<b>5 x 5 / 2 x 2</b>	<b>10 x 10 / 4 x 4</b>
	Work size	23 x 23 x 6.5 mm	47 x 47 x 6.5 mm	97 x 97 x 6.5 mm
<b>6</b>	Surface	smooth, matt	smooth, matt	smooth, matt
	m <sup>2</sup> - pieces	11 sheets	11 sheets	11 sheets
	m <sup>2</sup> - kg	12.100	12.331	13.101
<b>7</b>	Bundle - pieces	11 sheets	11 sheets	11 sheets
	Bundle - m <sup>2</sup>	1.000	1.000	1.000
	Bundle - kg	12.100	12.331	13.101
	Pallet - m <sup>2</sup>	48.000	64.000	64.000
	Pallet - kg	580.800	789.184	838.464
<b>8</b>	Product standard	Bib	Bib	Bib
	Slip resistance <b>9</b>	R10/B	R10/B	R10/B
<b>10</b>	Stress group	1	1	1
	neutral 10			
<b>13</b>		<b>4 902-2120H 11</b>	<b>905-2120H 14</b>	<b>910-2120H</b>
	(active white) <b>15</b> 	Price gr. <b>A238</b> (m <sup>2</sup> )	Price gr. <b>A205</b> (m <sup>2</sup> )	Price gr. <b>A166</b> (m <sup>2</sup> )

## U3 im Umschlag

The following symbols are used:

-  Hytect surface (for description, refer to pages 10 and 527)
-  Protecta surface upgrading (for description, refer to page 527)
-  Novelties
-  no shodfoot traffic
-  Rectified
-  Conically rectified
-  Rectified wall tiles with rounded, bevelled edges
-  Make-to-order production: return and/or cancellation of ordered products not possible
-  Orientation aid for the blind analogue to the requirements of DIN 32984
-  Frost-resistant
-  **R9** Slip-resistant
-  **B** Slip-resistant / Barefoot areas
-  Made in Germany
-  Glued thermoplastically
-  also available in other colors
-  6 mm tile



Management System  
ISO 9001:2015



www.tuv.com  
ID 9000027001

Agrob Buchtal Solar Ceramics GmbH  
Buchtal 1, D-92521 Schwarzenfeld  
Tel.: +49 (0) 94 35-391-0  
Fax: +49 (0) 94 35-391-34 52

E-Mail: [info@agrob-buchtal.de](mailto:info@agrob-buchtal.de)  
Internet: [www.agrob-buchtal.de](http://www.agrob-buchtal.de)

01/2025, [www.assenmacher.net](http://www.assenmacher.net)

The publisher does not assume liability for misprints.  
Color deviations when compared to the original products may occur as a result of printing.

