



Programme of Delivery

2025

Solid Ground

The Solid Ground series, designed in collaboration with Hadi Teherani, combines concrete and travertine to create an elegant design. With modern colors, modular formats and 145 cm long stair tiles, it offers creative possibilities for residential and commercial spaces – ideal for architects, planners and builders. For further information, refer to the pages 412 - 423.



Ocean

Ocean offers a fascinating color range for pools, spas and wellness. Inspired by water and nature, iridescent shades of blue, green and sand combine vibrancy with elegance. Perfect for atmospheric designs, complemented by versatile formats and the possibility of combination with other series. For further information, refer to the pages 316 - 321.

Streetlife Metallic

The Streetlife Metallic series combines urban coolness with the charm of lived-in surfaces and is reminiscent of brushed metal with traces of rust and oxidation. The powerful aesthetics and metallic colors create a timeless, urban flair, ideal for modern living concepts, lofts and public spaces. The tiles are available in versatile formats and robust thicknesses, and thus a perfect solution for private and commercial applications. For further information, refer to the pages 468 - 471.



Introduction	4 – 25
Product finder	26 – 35

Series A–Z

Alcina	38 – 45
Amano	46 – 49
Area Pro	50 – 77
Aruba	78 – 85
Ascona	86 – 99
Basic Stone	100 – 103
Basis	104 – 113
Basis 1	107 – 108
Basis 1+	109
Basis 2	110
Basis 3	111 – 112
Basis 4	113
Basis Pro	114 – 121
Orientation Aids for the Blind	122 – 127
Bliss	128 – 131
Cedra	132 – 139
Chroma	140 – 149
Chroma non-slip	150 – 159
Chroma unglazed	160 – 167
Concrete	168 – 171
Craft	172 – 177
Craft Extended	178 – 181
District	182 – 185
Eladuct + Keraion ELA	186 – 189
Emotion	190 – 195
Emotion Grip	196 – 201
Evalia	202 – 207
Factory	208 – 217
Ferrum	218 – 221
Fresh	222 – 235
Karl	236 – 241
Keraion - Special Glazes for Operating Theatres	242 – 245
Like	246 – 255
Loop	256 – 263
Lounge	264 – 273
Mandalay	274 – 277
Mando	278 – 283
Marble & More	284 – 287
Natural Ceramics	288 – 291
New Market	292 – 299
Nivella	300 – 301
Nova	302 – 309

Oak	310 – 315
NEW Ocean	316 – 321
Pattern	322 – 333
Pizarro	334 – 337
Plural	338 – 357
Plural non-slip	358 – 365
Plural unglazed	366 – 371
Quarzit	372 – 379
Savona	380 – 385
Senja Pure	386 – 391
Sento	392 – 399
Sierra	400 – 405
Skill	406 – 411
NEW Solid Ground	412 – 423
Solid Rock	424 – 431
NEW Stone Concept	432 – 437
NEW Stone Duo	438 – 445
Stories	446 – 455
NEW Strata	456 – 467
NEW Streetlife Metallic	468 – 471
Trio	472 – 481
Unique	482 – 487
Valley	488 – 493
Walden	494 – 497

Index/Technical Information

Article numbers	500 – 510
Models	511 – 512
Model numbers	513
Classification according to NCS/RAL Lightness values	514 – 515
Luminance contrast	516 – 519
Technical Information	520 – 539
World-wide distribution network	542 – 543
Comments	546 – 547

We understand. Since 1755.



Reliable

We know a lot about tiles. We have been working with clay since 1755 and have a comprehensive understanding of our material and the production of highest-quality stoneware, porcelain stoneware and earthenware. In our four German production facilities, we are constantly refining our recipes for mixing clay, feldspar, fireclay, kaolin and water. As a natural material which transitions from plastic to solid in carefully monitored firing processes, clay offers endless possibilities for creating ceramic products that help make architecture durable, sustainable and beautiful.



Versatile

Our products are used far and wide. Indoors and outdoors. From private homes to museums. From hotels to hospitals. From restaurants to offices. From shops to swimming pools. From bathroom floors to building facades. We offer floor, wall and facade tiles for every purpose. And we produce all kinds of special elements to meet almost any specific requirement, whether it's a custom edge for a swimming pool or an integrated orientation aid for visually impaired people. Our tiles can be found everywhere, world-wide.

Cooperative

No matter how good our products are, we believe that only their application brings out their qualities. That's why we value collaboration and are happy to share our knowledge to find the best solution for each of your architectural projects. Where our standard products reach their limits, we develop customized solutions. Special productions are our speciality. We have the expertise and experience to support architects from the invitation to bid to the project completion. Tell us how we can help you. Contact us if you want to hear what we know.

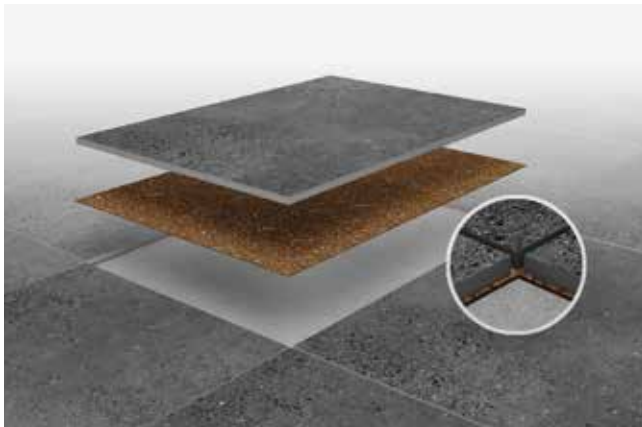
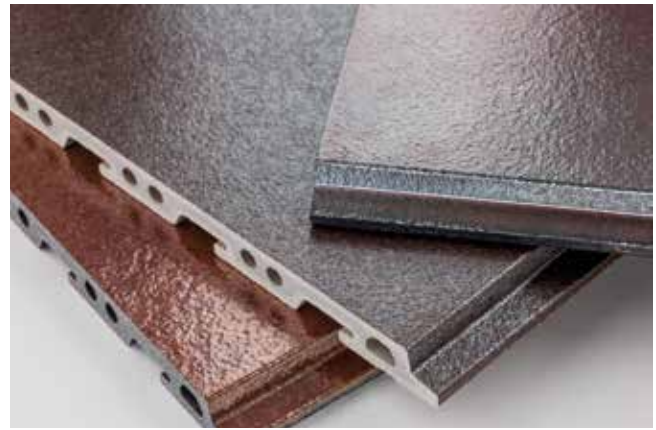

Innovative

We know how to produce great tiles. Yet we work continuously to make them even better. Craftsmanship and new technologies are combined to create innovative slip-resistant surfaces for wet areas and to develop new and simple methods for working with ceramics, such as Drytile, which allows **adhesive-free installation**. We invest in health and hygiene, as demonstrated by our sustainable Hytect technology, which is used in almost every product we make. In addition to developing innovations in all areas, we are proud of offering tailor-made new solutions and helping architects to realize their best ideas.

Sustainable

The requirements to be met in the construction sector are continuously increasing. Building owners, planners and users making new demands that increasingly take future developments into account. Energy efficiency, resource conservation and climate change are the key factors in this context, that have a decisive influence. Agrob Buchtal is aware of its responsibility for sustainable building and supports not only the idea of sustainable building through its membership in the German association for sustainable building (Deutsche Gesellschaft für Nachhaltiges Bauen (DGNB)). Early on, we committed, at the industry level, to making all ecological product data important for the planning process of sustainable buildings transparent – within the framework of an Environmental Product Declaration (EPD) according to ISO 14025. Whether a building meets sustainability criteria can be objectively assessed using certification systems. For this, specific product information must be available and documented.



We are on site.

Produced in Germany
and available world-wide.

DSA Deutsche Steinzeug America, Inc



You will find your sales contacts (D+A+CH) on the pages 542-543.
Or please send us a contact inquiry via the website www.agrob-buchtal.com.



Bremerhaven

Alfter-Witterschlick

Ötzingen

Sinzig

Schwarzenfeld

Deutsche Steinzeug Schweiz AG

Deutsche Steinzeug France S.A.R.L.

Modular color systems

Modular color systems are designed for complex requirements in all areas of architectural ceramics. The new Area Pro series is a real all-rounder with its extensive product range of tiles and accessories. It combines sophisticated design with high functionality and thus offers well thought-out solutions for the most diverse areas of application. As a perfect synthesis of function and aesthetics, Emotion supports consistent room concepts for functional and representative areas. With 50 colors matched to one another and a wide variety of formats, Chroma and Plural promote the varied, room-spanning design of wall and floor surfaces. Fresh and Loop offer particularly exciting colors and formats in the mosaic sector.



Area Pro: naturally intuitive

Good design always conveys an intuitive approach to its use – and thus, designing with Area Pro is also easy. With its earthy shades and pleasant haptics, the wide range of products immediately inspires ideas for their use. The series inspired by fine-grained, layered limestone blends in effortlessly and stands out at the same time. This makes the tiles and their accessories perfect all-rounders in almost every ambience. The series already exudes the potential to become a classic.

Chroma: the color concept: mixing and combining

When it comes to color design in the pool area, blue is usually the color of choice. However, Chroma also offers warm and neutral shades from the color system inspired by nature – for classics rich in variation, individual accents and a holistic look.

The color scales are divided into six groups: warm, earthy, cool, fresh and sunny shades move around a group of muted, neutral grey shades. Each group contains colors which can be easily combined, both within the group and with other groups. In this way, a consistent and uniform design can always be created.



Plural: colorful and flexible

The color range specially developed for Plural comprises 50 colors matched to one another. Whether glazed or unglazed, earthenware, stoneware or porcelain stoneware – the narrow 3 mm joint is just as standard with Plural as the pollutant-reducing Hytect coating and the design in various slip-resistance classes. Thus, Plural can be used in many indoor and outdoor areas: from the facade to the floor, from the underground station to the wellness landscape.





Emotion: modular and timeless

With colors and surfaces matched to one another, slip-resistant tiles from R9 to R12V4 and formats from 30 x 30 to 60 x 60 cm, the tiles of the Emotion series offer architects a great deal of freedom. Emotion ensures good design particularly in areas where transitions between different slip-resistance requirements are needed. This makes front cooking in direct view of restaurant guests just as feasible as the seamless and aesthetically pleasing combination of workshop and showroom in a car dealership.

Fresh: fresh and modern

Fresh offers a harmonious range of modern, fresh colors in the popular mosaic formats of 2.5 x 2.5 cm and 5 x 5 cm, allowing for unique yet easily achievable designs. A particularly practical feature: The tiles come with color-coordinated, slip-resistant mosaics in R10/B and R11/C.

Color gradients accentuate selected areas, liven up the overall aesthetic and stage artistic interplays with homogeneous tiled surfaces. When used as cladding for individual elements such as columns, partition walls or bar counters, they bring their own rhythm to the room.



Loop: fine and round

The secret of the depth, luminosity and durability of the colors is the glaze. Up to ten layers are applied to the stoneware and fired in to make them abrasion-proof. We create the glazes ourselves – with selected raw materials. This is how mosaics of radiant, lasting beauty are created.

Loop offers a wide spectrum of intensive and muted color shades ranging from blues and greens to bold yellows, oranges, and reds, as well as gray and brown tones, all the way to deep black. Delicate transparency for lightness and timelessness, luminous richness for accent and expression.

Innovative.

Hytect – the air is clean

The Hytect technology is securely baked into the ceramic surface at high temperatures. When light falls on the tiles coated in this way, active oxygen is released through photocatalysis. This process effectively combats bacteria and mould. At the same time, Hytect tiles naturally eutralize air pollutants.

And because they are also hydrophilic, dirt and grease hardly adhere to them. All these effects remain unchanged over the entire service life of the tiles. And thanks to a wide range of products, Hytect ceramics can be used in a wide variety of areas. Our products refined with our Hytect technology are marked with the Hytect logo.

The effects

Extremely easy to clean

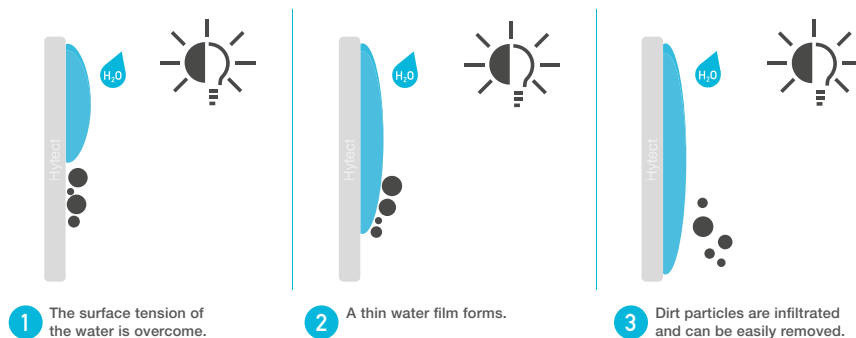

Effective against fungi and bacteria

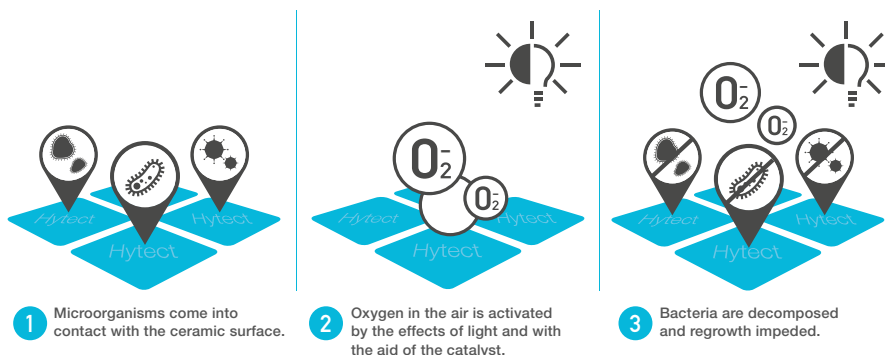

Active elimination of air pollutants

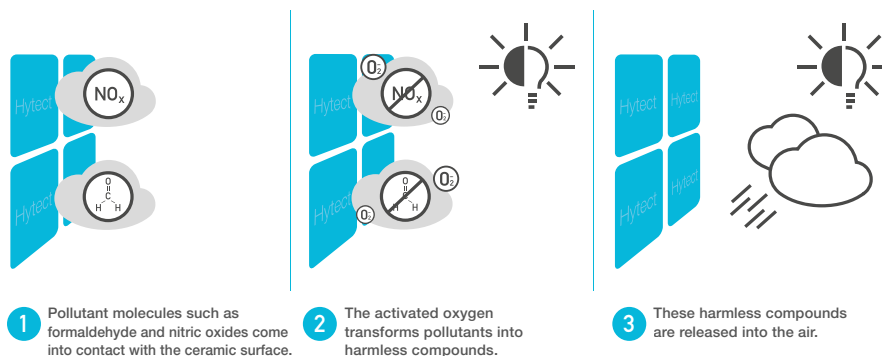

To the Hytect film:



Further information:
www.hytect.com



Slip-resistant tiles for all areas of application

Slips, trips, and missteps are the primary cause of accidents in most companies and facilities. Slip-resistant tiles, marked with the GRIP quality seal, are one of our core competences. Since the introduction of the first slip-resistant tiles in the 1930s, we have continuously further developed this innovation through intensive research.

The results include prestigious awards for outstandingly designed surfaces, functional advancements such as quiet and vibration-free movement, and micro-rough special glazes for barefoot areas in swimming pools. The quality of our slip-resistant tiles is ensured through continuous internal laboratory testing and regularly and independently monitored by external institutes and participation in inter-laboratory comparisons with accredited test laboratories.

The latest innovation in slip-resistant tiles: R12V4

In collaboration with the German designer Sebastian Herkner, a special anti-slip surface was developed for Area Pro. Sebastian Herkner was looking for a pattern that appears spontaneous while still maintaining a certain logic. This is how he came up with the repeating, trapezoidal rectangles and the pattern that can be continued in all four directions. Area Pro is available with various slip-resistant surfaces, including Grid, with a slip resistance of R12V4. None of the slip-resistant surfaces compromise the aesthetics of the tiles. They are also available for large-format tiles, which, due to their properties, can also be used in commercial kitchens.



Designer Sebastian Herkner develops the slip-resistant surface "Grid".



Functionality and beauty combined:
the R12V4 surface of the Area Pro series.



The design of Grid.

The in-house planning department

Efficient support for seven decades

At Agrob Buchtal, high-quality products and expert services go hand in hand. In this way, planners and architects who use our products have had access to our proven architect service since 1952, fostering a collaborative partnership.

A dedicated team of qualified technicians, engineers, architects, designers and color experts ensures swift and seamless realization of individual concepts. Since these experts are not only specialized advisers but also carry out numerous routine tasks, Agrob Buchtal customers can completely concentrate on the realization of their creative ideas. The range of services includes installation plans, quantity calculations, tender specifications, and project-specific technical consulting. Upon request, an on-site contact person is available.



Individual production

for special requirements.

More than standard solutions

Creative architects and planners need unlimited design freedom to bring their ideas to life.



Special colors

Chosen individually or custom-created from nearly 20,000 glaze recipes in any desired shade. This also applies to Corporate Colors that match a company's corporate design (CD).



Water-jet cutting technique

it allows for the precise shaping of ceramic tiles, including curved forms, which can be assembled according to design specifications.

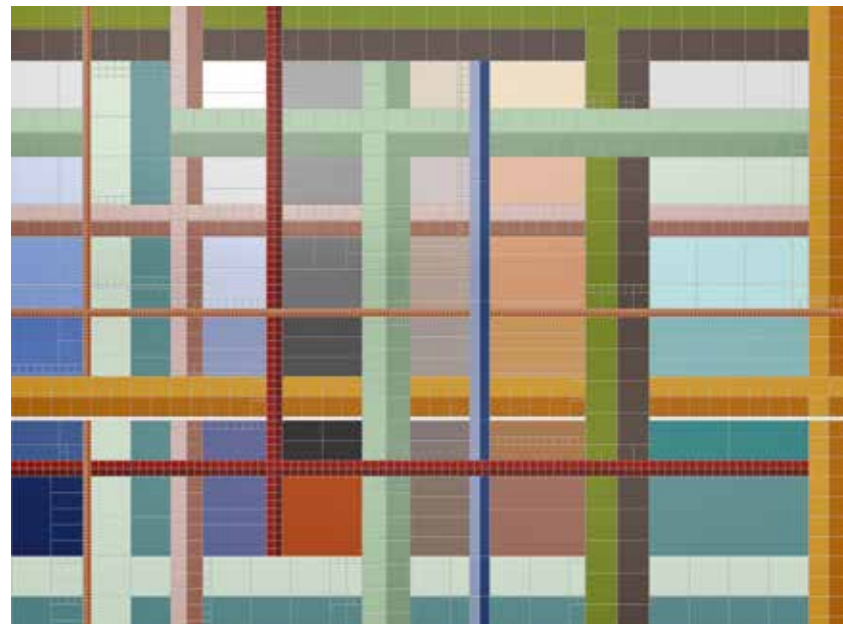

Special formats

These are in demand for both high-end new constructions and the renovation of historic buildings and are manufactured exactly according to the specifications of the architects.

Mosaic Designer

Free your mind

With the new mosaic planning tool, Agrob Buchtal expands the horizon for architects and interior designers with an unlimited range of solutions in terms of form, color and size. The digital service provides scope for new ideas and impresses with its excellent user experience thanks to its intuitive, almost playful usability. A tool with which Agrob Buchtal is revolutionizing the ancient art of mosaics and breathing new life into it.

By entering the desired basic parameters such as the dimensions of the mosaic surface, selection of product series, tile format and joint color, individual color gradients or color blends can be generated automatically. Depending on the size, the desired design is generated and visualized on the screen in the shortest possible time.

Many small tiles are required for an area of 3 x 6 metres, for example. They are digitally arranged and designed in a flash. There is no size limits which makes the Mosaic Designer

from Agrob Buchtal a creative accelerator, especially for the design of swimming pools and wellness facilities, restaurants, hotels, schools and public spaces, including underground stations.

There is a choice of the three mosaic series Loop, Fresh and Plural, which are ideal as pure color system series without surfaces such as wood, concrete, marble or the like and offer a wide spectrum of tonal values for the design. Each design can be saved as a project or sent immediately to Agrob Buchtal as an inquiry.

In addition to graphic gradients and color mixtures, the Mosaic Designer can also implement individual motifs. Images and photos can be directly uploaded using the upload function.

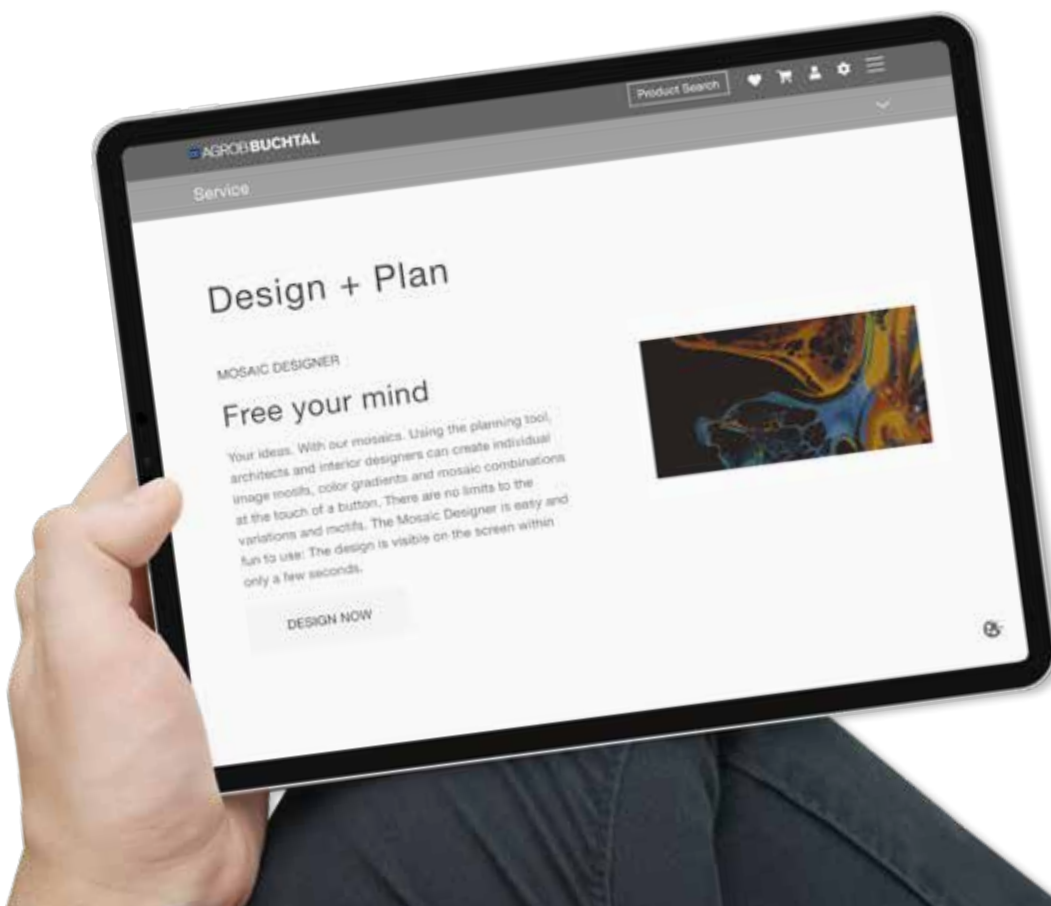

directly to the Mosaic Designer

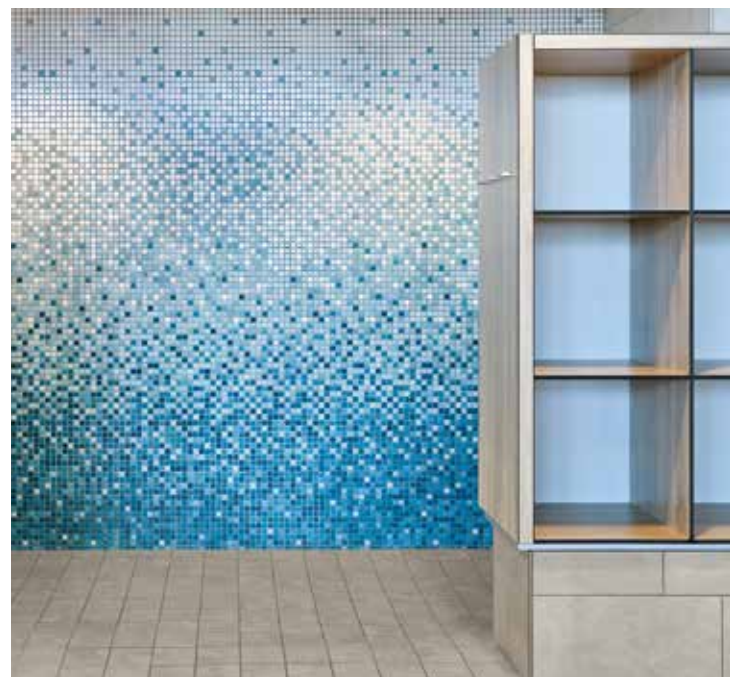
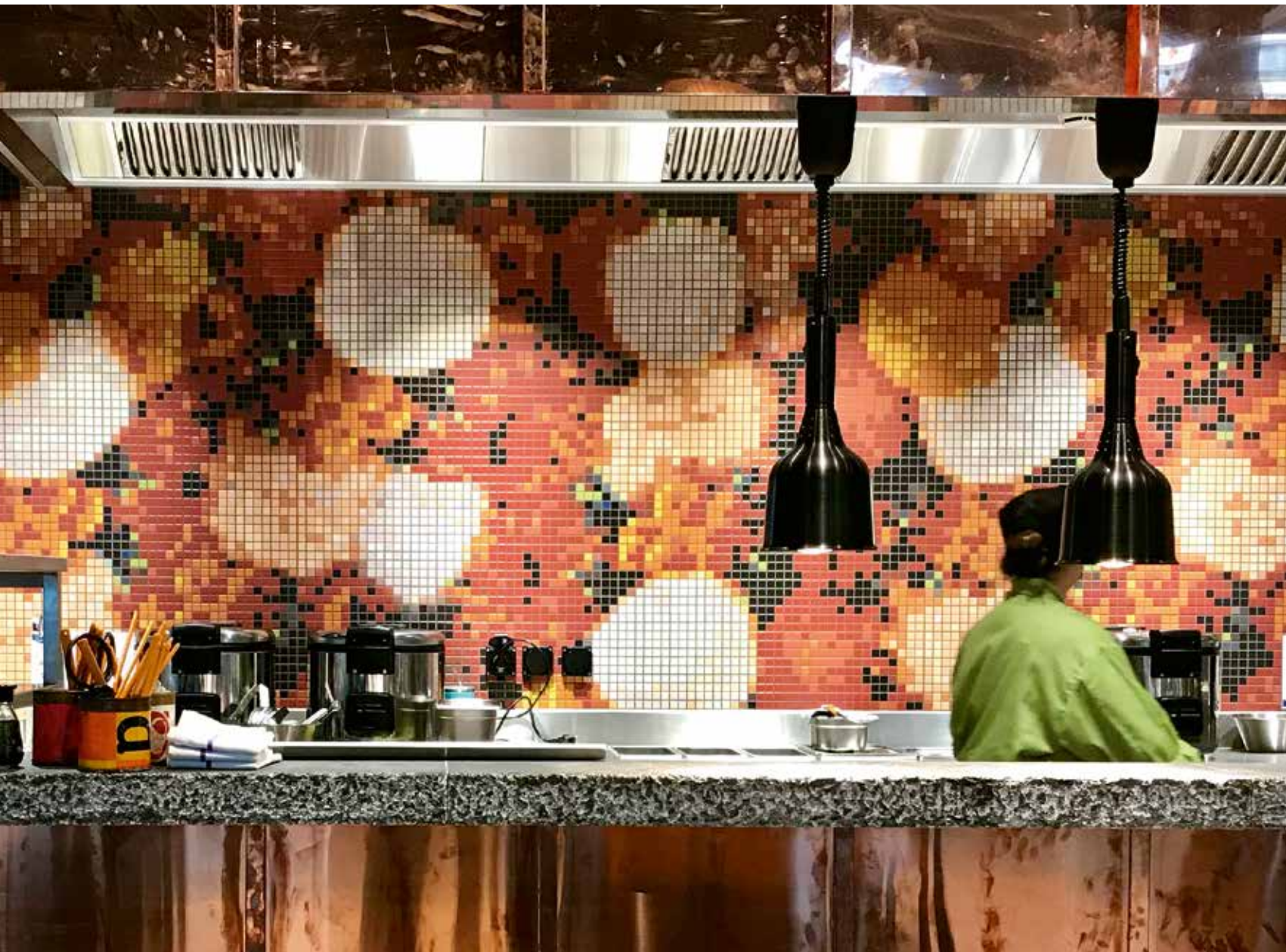

We develop product solutions for all
areas of application



Retail

Retail concepts require high-quality, authentic materials which are robust and can withstand heavy loads, such as our extra thick tiles or special product solutions such as the Drytile floor tile coated with cork, which is laid dry. This saves an enormous amount of time and is thus an economic advantage for the construction of new buildings or renovation.

Drytile – As fast as your business



Extra thick tiles





Hotel + Gastronomy

Hotels are temporary homes. Well-thought-out interior design helps guests feel at home. Authentic materials that create atmosphere and highlight the special charm of the place are in demand. Tiles have been a popular and versatile design element in architecture for centuries. High-quality ceramics are durable, resistant to wear, color-fast, easy to clean and therefore economical.

Colorful tiles as a design statement



Mosaics for wellness areas





Health + Care

In health and care facilities, the well-being of patients is paramount – whether in patient rooms, operating theatres, treatment rooms, large kitchens, laboratories or therapy baths. The standards of hygiene, cleanliness and accessibility are very high. At the same time, operators want sophisticated interior design with a calming and friendly atmosphere. This positively impacts patients' well-being and supports their recovery. We also provide tailored solutions to meet the unique requirements of health care facilities: Ceramics with a specialized glaze reduce disruptive reflections—ideal for operating rooms and areas where laser technology is used. Special solutions for therapy pools combine functionality with beautiful design.

Therapy areas



Ceramics against germs





Education

Schools, kindergartens, and universities are places of education, just like political, artistic, or musical institutions. An attractively designed environment increases the willingness to learn and has an inspiring effect. And when people feel comfortable, they like to come back. Color is an important element for giving rooms atmosphere and expression. In combination with material and texture, a positive, stimulating environment is created in day-care centres or primary schools, for example. The depth of color, brilliance and expressiveness of ceramics are long-lasting. High-quality ceramics withstands the demands of constant public traffic for decades.

Modular color systems



Orientation aid for the blind

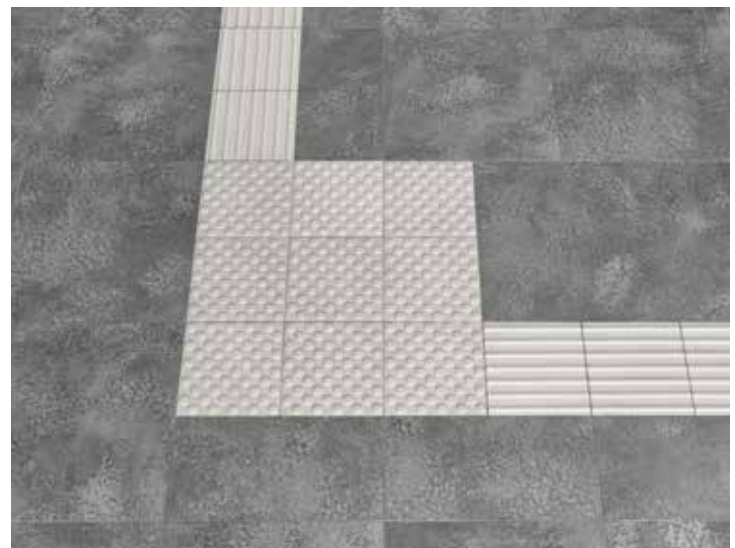



Industry + Infrastructure

The planning and execution of infrastructure buildings are challenging. Buildings such as railway stations, underground stations, tunnels, or airports should be multifunctional, visually appealing, and integrate seamlessly into the cityscape. Thousands of people come together in these areas every day. High-traffic areas require slip-resistant, durable, low-maintenance building materials, as well as easy-to-clean surfaces. This is where the Hytect tile comes in useful. The patented surface coating activates a natural process that purifies the air and neutralizes nitrogen oxides and odours. Unwanted graffiti is also demonstrably easy to remove. Special products, such as orientation aids for the blind, ensure accessibility and support barrier-free design.





Pool + Spa

The conception of contemporary pool architecture is complex and must meet high demands. And not only in terms of design: whether sports, leisure and adventure pools, therapy pools, private and hotel pools, sports and competition pools – they all have to be safe, easy to clean and inexpensive to maintain. Tiles meet these functional requirements: for example, with slip-resistant special surfaces ensuring a safe foothold even when wet. Modularly combinable tiles and special pieces are important for a consistent design from the pool and pool surround to all adjacent areas such as showers, saunas, changing rooms or restaurants.

Further information on the products can be found in the Pool + Spa programme of delivery.

Consistent design in all pool areas



Color gradients



Indoors and outdoors





Facade

The facade is more than a protective outer shell. It covers the building like a dress. Its design not only shapes the building itself, but also often has a visible effect on the urban environment. As a building material which has been tried and tested for thousands of years, ceramics also has ideal properties for the facade. It is non-combustible, resistant to chemicals, light-fast, pressure-, impact- and scratch-resistant. In addition, it is biologically safe for buildings, offers an unlimited service life, and is fully recyclable. Design possibilities emerge from the interplay of color, surface, format, and shape in all variations: bold, vibrant tones or subdued monochromatic shades. Glazed, unglazed, matt or glossy surfaces. Large-size panels, narrow oblong formats or mosaics for organic shapes. Three-dimensional shapes, baguettes or tubes.

KerAion®



KeraShape®



KeraTwin®



KeraJoin®



KeraYou®





Living

Wall and floor coverings significantly characterize the overall impression of rooms. When planning contemporary bathrooms and living spaces, design usually is the top priority when it comes to choosing wall and floor coverings. At the same time, the materials used to furnish the home office or dining room, hallway, living room or bathroom should also be hard-wearing and durable. It is important to create living comfort without compromises, ecologically sustainable, easy to clean and barrier-free. We offer products which meet these requirements and create smart additional benefits with the advantages of the antibacterial Hytect surface. From the mosaic up to large formats.

Bathrooms





Kitchen

Living room



Terraces



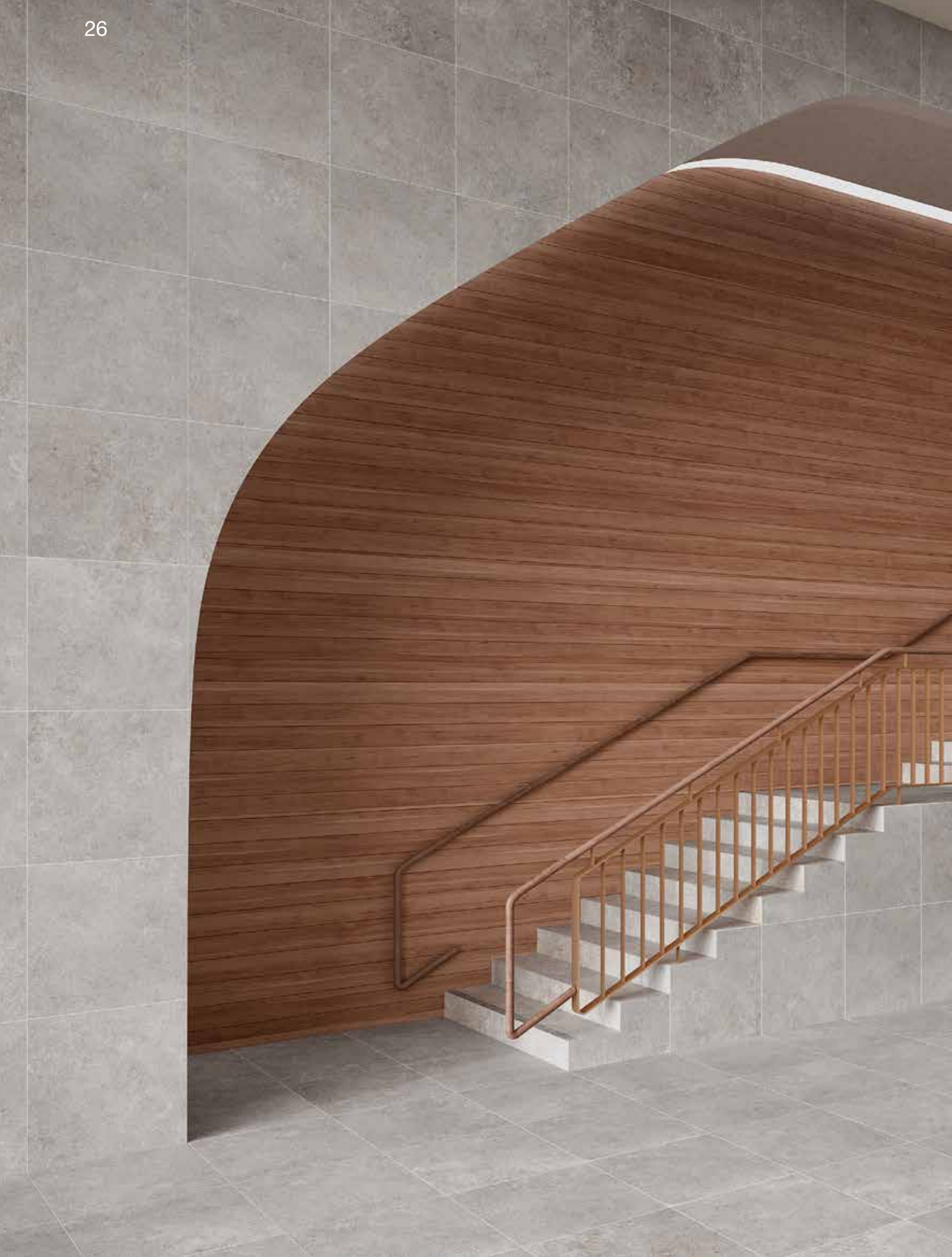



Product Finder



Series from A to Z





Warm and natural

With its naturally textured surfaces, Alcina offers an elegant range of earthy and warm shades for walls and floors in living and wet areas. Alcina can easily be combined with a variety of living styles. The delicately colored wall tiles feature a Hytect surface. Floor tiles in various colors and formats create bold or subtle contrasts. The Sola décor adds stylish variety across all floor colors. This extensive tile range is complemented by matching skirtings, non-slip 5 x 5 cm mosaics, and patio tiles.

Rendering / architect: Stellwerk architekten

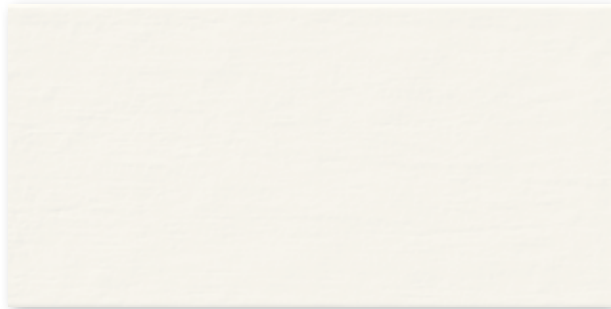

Wall tile 30 x 60 cm, 12 x 24 in, white, structured



Wall tile 30 x 60 cm, 12 x 24 in, beige, structured

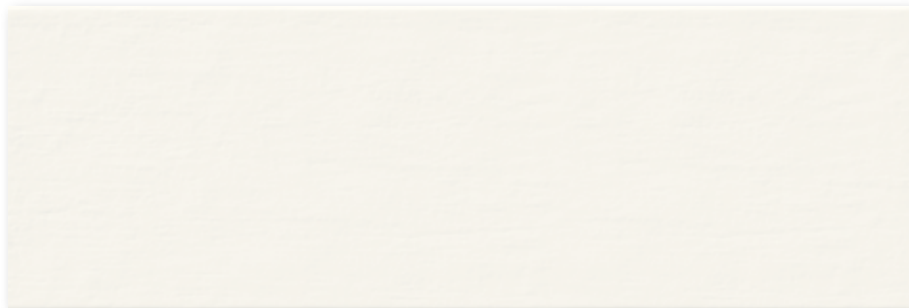

Wall tile 30 x 90 cm, 12 x 36 in, white, structured



Wall tile 30 x 90 cm, 12 x 36 in, beige, structured

Decoration Elements



Border Sola 24.3 x 43.8 cm, crema, structured

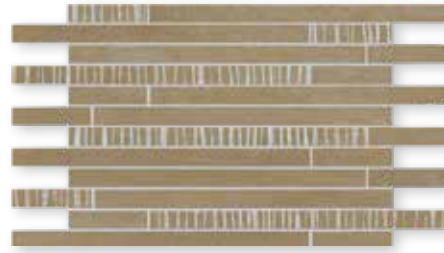

Border Sola 24.3 x 43.8 cm, clay-brown, structured



Border Sola 24.3 x 43.8 cm, pebble-grey, structured

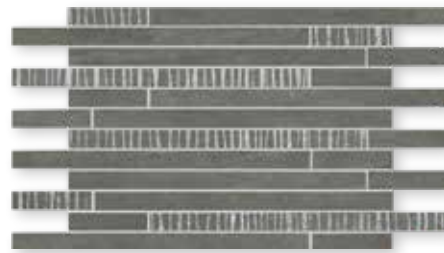

Border Sola 24.3 x 43.8 cm, basalt, structured

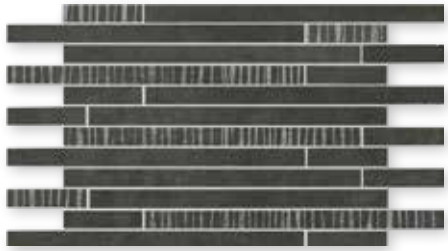

Border Sola 24.3 x 43.8 cm, graphite, structured

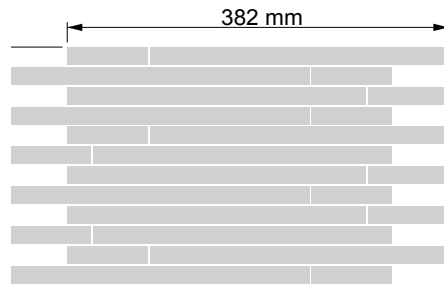

Border: Glass fibre net on reverse side
 Sheet: 240 x 435 mm

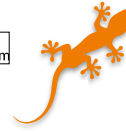

R10/A+B



crema



clay-brown



pebble-grey



basalt

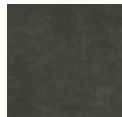

graphite



Floor tile 30 x 60 cm, 12 x 24 in, structured, R10/A+B



Floor tile 60 x 60 cm, 24 x 24 in, structured, R10/A+B



Skirting, cut 7 x 60 cm, 2 13/16 x 24 in, structured

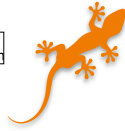

R10/A+B R11/B



Mosaic 5 x 5 cm, 2 x 2 in



Mosaic sheet 30 x 30 cm, 12 x 12 in, crema, structured, R10/A+B

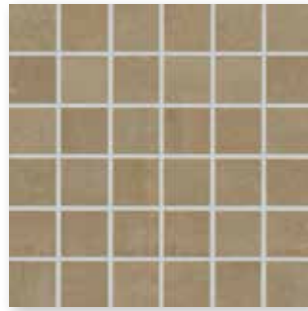

Mosaic sheet 30 x 30 cm, 12 x 12 in, clay-brown, structured, R10/A+B



Mosaic sheet 30 x 30 cm, 12 x 12 in, pebble-grey, structured, R10/A+B

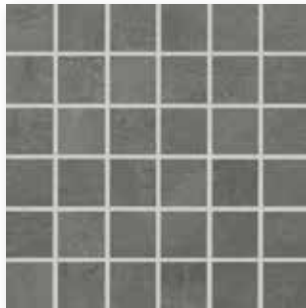

Mosaic sheet 30 x 30 cm, 12 x 12 in, basalt, structured, R10/A+B

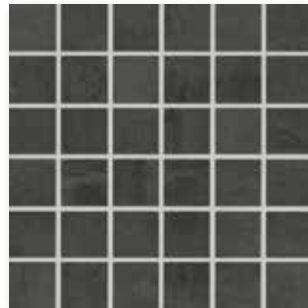

Mosaic sheet 30 x 30 cm, 12 x 12 in, graphite, structured, R10/A+B

Mosaic: glass fibre net on reverse side,
Sheet: 297 x 297 mm

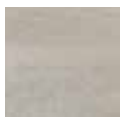

pebble-grey



basalt

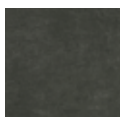

graphite



Patio tile 60 x 60 cm, 24 x 24 in, structured, R11/B

Wall Tiles⁵

30 x 60 cm



30 x 90 cm¹

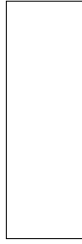

Decoration Elements^{2/3/4/6/7}

24,3 x 43,8 cm



Border Sola,
Sheet: 240 x 435 mm

Nom. dim. - cm/in	30 x 60 / 12 x 24	30 x 90 / 12 x 36	24.3 x 43.8 / 10 x 18				
Work size	297 x 597 x 6 mm	297 x 897 x 6 mm	240 x 435 x 6 mm				
Surface	structured, silky-matt	structured, silky-matt	structured, matt				
m ² /m - pieces	5.556/m ²	3.704/m ²	2.639/m				
m ² /m - kg	10.279/m ²	10.400/m ²	3.077/m				
Bundle - pieces	13	8	3				
Bundle - m ² /m	2.340 m ²	2.160 m ²	1.137 m				
Bundle - kg	24.050	22.464	3.498				
Pallet - m ²	112.311	51.836					
Pallet - kg	1.154.400	539.136					
Product standard	BIII	BIII	Bla				
white	203435H Price gr. C68 (m ²)	323437H Price gr. C134 (m ²)					
beige	203436H Price gr. C68 (m ²)	323438H Price gr. C134 (m ²)					
crema			203439 Price gr. C510 (pce.)				
clay-brown			203440 Price gr. C510 (pce.)				
pebble-grey			203441 Price gr. C510 (pce.)				
basalt			203442 Price gr. C510 (pce.)				
graphite			203443 Price gr. C510 (pce.)				

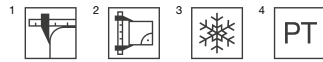

⁵ not frost-proof
⁶ Glass fibre net on reverse side
⁷ Decoration elements only available in full boxes.

Mosaic^{1/2}

Floor Tiles¹

Skirting, cut¹

Patio Tiles^{1/3/4}

5 x 5 cm



30 x 60 cm

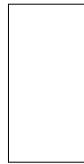

60 x 60 cm



7 x 60 cm



60 x 60 cm

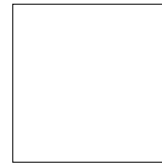

protected

Sheet: 297 x 297 mm

	5 x 5 / 2 x 2	30 x 60 / 12 x 24	60 x 60 / 24 x 24	7 x 60 / 2 13/16 x 24	60 x 60 / 24 x 24	Nom. dim. - cm/in
	47 x 47 x 6	297 x 597 x 6 mm	597 x 597 x 6 mm	70 x 597 x 6 mm	597 x 597 x 20 mm	Work size
	structured, matt	structured, matt	structured, matt	structured, matt	structured, matt	Surface
	11.111 sheets	5.556/m ²	2.778/m ²	1.667/m	2.778/m ²	m ² /m - pieces
	11.488/m ²	13.273/m ²	13.581/m ²	0.938/m	45.273/m ²	m ² /m - kg
	11 sheets	10	5	38	2	Bundle - pieces
	0.990 m ²	1.800 m ²	1.800 m ²	22.795 m	0.720 m ²	Bundle - m ² /m
	11.374	23.890	24.445	21.394	32.594	Bundle - kg
	35.640	71.994	64.795		21.598	Pallet - m ²
	409.464	955.600	880.020		977.820	Pallet - kg
	Bla	Bla	Bla	Bla	Bla	Product standard
	R10/A+B	R10/A+B	R10/A+B		R11/B	Slip resistance
	1	1	1		4	Stress group
	431480	431485	431490	431495		crema <input type="checkbox"/> V2
	Price gr. C308 (m ²)	Price gr. C98 (m ²)	Price gr. C107 (m ²)	Price gr. C440 (pce.)		
	431481	431486	431491	431496		clay-brown <input type="checkbox"/> V2
	Price gr. C308 (m ²)	Price gr. C98 (m ²)	Price gr. C107 (m ²)	Price gr. C440 (pce.)		
	431482	431487	431492	431497	434983H	pebble-grey <input type="checkbox"/> V2
	Price gr. C308 (m ²)	Price gr. C98 (m ²)	Price gr. C107 (m ²)	Price gr. C440 (pce.)	Price gr. C200 (m ²)	
	431483	431488	431493	431498	434984H	basalt <input type="checkbox"/> V2
	Price gr. C308 (m ²)	Price gr. C98 (m ²)	Price gr. C107 (m ²)	Price gr. C440 (pce.)	Price gr. C200 (m ²)	
	431484	431489	431494	431499	434985H	graphite <input type="checkbox"/> V2
	Price gr. C308 (m ²)	Price gr. C98 (m ²)	Price gr. C107 (m ²)	Price gr. C440 (pce.)	Price gr. C200 (m ²)	



¹ Glass fibre net on reverse side

² High weight only to carry with two persons.

³ Without Protecta upgrading; with Hytect coating







Deeply impressive and lively

Inspired by the movement of water, Amano features a finely textured relief surface. In combination with blurred glazes, Amano creates watercolor-like effects, adding natural charm and exclusive liveliness to the series. When light refracts on its glossy surface, Amano captivates with sparkling reflections.

Studio photo / Architect: Anne Doris Fluck / Photo: Jochen Stüber

Mosaic 2.5 x 2.5 cm, 1 x 1 in



Mosaic sheet 30 x 30 cm, 12 x 12 in, cream, relief

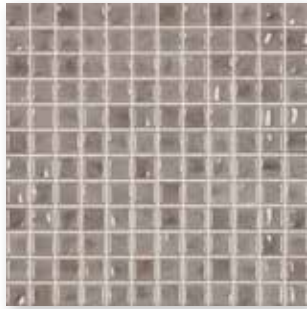

Mosaic sheet 30 x 30 cm, 12 x 12 in, taupe, relief

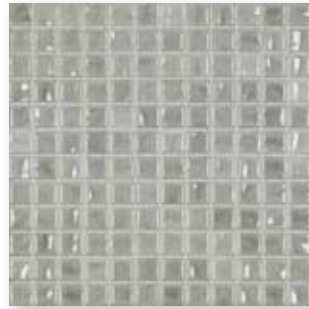

Mosaic sheet 30 x 30 cm, 12 x 12 in, light grey, relief

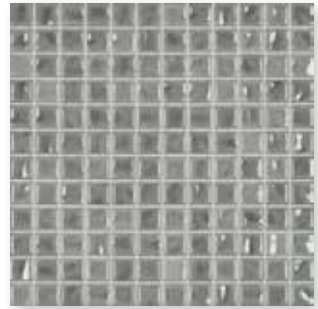

Mosaic sheet 30 x 30 cm, 12 x 12 in, medium grey, relief

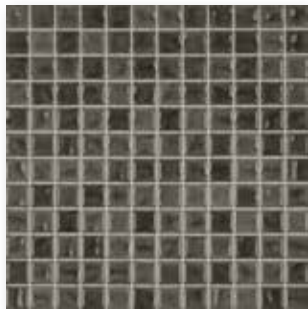

Mosaic sheet 30 x 30 cm, 12 x 12 in, anthracite, relief



Mosaic sheet 30 x 30 cm, 12 x 12 in, ice blue, relief

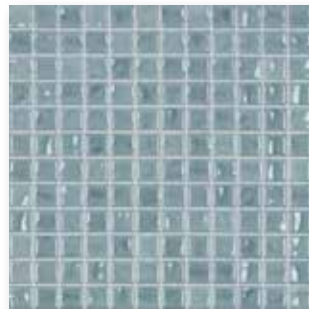

Mosaic sheet 30 x 30 cm, 12 x 12 in, silk blue, relief



Mosaic sheet 30 x 30 cm, 12 x 12 in, pure blue, relief



Mosaic sheet 30 x 30 cm, 12 x 12 in, metallic, relief

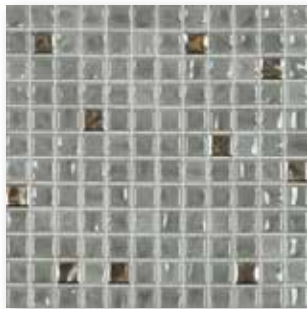

Mosaic sheet 30 x 30 cm, 12 x 12 in, medium grey-metallic-mix, relief



Mosaic sheet 30 x 30 cm, 12 x 12 in, taupe-metallic-mix, relief



Mosaics glued thermoplastically on back of Agrob Buchtal can be used not only in dry zones but also without any problems in underwater areas (e.g. swimming pools/whirlpools) as well as in permanently wet areas.

Mosaic

2.5 x 2.5 cm

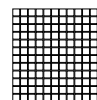

Sheet: 297 x 297 mm



						2.5 x 2.5 / 1 x 1	Nom. dim. - cm/in
						23 x 23 x 6.5 mm	Work size
						relief, glossy	Surface
						11 sheets	m ² - pieces
						12.100	m ² - kg
						11 sheets	Bundle - pieces
						1.000	Bundle - m ²
						12.100	Bundle - kg
						48.000	Pallet - m ²
						580.800	Pallet - kg
						Blb	Product standard
						1	Stress group
						41920H	3
						Price gr. A250 (m ²)	cream <input type="checkbox"/> V1
						41921H	3
						Price gr. A250 (m ²)	taupe <input type="checkbox"/> V1
						41922H	3
						Price gr. A250 (m ²)	light-grey <input type="checkbox"/> V1
						41923H	3
						Price gr. A250 (m ²)	medium grey <input type="checkbox"/> V1
						41924H	2
						Price gr. A250 (m ²)	anthracite <input type="checkbox"/> V1
						41925H	3
						Price gr. A250 (m ²)	ice blue <input type="checkbox"/> V1
						41926H	3
						Price gr. A250 (m ²)	silk blue <input type="checkbox"/> V1
						41927H	2
						Price gr. A250 (m ²)	pure blue <input type="checkbox"/> V1
						41928H ¹	2
						Price gr. A475 (pce.)	metallic <input type="checkbox"/> V2
						41929H ¹	2
						Price gr. A458 (pce.)	medium grey-metallic-mix <input type="checkbox"/> V2
						41930H ¹	2
						Price gr. A458 (pce.)	taupe-metallic-mix <input type="checkbox"/> V2

¹ Not or only to a limited extent resistant to acids and alkalis.



Rendering





Area Pro comes naturally

Like the best design objects that intuitively reveal their use, the Area Pro series feels natural and easy to work with. With its earthy colors and pleasant tactility, the wide range of ceramic products offered by Area Pro immediately spurs ideas on how to use them. The Area Pro series, which is inspired by fine-grained, layered limestone, seamlessly blends in while standing out. This makes these tiles and accessories reliable versatile all-rounders in nearly any setting. The series already exudes the potential



Rendering

to become a classic. Area Pro is the ceramic equivalent of the little black dress or a classic white shirt. Whether in office buildings, residential buildings or leisure facilities — like the fashion classics, the series is convincing in any environment and is thus a true all-rounder. All tiles can be installed in any direction. In addition, they impress with their versatility and a variety of formats and color shades. All Area Pro colors are coordinated with the Chroma and Plural series by Agrob Buchtal, allowing for diverse combinations. In addition, customized projects are also possible with this series.





Grid

In order to live up to its own claim of combining high functionality with sophisticated design, Agrob Buchtal engaged design shooting star Sebastian Herkner, who normally works for brands such as Thonet, Ligne Roset or Moroso. He created a completely new design for the surface of the highest slip-resistance class. The result: "the Grid".



Smart features

Always perfect grip



Area Pro is available with diverse slip-resistant surfaces, including Grid with a slip resistance of R12V4.

Sustainable, thin wall tiles



6 mm thin wall tiles require less material, reducing energy consumption during production and transport, as well as lowering weight.

Innovation Drytile



The Drytile system is available for floor tiles between 30 x 60 cm and 60 x 120 cm. Drytile is an innovative technology at which a cork compound is applied on the back of the tiles. Thanks to this cork layer, the tiles can be laid without the use of adhesive.

Hytect hygienic surface



Area Pro tiles feature sustainable Hytect surface, which makes them extremely easy to clean. In addition, Hytect protects ceramic tiles against bacteria and mould and neutralizes air pollutants and unpleasant odours.

Ceramic channel cover



For tiles laid around the pool in swimming baths, Agrob Buchtal offers the appropriate termination which ensures visual continuity: a channel cover with water-cut openings.



R10/A R10/B R11/B R11/C R12/C R12V4



Surfaces: Floor Tiles

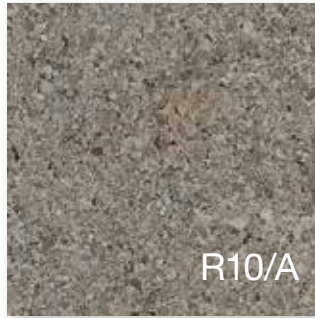

smooth

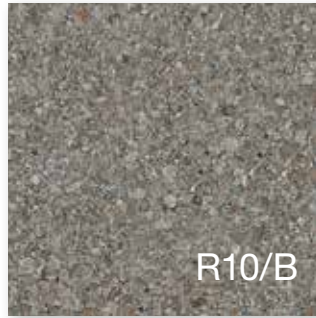

smooth

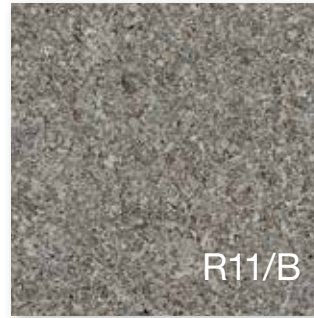

smooth

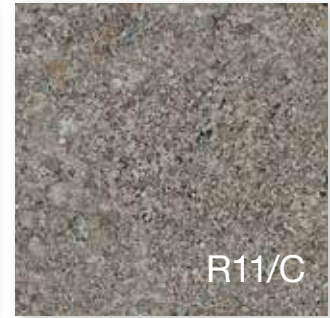

smooth



brick



platinum



clay



sand-grey



nutmeg



stone



sand



pebble



sand-beige



basalt



sand-white



anthracite



Floor tile 15 x 15 cm, 6 x 6 in, smooth, R10/B
Floor tile 15 x 15 cm, 6 x 6 in, smooth, R11/C



Floor tile 20 x 20 cm, 8 x 8 in, smooth, R10/A
Floor tile 20 x 20 cm, 8 x 8 in, Softcorn 2, R11/B
Floor tile 20 x 20 cm, 8 x 8 in, Perlstic, R12/C
Floor tile 20 x 20 cm, 8 x 8 in, Grid, R12V4



Floor tile 30 x 30 cm, 12 x 12 in, smooth, R10/A
Floor tile 30 x 30 cm, 12 x 12 in, smooth, R11/B

Mosaic

5 x 5 cm, 2 x 2 in



Mosaic sheet 30 x 30 cm, 12 x 12 in, smooth, R10/B

Mosaic

10 x 10 cm, 4 x 4 in



Mosaic sheet 30 x 30 cm, 12 x 12 in, smooth, R10/B
Mosaic sheet 30 x 30 cm, 12 x 12 in, smooth, R11/C



Mosaics glued thermoplastically on back of Agrob Buchtal can be used not only in dry zones but also without any problems in underwater areas (e.g. swimming pools/whirlpools) as well as in permanently wet areas (e.g. pool surrounds/showers).

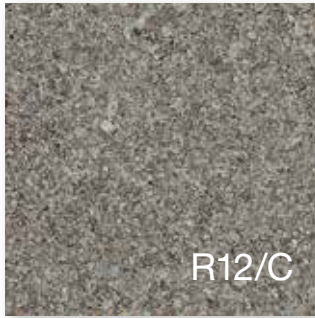

smooth

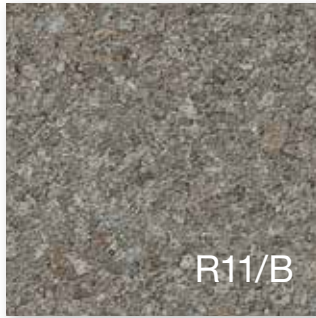

Softcorn 2

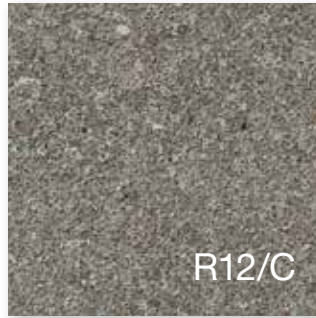

Perlstic



Grid



Oblong format 10 x 60 cm, 4 x 24 in, smooth, R10/A



Oblong format 15 x 60 cm, 6 x 24 in, smooth, R10/A



Floor tile 30 x 60 cm, 12 x 24 in, smooth, R10/A
 Floor tile 30 x 60 cm, 12 x 24 in, smooth, R11/B
 Floor tile 30 x 60 cm, 12 x 24 in, smooth, R12/C



Floor tile 60 x 60 cm, 24 x 24 in, smooth, R10/A
 Floor tile 60 x 60 cm, 24 x 24 in, smooth, R11/B
 Floor tile 60 x 60 cm, 24 x 24 in, Grid, R12V4



R10/A R11/B



brick

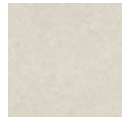

platinum



clay



sand-grey



nutmeg



stone



sand



pebble



sand-beige



basalt



sand-white



anthracite



Floor tile 90 x 90 cm, 36 x 36 in, smooth, R10/A



Floor tile 60 x 120 cm, 24 x 48 in, smooth, R10/A
Floor tile 60 x 120 cm, 24 x 48 in, smooth, R11/B

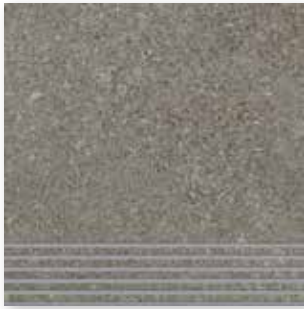

Stair tile 30 x 30 cm, 12 x 12 in,
(with grooves), smooth, R10/A

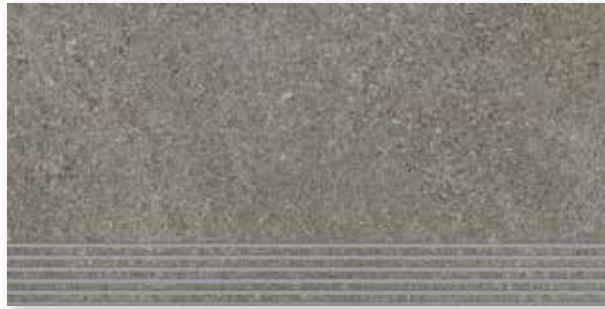

Stair tile 30 x 60 cm (with grooves), 12 x 24 in, smooth, R10/A



Stair tile with bevel 31 x 145 cm, 12.4 x 58 in, smooth, R10/A



Riser 28 x 145 cm, 11.2 x 58 in, smooth, R10/A



Stair edge 4 x 60 cm, 1.6 x 24 in, smooth, R10/A



R10/A R10/B R11 R11/B



brick

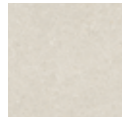

platinum



clay



sand-grey



nutmeg



stone



sand



pebble



sand-beige



basalt



sand-white



anthracite



Skirting, rounded 7 x 30 cm, 2.8 x 12 in, smooth



Skirting, rounded 7 x 60 cm, 2 13/16 x 24 in, smooth



Cove skirting 10 x 10 cm, 4 x 4 in, smooth, R10/A

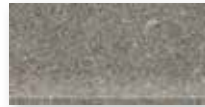

Cove skirting 10 x 10 cm, 4 x 8 in, smooth, R10/A



Cove skirting 10 x 10 cm, 4 x 12 in, smooth, R10/A



Cove skirting 10 x 60 cm, 4 x 24 in, smooth, R10/A



Internal corner for cove skirting, smooth



External corner for cove skirting, smooth



Shower tub system Strip 10 x 10 cm, 4 x 4 in, smooth, R10/B



Shower tub system Corner 10 x 10 cm, 4 x 4 in, smooth, R10/B



anthracite



platinum



Guide tile 30 x 30 cm, 12 x 12 in, ribbed structure, R11

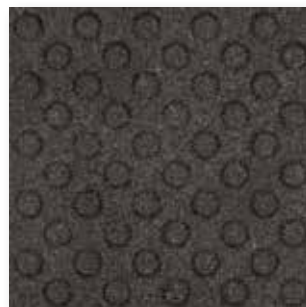

Guide tile 30 x 30 cm, 12 x 12 in, knob structure, R11



Guide tile 30 x 30 cm, 12 x 12 in, smooth, R11



sand



sand-beige



sand-grey



pebble



basalt



anthracite



Patio tile 60 x 60 cm, 24 x 24 in, smooth, R11/B



sand-beige



sand-grey



basalt



Patio tile decor Square, 60 x 60 cm, 24 x 24 in, smooth, R11/B

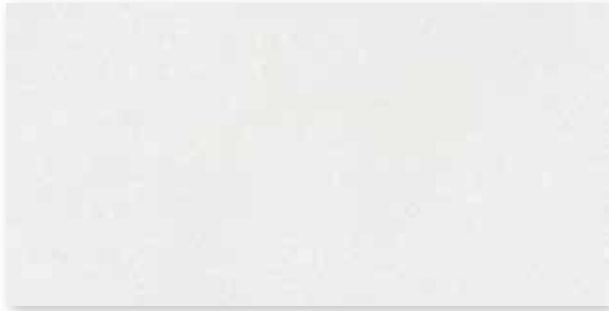

Wall tile 30 x 60 cm, 12 x 24 in, white, smooth



Wall tile 30 x 60 cm, 12 x 24 in, grey, smooth



Wall tile 30 x 60 cm, 12 x 24 in, beige, smooth

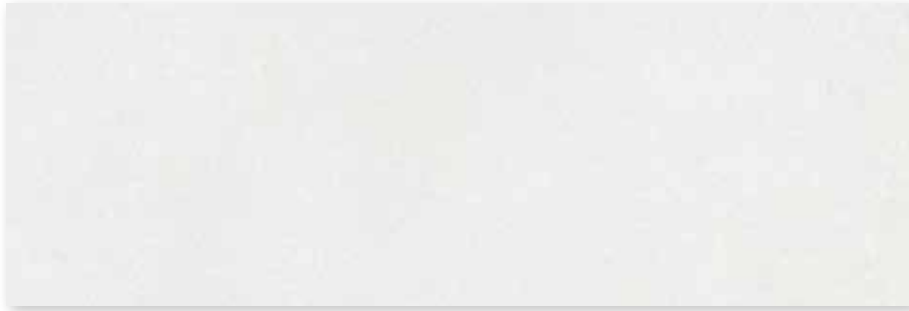

Wall tile 30 x 90 cm, 12 x 36 in, white, smooth



Wall tile 30 x 90 cm, 12 x 36 in, grey, smooth



Wall tile 30 x 90 cm, 12 x 36 in, beige, smooth



R11/B R11/C



brick



platinum



clay



sand-grey



nutmeg



stone



sand



pebble



sand-beige



basalt



sand-white



anthracite



Grooved tile 12.5 x 25 cm,
5 x 10 in, grooved, R11/C



Grooved tile 25 x 25 cm,
10 x 10 in, grooved, R11/C



Grooved tile 50 x 25 cm, 20 x 10 in, grooved, R11/C

Gutter Tiles (trough depth: 5 mm)



Gutter tile, 50 x 25 cm, 20 x 10 in,
smooth, R11/B



Gutter tile, mitred pair,
smooth, R11/B



Gutter tile with outlet
smooth, R11/B



Terminal piece
smooth, R11/B

Ceramic channel cover



Ceramic channel cover
corner solution 30 x 30 cm, 12 x 12 in

Ceramic channel cover
25 x 50 cm, 10 x 20 in



For details relating to gutter tiles and ceramic channel cover,
refer to the Pool + Spa programme of delivery.

Wall Tiles⁴

Mosaic^{1/2}

30 x 60 cm



30 x 90 cm³



5 x 5 cm



10 x 10 cm



10 x 10 cm



	Sheet 297 x 297 mm	Sheet 297 x 297 mm	Sheet 297 x 297 mm		
Nom. dim. - cm/in	30 x 60 / 12 x 24	30 x 90 / 12 x 36	5 x 5 / 2 x 2	10 x 10 / 4 x 4	10 x 10 / 4 x 4
Work size	297 x 597 x 6 mm	297 x 897 x 6 mm	47 x 47 x 6.5 mm	97 x 97 x 6.5 mm	97 x 97 x 6.5 mm
Surface	smooth, stone-matt	smooth, stone-matt	smooth, matt	smooth, matt	smooth, matt
m ² - pieces	5.556	3.704	11 sheets	11 sheets	11 sheets
m ² - kg	10.279	10.400	12.331	13.101	13.101
Bundle - pieces	13	8	11 sheets	11 sheets	11 sheets
Bundle - m ²	2.340	2.160	1.000	1.000	1.000
Bundle - kg	24.050	22.464	12.331	13.101	13.101
Pallet - m ²	112.311	51.836	64.000	64.000	64.000
Pallet - kg	1,154.400	539.136	789.184	838.464	838.464
Product standard	BIII	BIII	Bla	Bla	Bla
Slip resistance			R10/B	R10/B	R11/C
Stress group			1	1	1
white	203232H Price gr. A76 (m ²)	323235H Price gr. A166 (m ²)			
grey	203233H Price gr. A76 (m ²)	323236H Price gr. A166 (m ²)			
beige	203234H Price gr. A76 (m ²)	323237H Price gr. A166 (m ²)			
anthracite			430185H Price gr. A196 (m ²)	430220H Price gr. A148 (m ²)	430232H Price gr. A148 (m ²)
basalt			430186H Price gr. A196 (m ²)	430221H Price gr. A148 (m ²)	430233H Price gr. A148 (m ²)
pebble			430187H Price gr. A196 (m ²)	430222H Price gr. A148 (m ²)	430234H Price gr. A148 (m ²)
stone				430223H Price gr. A148 (m ²)	430235H Price gr. A148 (m ²)
sand-white				430224H Price gr. A148 (m ²)	430236H Price gr. A148 (m ²)
sand-grey			430188H Price gr. A196 (m ²)	430225H Price gr. A148 (m ²)	430237H Price gr. A148 (m ²)
sand			430189H Price gr. A196 (m ²)	430226H Price gr. A148 (m ²)	430238H Price gr. A148 (m ²)
nutmeg				430227H Price gr. A148 (m ²)	430239H Price gr. A148 (m ²)
platinum			435569H NEW Price gr. A196 (m ²)	430228H Price gr. A148 (m ²)	430240H Price gr. A148 (m ²)
sand-beige			430190H Price gr. A196 (m ²)	430229H Price gr. A148 (m ²)	430241H Price gr. A148 (m ²)
brick				430230H Price gr. A148 (m ²)	430242H Price gr. A148 (m ²)
clay				430231H Price gr. A148 (m ²)	430243H Price gr. A148 (m ²)

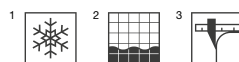

⁴ not frost-proof

Floor Tiles

15 x 15 cm



15 x 15 cm



20 x 20 cm



20 x 20 cm



20 x 20 cm



20 x 20 cm



	15 x 15 / 6 x 6	15 x 15 / 6 x 6	20 x 20 / 8 x 8	Softcorn 2 20 x 20 / 8 x 8	Perlstic 20 x 20 / 8 x 8	Grid 20 x 20 / 8 x 8	
	147 x 147 x 10.5 mm	147 x 147 x 10.5 mm	197 x 197 x 10.5 mm	197 x 197 x 10.5 mm	197 x 197 x 10.5 mm	197 x 197 x 10.5 mm	Nom. dim. - cm/in
	smooth, matt	smooth, matt	smooth, matt	structured, matt	fine-grained, matt	profiled, matt	Work size
	44.444	44.444	25.000	25.000	25.000	25.000	Surface
	23.111	23.111	22.900	22.900	22.900	22.900	m ² - pieces
	27	27	21	21	21	21	m ² - kg
	0.607	0.607	0.840	0.840	0.840	0.840	Bundle - pieces
	14.040	14.040	19.236	19.236	19.236	19.236	Bundle - m ²
	48.600	48.600	50.400	50.400	50.400	50.400	Bundle - kg
	1,123.200	1,123.200	1,154.160	1,154.160	1,154.160	1,154.160	Pallet - m ²
	Bla	Bla	Bla	Bla	Bla	Bla	Pallet - kg
	R10/B	R11/C	R10/A	R11/B	R12/C	R12V4	Product standard
	3	3	3	3	3	3	Slip resistance
	430244H	430256H	430268H	430274H	430280H	430286H	Stress group
	Price gr. A142 (m ²)	Price gr. A142 (m ²)	Price gr. A133 (m ²)	Price gr. A133 (m ²)	Price gr. A157 (m ²)	Price gr. A157 (m ²)	anthracite <input type="checkbox"/> V2
	430245H	430257H	430269H	430275H	430281H	430287H	basalt <input type="checkbox"/> V2
	Price gr. A142 (m ²)	Price gr. A142 (m ²)	Price gr. A133 (m ²)	Price gr. A133 (m ²)	Price gr. A157 (m ²)	Price gr. A157 (m ²)	pebble <input type="checkbox"/> V2
	430246H	430258H	430270H	430276H	430282H	430288H	sand-grey <input type="checkbox"/> V2
	Price gr. A142 (m ²)	Price gr. A142 (m ²)	Price gr. A133 (m ²)	Price gr. A133 (m ²)	Price gr. A157 (m ²)	Price gr. A157 (m ²)	sand <input type="checkbox"/> V2
	430249H	430261H	430271H	430277H	430283H	430289H	platinum <input type="checkbox"/> V2
	Price gr. A142 (m ²)	Price gr. A142 (m ²)	Price gr. A133 (m ²)	Price gr. A133 (m ²)	Price gr. A157 (m ²)	Price gr. A157 (m ²)	sand-beige <input type="checkbox"/> V2
	430250H	430262H	430272H	430278H	430284H	430290H	
	Price gr. A142 (m ²)	Price gr. A142 (m ²)	Price gr. A133 (m ²)	Price gr. A133 (m ²)	Price gr. A157 (m ²)	Price gr. A157 (m ²)	
	435570H NEW	435571H NEW	435572H NEW	435573H NEW	435574H NEW	435575H NEW	
	Price gr. A142 (m ²)	Price gr. A142 (m ²)	Price gr. A133 (m ²)	Price gr. A133 (m ²)	Price gr. A157 (m ²)	Price gr. A157 (m ²)	
	430253H	430265H	430273H	430279H	430285H	430291H	
	Price gr. A142 (m ²)	Price gr. A142 (m ²)	Price gr. A133 (m ²)	Price gr. A133 (m ²)	Price gr. A157 (m ²)	Price gr. A157 (m ²)	



Floor Tiles

30 x 30 cm



30 x 30 cm



10 x 60 cm^{1/2}



15 x 60 cm^{1/2}



30 x 60 cm¹

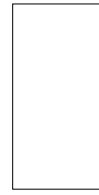

30 x 60 cm¹



30 x 60 cm¹

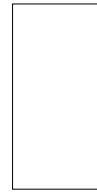

Oblong format

Oblong format

Nom. dim. - cm/in	30 x 30 / 12 x 12	30 x 30 / 12 x 12	10 x 60 / 4 x 24	15 x 60 / 6 x 24	30 x 60 / 12 x 24	30 x 60 / 12 x 24	30 x 60 / 12 x 24
Work size	297 x 297 x 10.5 mm	297 x 297 x 10.5 mm	97 x 597 x 10.5 mm	147 x 597 x 10.5 mm	297 x 597 x 10.5 mm	297 x 597 x 10.5 mm	297 x 597 x 10.5 mm
Surface	smooth, matt	smooth, matt	smooth, matt	smooth, matt	smooth, matt	smooth, matt	smooth, matt
m ² - pieces	11.111	11.111	16.667	11.111	5.556	5.556	5.556
m ² - kg	23.144	23.144	23.667	23.222	23.224	23.224	23.224
Bundle - pieces	11	11	15	11	6	6	6
Bundle - m ²	0.990	0.990	0.900	0.990	1.080	1.080	1.080
Bundle - kg	22.913	22.913	21.300	22.990	25.080	25.080	25.080
Pallet - m ²	47.520	47.520	36.000	39.600	43.197	43.197	43.197
Pallet - kg	1,099.824	1,099.824	852.012	919.600	1,003.200	1,003.200	1,003.200
Product standard	Bla	Bla	Bla	Bla	Bla	Bla	Bla
Slip resistance	R10/A	R11/B	R10/A	R10/A	R10/A	R11/B	R12/C
Stress group	3	3	2	2	2	2	2
	430292H	430304H	<i>430316H</i>	<i>430328H</i>	430340H	430352H	430364H
anthracite	Price gr. A109 (m ²)	Price gr. A109 (m ²)	Price gr. <i>A199</i> (m ²)	Price gr. <i>A199</i> (m ²)	Price gr. A121 (m ²)	Price gr. A121 (m ²)	Price gr. A154 (m ²)
	430293H	430305H	<i>430317H</i>	<i>430329H</i>	430341H	430353H	430365H
basalt	Price gr. A109 (m ²)	Price gr. A109 (m ²)	Price gr. <i>A199</i> (m ²)	Price gr. <i>A199</i> (m ²)	Price gr. A121 (m ²)	Price gr. A121 (m ²)	Price gr. A154 (m ²)
	430294H	430306H	<i>430318H</i>	<i>430330H</i>	430342H	430354H	430366H
pebble	Price gr. A109 (m ²)	Price gr. A109 (m ²)	Price gr. <i>A199</i> (m ²)	Price gr. <i>A199</i> (m ²)	Price gr. A121 (m ²)	Price gr. A121 (m ²)	Price gr. A154 (m ²)
	430295H	430307H	<i>430319H</i>	<i>430331H</i>	430343H	430355H	430367H
stone	Price gr. A109 (m ²)	Price gr. A109 (m ²)	Price gr. <i>A199</i> (m ²)	Price gr. <i>A199</i> (m ²)	Price gr. A121 (m ²)	Price gr. A121 (m ²)	Price gr. A154 (m ²)
	430296H	430308H	<i>430320H</i>	<i>430332H</i>	430344H	430356H	430368H
sand-white	Price gr. A109 (m ²)	Price gr. A109 (m ²)	Price gr. <i>A199</i> (m ²)	Price gr. <i>A199</i> (m ²)	Price gr. A121 (m ²)	Price gr. A121 (m ²)	Price gr. A154 (m ²)
	430297H	430309H	<i>430321H</i>	<i>430333H</i>	430345H	430357H	430369H
sand-grey	Price gr. A109 (m ²)	Price gr. A109 (m ²)	Price gr. <i>A199</i> (m ²)	Price gr. <i>A199</i> (m ²)	Price gr. A121 (m ²)	Price gr. A121 (m ²)	Price gr. A154 (m ²)
	430298H	430310H	<i>430322H</i>	<i>430334H</i>	430346H	430358H	430370H
sand	Price gr. A109 (m ²)	Price gr. A109 (m ²)	Price gr. <i>A199</i> (m ²)	Price gr. <i>A199</i> (m ²)	Price gr. A121 (m ²)	Price gr. A121 (m ²)	Price gr. A154 (m ²)
	430299H	430311H	<i>430323H</i>	<i>430335H</i>	430347H	430359H	430371H
nutmeg	Price gr. A109 (m ²)	Price gr. A109 (m ²)	Price gr. <i>A199</i> (m ²)	Price gr. <i>A199</i> (m ²)	Price gr. A121 (m ²)	Price gr. A121 (m ²)	Price gr. A154 (m ²)
	430300H	430312H	<i>430324H</i>	<i>430336H</i>	430348H	430360H	430372H
platinum	Price gr. A109 (m ²)	Price gr. A109 (m ²)	Price gr. <i>A199</i> (m ²)	Price gr. <i>A199</i> (m ²)	Price gr. A121 (m ²)	Price gr. A121 (m ²)	Price gr. A154 (m ²)
	430301H	430313H	<i>430325H</i>	<i>430337H</i>	430349H	430361H	430373H
sand-beige	Price gr. A109 (m ²)	Price gr. A109 (m ²)	Price gr. <i>A199</i> (m ²)	Price gr. <i>A199</i> (m ²)	Price gr. A121 (m ²)	Price gr. A121 (m ²)	Price gr. A154 (m ²)
	430302H	430314H	<i>430326H</i>	<i>430338H</i>	430350H	430362H	430374H
brick	Price gr. A109 (m ²)	Price gr. A109 (m ²)	Price gr. <i>A199</i> (m ²)	Price gr. <i>A199</i> (m ²)	Price gr. A121 (m ²)	Price gr. A121 (m ²)	Price gr. A154 (m ²)
	430303H	430315H	<i>430327H</i>	<i>430339H</i>	430351H	430363H	430375H
clay	Price gr. A109 (m ²)	Price gr. A109 (m ²)	Price gr. <i>A199</i> (m ²)	Price gr. <i>A199</i> (m ²)	Price gr. A121 (m ²)	Price gr. A121 (m ²)	Price gr. A154 (m ²)

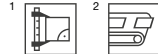

Floor Tiles

60 x 60 cm¹

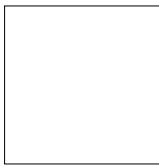

60 x 60 cm^{2/3/5}



60 x 60 cm¹



60 x 60 cm¹

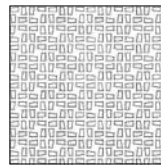

60 x 120 cm^{1/4/6}

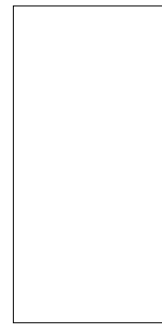

60 x 120 cm^{1/4/6}

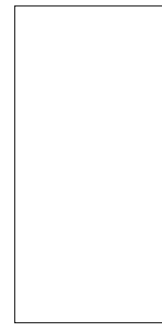

	<i>extra thick</i>		<i>Grid</i>				
	60 x 60 / 24 x 24	60 x 60 / 24 x 24	60 x 60 / 24 x 24	60 x 60 / 24 x 24	60 x 120 / 24 x 48	60 x 120 / 24 x 48	Nom. dim. - cm/in
	597 x 597 x 10.5 mm	600 x 600 x 14 mm	597 x 597 x 10.5 mm	597 x 597 x 10.5 mm	597 x 1197 x 10.5 mm	597 x 1197 x 10.5 mm	Work size
	smooth, matt	smooth, matt	smooth, matt	profiled, matt	smooth, matt	smooth, matt	Surface
	2.778	2.778	2.778	2.778	1.389	1.389	m ² - pieces
	23.769	31.669	23.769	23.769	24.672	24.672	m ² - kg
	3	2	3	3	2	2	Bundle - pieces
	1.080	0.720	1.080	1.080	1.440	1.440	Bundle - m ²
	25.668	22.800	25.668	25.668	35.526	35.526	Bundle - kg
	38.880	30.238	38.880	38.880	43.197	43.197	Bundle - m ²
	924.048	957.600	924.048	924.048	1,065.780	1,065.780	Pallet - kg
	Bla	Bla	Bla	Bla	Bla	Bla	Product standard
	R10/A	R10	R11/B	R12V4	R10/A	R11/B	Slip resistance
	3	4	3	3	2	2	Stress group
	430380H		430214H	430392H	430398H	430410H	anthracite <input type="checkbox"/> V2
	Price gr. A136 (m ²)		Price gr. A136 (m ²)	Price gr. A166 (m ²)	Price gr. A154 (m ²)	Price gr. A154 (m ²)	
	430381H		430215H	430393H	430399H	430411H	basalt <input type="checkbox"/> V2
	Price gr. A136 (m ²)		Price gr. A136 (m ²)	Price gr. A166 (m ²)	Price gr. A154 (m ²)	Price gr. A154 (m ²)	
	430382H	430200H	430216H	430394H	430400H	430412H	pebble <input type="checkbox"/> V2
	Price gr. A136 (m ²)		Price gr. A136 (m ²)	Price gr. A166 (m ²)	Price gr. A154 (m ²)	Price gr. A154 (m ²)	
	430383H				430401H	430413H	stone <input type="checkbox"/> V2
	Price gr. A136 (m ²)				Price gr. A154 (m ²)	Price gr. A154 (m ²)	
	430384H	430201H			430402H	430414H	sand-white <input type="checkbox"/> V2
	Price gr. A136 (m ²)				Price gr. A154 (m ²)	Price gr. A154 (m ²)	
	430385H	430202H	430217H	430395H	430403H	430415H	sand-grey <input type="checkbox"/> V2
	Price gr. A136 (m ²)		Price gr. A136 (m ²)	Price gr. A166 (m ²)	Price gr. A154 (m ²)	Price gr. A154 (m ²)	
	430386H		430218H	430396H	430404H	430416H	sand <input type="checkbox"/> V2
	Price gr. A136 (m ²)		Price gr. A136 (m ²)	Price gr. A166 (m ²)	Price gr. A154 (m ²)	Price gr. A154 (m ²)	
	430387H				430405H	430417H	nutmeg <input type="checkbox"/> V2
	Price gr. A136 (m ²)				Price gr. A154 (m ²)	Price gr. A154 (m ²)	
	430388H		435576H NEW	435577H NEW	430406H	430418H	platinum <input type="checkbox"/> V2
	Price gr. A136 (m ²)		Price gr. A136 (m ²)	Price gr. A166 (m ²)	Price gr. A154 (m ²)	Price gr. A154 (m ²)	
	430389H		430219H	430397H	430407H	430419H	sand-beige <input type="checkbox"/> V2
	Price gr. A136 (m ²)		Price gr. A136 (m ²)	Price gr. A166 (m ²)	Price gr. A154 (m ²)	Price gr. A154 (m ²)	
	430390H				430408H	430420H	brick <input type="checkbox"/> V2
	Price gr. A136 (m ²)				Price gr. A154 (m ²)	Price gr. A154 (m ²)	
	430391H				430409H	430421H	clay <input type="checkbox"/> V2
	Price gr. A136 (m ²)				Price gr. A154 (m ²)	Price gr. A154 (m ²)	

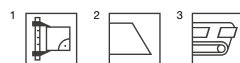

⁴ High weight only to carry with two persons.

⁵ Prices are calculated project-specifically.

⁶ Important: special pallet, no return, no exchange



Floor Tile^{1/2/3}

Cove Skirting, decorated⁴

Internal Corner

External Corner

90 x 90 cm

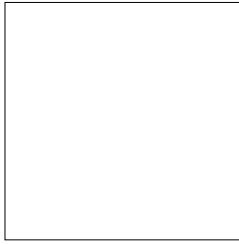

10 x 10 cm



10 x 20 cm



10 x 30 cm



10 x 60 cm



Nom. dim. - cm/in	90 x 90 / 36 x 36	10 x 10 / 4 x 4	10 x 20 / 4 x 8	10 x 30 / 4 x 12	10 x 60 / 4 x 24		
Work size	895 x 895 x 11 mm	100 x 97 x 6.5 mm	102 x 197 x 9 mm	102 x 297 x 9 mm	102 x 597 x 9 mm	102 x 20 x 9 mm	102 x 35 x 9 mm
Surface	smooth, matt	smooth, matt	smooth, matt	smooth, matt	smooth, matt	smooth, matt	smooth, matt
m ² - pieces	1.234/m ²	10.000/m	5.000/m	3.333/m	1.667/m		
m ² - kg	24.691/m ²	1.500/m	2.000/m	1.999/m	2.000/m	0.080/piece	0.080/piece
Bundle - pieces	2	40	20	16	16	18	12
Bundle - m ²	1.620 m ²	4.000 m	4.000 m	4.800 m	9.598 m		
Bundle - kg	40.018	6.000	8.000	9.600	19.200	1.440	0.960
Pallet - m ²	48.622						
Pallet - kg	1,200.540						
Product standard	Bla	Bla	Bla	Bla	Bla	Bla	Bla
Slip resistance	R10/A	R10/B	R10/A	R10/A	R10/A		
Stress group	3						
anthracite <input type="checkbox"/>	430422 Price gr. A181 (m ²)	430564H Price gr. A411 (pce.)	430428H Price gr. A419 (pce.)	430440H Price gr. A425 (pce.)	430452H Price gr. A445 (pce.)	430480H Price gr. A418 (pce.)	430492H Price gr. A418 (pce.)
basalt <input type="checkbox"/>	430423 Price gr. A181 (m ²)	430565H Price gr. A411 (pce.)	430429H Price gr. A419 (pce.)	430441H Price gr. A425 (pce.)	430453H Price gr. A445 (pce.)	430481H Price gr. A418 (pce.)	430493H Price gr. A418 (pce.)
pebble <input type="checkbox"/>	430424 Price gr. A181 (m ²)	430566H Price gr. A411 (pce.)	430430H Price gr. A419 (pce.)	430442H Price gr. A425 (pce.)	430454H Price gr. A445 (pce.)	430482H Price gr. A418 (pce.)	430494H Price gr. A418 (pce.)
stone <input type="checkbox"/>		430567H Price gr. A411 (pce.)	430431H Price gr. A419 (pce.)	430443H Price gr. A425 (pce.)	430455H Price gr. A445 (pce.)	430483H Price gr. A418 (pce.)	430495H Price gr. A418 (pce.)
sand-white <input type="checkbox"/>		430568H Price gr. A411 (pce.)	430432H Price gr. A419 (pce.)	430444H Price gr. A425 (pce.)	430456H Price gr. A445 (pce.)	430484H Price gr. A418 (pce.)	430496H Price gr. A418 (pce.)
sand-grey <input type="checkbox"/>	430425 Price gr. A181 (m ²)	430569H Price gr. A411 (pce.)	430433H Price gr. A419 (pce.)	430445H Price gr. A425 (pce.)	430457H Price gr. A445 (pce.)	430485H Price gr. A418 (pce.)	430497H Price gr. A418 (pce.)
sand <input type="checkbox"/>	430426 Price gr. A181 (m ²)	430570H Price gr. A411 (pce.)	430434H Price gr. A419 (pce.)	430446H Price gr. A425 (pce.)	430458H Price gr. A445 (pce.)	430486H Price gr. A418 (pce.)	430498H Price gr. A418 (pce.)
nutmeg <input type="checkbox"/>		430571H Price gr. A411 (pce.)	430435H Price gr. A419 (pce.)	430447H Price gr. A425 (pce.)	430459H Price gr. A445 (pce.)	430487H Price gr. A418 (pce.)	430499H Price gr. A418 (pce.)
platinum <input type="checkbox"/>		430572H Price gr. A411 (pce.)	430436H Price gr. A419 (pce.)	430448H Price gr. A425 (pce.)	430460H Price gr. A445 (pce.)	430488H Price gr. A418 (pce.)	430500H Price gr. A418 (pce.)
sand-beige <input type="checkbox"/>	430427 Price gr. A181 (m ²)	430573H Price gr. A411 (pce.)	430437H Price gr. A419 (pce.)	430449H Price gr. A425 (pce.)	430461H Price gr. A445 (pce.)	430489H Price gr. A418 (pce.)	430501H Price gr. A418 (pce.)
brick <input type="checkbox"/>		430574H Price gr. A411 (pce.)	430438H Price gr. A419 (pce.)	430450H Price gr. A425 (pce.)	430462H Price gr. A445 (pce.)	430490H Price gr. A418 (pce.)	430502H Price gr. A418 (pce.)
clay <input type="checkbox"/>		430575H Price gr. A411 (pce.)	430439H Price gr. A419 (pce.)	430451H Price gr. A425 (pce.)	430463H Price gr. A445 (pce.)	430491H Price gr. A418 (pce.)	430503H Price gr. A418 (pce.)



¹ without Hytect coating; with Protecta upgrading

² Important: special pallet, no return, no exchange

³ Color deviations compared to the adjoining covering due to production are no reason for complaint in case of horizontal laying.

For detail drawings of cove skirtings / internal corners / external corners refer to the pages 536 and the following.

Shower Tub System^{1/2}

10 x 10 cm



10 x 10 cm



				Strip	Corner		
				10 x 10 / 4 x 4	10 x 10 / 4 x 4	Nom. dim. - cm/in	
				97 x 97 x 6.5 mm	97 x 97 x 6.5 mm	Work size	
				smooth, matt	smooth, matt	Surface	
				10.000		m - pieces	
				1.700/m	0.170/pieces	m/pce. - kg	
				16	4	Bundle - pieces	
				1.600		Bundle - m	
				2.720	0.680	Bundle - kg	
				Bla	Bla	Product standard	
				R10/B	R10/B	Slip resistance	
				430064H	430070H	anthracite	V2
				Price gr. A445 (pce.)	Price gr. A475 (pce.)		
				430065H	430071H	basalt	V2
				Price gr. A445 (pce.)	Price gr. A475 (pce.)		
				430066H	430072H	pebble	V2
				Price gr. A445 (pce.)	Price gr. A475 (pce.)		
				430067H	430073H	sand-grey	V2
				Price gr. A445 (pce.)	Price gr. A475 (pce.)		
				430068H	430074H	sand	V2
				Price gr. A445 (pce.)	Price gr. A475 (pce.)		
				430069H	430075H	sand-beige	V2
				Price gr. A445 (pce.)	Price gr. A475 (pce.)		



² For details, refer to page 534

Stair Tiles with grooves²

Stair Tile with grooves 1/2/4

Stair Tile with bevel^{2/3}

Stair Tile with bevel & grooves 2/3/4

Riser^{2/3}

30 x 30 cm



30 x 60 cm¹

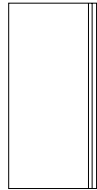

60 x 120 cm

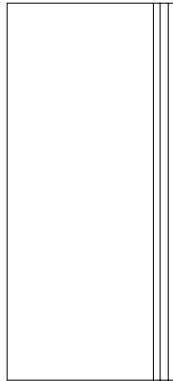

31 x 145 cm

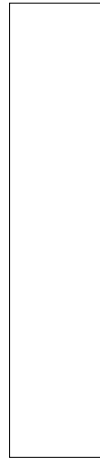

31 x 145 cm

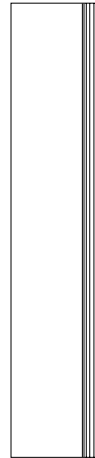

28 x 145 cm

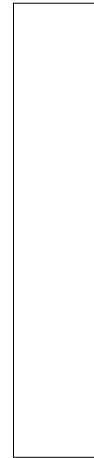

Nom. dim. - cm/in	30 x 30 / 12 x 12	30 x 60 / 12 x 24	60 x 120 / 24 x 48	31 x 145 / 12 3/8 x 58	31 x 145 / 12 3/8 x 58	28 x 145 / 11 3/16 x 58
Work size	297 x 297 x 10.5 mm	297 x 597 x 10.5 mm	597 x 1197 x 10.5 mm	307 x 1447 x 10.5 mm	307 x 1447 x 10.5 mm	280 x 1447 x 10.5 mm
Surface	smooth, matt	smooth, matt	smooth, matt	smooth, matt	smooth, matt	smooth, matt
m - pieces	3.333	1.667	0.833	0.690	0.690	0.690
m - kg	6.943	6.968	14.286	7.480	7.480	6.716
Bundle - pieces	10	6	2	2	2	2
Bundle - m	3.000	3.599	2.401	2.899	2.899	2.899
Bundle - kg	20.830	25.080	34.300	21.682	21.682	19.466
Product standard	Bla	Bla	Bla	Ala	Ala	Ala
Slip resistance	R10/A	R10/A	R10/A	R10/A	R10/A	R10/A
Stress group	3	2	2	2	2	2
anthracite	430464H Price gr. A449 (pce.)	430504H Price gr. A458 (pce.)	430398H-TF ⁵ Price gr. A593 (pce.)	435685H ⁵ Price gr. A560 (pce.)	435685H-TF ⁵ Price gr. A577 (pce.)	435695H ⁵ Price gr. A528 (pce.)
basalt	430465H Price gr. A449 (pce.)	430505H Price gr. A458 (pce.)	430399H-TF Price gr. A593 (pce.)	435686H Price gr. A560 (pce.)	435686H-TF Price gr. A577 (pce.)	435696H Price gr. A528 (pce.)
pebble	430466H Price gr. A449 (pce.)	430506H Price gr. A458 (pce.)	430400H-TF Price gr. A593 (pce.)	435687H Price gr. A560 (pce.)	435687H-TF Price gr. A577 (pce.)	435697H Price gr. A528 (pce.)
stone	430467H Price gr. A449 (pce.)	430507H Price gr. A458 (pce.)	430401H-TF Price gr. A593 (pce.)	435688H Price gr. A560 (pce.)	435688H-TF Price gr. A577 (pce.)	435698H Price gr. A528 (pce.)
sand-white	430468H Price gr. A449 (pce.)	430508H Price gr. A458 (pce.)	430402H-TF Price gr. A593 (pce.)	435689H Price gr. A560 (pce.)	435689H-TF Price gr. A577 (pce.)	435699H Price gr. A528 (pce.)
sand-grey	430469H Price gr. A449 (pce.)	430509H Price gr. A458 (pce.)	430403H-TF Price gr. A593 (pce.)	430476H Price gr. A560 (pce.)	430476H-TF Price gr. A577 (pce.)	430477H Price gr. A528 (pce.)
sand	430470H Price gr. A449 (pce.)	430510H Price gr. A458 (pce.)	430404H-TF Price gr. A593 (pce.)	435690H Price gr. A560 (pce.)	435690H-TF Price gr. A577 (pce.)	435700H Price gr. A528 (pce.)
nutmeg	430471H Price gr. A449 (pce.)	430511H Price gr. A458 (pce.)	430405H-TF Price gr. A593 (pce.)	435691H Price gr. A560 (pce.)	435691H-TF Price gr. A577 (pce.)	435701H Price gr. A528 (pce.)
platinum	430472H Price gr. A449 (pce.)	430512H Price gr. A458 (pce.)	430406H-TF Price gr. A593 (pce.)	435692H Price gr. A560 (pce.)	435692H-TF Price gr. A577 (pce.)	435702H Price gr. A528 (pce.)
sand-beige	430473H Price gr. A449 (pce.)	430513H Price gr. A458 (pce.)	430407H-TF Price gr. A593 (pce.)	435693H Price gr. A560 (pce.)	435693H-TF Price gr. A577 (pce.)	435703H Price gr. A528 (pce.)
brick	430474H Price gr. A449 (pce.)	430514H Price gr. A458 (pce.)	430408H-TF Price gr. A593 (pce.)	435694H Price gr. A560 (pce.)	435694H-TF Price gr. A577 (pce.)	435704H Price gr. A528 (pce.)
clay	430475H Price gr. A449 (pce.)	430515H Price gr. A458 (pce.)	430409H-TF ⁵ Price gr. A593 (pce.)	430212H ⁵ Price gr. A560 (pce.)	430212H-TF ⁵ Price gr. A577 (pce.)	430248H ⁵ Price gr. A528 (pce.)



³ Rectified only on the two short sides. The long side can not be rectified.

⁴ For details, refer to page 538

⁵ Due to production reasons, slight deviations may occur.

Stair Edges^{1/2/4}

Stair Edge with bevel^{2/3/4}

Skirting, rounded¹

4 x 60 cm



7,2 x 60 cm



7,2 x 120 cm



7,2 x 145 cm



7 x 30 cm



7 x 60 cm



	4 x 60 / 1 5/8 x 24	7.2 x 60 / 2 7/8 x 24	7.2 x 120 / 2 7/8 x 48	7.2 x 145 / 2 7/8 x 58	7 x 30 / 2 13/16 x 12	7 x 60 / 2 13/16 x 24	Nom. dim. - cm/in
	40 x 597 x 10.5 mm	72 x 597 x 10.5 mm	72 x 1197 x 10.5 mm	72 x 1447 x 10.5 mm	70 x 297 x 10.5 mm	70 x 597 x 10.5 mm	Work size
	smooth, matt	smooth, matt	smooth, matt	smooth, matt	smooth, matt	smooth, matt	Surface
	1.667	1.667	0.833	0.690	3.333	1.667	m - pieces
	0.967	1.355	1.170	1.737	1.583	1.584	m - kg
	9	9	10	10	22	15	Bundle - pieces
	5.399	15.003	12.005	14.493	6.600	8.998	Bundle - m
	5.220	7.317	14.050	25.180	10.450	14.250	Bundle - kg
	Bla	Bla	Bla	Ala	Bla	Bla	Product standard
	R10/A	R10/A	R10/A	R10/A			Slip resistance
	2	2	2	2			Stress group
	430516H Price gr. A458 (pce.)	430340H-TK Price gr. A458 (pce.)	430398H-TK ⁵ Price gr. A511 (pce.)	435685H-TK ⁵ Price gr. A539 (pce.)	430080H Price gr. A419 (pce.)	430528H Price gr. A438 (pce.)	anthracite <input type="checkbox"/> V2
	430517H Price gr. A458 (pce.)	430341H-TK Price gr. A458 (pce.)	430399H-TK Price gr. A511 (pce.)	435686H-TK Price gr. A539 (pce.)	430081H Price gr. A419 (pce.)	430529H Price gr. A438 (pce.)	basalt <input type="checkbox"/> V2
	430518H Price gr. A458 (pce.)	430342H-TK Price gr. A458 (pce.)	430400H-TK Price gr. A511 (pce.)	435687H-TK Price gr. A539 (pce.)	430082H Price gr. A419 (pce.)	430530H Price gr. A438 (pce.)	pebble <input type="checkbox"/> V2
	430519H Price gr. A458 (pce.)	430343H-TK Price gr. A458 (pce.)	430401H-TK Price gr. A511 (pce.)	435688H-TK Price gr. A539 (pce.)	430083H Price gr. A419 (pce.)	430531H Price gr. A438 (pce.)	stone <input type="checkbox"/> V2
	430520H Price gr. A458 (pce.)	430344H-TK Price gr. A458 (pce.)	430402H-TK Price gr. A511 (pce.)	435689H-TK Price gr. A539 (pce.)	430084H Price gr. A419 (pce.)	430532H Price gr. A438 (pce.)	sand-white <input type="checkbox"/> V2
	430521H Price gr. A458 (pce.)	430345H-TK Price gr. A458 (pce.)	430403H-TK Price gr. A511 (pce.)	430476H-TK Price gr. A539 (pce.)	430085H Price gr. A419 (pce.)	430533H Price gr. A438 (pce.)	sand-grey <input type="checkbox"/> V2
	430522H Price gr. A458 (pce.)	430346H-TK Price gr. A458 (pce.)	430404H-TK Price gr. A511 (pce.)	435690H-TK Price gr. A539 (pce.)	430086H Price gr. A419 (pce.)	430534H Price gr. A438 (pce.)	sand <input type="checkbox"/> V2
	430523H Price gr. A458 (pce.)	430347H-TK Price gr. A458 (pce.)	430405H-TK Price gr. A511 (pce.)	435691H-TK Price gr. A539 (pce.)	430087H Price gr. A419 (pce.)	430535H Price gr. A438 (pce.)	nutmeg <input type="checkbox"/> V2
	430524H Price gr. A458 (pce.)	430348H-TK Price gr. A458 (pce.)	430406H-TK Price gr. A511 (pce.)	435692H-TK Price gr. A539 (pce.)	430088H Price gr. A419 (pce.)	430536H Price gr. A438 (pce.)	platinum <input type="checkbox"/> V2
	430525H Price gr. A458 (pce.)	430349H-TK Price gr. A458 (pce.)	430407H-TK Price gr. A511 (pce.)	435693H-TK Price gr. A539 (pce.)	430089H Price gr. A419 (pce.)	430537H Price gr. A438 (pce.)	sand-beige <input type="checkbox"/> V2
	430526H Price gr. A458 (pce.)	430350H-TK Price gr. A458 (pce.)	430408H-TK Price gr. A511 (pce.)	435694H-TK Price gr. A539 (pce.)	430090H Price gr. A419 (pce.)	430538H Price gr. A438 (pce.)	brick <input type="checkbox"/> V2
	430527H Price gr. A458 (pce.)	430351H-TK Price gr. A458 (pce.)	430409H-TK ⁵ Price gr. A511 (pce.)	430212H-TK ⁵ Price gr. A539 (pce.)	430091H Price gr. A419 (pce.)	430539H Price gr. A438 (pce.)	clay <input type="checkbox"/> V2

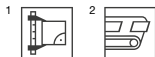

³ Rectified only on the two short sides. The long side can not be rectified.

⁴ For details, refer to page 538

⁵ Due to production reasons, slight deviations may occur.



Guide Tiles^{1/2/3}

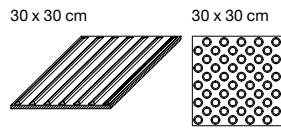

Nom. dim. - cm/in	30 x 30 / 12 x 12	30 x 30 / 12 x 12					
Work size	297 x 297 x 10.5 mm	297 x 297 x 10.5 mm					
Surface	ribbed structure	knob structure					
m - pieces	3.333	3.333					
m - kg	7.999	7.999					
Bundle - pieces	8	8					
Bundle - m	2.400	2.400					
Bundle - kg	19.200	19.200					
Product standard	Bla	Bla					
Slip resistance	R11	R11					
Stress group	3	3					
anthracite <input type="checkbox"/>	<i>430304H-R</i> <i>Price gr. A455 (pce.)</i>	<i>430304H-N</i> <i>Price gr. A539 (pce.)</i>					
platinum <input type="checkbox"/>	<i>430312H-R</i> <i>Price gr. A455 (pce.)</i>	<i>430312H-N</i> <i>Price gr. A539 (pce.)</i>					



¹ Complying with the requirements of DIN 32984
² Other color combinations on request, taking into account the luminance contrast specifications from DIN 32984

Grooved Tiles, 12.5 mm thick, for
continuing the pool edge system
"Finland II"^{1/2}

Gutter Tiles^{1/2/3}

25 x 50 cm

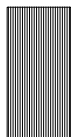

25 x 25 cm



12.5 x 25 cm



50 x 25 cm

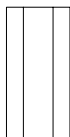

50 x 25 cm⁴

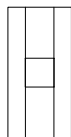

50 x 25 cm

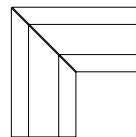

50 x 25 cm⁴

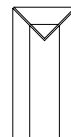

50 x 25 / 20 x 10	25 x 25 / 10 x 10	12.5 x 25 / 5 x 10	Gutter tile 50 x 25 / 20 x 10	Gutter tile with outlet 110 / 110 mm 50 x 25 / 20 x 10	Gutter tile, mitred pair 50 x 25 cm	Gutter tile, terminal piece 50 x 25 cm ⁴	
494 x 244 x 12.5 mm	244 x 244 x 12.5 mm	119 x 244 x 12.5 mm	494 x 244 x 14 mm	494 x 244 x 14 mm	(2x) 490 x 244 x 14 mm	494 x 244 x 14 mm	Nom. dim. - cm/in
grooved, matt	grooved, matt	grooved, matt	smooth, matt	smooth, matt	smooth, matt	smooth, matt	Work size
2.000	4.000	8.000	2.000	2.000	3.800/pair	2.500/piece	Surface
3.550/piece	1.775/piece	0.888/piece	2.500/piece	2.300/piece	2 pair	5 piece	m - pieces
6 piece	9 piece	21 piece	5 piece	5 piece			pce./pair - kg
3.000	2.250	2.625	2.500	2.500			Bundle - pieces/pair
21.300	15.975	18.648	12.500	11.500	7.600	12.500	Bundle - m
Ala	Ala	Ala	Ala	Ala	Ala	Ala	Bundle - kg
R11/C	R11/C	R11/C	R11/B	R11/B	R11/B	R11/B	Product standard
435601H	435613H	435625H	435637H	435649H	435661H	435673H	Slip resistance
Price gr. A560 (pce.)	Price gr. A480 (pce.)	Price gr. A430 (pce.)	Price gr. A519 (pce.)	Price gr. A593 (pce.)	Price gr. A645 (pair)	Price gr. A593 (pair)	anthracite <input type="checkbox"/> V2
435602H	435614H	435626H	435638H	435650H	435662H	435674H	basalt <input type="checkbox"/> V2
Price gr. A560 (pce.)	Price gr. A480 (pce.)	Price gr. A430 (pce.)	Price gr. A519 (pce.)	Price gr. A593 (pce.)	Price gr. A645 (pair)	Price gr. A593 (pair)	pebble <input type="checkbox"/> V2
435603H	435615H	435627H	435639H	435651H	435663H	435675H	stone <input type="checkbox"/> V2
Price gr. A560 (pce.)	Price gr. A480 (pce.)	Price gr. A430 (pce.)	Price gr. A519 (pce.)	Price gr. A593 (pce.)	Price gr. A645 (pair)	Price gr. A593 (pair)	sand-white <input type="checkbox"/> V2
435604H	435616H	435628H	435640H	435652H	435664H	435676H	sand-grey <input type="checkbox"/> V2
Price gr. A560 (pce.)	Price gr. A480 (pce.)	Price gr. A430 (pce.)	Price gr. A519 (pce.)	Price gr. A593 (pce.)	Price gr. A645 (pair)	Price gr. A593 (pair)	sand <input type="checkbox"/> V2
435605H	435617H	435629H	435641H	435653H	435665H	435677H	nutmeg <input type="checkbox"/> V2
Price gr. A560 (pce.)	Price gr. A480 (pce.)	Price gr. A430 (pce.)	Price gr. A519 (pce.)	Price gr. A593 (pce.)	Price gr. A645 (pair)	Price gr. A593 (pair)	platinum <input type="checkbox"/> V2
435606H	435618H	435630H	435642H	435654H	435666H	435678H	sand-beige <input type="checkbox"/> V2
Price gr. A560 (pce.)	Price gr. A480 (pce.)	Price gr. A430 (pce.)	Price gr. A519 (pce.)	Price gr. A593 (pce.)	Price gr. A645 (pair)	Price gr. A593 (pair)	brick <input type="checkbox"/> V2
435607H	435619H	435631H	435643H	435655H	435667H	435679H	clay <input type="checkbox"/> V2
Price gr. A560 (pce.)	Price gr. A480 (pce.)	Price gr. A430 (pce.)	Price gr. A519 (pce.)	Price gr. A593 (pce.)	Price gr. A645 (pair)	Price gr. A593 (pair)	
435608H	435620H	435632H	435644H	435656H	435668H	435680H	
Price gr. A560 (pce.)	Price gr. A480 (pce.)	Price gr. A430 (pce.)	Price gr. A519 (pce.)	Price gr. A593 (pce.)	Price gr. A645 (pair)	Price gr. A593 (pair)	
435609H	435621H	435633H	435645H	435657H	435669H	435681H	
Price gr. A560 (pce.)	Price gr. A480 (pce.)	Price gr. A430 (pce.)	Price gr. A519 (pce.)	Price gr. A593 (pce.)	Price gr. A645 (pair)	Price gr. A593 (pair)	
435610H	435622H	435634H	435646H	435658H	435670H	435682H	
Price gr. A560 (pce.)	Price gr. A480 (pce.)	Price gr. A430 (pce.)	Price gr. A519 (pce.)	Price gr. A593 (pce.)	Price gr. A645 (pair)	Price gr. A593 (pair)	
435611H	435623H	435635H	435647H	435659H	435671H	435683H	
Price gr. A560 (pce.)	Price gr. A480 (pce.)	Price gr. A430 (pce.)	Price gr. A519 (pce.)	Price gr. A593 (pce.)	Price gr. A645 (pair)	Price gr. A593 (pair)	
435612H	435624H	435636H	435648H	435660H	435672H	435684H	
Price gr. A560 (pce.)	Price gr. A480 (pce.)	Price gr. A430 (pce.)	Price gr. A519 (pce.)	Price gr. A593 (pce.)	Price gr. A645 (pair)	Price gr. A593 (pair)	



² Short edge rectified

³ On request, also available in a length of 497 mm.

⁴ Minimum order quantity: 10 pieces. In case of smaller quantities, the price must be individually calculated.

Further details about the pool edge system Finland II / Gutter Tiles are to be found in the Pool + Spa programme of delivery.

Patio Tiles^{1/2}

60 x 60 cm

60 x 60 cm

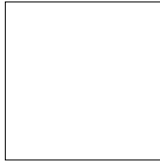

Surface decor "Square"

Nom. dim. - cm/in	60 x 60 / 24 x 24	60 x 60 / 24 x 24					
Work size	597 x 597 x 20 mm	597 x 597 x 20 mm					
Surface	smooth, matt	smooth, matt					
m ² - pieces	2,778	2,778					
m ² - kg	45.273	45.273					
Bundle - pieces	2	2					
Bundle - m ²	0.720	0.720					
Bundle - kg	32.594	32.594					
Pallet - m ²	21.598	21.598					
Pallet - kg	977.820	977.820					
Product standard	Bla	Bla					
Slip resistance	R11/B	R11/B					
Stress group	4	4					
anthracite <input type="checkbox"/> V2	430093H Price gr. A199 (m ²)						
basalt <input type="checkbox"/> V2	430094H Price gr. A199 (m ²)						
basalt <input type="checkbox"/> V3		430115H Price gr. A199 (m ²)					
pebble <input type="checkbox"/> V2	430095H Price gr. A199 (m ²)						
sand-grey <input type="checkbox"/> V2	430096H Price gr. A199 (m ²)						
sand-grey <input type="checkbox"/> V3		430116H Price gr. A199 (m ²)					
sand <input type="checkbox"/> V2	430097H Price gr. A199 (m ²)						
sand-beige <input type="checkbox"/> V2	430098H Price gr. A199 (m ²)						
sand-beige <input type="checkbox"/> V3		430117H Price gr. A199 (m ²)					



² High weight only to carry with two persons.

Special Pieces – Patio Tiles¹

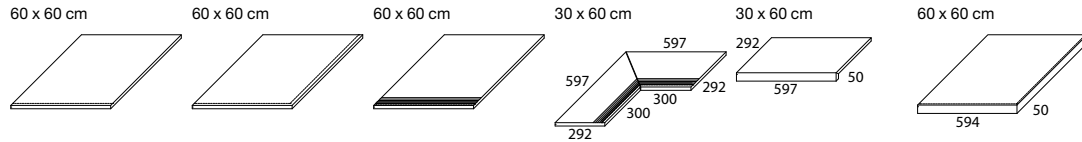

<i>Patio tile with rounded edge on one side</i>	<i>Patio tile with corneradjacent rounded edges</i>	<i>Patio tile with rounded edge on one side and grooves</i>	<i>Patio tile with rounded edge on one side and grooves as corner solution (2 pieces)</i>	<i>Patio tile step with nosing</i>	<i>Patio tile step with nosing as corner solution</i>	
60 x 60 / 24 x 24	60 x 60 / 24 x 24	60 x 60 / 24 x 24	30 x 60 / 12 x 24	30 x 60 / 12 x 24	60 x 60 / 24 x 24	Nom. dim. - cm/in
597 x 597 x 20 mm	597 x 597 x 20 mm	597 x 597 x 20 mm	292 x 597 x 20 mm	292/50 x 597 x 20 mm	594/50 x 594 x 20 mm	Work size
smooth, matt	smooth, matt	smooth, matt	smooth, matt	smooth, matt	smooth, matt	Surface
1.667	1.667	1.667	1.667	1.667		m - pieces
27.167/m	27.167/m	27.167/m	16.297/pair	15.868/m		m/pair - kg
1 piece	1 piece	1 piece	1 pair	1 piece	1 piece	Bundle - pieces/pair
0.600	0.600	0.600				Bundle - m
16.297	16.297	16.297	16.297	9.519	19.027	Bundle - kg
						Pallet - m
Bla	Bla	Bla	Bla	Bla	Bla	Pallet - kg
R11/B	R11/B	R11/B	R11/B	R11/B	R11/B	Product standard
4	4	4	4	4	4	Slip resistance
430093H-RE	430093H-RZ	430093H-RER	430093H-RERZ	430093H-SE	430093H-SZ	Stress group
<i>Price gr. A672 (pce.)</i>	<i>Price gr. A731 (pce.)</i>	<i>Price gr. A689 (pce.)</i>	<i>Price gr. A792 (pce.)</i>	<i>Price gr. A689 (pce.)</i>	<i>Price gr. A784 (pce.)</i>	anthracite V2



Other versions regarding edge formation and/or formats possible on request.

Minimum order quantity: 10 linear metres per order (division into several articles possible), smaller quantities after separate price calculation.







Play with movement and transparency

The Aruba series is puristic, harmonious and ideal for private bathrooms. In warm white colors and sandy shades, it is available as a wall tile and a Kentia decorative tile with palm leaf motifs. The decorative tiles can be arranged as freely and can be installed in any direction. They are available in oblong format. This, along with their unique tile pattern, offers unlimited visual freedom during installation. It also makes the filigree rhythm of the tile pattern possible and particularly emphasizes the movement of the leaves. The floor tiles complete the range, also in the particularly representative size of 60 x 120 cm and in the visually appealing mosaic format. The Hytect surface makes the entire series easy to clean, offering antibacterial protection and ensuring hygienic cleanliness.

Rendering

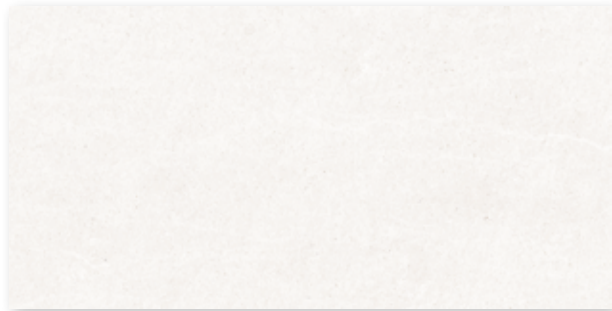

Wall tile 30 x 60 cm, 12 x 24 in, white, smooth

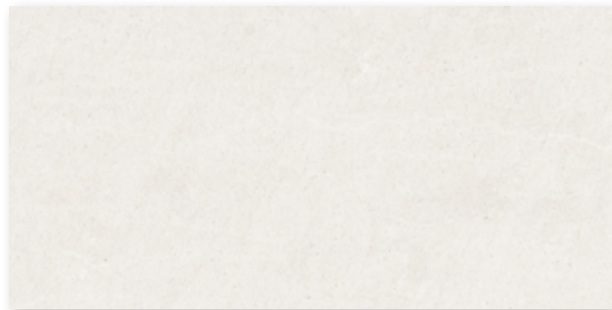

Wall tile 30 x 60 cm, 12 x 24 in, sand, smooth



Wall tile 30 x 90 cm, 12 x 36 in, white, smooth

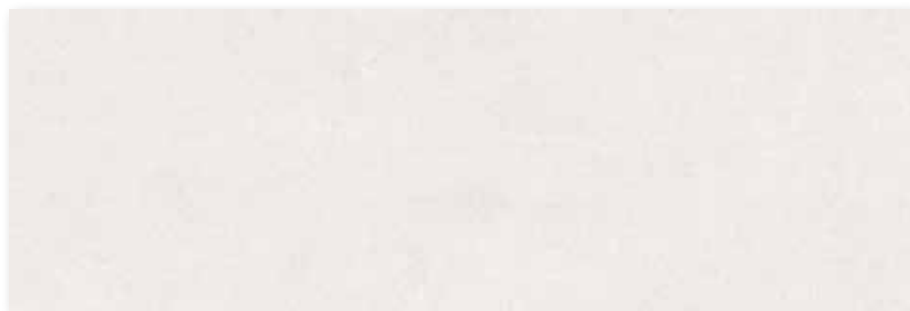

Wall tile 30 x 90 cm, 12 x 36 in, sand, smooth

Decoration Elements



Decorative tile Kentia 30 x 60 cm, 12 x 24 in, sand white, smooth



Decorative tile Kentia 30 x 90 cm, 12 x 36 in, sand white, smooth



Oblong format Kentia 7.5 x 25 cm, 3 x 20 in,
sand white, smooth



pearl



mud



stone



graphite



Floor tile 30 x 60 cm, 12 x 24 in, structured, R9



Floor tile 60 x 60 cm, 24 x 24 in, structured, R9



Floor tile 60 x 120 cm, 24 x 48 in, structured, R9



Stair tile 30 x 60 cm (with grooves), 12 x 24 in, structured, R9



Skirting, rounded 7 x 60 cm, 2 13/16 x 24 in, structured

Wall Tiles

Decoration Elements²

30 x 60 cm



30 x 90 cm¹

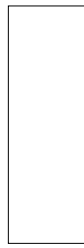

30 x 60 cm



30 x 90 cm¹



7,5 x 25 cm



	<i>Decorative tile Kentia</i>		<i>Decorative tile Kentia</i>		<i>Oblong format Kentia</i>	
Nom. dim - cm/in	30 x 60 / 12 x 24	30 x 90 / 12 x 36	30 x 60 / 12 x 24	30 x 90 / 12 x 36	7.5 x 25 / 3 1/8 x 10	
Work size	297 x 597 x 6 mm	297 x 897 x 6 mm	297 x 597 x 6 mm	297 x 897 x 6 mm	72 x 247 x 6 mm	
Surface	smooth, silky-matt	smooth, silky-matt	smooth, silky-matt	smooth, silky-matt	smooth, silky-matt	
m ² - pieces	5.556	3.704	5.556	3.704	53.333	
m ² - kg	10.279	10.400	10.279	10.400	9.813	
Bundle - pieces	13	8	13	8	18	
Bundle - m ²	2.340	2.160	2.340	2.160	0.338	
Bundle - kg	24.050	22.464	24.050	22.464	3.123	
Pallet - m ²	112.311	51.836	112.311	51.836	56.700	
Pallet - kg	1,154.400	539.136	1,154.400	539.136	556.416	
Product standard	BIII	BIII	BIII	BIII	BIII	
white	203225H Price gr. C68 (m ²)	323227H Price gr. C134 (m ²)				
sand	203226H Price gr. C68 (m ²)	323228H Price gr. C134 (m ²)				
sand white			203229H Price gr. C77 (m ²)	323230H Price gr. C143 (m ²)	203333H Price gr. C218 (m ²)	



² Decoration elements only available in full boxes.

Floor Tiles¹

Stair
Tile^{1/2}

Skirting,
rounded¹

30 x 60 cm



60 x 60 cm

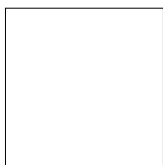

60 x 120 cm



30 x 60 cm



7 x 60 cm¹



	30 x 60 / 12 x 24	60 x 60 / 24 x 24	60 x 120 / 24 x 48	30 x 60 / 12 x 24	7 x 60 / 2 13/16 x 24	Nom. dim - cm/in
	297 x 597 x 8 mm	597 x 597 x 8 mm	597 x 1197 x 8 mm	297 x 597 x 8 mm	70 x 597 x 8 mm	Work size
	structured, matt	structured, matt	structured, matt	structured, matt	structured, matt	Surface
	5.556/m ²	2.778/m ²	1.388/m ²	1.667/m	1.667/m	m ² - pieces
	17.413/m ²	18.001/m ²	17.489/m ²	5.224/m	1.219/m	m ² - kg
	6	4	2	6	15	Bundle - pieces
	1.080/m ²	1.440/m ²	1.441/m ²	3.599/m	8.998/m	Bundle - m ²
	18.804	25.920	25.200	18.804	10.969	Bundle - kg
	43.197	43.197	36.023			Pallet - m ²
	752.160	777.600	630.000			Pallet - kg
	Alb	Alb	Alb	Alb	Alb	Product standard
	R9	R9	R9	R9		Slip resistance
	2	2	2	2		Stress group
	430834H	430838H	430842H	430846H	430850H	
	Price gr. C122 (m ²)	Price gr. C137 (m ²)	Price gr. C161 (m ²)	Price gr. C466 (pce.)	Price gr. C440 (pce.)	pearl <input type="checkbox"/> V3
	430835H	430839H	430843H	430847H	430851H	
	Price gr. C122 (m ²)	Price gr. C137 (m ²)	Price gr. C161 (m ²)	Price gr. C466 (pce.)	Price gr. C440 (pce.)	mud <input type="checkbox"/> V3
	430836H	430840H	430844H	430848H	430797H	
	Price gr. C122 (m ²)	Price gr. C137 (m ²)	Price gr. C161 (m ²)	Price gr. C466 (pce.)	Price gr. C440 (pce.)	stone <input type="checkbox"/> V3
	430837H	430841H	430845H	430849H	430798H	
	Price gr. C122 (m ²)	Price gr. C137 (m ²)	Price gr. C161 (m ²)	Price gr. C466 (pce.)	Price gr. C440 (pce.)	graphite <input type="checkbox"/> V3

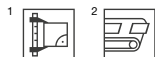





Experience diversity

Ascona is made for spas, wellness areas and swimming pools in hotels, but also for private homes. This stems from the versatility of the series. Visually, the series offers mosaics and oblong formats, small and large sizes for walls and floors, and a refined selection of colors, providing a wide range of design possibilities. The series also stands out for its functional versatility and technical solutions, making it ideal for all swimming pool areas or spas—both indoors and outdoors, in entrance areas, and spaces where visitors walk barefoot or in dedicated wet areas. With its clean lines and grounded colors, a wide variety of style worlds can be created. The series accommodates both minimalist architecture and classic or modern country house designs. The Ascona series can be perfectly combined with our mosaic series Marble & More.

Rendering



R10/A R10/B R11/B R11/C



pearl



mud



stone

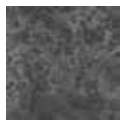

graphite



shell

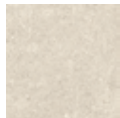

sand



Floor tile 15 x 15 cm, 6 x 6 in, structured, R10/B



Floor tile 25 x 50 cm, 10 x 20 in, structured, R11/B



Floor tile 30 x 60 cm, 12 x 24 in, structured, R10/A
Floor tile 30 x 60 cm, 12 x 24 in, structured, R11/B



Grid profile tile 25 x 50 cm, 10 x 20 in, relief, R11/C



Letter tile 25 x 50 cm, 10 x 20 in, structured, R11/B

Mosaic 5 x 5 cm, 2 x 2 in



Mosaic sheet 30 x 30 cm, 12 x 12 in, pearl, structured, R10/B



Mosaic sheet 30 x 30 cm, 12 x 12 in, mud, structured, R10/B



Mosaic sheet 30 x 30 cm, 12 x 12 in, stone, structured, R10/B



Mosaic sheet 30 x 30 cm, 12 x 12 in, graphite, structured, R10/B



Mosaic sheet 30 x 30 cm, 12 x 12 in, shell, structured, R10/B



Mosaic sheet 30 x 30 cm, 12 x 12 in, sand, structured, R10/B



Mosaics glued thermoplastically on back of Agrob Buchtal can be used not only in dry zones but also without any problems in underwater areas (e.g. swimming pools/whirlpools) as well as in permanently wet areas (e.g. pool surrounds/showers).



Floor tile 60 x 60 cm, 24 x 24 in, structured, R10/A
Floor tile 60 x 60 cm, 24 x 24 in, structured, R11/B



Cove skirting 10 x 50 cm, 4 x 20 in, structured, R10/A



Cove skirting 10 x 60 cm, 4 x 24 in, structured, R10/A



Skirting, cut, 6 x 50 cm, 2 3/8 x 20 in



Skirting, cut, 6 x 60 cm, 2 3/8 x 24 in



Stair tile with bevel and grooves, 31 x 145 cm, 12.4 x 58 in, structured, R10/A



Stair tile with bevel 31 x 145 cm, 12.4 x 58 in, structured, R10/A



Riser 28 x 145 cm, 11.2 x 58 in, structured, R10/A

Grid profile



pearl



mud



stone

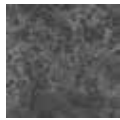

graphite



shell



sand



Floor tile 12.5 x 12.5 cm, 5 x 5 in, structured, R11/B



Floor tile 12.5 x 25 cm, 5 x 10 in, structured, R11/B



Floor tile 25 x 25 cm, 10 x 10 in, structured, R11/B



Floor tile 25 x 50 cm, 10 x 20 in, structured, R11/B

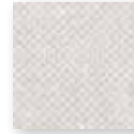

Grid profile tile 12.5 x 12.5 cm, 5 x 5 in, relief, R11/C

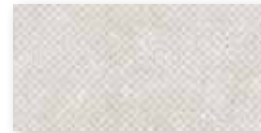

Grid profile tile 12.5 x 25 cm, 5 x 10 in, relief, R11/C



Grid profile tile 25 x 25 cm, 10 x 10 in, relief, R11/C



Grid profile tile 25 x 50 cm, 10 x 20 in, relief, R11/C



Wall tile 12.5 x 25 cm, 5 x 10 in, structured



Wall tile 25 x 50 cm, 10 x 20 in, structured



Grooved tile 12.5 x 25 cm,
5 x 10 in, grooved, R11/C



Grooved tile 25 x 25 cm,
10 x 10 in, grooved, R11/C



Grooved tile 50 x 25 cm, 10 x 20 in,
grooved, R11/C



Cove skirting 10 x 25 cm, 4 x 10 in, structured, R10/A

Gutter tile (trough depth 5 mm)



Gutter tile, 50 x 25 cm, 20 x 10 in,
structured, R11/B



Gutter tile, mitred pair
structured, R11/B



Gutter tile with outlet
structured, R11/B



Terminal piece
structured, R11/B

For details concerning gutter tiles, refer to the Pool + Spa programme of delivery.



pearl



mud



stone

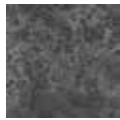

graphite



sand



Patio tile 50 x 100 cm, 20 x 40 in, structured, R11/B

Floor Tiles – joint 3 mm

Mosaic¹

5 x 5 cm



Floor Tiles

15 x 15 cm



25 x 50 cm²



25 x 50 cm^{2/3}



30 x 60 cm²

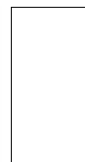

30 x 60 cm²



Sheet: 297 x 297 mm

Grid profile tile

	5 x 5 / 2 x 2	15 x 15 / 6 x 6	25 x 50 / 10 x 20	25 x 50 / 10 x 20	30 x 60 / 12 x 24	30 x 60 / 12 x 24	Nom. dim. - cm/in
	47 x 47 x 6.5 mm	147 x 147 x 8 mm	247 x 497 x 8 mm	247 x 497 x 8 mm	297 x 597 x 8 mm	297 x 597 x 8 mm	Work size
	structured, matt	structured, matt	structured, matt	relief, matt	structured, matt	structured, matt	Surface
	11 sheets	44.444	8.000	8.000	5.556	5.556	m ² - pieces
	12.331	17.555	17.040	17.040	17.413	17.413	m ² - kg
	11	35	9	9	6	6	Bundle - pieces
	1.000	0.788	1.125	1.125	1.080	1.080	Bundle - m ²
	12.331	13.825	19.170	19.170	18.804	18.804	Bundle - kg
	64.000	63.001	40.500	40.500	43.197	43.197	Pallet - m ²
	789.184	1,106.000	690.120	690.120	752.160	752.160	Pallet - kg
	Bla	Bla	Ala	Ala	Ala	Ala	Product standard
	R10/B	R10/B	R11/B	R11/C	R10/A	R11/B	Slip resistance
	1	2	2	2	2	2	Stress group
	430701H	430705H	430709H	<i>430713H</i>	430721H	430725H	
	Price gr. A226 (m ²)	Price gr. A154 (m ²)	Price gr. A166 (m ²)	Price gr. A187 (m ²)	Price gr. A124 (m ²)	Price gr. A142 (m ²)	pearl <input type="checkbox"/> V3
	430702H	430706H	430710H	<i>430714H</i>	430722H	430726H	mud <input type="checkbox"/> V3
	Price gr. A226 (m ²)	Price gr. A154 (m ²)	Price gr. A166 (m ²)	Price gr. A187 (m ²)	Price gr. A124 (m ²)	Price gr. A142 (m ²)	stone <input type="checkbox"/> V3
	430703H	430707H	430711H	<i>430715H</i>	430723H	430727H	
	Price gr. A226 (m ²)	Price gr. A154 (m ²)	Price gr. A166 (m ²)	Price gr. A187 (m ²)	Price gr. A124 (m ²)	Price gr. A142 (m ²)	graphite <input type="checkbox"/> V3
	430704H	430708H	430712H	<i>430716H</i>	430724H	430728H	
	Price gr. A226 (m ²)	Price gr. A154 (m ²)	Price gr. A166 (m ²)	Price gr. A187 (m ²)	Price gr. A124 (m ²)	Price gr. A142 (m ²)	shell <input type="checkbox"/> V3
	431501H	431503H	431505H	<i>431507H</i>	431509H	431511H	
	Price gr. A226 (m ²)	Price gr. A154 (m ²)	Price gr. A166 (m ²)	Price gr. A187 (m ²)	Price gr. A124 (m ²)	Price gr. A142 (m ²)	shell <input type="checkbox"/> V3
	431502H	431504H	431506H	<i>431508H</i>	431510H	431512H	
	Price gr. A226 (m ²)	Price gr. A154 (m ²)	Price gr. A166 (m ²)	Price gr. A187 (m ²)	Price gr. A124 (m ²)	Price gr. A142 (m ²)	sand <input type="checkbox"/> V3



Floor Tiles – joint 3 mm

Floor Tiles¹

Stair Tile with bevel and grooves^{2/3/4}

Stair Tile with bevel^{2/3/4}

Riser^{2/3/4}

60 x 60 cm

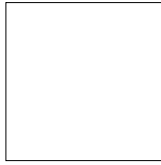

60 x 60 cm

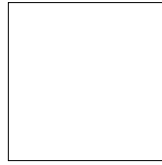

31 x 145 cm





31 x 145 cm



28 x 145 cm



Nom. dim. - cm/in	60 x 60 / 24 x 24	60 x 60 / 24 x 24	31 x 145 / 12 3/8 x 58	31 x 145 / 12 3/8 x 58	28 x 145 / 11 3/16 x 58		
Work size	597 x 597 x 8 mm	597 x 597 x 8 mm	307 x 1447 x 10.5 mm	307 x 1447 x 10.5 mm	280 x 1447 x 10.5 mm		
Surface	structured, matt	structured, matt	structured, matt	structured, matt	structured, matt		
m ² /m - pieces	2.778/m ²	2.778/m ²	0.690/m	0.690/m	0.690/m		
m ² /m - kg	18.001/m ²	18.001/m ²	7.480/m	7.480/m	6.716/m		
Bundle - pieces	4	4	2	2	2		
Bundle - m ² /m	1.440 m ²	1.440 m ²	2.899 m	2.899 m	2.899 m		
Bundle - kg	25.920	25.920	21.682	21.682	19.466		
Pallet - m ²	43.197	43.197					
Pallet - kg	777.600	777.600					
Product standard	Ala	Ala	Ala	Ala	Ala		
Slip resistance	R10/A	R11/B	R10/A	R10/A	R10/A		
Stress group	2	2	2	2	2		
pearl 	430729H Price gr. A136 (m ²)	430733H Price gr. A151 (m ²)	<i>431576H-TF</i> Price gr. <i>A577</i> (pce.)	<i>431576H</i> Price gr. <i>A560</i> (pce.)	<i>431582H</i> Price gr. <i>A528</i> (pce.)		
mud 	430730H Price gr. A136 (m ²)	430734H Price gr. A151 (m ²)	<i>431577H-TF</i> Price gr. <i>A577</i> (pce.)	<i>431577H</i> Price gr. <i>A560</i> (pce.)	<i>431583H</i> Price gr. <i>A528</i> (pce.)		
stone 	430731H Price gr. A136 (m ²)	430735H Price gr. A151 (m ²)	<i>431578H-TF</i> Price gr. <i>A577</i> (pce.)	<i>431578H</i> Price gr. <i>A560</i> (pce.)	<i>431584H</i> Price gr. <i>A528</i> (pce.)		
graphite 	430732H Price gr. A136 (m ²)	430736H Price gr. A151 (m ²)	<i>431579H-TF</i> Price gr. <i>A577</i> (pce.)	<i>431579H</i> Price gr. <i>A560</i> (pce.)	<i>431585H</i> Price gr. <i>A528</i> (pce.)		
shell 	431513H Price gr. A136 (m ²)	431515H Price gr. A151 (m ²)	<i>431580H-TF</i> Price gr. <i>A577</i> (pce.)	<i>431580H</i> Price gr. <i>A560</i> (pce.)	<i>431586H</i> Price gr. <i>A528</i> (pce.)		
sand 	431514H Price gr. A136 (m ²)	431516H Price gr. A151 (m ²)	<i>431581H-TF</i> Price gr. <i>A577</i> (pce.)	<i>431581H</i> Price gr. <i>A560</i> (pce.)	<i>431587H</i> Price gr. <i>A528</i> (pce.)		

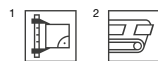

³ Rectified only on the two short sides. The long side can not be rectified.

⁴ For details, refer to page 538. For more solutions concerning stair design, refer to the series Area Pro.

Cove Skirting,
decorated^{1/2/7}

10 x 50 cm



10 x 60 cm



Skirting, cut¹

6 x 50 cm



6 x 60 cm



Letter Tile^{1/2/3}

25 x 50 cm

WT. 1.35m



Type height 7 cm

	10 x 50 / 4 x 20	10 x 60 / 4 x 24	6 x 50 / 2 3/8 x 20	6 x 60 / 2 3/8 x 24	25 x 50 / 10 x 20	
	100 x 497/35 x 9 mm	100 x 597/35 x 9 mm	60 x 497 x 8 mm	60 x 597 x 8 mm	247 x 497 x 8 mm	Nom. dim. - cm/in
	structured, matt	structured, matt	structured, matt	structured, matt	structured, matt	Work size
	2.000	1.667	2.000	1.667	2.000	Surface
	2.000/m	2.000/m	1.098/m	1.100/m	2.130/piece	m - pieces
	20	20	30	34		m/pc. - kg
	10.000	11.998	15.000	20.396		Bundle - pieces
	20.000	24.000	16.470	22.440		Bundle - m
						Bundle - kg
						Pallet - m ²
						Pallet - kg
	Alb	Alb	Ala	Ala	Ala	Product standard
	R10/A	R10/A			R11/B	Slip resistance
					2	Stress group
	430741H ⁶	430737H ⁶	430984H	430988H	430717H	pearl <input type="checkbox"/> V3
	Price gr. A441 (pce.)	Price gr. A445 (pce.)	Price gr. A434 (pce.)	Price gr. A434 (pce.)	Price gr. A668 (pce.)	
	430742H ⁵	430738H ⁵	430985H	430989H	430718H	mud <input type="checkbox"/> V3
	Price gr. A441 (pce.)	Price gr. A445 (pce.)	Price gr. A434 (pce.)	Price gr. A434 (pce.)	Price gr. A668 (pce.)	
	430743H ⁶	430739H ⁶	430986H	430990H	430719H	stone <input type="checkbox"/> V3
	Price gr. A441 (pce.)	Price gr. A445 (pce.)	Price gr. A434 (pce.)	Price gr. A434 (pce.)	Price gr. A668 (pce.)	
	430744H ⁴	430740H ⁴	430987H	430991H	430720H	graphite <input type="checkbox"/> V3
	Price gr. A441 (pce.)	Price gr. A445 (pce.)	Price gr. A434 (pce.)	Price gr. A434 (pce.)	Price gr. A668 (pce.)	
	431523H ⁶	431525H ⁶	431527H	431529H	431531H	shell <input type="checkbox"/> V3
	Price gr. A441 (pce.)	Price gr. A445 (pce.)	Price gr. A434 (pce.)	Price gr. A434 (pce.)	Price gr. A668 (pce.)	
	431524H ⁶	431526H ⁶	431528H	431530H	431532H	sand <input type="checkbox"/> V3
	Price gr. A441 (pce.)	Price gr. A445 (pce.)	Price gr. A434 (pce.)	Price gr. A434 (pce.)	Price gr. A668 (pce.)	

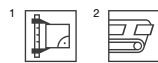

³ Only figures/letters in color 91 are available (neutral 10 / active white).

⁴ Stress group: 2

⁵ Stress group: 3

⁶ Stress group: 4

⁷ Color deviations compared to the adjoining covering due to production are no reason for complaint in case of horizontal laying.



Wall and Floor Tiles – joint 6 mm

Wall Tile

Floor Tiles

12.5 x 25 cm



12.5 x 12.5 cm²



12.5 x 12.5 cm^{1/2}



12.5 x 25 cm



12.5 x 25 cm¹



25 x 25 cm



25 x 25 cm¹



Grid profile tile

Grid profile tile

Grid profile tile

Nom. dim. - cm/in	12.5 x 25 / 5 x 10	12.5 x 12.5 / 5 x 5	12.5 x 12.5 / 5 x 5	12.5 x 25 / 5 x 10	12.5 x 25 / 5 x 10	25 x 25 / 10 x 10	25 x 25 / 10 x 10
Work size	119 x 244 x 8 mm	119 x 119 x 8 mm	119 x 119 x 8 mm	119 x 244 x 8 mm	119 x 244 x 8 mm	244 x 244 x 8 mm	244 x 244 x 8 mm
Surface	structured, matt	structured, matt	relief, matt	structured, matt	relief, matt	structured, matt	relief, matt
m ² - pieces	32.000	64.000	64.000	32.000	32.000	16.000	16.000
m ² - kg	15.680	15.360	15.360	15.680	15.680	16.960	16.960
Bundle - pieces	33	66	66	33	33	14	14
Bundle - m ²	1.031	1.031	1.031	1.031	1.031	0.875	0.875
Bundle - kg	16.170	15.840	15.840	16.170	16.170	14.840	14.840
Pallet - m ²	86.625	86.625	86.625	86.625	86.625	70.875	70.875
Pallet - kg	1,358.280	1,330.560	1,330.560	1,358.280	1,358.280	1,202.040	1,202.040
Product standard	Ala	Ala	Ala	Ala	Ala	Ala	Ala
Slip resistance	-	R11/B	R11/C	R11/B	R11/C	R11/B	R11/C
Stress group	2	2	2	2	2	2	2
pearl	430761H Price gr. A127 (m ²)	430753H Price gr. A166 (m ²)	<i>430757H</i> <i>Price gr. A166 (m²)</i>	430763H Price gr. A136 (m ²)	<i>430767H</i> <i>Price gr. A148 (m²)</i>	430771H Price gr. A175 (m ²)	<i>430775H</i> <i>Price gr. A142 (m²)</i>
mud		430754H Price gr. A166 (m ²)	<i>430758H</i> <i>Price gr. A166 (m²)</i>	430764H Price gr. A136 (m ²)	<i>430768H</i> <i>Price gr. A148 (m²)</i>	430772H Price gr. A175 (m ²)	<i>430776H</i> <i>Price gr. A142 (m²)</i>
stone		430755H Price gr. A166 (m ²)	<i>430759H</i> <i>Price gr. A166 (m²)</i>	430765H Price gr. A136 (m ²)	<i>430769H</i> <i>Price gr. A148 (m²)</i>	430773H Price gr. A175 (m ²)	<i>430777H</i> <i>Price gr. A142 (m²)</i>
graphite	430762H Price gr. A127 (m ²)	430756H Price gr. A166 (m ²)	<i>430760H</i> <i>Price gr. A166 (m²)</i>	430766H Price gr. A136 (m ²)	<i>430770H</i> <i>Price gr. A148 (m²)</i>	430774H Price gr. A175 (m ²)	<i>430778H</i> <i>Price gr. A142 (m²)</i>
shell	431533H Price gr. A127 (m ²)	431534H Price gr. A166 (m ²)	<i>431536H</i> <i>Price gr. A166 (m²)</i>	431538H Price gr. A136 (m ²)	<i>431540H</i> <i>Price gr. A148 (m²)</i>	431542H Price gr. A175 (m ²)	<i>431544H</i> <i>Price gr. A142 (m²)</i>
sand		431535H Price gr. A166 (m ²)	<i>431537H</i> <i>Price gr. A166 (m²)</i>	431539H Price gr. A136 (m ²)	<i>431541H</i> <i>Price gr. A148 (m²)</i>	431543H Price gr. A175 (m ²)	<i>431545H</i> <i>Price gr. A142 (m²)</i>



² Supplied as double-tiles; to be broken by customer.

Wall Tile²

Floor Tiles²

Grooved Tiles 12.5 mm thick,
for continuing the pool edge system
„Finland II“^{1/3/4}

25 x 50 cm



25 x 50 cm



25 x 50 cm¹



50 x 25 cm

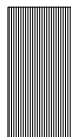

25 x 25 cm



12.5 x 25 cm



Grid profile tile

25 x 50 / 10 x 20	25 x 50 / 10 x 20	25 x 50 / 10 x 20	50 x 25 / 20 x 10	25 x 25 / 10 x 10	12.5 x 25 / 5 x 10	Nom. dim. - cm/in
244 x 494 x 8 mm	244 x 494 x 8 mm	244 x 494 x 8 mm	494 x 244 x 12.5 mm	244 x 244 x 12.5 mm	119 x 244 x 12.5 mm	Work size - mm
structured, matt	structured, matt	relief, matt	grooved, matt	grooved, matt	grooved, matt	Surface
8.000/m ²	8.000/m ²	8.000/m ²	2.000/m	4.000/m	8.000/m	m ² /m - pieces
17.040/m ²	17.040/m ²	17.040/m ²	3.550/piece	1.775/piece	0.888/piece	m ² /pce. - kg
9	9	9	6	9	21	Bundle - pieces
1.125/m ²	1.125/m ²	1.125/m ²	3.000/m	2.250/m	2.625/m	Bundle - m ² / m
19.170	19.170	19.170	21.300	15.975	18.648	Bundle - kg
40.500	40.500	40.500				Pallet - m ²
690.120	690.120	690.120				Pallet - kg
Ala	Ala	Ala	Ala	Ala	Ala	Product standard
-	R11/B	R11/C	R11/C	R11/C	R11/C	Slip resistance
	2	2				Stress group
430779H	430781H	430785H	430789H	430793H	430802H	pearl <input type="checkbox"/>
Price gr. A154 (m ²)	Price gr. A166 (m ²)	Price gr. A187 (m ²)	Price gr. A560 (pce.)	Price gr. A480 (pce.)	Price gr. A430 (pce.)	<input type="checkbox"/>
	430782H	430786H	430790H	430794H	430803H	mud <input type="checkbox"/>
	Price gr. A166 (m ²)	Price gr. A187 (m ²)	Price gr. A560 (pce.)	Price gr. A480 (pce.)	Price gr. A430 (pce.)	<input type="checkbox"/>
	430783H	430787H	430791H	430795H	430804H	stone <input type="checkbox"/>
	Price gr. A166 (m ²)	Price gr. A187 (m ²)	Price gr. A560 (pce.)	Price gr. A480 (pce.)	Price gr. A430 (pce.)	<input type="checkbox"/>
430780H	430784H	430788H	430792H	430796H	430805H	graphite <input type="checkbox"/>
Price gr. A154 (m ²)	Price gr. A166 (m ²)	Price gr. A187 (m ²)	Price gr. A560 (pce.)	Price gr. A480 (pce.)	Price gr. A430 (pce.)	<input type="checkbox"/>
431546H	431547H	431549H	431551H	431553H	431555H	shell <input type="checkbox"/>
Price gr. A154 (m ²)	Price gr. A166 (m ²)	Price gr. A187 (m ²)	Price gr. A560 (pce.)	Price gr. A480 (pce.)	Price gr. A430 (pce.)	<input type="checkbox"/>
	431548H	431550H	431552H	431554H	431556H	sand <input type="checkbox"/>
	Price gr. A166 (m ²)	Price gr. A187 (m ²)	Price gr. A560 (pce.)	Price gr. A480 (pce.)	Price gr. A430 (pce.)	<input type="checkbox"/>

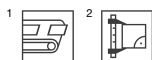

³ Short edge rectified

⁴ For more details concerning the pool edge system Finland II, refer to the Pool + Spa programme of delivery.



Cove Skirting, decorated^{1/2/10}

10 x 25 cm



Gutter Tiles^{2/3/4/6}

50 x 25 cm



50 x 25 cm⁵

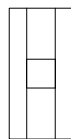

50 x 25 cm

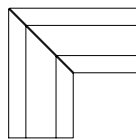

50 x 25 cm⁵

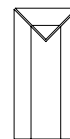

	10 x 25 / 4 x 10	Gutter Tile	50 x 25 / 20 x 10	50 x 25 / 20 x 10	Gutter tile with outlet 110 / 110 mm	Gutter tile, mitred pair	Gutter tile, terminal piece
Nom. dim. - cm/in							
Work size - mm	100 x 244/35 x 9 mm		494 x 244 x 14 mm	494 x 244 x 14 mm	494 x 244 x 14 mm	(2x) 490 x 244 x 14 mm	494 x 244 x 14 mm
Surface	structured, matt		structured, matt	structured, matt	structured, matt	structured, matt	structured, matt
m - pieces	4.000		2.000	2.000	2.000	2.000	2.000
pce./pair - kg	0.500/piece		2.500/piece	2.300/piece	2.300/piece	3.800/pair	2.500/piece
Bundle - pce./pair	20 piece		5 piece	5 piece	5 piece	2 pair	5 piece
Bundle - m			2.500	2.500	2.500		
Bundle - kg	10.000		12.500	11.500	11.500	7.600	12.500
Pallet - m ²							
Pallet - kg							
Product standard	Alb		Ala	Ala	Ala	Ala	Ala
Slip resistance	R10/A		R11/B	R11/B	R11/B	R11/B	R11/B
pearl	<input checked="" type="checkbox"/> V3 430806H ⁹ Price gr. A423 (pce.)		430810H Price gr. A519 (pce.)	430814H Price gr. A593 (pce.)	430818H Price gr. A645 (pair)	430822H Price gr. A593 (pce.)	
mud	<input checked="" type="checkbox"/> V3 430807H ⁸ Price gr. A423 (pce.)		430811H Price gr. A519 (pce.)	430815H Price gr. A593 (pce.)	430819H Price gr. A645 (pair)	430823H Price gr. A593 (pce.)	
stone	<input checked="" type="checkbox"/> V3 430808H ⁹ Price gr. A423 (pce.)		430812H Price gr. A519 (pce.)	430816H Price gr. A593 (pce.)	430820H Price gr. A645 (pair)	430824H Price gr. A593 (pce.)	
graphite	<input checked="" type="checkbox"/> V3 430809H ⁷ Price gr. A423 (pce.)		430813H Price gr. A519 (pce.)	430817H Price gr. A593 (pce.)	430821H Price gr. A645 (pair)	430825H Price gr. A593 (pce.)	
shell	<input checked="" type="checkbox"/> V3 431557H ⁹ Price gr. A423 (pce.)		431559H Price gr. A519 (pce.)	431561H Price gr. A593 (pce.)	431563H Price gr. A645 (pair)	431565H Price gr. A593 (pce.)	
sand	<input checked="" type="checkbox"/> V3 431558H ⁹ Price gr. A423 (pce.)		431560H Price gr. A519 (pce.)	431562H Price gr. A593 (pce.)	431564H Price gr. A645 (pair)	431566H Price gr. A593 (pce.)	

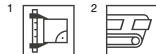

³ Also available in a length of 497 mm on request

⁴ Short edges rectified

⁵ Minimum order quantity: 10 pieces. In case of smaller quantities, the price must be individually calculated.

⁶ For further details concerning gutter tiles, refer to the Pool + Spa programme of delivery.

⁷ Stress group: 2

⁸ Stress group: 3

⁹ Stress group: 4

¹⁰ Color deviations compared to the adjoining covering due to production are no reason for complaint in case of horizontal laying.

Patio Tiles –
joint 3 mm¹

50 x 100 cm

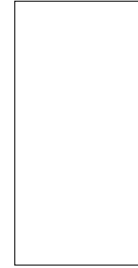

						50 x 100 / 20 x 40		Nom. dim. - cm/in
						497 x 997 x 20 mm		Work size - mm
						structured, matt		Surface
						2.000		m ² - pieces
						43.060		m ² - kg
						1		Bundle - pieces
						0.500		Bundle - m ²
						21.530		Bundle - kg
						22.500		Pallet - m ²
						968.850		Pallet - kg
						Alla		Product standard
						R11/B		Slip resistance
						3		Stress group
						430826H	4	
						Price gr. A277 (m ²)		pearl V3
						430827H	4	
						Price gr. A277 (m ²)		mud V3
						430828H	4	
						Price gr. A277 (m ²)		stone V3
						430829H	4	
						Price gr. A277 (m ²)		graphite V3
						431567H	4	
						Price gr. A277 (m ²)		sand V3







Modern and durable

Basic Stone was inspired by slate structures. The 5 x 5 cm mosaic's ceramic surface, made of unglazed porcelain stoneware with a Hytect finish, represents the theme of slate in a modern and durable way through a relief mix combined with discreet graphics. Glossy mica accents and subtle color contrasts highlight the stony character of the surface. The color palette draws from natural slate tones.

Rendering

Mosaic, 5 x 5 cm, 2 x 2 in



Mosaic sheet 30 x 30 cm, 12 x 12 in, black, structured, R10/B



Mosaic sheet 30 x 30 cm, 12 x 12 in, medium grey, structured, R10/B



Mosaic sheet 30 x 30 cm, 12 x 12 in, light grey, structured, R10/B



Mosaic sheet 30 x 30 cm, 12 x 12 in, mud, structured, R10/B



Mosaic sheet 30 x 30 cm, 12 x 12 in, beige, structured, R10/B



Mosaics glued thermoplastically on back of Agrob Buchtal can be used not only in dry zones but also without any problems in underwater areas (e.g. swimming pools/whirlpools) as well as in permanently wet areas (e.g. pool surrounds/showers).

Mosaic

5 x 5 cm

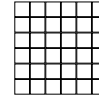

Sheet: 297 x 297 mm



					5 x 5 / 2 x 2	Nom. dim. - cm/in
					47 x 47 x 6.5 mm	Work size
					structured, matt	Surface
					11 sheets	m² - pieces
					12.331	m² - kg
					11 sheets	Bundle - pieces
					1.000	Bundle - m ²
					12.331	Bundle - kg
					64.000	Pallet - m ²
					789.184	Pallet - kg
					Bla	Product standard
					R10/B	Slip resistance
					1	Stress group
					42200H-73	
					Price gr. A211 (m ²)	black <input type="checkbox"/> V2
					42201H-73	
					Price gr. A211 (m ²)	medium grey <input type="checkbox"/> V2
					42202H-73	
					Price gr. A211 (m ²)	light-grey <input type="checkbox"/> V2
					42203H-73	
					Price gr. A211 (m ²)	mud <input type="checkbox"/> V2
					42204H-73	
					Price gr. A211 (m ²)	beige <input type="checkbox"/> V2







Timeless and simple

The timeless color palette and formats, ranging from 5 x 5 cm to 35 x 100 cm, offer economical solutions for various areas. The Basis Pro series enhances the existing collection by adding a selection of porcelain stoneware floor tiles with a contemporary and durable design. Additional features include high slip resistances ranging from R10/A to R13V10, as well as shower tub systems, stair tiles, and special pieces to complete the range.

Olympia-Stadion, Berlin, Germany / Architect: von Gerkan, Marg und Partner, Berlin / Photo: FSMK Architektur + Industriefotograf



Basis 1
Earthenware, glazed

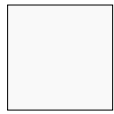

white, glossy

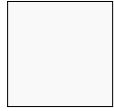

white, matt



white matt and glossy undulated

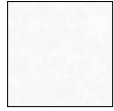

white, glossy, hammered



white, marbled, glossy and matt



pale grey, marbled, glossy and matt



beige, marbled, glossy and matt



sand-beige glossy and matt

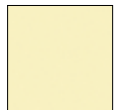

ivory, glossy

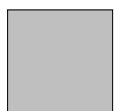

light grey, matt

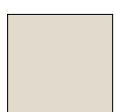

light-beige, matt



Listel Candy, 4.5 x 20 cm, 1 13/16 x 8 in



Listel Candy, 1 x 20 cm, 3/8 x 8 in

Basis 1+
Earthenware, glazed



white, glossy

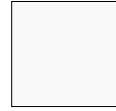

white, matt



white, glossy undulated



white, matt undulated

Basis 2
Earthenware, glazed

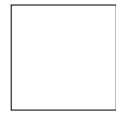

white, matt



white, glossy



grey, matt

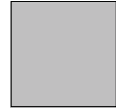

light grey, matt



light-beige, matt

Basis 3
Porcelain stoneware, unglazed



titanit



anthracite



medium grey



chalk



smooth R10/A and R10/B



Softcorn 2 R11/B



Perlstic R12



Opticorn R12V4



Picstic R12V8

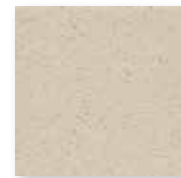

Roughened R13



Kombicorn R13V10

Basis 4
Stoneware tiles, glazed



white, glossy



white, matt



grey transparent matt



light-grey, matt



light-sahara, matt



soft azure, glossy



light-blue, glossy



azure dark, glossy

Wall Tiles

15 x 15 cm



15 x 15 cm



15 x 30 cm



20 x 20 cm



20 x 25 cm



20 x 40 cm



25 x 33 cm



15 x 15 / 6 x 6	15 x 15 / 6 x 6	15 x 30 cm / 6 x 12	20 x 20 / 8 x 8	20 x 25 / 8 x 10	20 x 40 / 8 x 16	25 x 33 / 10 x 13	Nom. dim. - cm/in
150 x 150 x 5.5 mm	147 x 147 x 5.5 mm	147 x 297 x 6.5 mm	197 x 197 x 6.0 mm	198 x 248 x 6.0 mm	197 x 397 x 7.5 mm	249 x 330 x 8.0 mm	Work size
smooth	smooth	smooth	smooth	smooth	smooth	smooth	Surface
44.000	44.000	22.222	25.000	20.000	12.500	12.121	m ² - pieces
9.504	9.416	10.622	10.800	10.260	12.975	12.969	m ² - kg
44	44	24	25	20	16	13	Bundle - pieces
1.000	1.000	1.080	1.000	1.000	1.280	1.073	Bundle - m ²
9.504	9.416	11.472	10.800	10.260	16.608	13.910	Bundle - kg
105.000	105.000	91.801	96.000	92.000	92.160	80.439	Pallet - m ²
997.920	988.680	975.120	1,036.800	943.920	1.195.776	1,043.250	Pallet - kg
BIII	BIII	BIII	BIII	BIII	BIII	BIII	Product standard
112000	531910-148	173368	532230-800	538020-400	182763	239996	white, glossy <input type="checkbox"/>
Price gr. A34 (m ²)	Price gr. A25 (m ²)	Price gr. A43 (m ²)	Price gr. A25 (m ²)	Price gr. A25 (m ²)	Price gr. A43 (m ²)	Price gr. A31 (m ²)	
115100	531911-148	173369	532212-800	538021-400	182764	239995	white, matt <input type="checkbox"/>
Price gr. A34 (m ²)	Price gr. A25 (m ²)	Price gr. A43 (m ²)	Price gr. A25 (m ²)	Price gr. A25 (m ²)	Price gr. A43 (m ²)	Price gr. A31 (m ²)	
						239998	white, glossy, undulated <input type="checkbox"/>
						Price gr. A34 (m ²)	
						239997	white, matt, undulated <input type="checkbox"/>
						Price gr. A34 (m ²)	
113063							white, glossy, hammered <input type="checkbox"/>
Price gr. A112 (m ²)							
111052							ivory, glossy <input type="checkbox"/>
Price gr. A112 (m ²)							
				538260-400		231032	light-grey, marbled, glossy <input type="checkbox"/>
				Price gr. A31 (m ²)		Price gr. A34 (m ²)	
				538261-400		231034	light-grey, marbled, matt <input type="checkbox"/>
				Price gr. A31 (m ²)		Price gr. A34 (m ²)	
				538280-400			beige marbled, glossy <input type="checkbox"/>
				Price gr. A31 (m ²)			
				538281-400			beige marbled, matt <input type="checkbox"/>
				Price gr. A31 (m ²)			
		173339	213341		183343		light-grey, matt <input type="checkbox"/>
		Price gr. A52 (m ²)	Price gr. A34 (m ²)		Price gr. A55 (m ²)		
		173340	213342		183344		light-beige, matt <input type="checkbox"/>
		Price gr. A52 (m ²)	Price gr. A34 (m ²)		Price gr. A55 (m ²)		

Wall Tiles

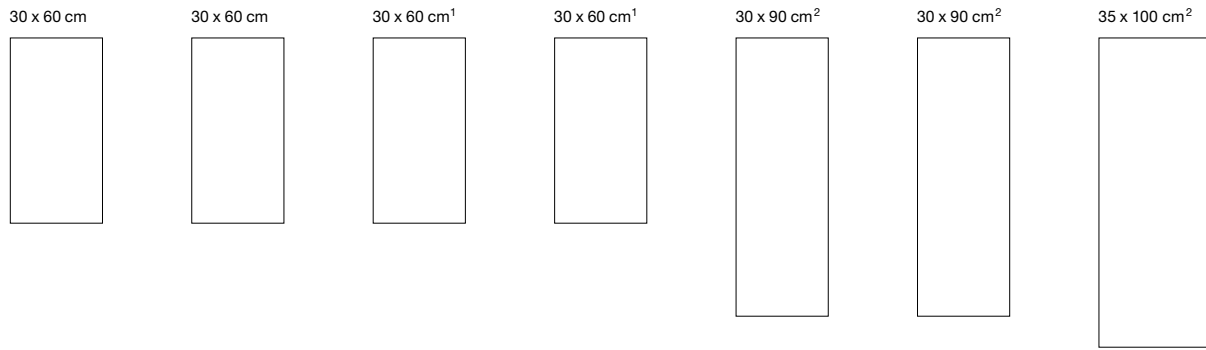

Nom. dim. - cm/in	30 x 60 / 12 x 24	30 x 60 / 12 x 24	30 x 60 / 12 x 24	30 x 60 / 12 x 24	30 x 90 / 12 x 36	30 x 90 / 12 x 36	35 x 100 / 14 x 40
Work size	297 x 597 x 9.0 mm	297 x 597 x 6.0 mm	297 x 597 x 6.0 mm	297 x 597 x 9.0 mm	297 x 897 x 6.0 mm	297 x 897 x 10.5 mm	347 x 997 x 6 mm
Surface	smooth	smooth	smooth	smooth	smooth	smooth	smooth
m ² - pieces	5.556	5.556	5.556	5.556	3.704	3.704	2.857
m ² - kg	14.946	10.279	10.279	15.279	10.400	17.976	10.108
Bundle - pieces	9	13	13	9	8	5	5
Bundle - m ²	1.620	2.340	2.340	1.620	2.160	1.350	1.750
Bundle - kg	24.210	24.050	24.050	24.750	22.464	24.265	17.690
Pallet - m ²	77.754	112.311	112.311	77.754	51.836	32.397	70.004
Pallet - kg	1,162.080	1,154.400	1,154.400	1,188.000	539.136	582.360	707.600
Product standard	BIII	BIII	BIII	BIII	BIII	BIII	BIII
white, glossy <input type="checkbox"/>	280374 Price gr. A34 (m ²)	203264 Price gr. A34 (m ²)	203459R Price gr. A52 (m ²)	282115R-02 Price gr. A79 (m ²)	323260 Price gr. A103 (m ²)	391589 Price gr. A124 (m ²)	363335 Price gr. A103 (m ²)
white, matt <input type="checkbox"/>	280375 Price gr. A34 (m ²)	203265 Price gr. A34 (m ²)	203460R Price gr. A52 (m ²)	282116R-02 Price gr. A79 (m ²)	323261 Price gr. A103 (m ²)	391590 Price gr. A124 (m ²)	363336 Price gr. A103 (m ²)
white, glossy, undulated <input type="checkbox"/>	280718 Price gr. A46 (m ²)						
white, matt, undulated <input type="checkbox"/>	280719 Price gr. A46 (m ²)						
white marbled, glossy <input type="checkbox"/>		203444 Price gr. A46 (m ²)					
white marbled, matt <input type="checkbox"/>		203445 Price gr. A46 (m ²)					
sand-beige, glossy <input type="checkbox"/>	280871 Price gr. A46 (m ²)						
sand-beige, matt <input type="checkbox"/>	280872 Price gr. A46 (m ²)						
light-grey, matt <input type="checkbox"/>	283345 Price gr. A46 (m ²)						
light-beige, matt <input type="checkbox"/>	283346 Price gr. A46 (m ²)						

Listel



Nom. dim. - cm/in	1 x 20 / 3/8 x 8	4.5 x 20 / 1 13/16 x 8				
Work size	10 x 197 x 6.0 mm	45 x 197 x 6.0 mm				
Surface	smooth, silky-matt	smooth, silky-matt				
m ² - pieces	5.000/m	5.000/m				
m ² - kg	0.125/m	0.505/m				
Bundle - pieces	100	72				
Bundle - m ²	20.000 m	14.400 m				
Bundle - kg	2.500	7.272				
Pallet - m ²						
Pallet - kg						
Product standard	BIII	BIII				
candy <input type="checkbox"/>	533436-198 Price gr. A423 (pce.)	533434-198 Price gr. A445 (pce.)				



Wall Tiles

30 x 60 cm



30 x 60 cm¹

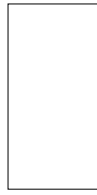

30 x 60 cm

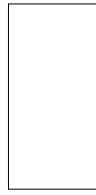

30 x 60 cm¹



30 x 90 cm²

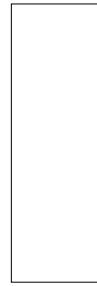

30 x 90 cm²



	30 x 60 / 12 x 24	30 x 60 / 12 x 24	30 x 60 / 12 x 24	30 x 60 / 12 x 24	30 x 90 / 12 x 36	30 x 90 / 12 x 36	Nom. dim. - cm/in
	297 x 597 x 9.0 mm	297 x 597 x 9.0 mm	297 x 597 x 6.0 mm	297 x 597 x 6.0 mm	297 x 897 x 10.5 mm	297 x 897 x 6 mm	Work size
	smooth	smooth	smooth	smooth	smooth	smooth	Surface
	5.556	5.556	5.556	5.556	3.704	3.704	m ² - pieces
	14.946	15.279	10.279	10.279	17.976	10.400	m ² - kg
	9	9	13	13	5	8	Bundle - pieces
	1.620	1.620	2.340	2.340	1.350	2.160	Bundle - m ²
	24.210	24.750	24.050	24.050	24.265	22.464	Bundle - kg
	77.754	77.754	112.311	112.311	32.397	51.836	Pallet - m ²
	1,162.080	1,188.000	1,154.400	1,154.400	582.360	539.136	Pallet - kg
	BIII	BIII	BIII	BIII	BIII	BIII	Product standard
	289358	282887R	203266H	203461HR	391572	323262H	white, glossy <input type="checkbox"/>
	Price gr. A55 (m ²)	Price gr. A94 (m ²)	Price gr. A46 (m ²)	Price gr. A64 (m ²)	Price gr. A139 (m ²)	Price gr. A115 (m ²)	white, matt <input type="checkbox"/>
	289359	282888R	203267H	203462HR	391573	323263H	white, glossy, undulated <input type="checkbox"/>
	Price gr. A55 (m ²)	Price gr. A94 (m ²)	Price gr. A46 (m ²)	Price gr. A64 (m ²)	Price gr. A139 (m ²)	Price gr. A115 (m ²)	white, matt, undulated <input type="checkbox"/>
	289360						
	Price gr. A61 (m ²)						
	289361						
	Price gr. A61 (m ²)						



Wall/Floor Tiles

5 x 5 cm¹



5 x 5 cm¹



10 x 10 cm¹



10 x 10 cm¹



15 x 15 cm



20 x 20 cm



30 x 60 cm²



Sheet: 297 x 297 mm

Sheet: 297 x 297 mm

Sheet: 297 x 297 mm

Sheet: 297 x 297 mm

Nom. dim. - cm/in	5 x 5 / 2 x 2	5 x 5 / 2 x 2	10 x 10 / 4 x 4	10 x 10 / 4 x 4	15 x 15 / 6 x 6	20 x 20 / 8 x 8	30 x 60 / 12 x 24
Work size	47 x 47 x 6.5 mm	47 x 47 x 6.5 mm	97 x 97 x 6.5 mm	97 x 97 x 6.5 mm	147 x 147 x 6.5 mm	197 x 197 x 6.5 mm	297 x 597 x 8.0 mm
Surface	smooth, matt	smooth, matt	smooth, matt	smooth, matt	smooth, matt	smooth, matt	smooth
m ² /m - pieces	11 sheets	11 sheets	11 sheets/m ²	11 sheets/m ²	44.000/m ²	25.000/m ²	5.556/m ²
m ² /m - kg	12.331	12.331	13.101/m ²	13.101/m ²	13.816/m ²	13.875/m ²	17.413/m ²
Bundle - pieces	11 sheets	11 sheets	11 sheets	11 sheets	44	25	6
Bundle - m ² /m	1.000	1.000	1.000 m ²	1.000 m ²	1.000 m ²	1.000 m ²	1.080 m ²
Bundle - kg	12.331	12.331	13.101	13.101	13.816	13.875	18.804
Pallet - m ²	64.000	64.000	64.000	64.000	80.000	72.000	43.197
Pallet - kg	789.184	789.184	838.464	838.464	1,105.280	999.000	752.160
Product standard	Blb	Blb	Blb	Blb	Blb	Blb	Alb
Slip resistance		R10/B		R10/B			
Stress group	1	1	1	1	1	1	1
	4 431006	4 431008	4 620811-504	4 600859-504	4 620805-504	4 620806-504	4 430964
white, matt	Price gr. A148 (m ²)	Price gr. A157 (m ²)	Price gr. A91 (m ²)	Price gr. A115 (m ²)	Price gr. A73 (m ²)	Price gr. A61 (m ²)	Price gr. A112 (m ²)
	4						4 430963
white, glossy							Price gr. A112 (m ²)
	4 431007	4 431009	4 620811-505	4 600859-505	4 620805-505	4 620806-505	
grey	Price gr. A148 (m ²)	Price gr. A157 (m ²)	Price gr. A91 (m ²)	Price gr. A115 (m ²)	Price gr. A73 (m ²)	Price gr. A61 (m ²)	
	4					4 430967	4 430965
light-grey, matt						Price gr. A94 (m ²)	Price gr. A127 (m ²)
	4					4 430968	4 430966
light-beige matt						Price gr. A94 (m ²)	Price gr. A127 (m ²)



Cove Skirting

10 x 10 cm³



Nom. dim. - cm/in	10 x 10 / 4 x 4						
Work size	100 x 97 x 6.0 mm						
Surface	smooth, matt						
m ² /m - pieces	10.000						
m ² /m - kg	1.500						
Bundle - pieces	40						
Bundle - m ² /m	4.000						
Bundle - kg	6.000						
Pallet - m ²							
Pallet - kg							
Product standard	Blb						
Slip resistance	R10/B						
	4 600864-504						
white, matt	Price gr. A413 (pce.)						
	4 600864-505						
grey	Price gr. A413 (pce.)						

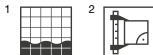

³ For details, refer to page 536 and the following

Wall/Floor Tiles

5 x 5 cm¹

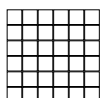

10 x 10 cm¹



15 x 15 cm



15 x 15 cm



20 x 20 cm



20 x 20 cm



20 x 20 cm



protected

Sheet: 297 x 297 mm

Sheet: 297 x 297 mm

Micro

Softcorn 2

Micro

Softcorn 2

Perlstic

5 x 5 / 2 x 2	10 x 10 / 4 x 4	15 x 15 / 6 x 6	15 x 15 / 6 x 6	20 x 20 / 8 x 8	20 x 20 / 8 x 8	20 x 20 / 8 x 8	Nom. dim. - cm/in
47 x 47 x 6.5 mm	97 x 97 x 6.5 mm	147 x 147 x 10.5 mm	147 x 147 x 10.5 mm	197 x 197 x 9.0 mm	197 x 197 x 9.0 mm	197 x 197 x 9.0 mm	Work size
smooth, matt	smooth, matt	smooth, matt	structured, matt	smooth, matt	structured, matt	fine-grained, matt	Surface
11 sheets	11 sheets	44.444	44.444	25.000	25.000	25.000	m ² - pieces
12.331	13.101	23.111	23.111	19.450	19.450	19.450	m ² - kg
11 sheets	11 sheets	27	27	25	25	25	Bundle - pieces
1.000	1.000	0.608	0.608	1.000	1.000	1.000	Bundle - m ²
12.331	13.101	14.040	14.040	19.450	19.450	19.450	Bundle - kg
64.000	64.000	48.600	48.600	60.000	60.000	60.000	Pallet - m ²
789.184	838.464	1,123.200	1,123.200	1,167.000	1,167.000	1,167.000	Pallet - kg
Bla	Bla	Bla	Bla	Bla	Bla	Bla	Product standard
R10/B	R10/B	R10/A	R11/B	R10/A	R11/B	R12	Slip resistance
1	1	3	3	2	2	2	Stress group
620510-070	620460-070	601500-070-71	601550-070-71	620249-070	620450-070	620470-070	titanit <input type="checkbox"/> V1
Price gr. A160 (m ²)	Price gr. A124 (m ²)	Price gr. A79 (m ²)	Price gr. A94 (m ²)	Price gr. A70 (m ²)	Price gr. A85 (m ²)	Price gr. A85 (m ²)	
620510-072	620460-072	601500-072-71	601550-072-71	620249-072	620450-072	620470-072	anthracite <input type="checkbox"/> V1
Price gr. A160 (m ²)	Price gr. A124 (m ²)	Price gr. A79 (m ²)	Price gr. A94 (m ²)	Price gr. A70 (m ²)	Price gr. A85 (m ²)	Price gr. A85 (m ²)	
620510-073	620460-073			620249-073	620450-073	620470-073	medium grey <input type="checkbox"/> V1
Price gr. A160 (m ²)	Price gr. A124 (m ²)			Price gr. A70 (m ²)	Price gr. A85 (m ²)	Price gr. A85 (m ²)	
620510-075	620460-075	601500-075-71	601550-075-71	620249-075	620450-075	620470-075	chalk <input type="checkbox"/> V1
Price gr. A160 (m ²)	Price gr. A124 (m ²)	Price gr. A79 (m ²)	Price gr. A94 (m ²)	Price gr. A70 (m ²)	Price gr. A85 (m ²)	Price gr. A85 (m ²)	



Wall/Floor Tiles

20 x 20 cm



20 x 20 cm²



20 x 20 cm



20 x 20 cm



30 x 30 cm

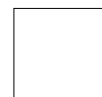

30 x 30 cm

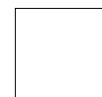

protected

Opticorn

Picstic

Geraut

Kombicorn

Micro

Softcorn 2

20 x 20 / 8 x 8	20 x 20 / 8 x 8	20 x 20 / 8 x 8	20 x 20 / 8 x 8	20 x 20 / 8 x 8	30 x 30 / 12 x 12	30 x 30 / 12 x 12	Nom. dim. - cm/in
197 x 197 x 9.0 mm	197 x 197 x 9.0 mm	197 x 197 x 9.0 mm	197 x 197 x 9.0 mm	197 x 197 x 9.0 mm	297 x 297 x 9.0 mm	297 x 297 x 9.0 mm	Work size
grained, matt	grained, matt	profiled, matt	profiled, matt	structured, matt	structured, matt	structured, matt	Surface
25.000	25.000	25.000	25.000	25.000	11.111	11.111	m ² - pieces
19.450	19.450	19.450	19.450	19.450	19.478	19.478	m ² - kg
25	25	25	25	25	13	13	Bundle - pieces
1.000	1.000	1.000	1.000	1.000	1.170	1.170	Bundle - m ²
19.450	19.450	19.450	19.450	19.450	22.789	22.789	Bundle - kg
60.000	60.000	60.000	60.000	60.000	56.161	56.161	Pallet - m ²
1,167.000	1,167.000	1,167.000	1,167.000	1,167.000	1,093.872	1,093.872	Pallet - kg
Bla	Bla	Bla	Bla	Bla	Bla	Bla	Product standard
R12V4	R12V8	R13	R13V10	R10	R11/B	R11/B	Slip resistance
2	2	2	2	2	2	2	Stress group
620290-070	620296-070				620241-070		titanit <input type="checkbox"/> V1
Price gr. A85 (m ²)	Price gr. A127 (m ²)				Price gr. A43 (m ²)		
620290-072	620296-072	620480-072	620490-072	620241-072	620241-072	620245-072	anthracite <input type="checkbox"/> V1
Price gr. A85 (m ²)	Price gr. A127 (m ²)	Price gr. A142 (m ²)	Price gr. A142 (m ²)	Price gr. A43 (m ²)	Price gr. A43 (m ²)	Price gr. A61 (m ²)	
620290-073				620241-073	620241-073		medium grey <input type="checkbox"/> V1
Price gr. A85 (m ²)				Price gr. A43 (m ²)	Price gr. A43 (m ²)		
620290-075	620296-075	620480-075	620490-075	620241-075	620241-075		chalk <input type="checkbox"/> V1
Price gr. A85 (m ²)	Price gr. A127 (m ²)	Price gr. A142 (m ²)	Price gr. A142 (m ²)	Price gr. A43 (m ²)	Price gr. A43 (m ²)		



² On request, also available in a thickness of 10.5 mm

Floor Tiles¹

Skirting, cut

Stair Tiles²

30 x 60 cm

30 x 60 cm

7 x 20 cm

7 x 30 cm

30 x 30 cm

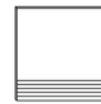
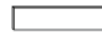

protected

Nom. dim. - cm/in	30 x 60 / 12 x 24	30 x 60 / 12 x 24	7 x 20 / 2 13/16 x 8	7 x 30 / 2 13/16 x 12	30 x 30 / 12 x 12		
Work size	297 x 597 x 9 mm	297 x 597 x 9 mm	70 x 197 x 9.0 mm	70 x 297 x 9.0 mm	297 x 297 x 9.0 mm		
Surface	smooth, matt	smooth, matt	smooth, matt	smooth, matt	smooth, matt		
m ² /m - pieces	5.556/m ²	5.556/m ²	5.000/m	3.333/m	3.333/m		
m ² /m - kg	19.907/m ²	19.907/m ²	1.400/m	1.399/m	5.906/m		
Bundle - pieces	7	7	60	50	11		
Bundle - m ² /m	1.260 m ²	1.260 m ²	12.000 m	15.001 m	3.300 m		
Bundle - kg	25.081	25.081	16.800	21.000	19.492		
Pallet - m ²	50.396	50.396					
Pallet - kg	1,003.240	1,003.240					
Product standard	Bla	Bla	Bla	Bla	Bla		
Slip resistance	R10/A	R11/B			R10		
Stress group	2	2			2		
titanit	436100 Price gr. A88 (m ²)	436104 Price gr. A115 (m ²)	600334-070 Price gr. A409 (pce.)	600384-070 Price gr. A410 (pce.)	600499-070 Price gr. A425 (pce.)		
anthracite	436101 Price gr. A88 (m ²)	436105 Price gr. A115 (m ²)	600334-072 Price gr. A409 (pce.)	600384-072 Price gr. A410 (pce.)	600499-072 Price gr. A425 (pce.)		
medium grey	436102 Price gr. A88 (m ²)	436106 Price gr. A115 (m ²)	600334-073 Price gr. A409 (pce.)	600384-073 Price gr. A410 (pce.)	600499-073 Price gr. A425 (pce.)		
chalk	436103 Price gr. A88 (m ²)	436107 Price gr. A115 (m ²)	600334-075 Price gr. A409 (pce.)	600384-075 Price gr. A410 (pce.)	600499-075 Price gr. A425 (pce.)		



Cove Skirting³

Internal Corner for Cove Skirting^{3/4}

External Corner for Cove Skirting^{3/4}

Shower Tub System⁵

10 x 10 cm

10 x 15 cm

10 x 20 cm

10 x 10 cm

10 x 10 cm



protected

Nom. dim. - cm/in	10 x 10 / 4 x 4	10 x 15 / 4 x 6	10 x 20 / 4 x 8			Softcorn Strip	Softcorn Corner
Work size	100 x 97 x 6.0 mm	102 x 147 x 9 mm	102 x 197 x 9.0 mm	102 x 20 x 9.0 mm	102 x 35 x 9.0 mm	97 x 97 x 9 mm	97 x 97 x 9 mm
Surface	smooth, matt	smooth, matt	smooth, matt	smooth, matt	smooth, matt	smooth, matt	grained, matt
m - pieces	10.000	6.667	5.000			10.000	
m/pce. - kg	1.500/m	2.000/m	2.000/m	0.080/Stück	0.080/Stück	2.020/m	0.202/Stück
Bundle - pieces	40	24	20	18	12	6	4
Bundle - m	4.000	3.600	4.000	1.440	0.960	0.600	0.808
Bundle - kg	6.000	7.200	8.000			1.212	
Pallet - m							
Pallet - kg							
Product standard	Bla	Bla	Bla	Bla	Bla	Bla	Bla
Slip resistance	R10/B	R10/A	R10/A			R11/B	R11/B
titanit	600450-070 Price gr. A409 (pce.)	600430-070-71 Price gr. A413 (pce.)	600420-070 Price gr. A413 (pce.)	600416-070 Price gr. A416 (pce.)	600417-070 Price gr. A416 (pce.)	600442-070 Price gr. A425 (pce.)	600443-070 Price gr. A451 (pce.)
anthracite	600450-072 Price gr. A409 (pce.)	600430-072-71 Price gr. A413 (pce.)	600420-072 Price gr. A413 (pce.)	600416-072 Price gr. A416 (pce.)	600417-072 Price gr. A416 (pce.)	600442-072 Price gr. A425 (pce.)	600443-072 Price gr. A451 (pce.)
mid-grey	600450-073 Price gr. A409 (pce.)		600420-073 Price gr. A413 (pce.)	600416-073 Price gr. A416 (pce.)	600417-073 Price gr. A416 (pce.)	600442-073 Price gr. A425 (pce.)	600443-073 Price gr. A451 (pce.)
chalk	600450-075 Price gr. A409 (pce.)	600430-075-71 Price gr. A413 (pce.)	600420-075 Price gr. A413 (pce.)	600416-075 Price gr. A416 (pce.)	600417-075 Price gr. A416 (pce.)	600442-075 Price gr. A425 (pce.)	600443-075 Price gr. A451 (pce.)

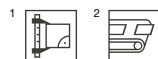

³ For details, refer to page 536 and the following

⁴ Fitting to cove skirting 10 x 15 cm and 10 x 20 cm.

⁵ For details, refer to page 534

Wall/Floor Tiles

25 x 12.5 cm



25 x 12.5 cm



25 x 12.5 cm



(8 mm thick)

(6 mm thick)

(8 mm thick)

				38110	18120	8110		Model number	
				25 x 12.5 / 10 x 5	25 x 12.5 / 10 x 5	25 x 12.5 / 10 x 5		Nom. dim. - cm/in	
				244 x 119 x 8 mm	244 x 119 x 6 mm	240 x 115 x 8 mm		Work size	
				smooth	smooth	smooth		Surface	
				32.000	32.000	32.000		m ² - pieces	
				15.680	12.160	14.720		m ² - kg	
				33	44	33		Bundle - pieces	
				1.031	1.375	1.000		Bundle - m ²	
				16.170	16.720	15.180		Bundle - kg	
				86.625	115.500	84.000		Pallet - m ²	
				1,358.280	1,404.480	1,275.120		Pallet - kg	
				Alb	Alb	Alb		Product standard	
				700-38110	700-18120	75917-8110	3		
				Price gr. A73 (m ²)	Price gr. A73 (m ²)	Price gr. A61 (m ²)		white, glossy	<input type="checkbox"/> VO
				701-38110	701-18120	75918-8110	4	white, matt	<input type="checkbox"/> VO
				Price gr. A73 (m ²)	Price gr. A73 (m ²)	Price gr. A61 (m ²)		grey	
					509-18120		4	transparent matt	<input type="checkbox"/> VO
					Price gr. A112 (m ²)			light-grey	
					711-18120		4	matt	<input type="checkbox"/> VO
					Price gr. A112 (m ²)				
				703-38110	703-18120		4	light-sahara matt	<input type="checkbox"/> VO
				Price gr. A112 (m ²)	Price gr. A112 (m ²)				
					732-18120		3	soft azure glossy	<input type="checkbox"/> VO
					Price gr. A112 (m ²)			light-blue	
						71152-8110	3	glossy	<input type="checkbox"/> VO
						Price gr. A112 (m ²)		azure dark	
					563-18120		1	glossy	<input type="checkbox"/> VO
					Price gr. A112 (m ²)				





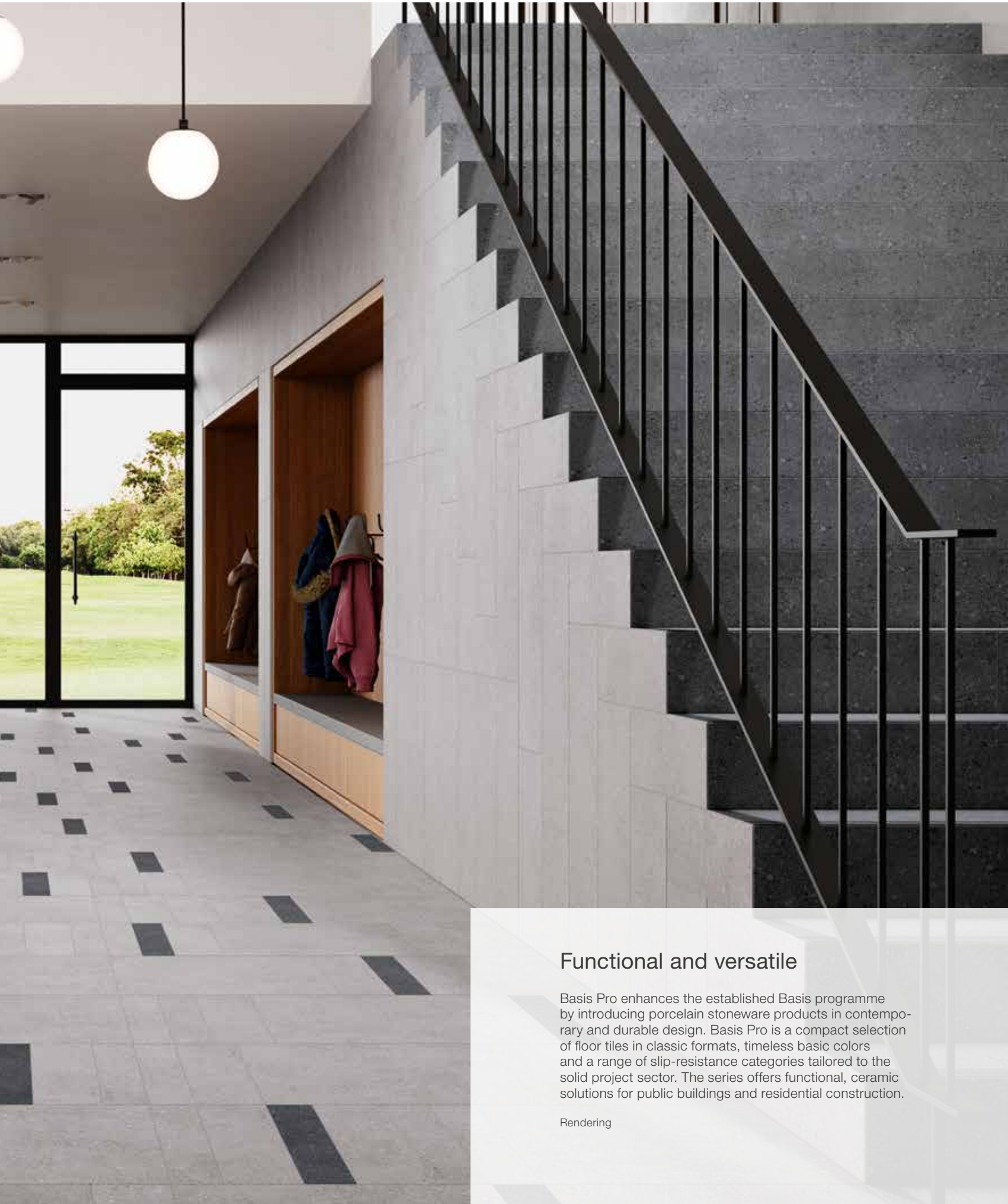

Functional and versatile

Basis Pro enhances the established Basis programme by introducing porcelain stoneware products in contemporary and durable design. Basis Pro is a compact selection of floor tiles in classic formats, timeless basic colors and a range of slip-resistance categories tailored to the solid project sector. The series offers functional, ceramic solutions for public buildings and residential construction.

Rendering



sand-beige



ash-brown



concrete-grey



basalt

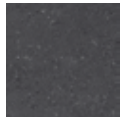

anthracite

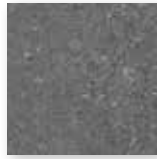

Floor tile 15 x 15 cm, 6 x 6 in
smooth, R10/B

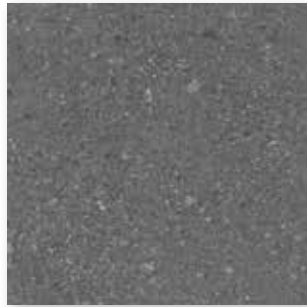

Floor tile 30 x 30 cm, 12 x 12 in, smooth, R10/A
Floor tile 30 x 30 cm, 12 x 12 in, smooth, R11/B



Floor tile 10 x 60 cm, 4 x 24 in, smooth, R10/A

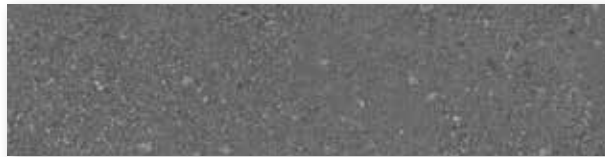

Floor tile 15 x 60 cm, 6 x 24 in, smooth, R10/A

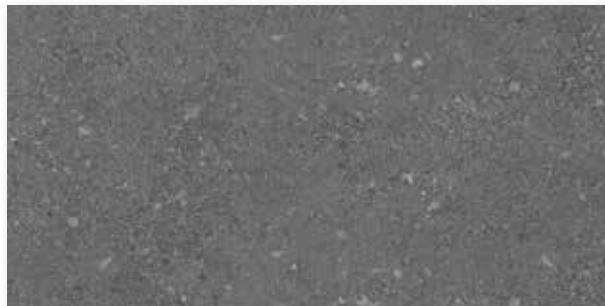

Floor tile 30 x 60 cm, 12 x 24 in, smooth, R10/A
Floor tile 30 x 60 cm, 12 x 24 in, smooth, R11/B
Floor tile 30 x 60 cm, 12 x 24 in, smooth, R12/C

Mosaic
5 x 5 cm, 2 x 2 in

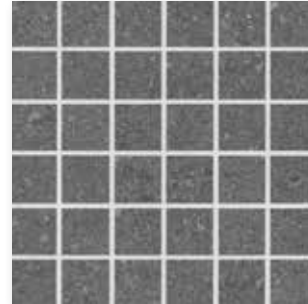

Mosaic sheet 30 x 30 cm, 12 x 12 in,
smooth, R10/B



Mosaics glued thermoplastically on back of Agrob Buchtal can be used not only in dry zones but also without any problems in underwater areas (e.g. swimming pools/whirlpools) as well as in permanently wet areas (e.g. pool surrounds/showers).

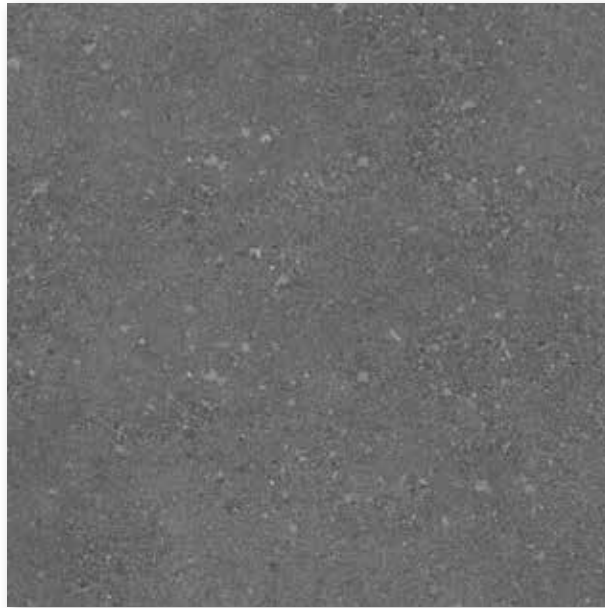

Floor tile 60 x 60 cm, 24 x 24 in, smooth, R10/A

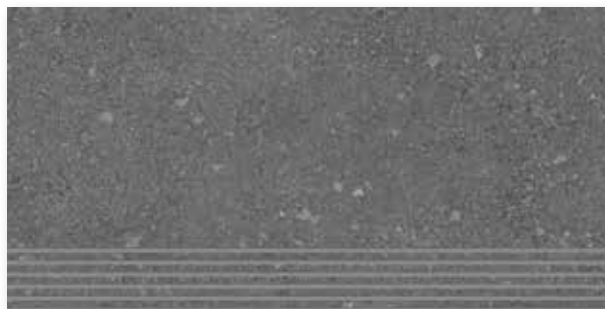

Stair tile 30 x 60 cm (with grooves), 12 x 24 in, smooth, R10/A



Skirting, rounded 7 x 60 cm, 2 13/16 x 24 in, smooth



Cove skirting 10 x 30 cm, 4 x 12 in, smooth, R10/A

Mosaic

Floor Tiles

5 x 5 cm¹



15 x 15 cm



30 x 30 cm



30 x 30 cm



30 x 30 cm^{3/4}



10 x 60 cm^{2/3}



15 x 60 cm^{2/3}

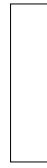

protected

Sheet 297 x 297 mm

extra thick

Oblong format

Oblong format

Nom. dim. - cm/in	5 x 5 / 2 x 2	15 x 15 / 6 x 6	30 x 30 / 12 x 12	30 x 30 / 12 x 12	30 x 30 / 12 x 12	10 x 60 / 4 x 24	15 x 60 / 6 x 24
Work size	47 x 47 x 6.5 mm	147 x 147 x 9 mm	297 x 297 x 9 mm	297 x 297 x 9 mm	297 x 297 x 14 mm	97 x 597 x 9 mm	147 x 597 x 9 mm
Surface	smooth, matt	smooth, matt	smooth, matt	smooth, matt	smooth, matt	smooth, matt	smooth, matt
m ² - pieces	11 sheets	44.444	11.111	11.111	11.337	16.667	11.111
m ² - kg	12.331	19.822	19.478	19.478	32.027	20.283	19.900
Bundle - pieces	11 sheets	32	13	13	8	17	13
Bundle - m ²	1.000	0.720	1.170	1.170	0.706	1.020	1.170
Bundle - kg	12.331	14.272	22.789	22.789	22.600	20.689	23.283
Pallet - m ²	64.000	57.601	56.161	56.161	33.871	40.799	46.800
Pallet - kg	789.184	1,141.760	1,093.880	1,093.872	1,084.800	827.560	931.311
Product standard	Bla	Bla	Bla	Bla	Bla	Bla	Bla
Slip resistance	R10/B	R10/B	R10/A	R11/B	R10	R10/A	R10/A
Stress group	1	2	2	2	4	2	2
sand-beige	430901 Price gr. A181 (m ²)	430906 Price gr. A109 (m ²)	430911 Price gr. A61 (m ²)	431045 Price gr. A61 (m ²)		430916 Price gr. A169 (m ²)	430921 Price gr. A169 (m ²)
ash-brown	430902 Price gr. A181 (m ²)	430907 Price gr. A109 (m ²)	430912 Price gr. A61 (m ²)	431046 Price gr. A61 (m ²)		430917 Price gr. A169 (m ²)	430922 Price gr. A169 (m ²)
concrete-grey	430903 Price gr. A181 (m ²)	430908 Price gr. A109 (m ²)	430913 Price gr. A61 (m ²)	431047 Price gr. A61 (m ²)	430993	430918 Price gr. A169 (m ²)	430923 Price gr. A169 (m ²)
basalt	430904 Price gr. A181 (m ²)	430909 Price gr. A109 (m ²)	430914 Price gr. A61 (m ²)	431048 Price gr. A61 (m ²)		430919 Price gr. A169 (m ²)	430924 Price gr. A169 (m ²)
anthracite	430905 Price gr. A181 (m ²)	430910 Price gr. A109 (m ²)	430915 Price gr. A61 (m ²)	431049 Price gr. A61 (m ²)		430920 Price gr. A169 (m ²)	430925 Price gr. A169 (m ²)



⁴ Prices are calculated project-specifically

Floor Tiles

30 x 60 cm¹



30 x 60 cm^{2/3/4}

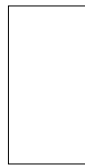

30 x 60 cm¹



30 x 60 cm¹



60 x 60 cm¹



60 x 60 cm^{2/3/4}



protected

	<i>extra thick</i>				<i>extra thick</i>		
	30 x 60 / 12 x 24	30 x 60 / 12 x 24	30 x 60 / 12 x 24	30 x 60 / 12 x 24	60 x 60 / 24 x 24	60 x 60 / 24 x 24	Nom. dim. - cm/in
	297 x 597 x 9 mm	300 x 600 x 14 mm	297 x 597 x 9 mm	297 x 597 x 9 mm	597 x 597 x 9 mm	600 x 600 x 14 mm	Work size
	smooth, matt	smooth, matt	smooth, matt	smooth, matt	smooth, matt	smooth, matt	Surface
	5.556	5.589	5.556	5.556	2.778	2.778	m ² - pieces
	19.907	32.159	19.907	19.907	20.371	31.669	m ² - kg
	7	4	7	7	3	2	Bundle - pieces
	1.260	0.716	1.260	1.260	1.080	0.720	Bundle - m ²
	25.081	23.016	25.081	25.081	21.999	22.800	Bundle - kg
	50.396	28.628	50.396	50.396	45.356	30.238	Pallet - m ²
	1,003.240	920.640	1,003.240	1,003.240	923.958	957.600	Pallet - kg
	Bla	Bla	Bla	Bla	Bla	Bla	Product standard
	R10/A	R10	R11/B	R12/C	R10/A	R10	Slip resistance
	2	3 - 4	2	2	2	3 - 4	Stress group
	430926	430997	430931	430936	430941	430979	sand-beige <input type="checkbox"/> V2
	Price gr. A106 (m ²)		Price gr. A106 (m ²)	Price gr. A124 (m ²)	Price gr. A121 (m ²)		
	430927	430996	430932	430937	430942	430978	ash-brown <input type="checkbox"/> V2
	Price gr. A106 (m ²)		Price gr. A106 (m ²)	Price gr. A124 (m ²)	Price gr. A121 (m ²)		
	430928	430995	430933	430938	430943	430977	concrete-grey <input type="checkbox"/> V2
	Price gr. A106 (m ²)		Price gr. A106 (m ²)	Price gr. A124 (m ²)	Price gr. A121 (m ²)		
	430929		430934	430939	430944		basalt <input type="checkbox"/> V2
	Price gr. A106 (m ²)		Price gr. A106 (m ²)	Price gr. A124 (m ²)	Price gr. A121 (m ²)		
	430930		430935	430940	430945		anthracite <input type="checkbox"/> V2
	Price gr. A106 (m ²)		Price gr. A106 (m ²)	Price gr. A124 (m ²)	Price gr. A121 (m ²)		

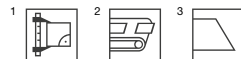

⁴ Prices are calculated project-specifically



Cove Skirting, decorated^{3/4} Stair Tile^{1/2} Skirting, rounded¹

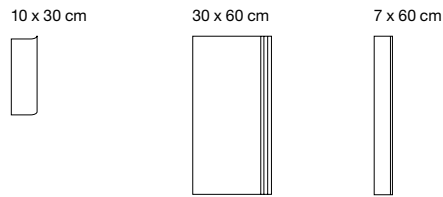

Nom. dim. - cm/in	10 x 30 / 4 x 12	30 x 60 / 12 x 24	7 x 60 / 2 13/16 x 24			
Work size	102 x 297 x 9 mm	297 x 597 x 9 mm	70 x 597 x 9 mm			
Surface	smooth, matt	smooth, matt	smooth, matt			
m - pieces	3.333	1.667	1.667			
m - kg	1.999	5.973	1.357			
Bundle - pieces	16	7	15			
Bundle - m	4.800	4.199	8.998			
Bundle - kg	9.600	25.081	12.210			
Pallet - m ²						
Pallet - kg						
Product standard	Bla	Bla	Bla			
Slip resistance	R10/A	R10/A				
Stress group		2				
	430946	<i>430951</i>	430956			
sand-beige <input type="checkbox"/> V2	Price gr. A422 (pce.)	<i>Price gr. A456 (pce.)</i>	Price gr. A438 (pce.)			
	430947	<i>430952</i>	430957			
ash-brown <input type="checkbox"/> V2	Price gr. A422 (pce.)	<i>Price gr. A456 (pce.)</i>	Price gr. A438 (pce.)			
	430948	<i>430953</i>	430958			
concrete-grey <input type="checkbox"/> V2	Price gr. A422 (pce.)	<i>Price gr. A456 (pce.)</i>	Price gr. A438 (pce.)			
	430949	<i>430954</i>	430959			
basalt <input type="checkbox"/> V2	Price gr. A422 (pce.)	<i>Price gr. A456 (pce.)</i>	Price gr. A438 (pce.)			
	430950	<i>430955</i>	430960			
anthracite <input type="checkbox"/> V2	Price gr. A422 (pce.)	<i>Price gr. A456 (pce.)</i>	Price gr. A438 (pce.)			

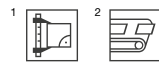

³ For details, refer to page 536

⁴ Color deviations compared to the adjoining covering due to production are no reason for complaint in case of horizontal laying.

Rendering



Maximiliancenter at the central railway station, Bonn, Germany / Architect: Forum Architekten & Planners BV
Series: Orientation Aids for the Blind / Photo: Jochen Stüber

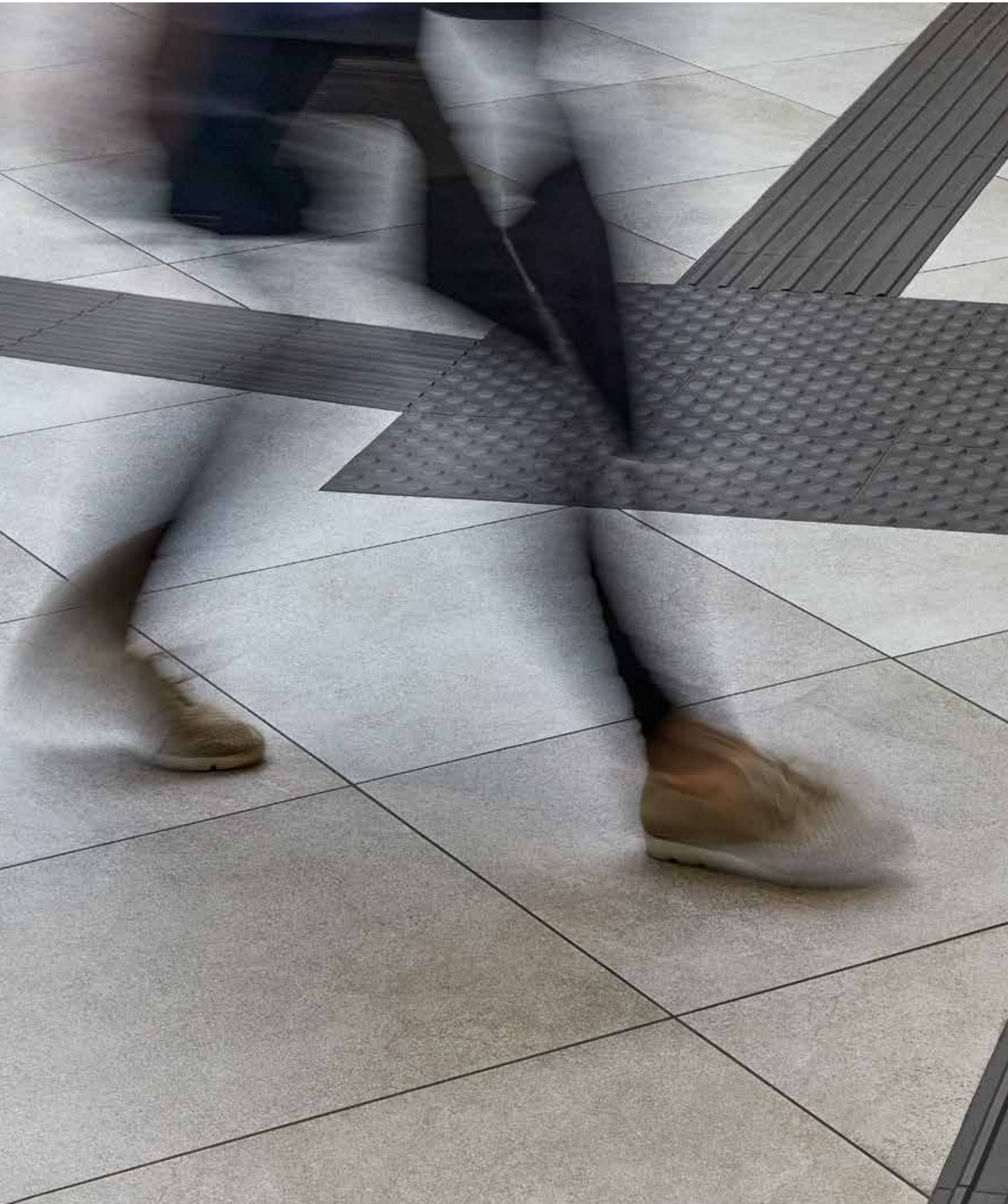



Guide Tiles

Floor Tile

30 x 30 cm



30 x 30 cm



30 x 30 cm



protected

				30 x 30 / 12 x 12	30 x 30 / 12 x 12	30 x 30 / 12 x 12	Nom. dim. - cm/in
				297 x 297 x 10.5 mm	297 x 297 x 10.5 mm	297 x 297 x 10.5 mm	Work size
				ribbed structure	knob structure	smooth, matt	Surface
				3.333/m	3.333/m	11.111/m ²	m/m ² - pieces
				7.999/m	7.999/m	23.144/m ²	m/m ² - kg
				8	8	11	Bundle - pieces
				2.400 m	2.400 m	0.990 m ²	Bundle - m/m ²
				19.200	19.200	22.913	Bundle - kg
						47.520	Pallet - m ²
						1,099.824	Pallet - kg
				Bla	Bla	Bla	Product standard
				R11	R11	R11	Slip resistance
				3	3	3	Stress group
				600356-103-70	600355-103-70	600357-103-70	chalk <input type="checkbox"/> V0
				Price gr. A455 (pce.)	Price gr. A539 (pce.)	Price gr. A190 (m ²)	
				600356-106-70	600355-106-70	600357-106-70	graphite <input type="checkbox"/> V0
				Price gr. A455 (pce.)	Price gr. A539 (pce.)	Price gr. A190 (m ²)	
				430304H-R	430304H-N	430304-N	Area Pro
				Price gr. A455 (pce.)	Price gr. A539 (pce.)	Price gr. A190 (m ²)	anthracite <input type="checkbox"/> V2
				430312H-R	430312H-N	430312-N	Area Pro
				Price gr. A455 (pce.)	Price gr. A539 (pce.)	Price gr. A190 (m ²)	platinum <input type="checkbox"/> V2





Floor tile 15.4 x 15.4 cm, 6 3/16 x 6 3/16 in, ribbed structure, chalk, R11



Floor tile 15.4 x 15.4 cm, 6 3/16 x 6 3/16 in, ribbed structure, anthracite, R11

Guide tile: 6635

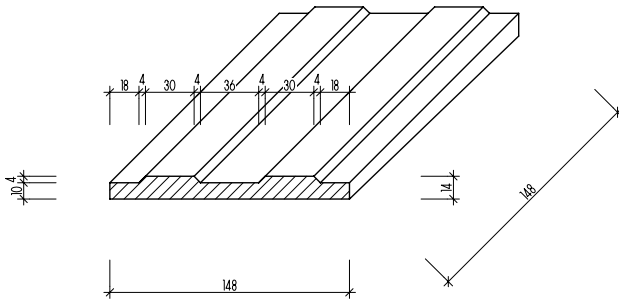

Guide tile: 6636

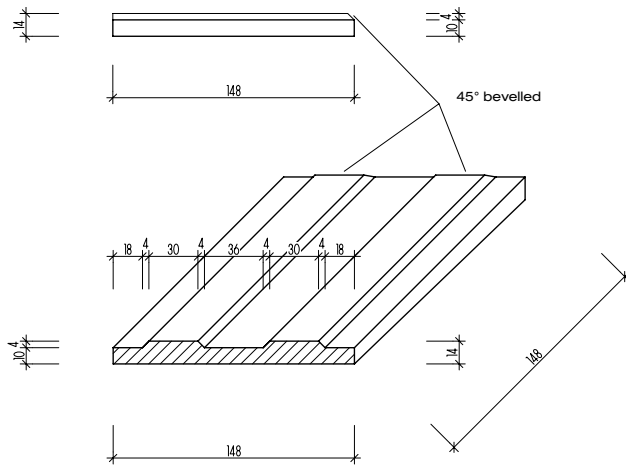

Guide Tiles^{1/2/3}

15,4 x 15,4 cm



ribbed structure

15,4 x 15,4 cm



bevelled on one side,
ribbed structure

					6635	6636	Model number
					15.4 x 15.4 / 63/16 x 63/16	15.4 x 15.4 / 63/16 x 63/16	Nom. dim. - cm/in
					148 x 148 x 10 mm	148 x 148 x 10 mm	Work size
					ribbed structure	ribbed structure	Surface
					6.494	6.494	m - pieces
					3.318	3.318	m - kg
					20	20	Bundle - pieces
					3.080	3.080	Bundle - m
					10.220	10.220	Bundle - kg
							Pallet - m
							Pallet - kg
					Alb	Alb	Product standard
					R11	R11	Slip resistance
					3	3	Stress group
					103197-6635	103197-6636	
					Price gr. A428 (pce.)	Price gr. A442 (pce.)	chalk <input type="checkbox"/>
					101630-6635	101630-6636	
					Price gr. A428 (pce.)	Price gr. A442 (pce.)	anthracite <input type="checkbox"/>



³ Short edge rectified







Noble marble look

The natural expression of Italian marble and the generous format make Bliss truly special. The combination of the basic tiles with the freshly colored Paradise surface décor is particularly striking. The basic tiles harmonize with various floor tile series and are Hytect-coated, making them especially hygienic.

Rendering



Wall tile 35 x 100 cm, 14 x 40 in, white calacatta, smooth

Decoration Elements



Decorative tile Paradise 35 x 100 cm, 14 x 40 in, green-blue Mix, smooth

Wall Tiles¹

Decoration
Elements^{1/2/3}

35 x 100 cm



35 x 100 cm

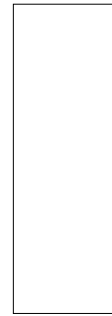

35 x 100 cm



Decorative tile Paradise

				35 x 100 / 14 x 40	35 x 100 / 14 x 40	35 x 100 / 14 x 40	
				347 x 997 x 6 mm	347 x 997 x 6 mm	347 x 997 x 6 mm	Nom. dim - cm/in
				smooth, silky-matt	smooth, glossy	smooth, silky-matt	Work size
				2.857	2.857	2.857	Surface
				10.108	10.108	10.108	m ² - pieces
				5	5	5	m ² - kg
				1.750	1.750	1.750	Bundle - pieces
				17.690	17.690	17.690	Bundle - m ²
				70.004	70.004	70.004	Bundle - kg
				707.600	707.600	707.600	Pallet - m ²
				BIII	BIII	BIII	Pallet - kg
				363428H	363429H	363430H	Product standard
				Price gr. C134 (m ²)	Price gr. C134 (m ²)	Price gr. C143 (m ²)	white calacatta <input type="checkbox"/> V3
							green-blue Mix <input type="checkbox"/> V4



² Decoration elements only available in full boxes.

³ The decoration you have chosen is a high-quality product made of glazed earthenware. The decoration consists of different individual pictures. The connections of the individual pictures are deliberately designed freely and thus do not connect in the continuous laying. The composition of the motifs in the box may vary due to production reasons..





Inspired by wood

With its subtle evocation of wood surfaces, Cedra is the perfect choice for a homely bathroom design. The two wall tile colors available in two formats can be harmoniously combined with the borders. These borders, available with or without porcelain stoneware inlays, create visual accents and echo the three classic colors of the floor tiles. Particularly practical: in addition to the floor tile, the shower area can be continued with a matching mosaic in R10/B. Thanks to their Hytect surface, the wall tiles are especially easy to clean.

Rendering



Wall tile 30 x 60 cm, 12 x 24 in, white-cream, smooth



Wall tile 30 x 60 cm, 12 x 24 in, beige, smooth

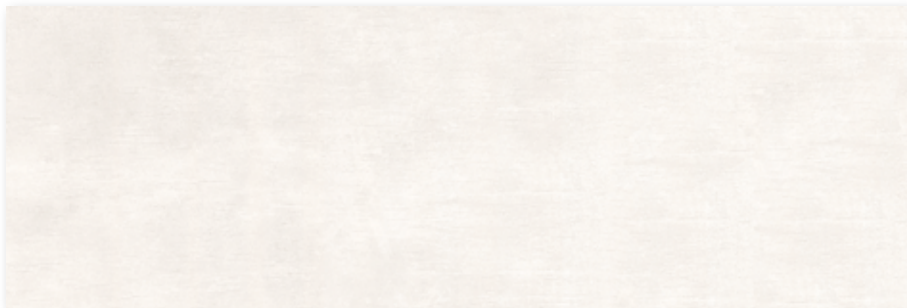

Wall tile 30 x 90 cm, 12 x 36 in, white-cream, smooth



Wall tile 30 x 90 cm, 12 x 36 in, beige, smooth

Decoration Elements



Border with porcelain stoneware insert 10 x 60 cm, 4 x 24 in, grey, smooth



Border with porcelain stoneware insert 10 x 60 cm, 4 x 24 in, anthracite, smooth



Border with porcelain stoneware insert 10 x 60 cm, 4 x 24 in, mud, smooth



Border 10 x 60 cm, 4 x 24 in, grey, smooth



Border 10 x 60 cm, 4 x 24 in, anthracite, smooth

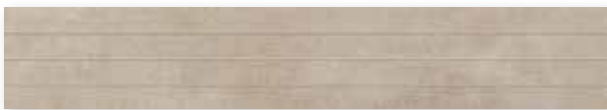

Border 10 x 60 cm, 4 x 24 in, mud, smooth

Decoration Elements



Border with porcelain stoneware insert 10 x 90 cm, 4 x 36 in, grey, smooth



Border with porcelain stoneware insert 10 x 90 cm, 4 x 36 in, anthracite, smooth



Border with porcelain stoneware insert 10 x 90 cm, 4 x 36 in, mud, smooth



Border 10 x 90 cm, 4 x 36 in, grey, smooth



Border 10 x 90 cm, 4 x 36 in, anthracite, smooth



Border 10 x 90 cm, 4 x 36 in, mud, smooth

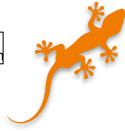

anthracite



grey



mud



Floor tile 30 x 60 cm, 12 x 24 in, smooth, R9



Skirting, rounded 7 x 60 cm, 2 13/16 x 24 in, smooth

Mosaic 5 x 5 cm, 2 x 2 in



Mosaic sheet 30 x 30 cm, 12 x 12 in, anthracite, smooth, R10/B

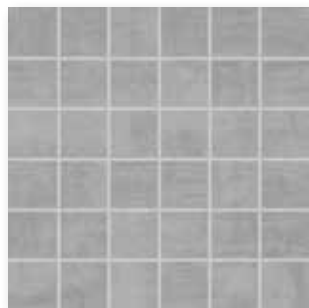

Mosaic sheet 30 x 30 cm, 12 x 12 in, grey, smooth, R10/B



Mosaic sheet 30 x 30 cm, 12 x 12 in, mud, smooth, R10/B

Mosaic: glass fibre net on reverse side,
Sheet: 297 x 297 mm

Wall Tile

Decoration Elements^{2/3/4/5/6}

30 x 60 cm



30 x 90 cm¹

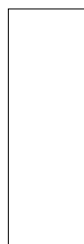

10 x 60 cm



10 x 60 cm



10 x 90 cm



10 x 90 cm



Nom. dim - cm/in	30 x 60 / 12 x 24	30 x 90 / 12 x 36	10 x 60 / 4 x 24	10 x 60 / 4 x 24	10 x 90 / 4 x 36	10 x 90 / 4 x 36
Work size	297 x 597 x 9 mm	297 x 897 x 10.5 mm	97 x 597 x 10.5 mm	97 x 597 x 10.5 mm	97 x 897 x 10.5 mm	97 x 897 x 10.5 mm
Surface	smooth, silky-matt	smooth, silky-matt	smooth, matt	smooth, matt	smooth, matt	smooth, matt
m ² /m - pieces	5.556/m ²	3.704/m ²	1.667/m	1.667/m	1.111/m	1.111/m
m ² /m - kg	14.946/m ²	17.976/m ²	2.167/m	2.167/m	2.166/m	2.166/m
Bundle - pieces	9	5	4	4	2	2
Bundle - m ² /m	1.620 m ²	1.350 m ²	2.400 m	2.400 m	1.800 m	1.800 m
Bundle - kg	24.210	24.265	5.200	5.200	3.900	3.900
Pallet - m ²	77.754	32.397				
Pallet - kg	1,162.080	582.360				
Product standard	BIII	BIII	Bla	Bla	Bla	Bla
	281726	392720				
white-cream	Price gr. C89 (m ²)	Price gr. C149 (m ²)				
	281727	392721				
beige	Price gr. C89 (m ²)	Price gr. C149 (m ²)				
			281728	281729	392723	392724
grey			Price gr. C474 (pce.)	Price gr. C466 (pce.)	Price gr. C491 (pce.)	Price gr. C486 (pce.)
			281730	281731	392725	392726
anthracite			Price gr. C474 (pce.)	Price gr. C466 (pce.)	Price gr. C491 (pce.)	Price gr. C486 (pce.)
			281732	281733	392727	392728
mud			Price gr. C474 (pce.)	Price gr. C466 (pce.)	Price gr. C491 (pce.)	Price gr. C486 (pce.)



⁵ Glass fibre net on reverse side
⁶ Decoration elements only available in full boxes.

Mosaic^{1/2}

5 x 5 cm



Floor Tiles¹

30 x 60 cm



Skirting,
rounded¹

7 x 60 cm



protected

Sheet: 297 x 297 mm

				5 x 5 / 2 x 2	30 x 60 / 12 x 24	7 x 60 / 2 13/16 x 24	Nom. dim - cm/in
				47 x 47 x 10.5 mm	297 x 597 x 10.5 mm	70 x 597 x 10.5 mm	Work size
				smooth, matt	smooth, matt	smooth, matt	Surface
				11.111 sheets/m ²	5.556/m ²	1.667/m	m ² /m - pieces
				22.222/m ²	23.224/m ²	1.584/m	m ² /m - kg
				11 sheets	6	22	Bundle - pieces
				0.990 m ²	1.080 m ²	13.197 m	Bundle - m ² /m
				22.000	25.080	20.900	Bundle - kg
				29.700	43.197		Pallet - m ²
				660.000	1,003.200		Pallet - kg
				Bla	Bla	Bla	Product standard
				R10/B	R9		Slip resistance
				2	2		Stress group
				433757	433692	433695	anthracite <input type="checkbox"/> V2
				Price gr. C314 (m ²)	Price gr. C116 (m ²)	Price gr. C440 (pce.)	
				433756	433693	433696	grey <input type="checkbox"/> V2
				Price gr. C314 (m ²)	Price gr. C116 (m ²)	Price gr. C440 (pce.)	
				433758	433694	433697	mud <input type="checkbox"/> V3
				Price gr. C314 (m ²)	Price gr. C116 (m ²)	Price gr. C440 (pce.)	



² Glass fibre net on reverse side





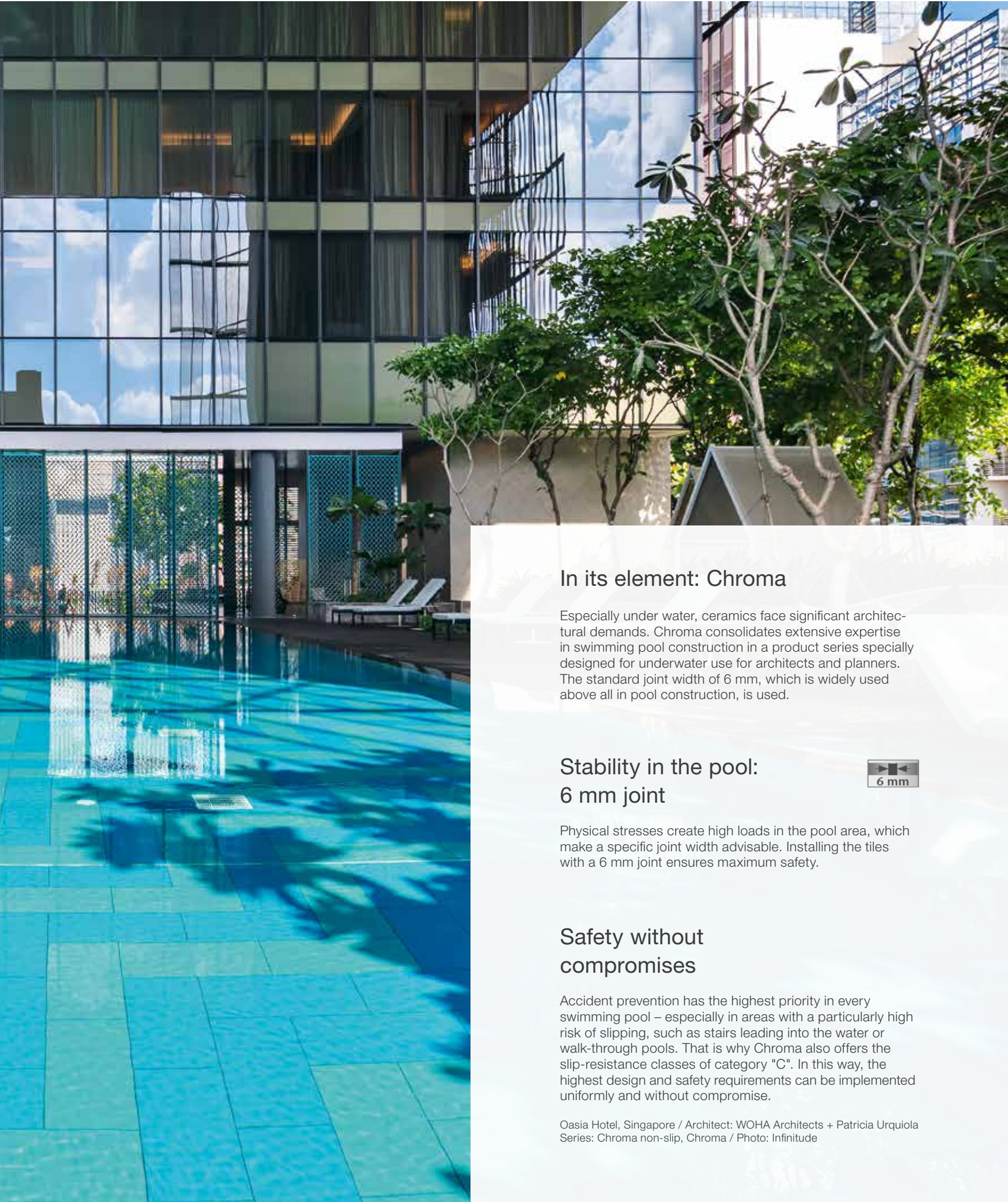

In its element: Chroma

Especially under water, ceramics face significant architectural demands. Chroma consolidates extensive expertise in swimming pool construction in a product series specially designed for underwater use for architects and planners. The standard joint width of 6 mm, which is widely used above all in pool construction, is used.

Stability in the pool: 6 mm joint



Physical stresses create high loads in the pool area, which make a specific joint width advisable. Installing the tiles with a 6 mm joint ensures maximum safety.

Safety without compromises

Accident prevention has the highest priority in every swimming pool – especially in areas with a particularly high risk of slipping, such as stairs leading into the water or walk-through pools. That is why Chroma also offers the slip-resistance classes of category "C". In this way, the highest design and safety requirements can be implemented uniformly and without compromise.

Oasia Hotel, Singapore / Architect: WOHA Architects + Patricia Urquiola
Series: Chroma non-slip, Chroma / Photo: Infinitude

COLOR SYSTEM UNICOLOR – A color sphere becomes a sphere of possibilities



active ochre NCS S 3050-Y40R	active salmon NCS S 4040-Y70R	active oxid red NCS S 4050-Y90R	active stone grey NCS S 5030-Y90R	active sand-grey NCS S 7010-Y90R
light ochre NCS S 2030-Y20R	light salmon NCS S 1515-Y50R	light oxid red NCS S 2010-Y80R	light stone grey NCS S 2502-R	light sand-grey NCS S 1502-Y
medium ochre NCS S 3030-Y30R	medium salmon NCS S 2020-Y50R	medium oxid red NCS S 3020-Y80R	medium stone grey NCS S 3502-R or RAL 7036	medium sand-grey NCS S 3005-Y50R
dark ochre NCS S 4030-Y50R	dark salmon NCS S 3040-Y60R	dark oxid red NCS S 5020-Y80R	dark stone grey NCS S 6005-Y80R	dark sand-grey NCS S 6010-Y50R
ochre	salmon	oxid red	stone grey	sand-grey
neutral 3 (asphalt black) NCS S 6500-N	neutral 2 (anthracite) NCS S 7500-N or RAL 7015	neutral 1 (deep black) NCS S 9000-N or RAL 9017		

Contrasting colors (glossy)

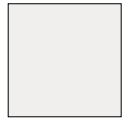

701
neutral 10 (active white)

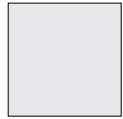

552119
neutral 9 (white-grey)



552118
neutral 8 (light-grey)



552117
neutral 7 (pebble-grey)



552115
neutral 5 (basalt-grey)



552113
neutral 3 (asphalt black)



552112
neutral 2 (anthracite)



5716
neutral 1 (deep black)



552004
dark azure



552008
dark blue



552012
dark turquoise



552016
dark green



552020
dark yellow



552024
dark ochre



552028
dark salmon



552032
dark oxid red



552036
dark stone grey



552040
dark sand-grey



552003
medium azure



552007
medium blue



552011
medium turquoise



552015
medium green



552019
medium yellow



552023
medium ochre



552027
medium salmon



552031
medium oxid red



552035
medium stone grey



552039
medium sand-grey



552002
light azure



552006
light blue



552010
light turquoise



552014
light green



552018
light yellow



552022
light ochre



552026
light salmon



552030
light oxid red



552034
light stone grey



552038
light sand-grey



552001
active azure



552005
active blue



552009
active turquoise



552013
active green



552017
active yellow



552021
active ochre



552025
active salmon



552029
active oxid red



552033
active stone grey



552037
active sand-grey

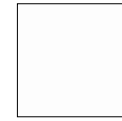

700
white



151
orange



154
contrasting red



152
apple-green



717
black



150
lemon-yellow



144
intense blue



153
violet



Floor/Wall tile
6.2 x 25 cm, 2 1/2 x 10 in,
smooth

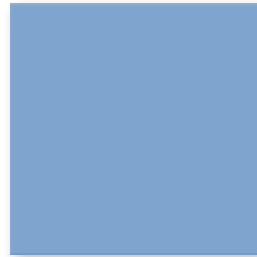

Floor/Wall tile
25 x 25 cm, 10 x 10 in,
smooth



Floor/Wall tile
12.5 x 12.5 cm, 5 x 5 in,
smooth



Floor/Wall tile
25 x 50 cm, 10 x 20 in, smooth

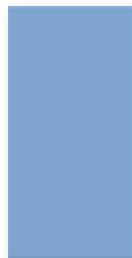

Floor/Wall tile
12.5 x 25 cm, 5 x 10 in,
smooth

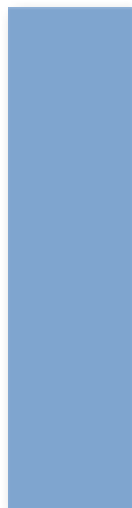

Floor/Wall tile
12.5 x 50 cm, 5 x 20 in,
smooth

Floor/Wall Tiles

6.2 x 25 cm^{3/6}



12.5 x 12.5 cm^{3/6}



12.5 x 25 cm³



12.5 x 50 cm¹

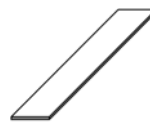

25 x 25 cm³



25 x 50 cm¹

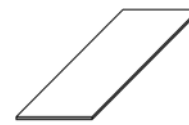

Model number	18210H	12020H	18120H	41550HK	12050H	42550HK
Nom. dim. - cm/in	6.2 x 25 / 2 1/2 x 10	12.5 x 12.5 / 5 x 5	12.5 x 25 / 5 x 10	12.5 x 50 / 5 x 20	25 x 25 / 10 x 10	25 x 50 / 10 x 20
Work size	56 x 244 x 6 mm	119 x 119 x 6 mm	119 x 244 x 6 mm	119 x 494 x 8 mm	244 x 244 x 6 mm	244 x 494 x 8 mm
Surface	smooth, silky-matt ⁵	smooth, silky-matt ⁵	smooth, silky-matt ⁵	smooth, silky-matt ⁵	smooth, silky-matt ⁵	smooth, silky-matt ⁵
m ² - pieces	64.000	64.000	32.000	16.000	16.000	8.000
m ² - kg	10.880	12.160	12.160	17.040	12.800	17.040
Bundle - pieces	88	88	44	8	18	9
Bundle - m ²	1.375	1.375	1.375	0.500	1.125	1.125
Bundle - kg	14.960	16.720	16.720	8.520	14.400	19.170
Pallet - m ²	132.000	115.500	115.500	55.000	91.125	40.500
Pallet - kg	1,436.160	1,404.480	1,404.480	937.200	1,166.400	690.120
Product standard	Alb	Alb	Alb	Alb	Alb	Alb
neutral 10 (active white glossy) <input type="checkbox"/>	4 700i-18210H Price gr. A157 (m ²)	700i-12020H Price gr. A157 (m ²)	700i-18120H Price gr. A94 (m ²)	700i-41550HK Price gr. A178 (m ²)	700i-12050H Price gr. A157 (m ²)	700i-42550HK Price gr. A157 (m ²)
neutral 10 (active white matt) <input type="checkbox"/>	4 701i-18210H Price gr. A157 (m ²)	701i-12020H Price gr. A157 (m ²)	701i-18120H Price gr. A94 (m ²)	701i-41550HK Price gr. A178 (m ²)	701i-12050H Price gr. A157 (m ²)	701i-42550HK Price gr. A157 (m ²)
neutral 9 (white grey) <input type="checkbox"/>	4 552119-18210H² Price gr. A217 (m ²)	552119-12020H² Price gr. A217 (m ²)	552119-18120H Price gr. A121 (m ²)	552119-41550HK² Price gr. A235 (m ²)	552119-12050H² Price gr. A217 (m ²)	552119-42550HK² Price gr. A217 (m ²)
neutral 8 (light-grey) <input type="checkbox"/>	4 552118-18210H Price gr. A187 (m ²)	552118-12020H² Price gr. A217 (m ²)	552118-18120H Price gr. A121 (m ²)	552118-41550HK² Price gr. A235 (m ²)	552118-12050H² Price gr. A217 (m ²)	552118-42550HK² Price gr. A217 (m ²)
neutral 7 (pebble-grey) <input type="checkbox"/>	4 552117-18210H Price gr. A187 (m ²)	552117-12020H² Price gr. A217 (m ²)	552117-18120H Price gr. A121 (m ²)	552117-41550HK² Price gr. A235 (m ²)	552117-12050H Price gr. A187 (m ²)	552117-42550HK² Price gr. A217 (m ²)
neutral 5 (basalt grey) <input type="checkbox"/>	3 552115-18210H² Price gr. A217 (m ²)	552115-12020H² Price gr. A217 (m ²)	552115-18120H² Price gr. A151 (m ²)	552115-41550HK² Price gr. A235 (m ²)	552115-12050H² Price gr. A217 (m ²)	552115-42550HK² Price gr. A217 (m ²)
neutral 3 (asphalt black) <input type="checkbox"/>	3 552113-18210H² Price gr. A217 (m ²)	552113-12020H² Price gr. A217 (m ²)	552113-18120H Price gr. A121 (m ²)	552113-41550HK² Price gr. A235 (m ²)	552113-12050H² Price gr. A217 (m ²)	552113-42550HK² Price gr. A217 (m ²)
neutral 2 (anthracite) <input type="checkbox"/>	2 552112-18210H Price gr. A187 (m ²)	552112-12020H² Price gr. A217 (m ²)	552112-18120H Price gr. A121 (m ²)	552112-41550HK² Price gr. A235 (m ²)	552112-12050H Price gr. A187 (m ²)	552112-42550HK Price gr. A187 (m ²)
neutral 1 (deep black) <input type="checkbox"/>	1 5716i-18210H⁴ Price gr. A187 (m ²)	5716i-12020H⁴ Price gr. A187 (m ²)	5716i-18120H⁴ Price gr. A121 (m ²)	5716-41550HK⁴ Price gr. A208 (m ²)	5716i-12050H⁴ Price gr. A187 (m ²)	5716i-42550HK⁴ Price gr. A187 (m ²)
active azure <input type="checkbox"/>	2 552001-18210H Price gr. A187 (m ²)	552001-12020H Price gr. A187 (m ²)	552001-18120H Price gr. A121 (m ²)	552001-41550HK Price gr. A208 (m ²)	552001-12050H Price gr. A187 (m ²)	552001-42550HK Price gr. A187 (m ²)
light azure <input type="checkbox"/>	4 552002-18210H Price gr. A187 (m ²)	552002-12020H Price gr. A187 (m ²)	552002-18120H Price gr. A121 (m ²)	552002-41550HK Price gr. A208 (m ²)	552002-12050H Price gr. A187 (m ²)	552002-42550HK Price gr. A187 (m ²)
medium azure <input type="checkbox"/>	3 552003-18210H Price gr. A187 (m ²)	552003-12020H Price gr. A187 (m ²)	552003-18120H Price gr. A121 (m ²)	552003-41550HK² Price gr. A235 (m ²)	552003-12050H Price gr. A187 (m ²)	552003-42550HK Price gr. A187 (m ²)
dark azure <input type="checkbox"/>	2 552004-18210H Price gr. A187 (m ²)	552004-12020H Price gr. A187 (m ²)	552004-18120H Price gr. A121 (m ²)	552004-41550HK² Price gr. A235 (m ²)	552004-12050H² Price gr. A217 (m ²)	552004-42550HK² Price gr. A217 (m ²)
active blue <input type="checkbox"/>	2 552005-18210H² Price gr. A217 (m ²)	552005-12020H Price gr. A187 (m ²)	552005-18120H Price gr. A121 (m ²)	552005-41550HK² Price gr. A235 (m ²)	552005-12050H Price gr. A187 (m ²)	552005-42550HK² Price gr. A217 (m ²)
light blue <input type="checkbox"/>	4 552006-18210H² Price gr. A217 (m ²)	552006-12020H Price gr. A187 (m ²)	552006-18120H Price gr. A121 (m ²)	552006-41550HK² Price gr. A235 (m ²)	552006-12050H Price gr. A187 (m ²)	552006-42550HK Price gr. A187 (m ²)
medium blue <input type="checkbox"/>	3 552007-18210H Price gr. A187 (m ²)	552007-12020H Price gr. A187 (m ²)	552007-18120H Price gr. A121 (m ²)	552007-41550HK² Price gr. A235 (m ²)	552007-12050H Price gr. A187 (m ²)	552007-42550HK Price gr. A187 (m ²)
dark blue <input type="checkbox"/>	2 552008-18210H Price gr. A187 (m ²)	552008-12020H² Price gr. A217 (m ²)	552008-18120H Price gr. A121 (m ²)	552008-41550HK² Price gr. A235 (m ²)	552008-12050H² Price gr. A217 (m ²)	552008-42550HK² Price gr. A217 (m ²)
active turquoise <input type="checkbox"/>	2 552009-18210H Price gr. A187 (m ²)	552009-12020H² Price gr. A217 (m ²)	552009-18120H Price gr. A121 (m ²)	552009-41550HK² Price gr. A235 (m ²)	552009-12050H² Price gr. A217 (m ²)	552009-42550HK² Price gr. A217 (m ²)
light turquoise <input type="checkbox"/>	4 552010-18210H Price gr. A187 (m ²)	552010-12020H Price gr. A187 (m ²)	552010-18120H Price gr. A121 (m ²)	552010-41550HK² Price gr. A235 (m ²)	552010-12050H² Price gr. A217 (m ²)	552010-42550HK² Price gr. A217 (m ²)
medium turquoise <input type="checkbox"/>	3 552011-18210H Price gr. A187 (m ²)	552011-12020H Price gr. A187 (m ²)	552011-18120H Price gr. A121 (m ²)	552011-41550HK² Price gr. A235 (m ²)	552011-12050H Price gr. A187 (m ²)	552011-42550HK² Price gr. A217 (m ²)
dark turquoise <input type="checkbox"/>	2 552012-18210H⁴ Price gr. A187 (m ²)	552012-12020H⁴ Price gr. A187 (m ²)	552012-18120H⁴ Price gr. A121 (m ²)	552012-41550HK^{2/4} Price gr. A235 (m ²)	552012-12050H^{2/4} Price gr. A217 (m ²)	552012-42550HK^{2/4} Price gr. A217 (m ²)



³ Overglazed edges / corners, refer to page 147

⁴ Color deviations from the standard due to production reasons are possible.

⁵ Exception neutral 10 (active white glossy): smooth, glossy

⁶ Supplied as double-tiles; to be broken by customer.

Floor/Wall Tiles

6.2 x 25 cm^{3/5}



12.5 x 12.5 cm^{3/5}



12.5 x 25 cm³



12.5 x 50 cm¹

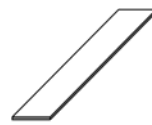

25 x 25 cm³



25 x 50 cm¹

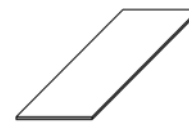

Model number	18210H	12020H	18120H	41550HK	12050H	42550HK	
Nom. dim. - cm/in	6.2 x 25 / 2 1/2 x 10	12.5 x 12.5 / 5 x 5	12.5 x 25 / 5 x 10	12.5 x 50 / 5 x 20	25 x 25 / 10 x 10	25 x 50 / 10 x 20	
Work size	56 x 244 x 6 mm	119 x 119 x 6 mm	119 x 244 x 6 mm	119 x 494 x 8 mm	244 x 244 x 6 mm	244 x 494 x 8 mm	
Surface	smooth, silky-matt	smooth, silky-matt	smooth, silky-matt	smooth, silky-matt	smooth, silky-matt	smooth, silky-matt	
m ² - pieces	64.000	64.000	32.000	16.000	16.000	8.000	
m ² - kg	10.880	12.160	12.160	17.040	12.800	17.040	
Bundle - pieces	88	88	44	8	18	9	
Bundle - m ²	1.375	1.375	1.375	0.500	1.125	1.125	
Bundle - kg	14.960	16.720	16.720	8.520	14.400	19.170	
Pallet - m ²	132.000	115.500	115.500	55.000	91.125	40.500	
Pallet - kg	1,436.160	1,404.480	1,404.480	937.200	1,166.400	690.120	
Product standard	Alb	Alb	Alb	Alb	Alb	Alb	
active green <input type="checkbox"/>	2 552013-18210H Price gr. A187 (m ²)	552013-12020H Price gr. A187 (m ²)	552013-18120H Price gr. A121 (m ²)	552013-41550HK² Price gr. A235 (m ²)	552013-12050H² Price gr. A217 (m ²)	552013-42550HK² Price gr. A217 (m ²)	
light green <input type="checkbox"/>	4 552014-18210H Price gr. A187 (m ²)	552014-12020H Price gr. A187 (m ²)	552014-18120H Price gr. A121 (m ²)	552014-41550HK² Price gr. A235 (m ²)	552014-12050H Price gr. A187 (m ²)	552014-42550HK² Price gr. A217 (m ²)	
medium green <input type="checkbox"/>	3 552015-18210H Price gr. A187 (m ²)	552015-12020H Price gr. A187 (m ²)	552015-18120H Price gr. A121 (m ²)	552015-41550HK² Price gr. A235 (m ²)	552015-12050H Price gr. A187 (m ²)	552015-42550HK Price gr. A187 (m ²)	
dark green <input type="checkbox"/>	2 552016-18210H Price gr. A187 (m ²)	552016-12020H Price gr. A187 (m ²)	552016-18120H Price gr. A121 (m ²)	552016-41550HK² Price gr. A235 (m ²)	552016-12050H Price gr. A187 (m ²)	552016-42550HK² Price gr. A217 (m ²)	
active yellow <input type="checkbox"/>	2 552017-18210H^{2/4} Price gr. A217 (m ²)	552017-12020H^{2/4} Price gr. A217 (m ²)	552017-18120H⁴ Price gr. A121 (m ²)	552017-41550HK^{2/4} Price gr. A235 (m ²)	552017-12050H^{2/4} Price gr. A217 (m ²)	552017-42550HK^{2/4} Price gr. A217 (m ²)	
light yellow <input type="checkbox"/>	4 552018-18210H² Price gr. A217 (m ²)	552018-12020H Price gr. A187 (m ²)	552018-18120H Price gr. A121 (m ²)	552018-41550HK² Price gr. A235 (m ²)	552018-12050H Price gr. A187 (m ²)	552018-42550HK Price gr. A187 (m ²)	
medium yellow <input type="checkbox"/>	3 552019-18210H Price gr. A187 (m ²)	552019-12020H Price gr. A187 (m ²)	552019-18120H Price gr. A121 (m ²)	552019-41550HK² Price gr. A235 (m ²)	552019-12050H Price gr. A187 (m ²)	552019-42550HK² Price gr. A217 (m ²)	
dark yellow <input type="checkbox"/>	2 552020-18210H⁴ Price gr. A187 (m ²)	552020-12020H^{2/4} Price gr. A217 (m ²)	552020-18120H⁴ Price gr. A121 (m ²)	552020-41550HK^{2/4} Price gr. A235 (m ²)	552020-12050H^{2/4} Price gr. A217 (m ²)	552020-42550HK^{2/4} Price gr. A217 (m ²)	
active ochre <input type="checkbox"/>	2 552021-18210H^{2/4} Price gr. A217 (m ²)	552021-12020H^{2/4} Price gr. A217 (m ²)	552021-18120H^{2/4} Price gr. A151 (m ²)	552021-41550HK^{2/4} Price gr. A235 (m ²)	552021-12050H^{2/4} Price gr. A217 (m ²)	552021-42550HK^{2/4} Price gr. A217 (m ²)	
light ochre <input type="checkbox"/>	4 552022-18210H Price gr. A187 (m ²)	552022-12020H² Price gr. A217 (m ²)	552022-18120H² Price gr. A121 (m ²)	552022-41550HK² Price gr. A235 (m ²)	552022-12050H² Price gr. A217 (m ²)	552022-42550HK² Price gr. A217 (m ²)	
medium ochre <input type="checkbox"/>	3 552023-18210H² Price gr. A217 (m ²)	552023-12020H² Price gr. A217 (m ²)	552023-18120H Price gr. A121 (m ²)	552023-41550HK² Price gr. A235 (m ²)	552023-12050H² Price gr. A217 (m ²)	552023-42550HK² Price gr. A217 (m ²)	
dark ochre <input type="checkbox"/>	2 552024-18210H² Price gr. A217 (m ²)	552024-12020H² Price gr. A217 (m ²)	552024-18120H Price gr. A121 (m ²)	552024-41550HK² Price gr. A235 (m ²)	552024-12050H² Price gr. A217 (m ²)	552024-42550HK² Price gr. A217 (m ²)	
active salmon <input type="checkbox"/>	2 552025-18210H⁴ Price gr. A187 (m ²)	552025-12020H^{2/4} Price gr. A217 (m ²)	552025-18120H^{2/4} Price gr. A151 (m ²)	552025-41550HK^{2/4} Price gr. A235 (m ²)	552025-12050H^{2/4} Price gr. A217 (m ²)	552025-42550HK^{2/4} Price gr. A217 (m ²)	
light salmon <input type="checkbox"/>	4 552026-18210H Price gr. A187 (m ²)	552026-12020H² Price gr. A217 (m ²)	552026-18120H Price gr. A121 (m ²)	552026-41550HK² Price gr. A235 (m ²)	552026-12050H² Price gr. A217 (m ²)	552026-42550HK² Price gr. A217 (m ²)	
medium salmon <input type="checkbox"/>	3 552027-18210H Price gr. A187 (m ²)	552027-12020H² Price gr. A217 (m ²)	552027-18120H² Price gr. A151 (m ²)	552027-41550HK² Price gr. A235 (m ²)	552027-12050H Price gr. A187 (m ²)	552027-42550HK² Price gr. A217 (m ²)	
dark salmon <input type="checkbox"/>	2 552028-18210H² Price gr. A217 (m ²)	552028-12020H² Price gr. A217 (m ²)	552028-18120H² Price gr. A151 (m ²)	552028-41550HK² Price gr. A235 (m ²)	552028-12050H² Price gr. A217 (m ²)	552028-42550HK² Price gr. A217 (m ²)	
active oxide red <input type="checkbox"/>	2 552029-18210H Price gr. A187 (m ²)	552029-12020H² Price gr. A217 (m ²)	552029-18120H Price gr. A121 (m ²)	552029-41550HK² Price gr. A235 (m ²)	552029-12050H Price gr. A187 (m ²)	552029-42550HK² Price gr. A217 (m ²)	
light oxide red <input type="checkbox"/>	4 552030-18210H² Price gr. A217 (m ²)	552030-12020H² Price gr. A217 (m ²)	552030-18120H² Price gr. A151 (m ²)	552030-41550HK² Price gr. A235 (m ²)	552030-12050H Price gr. A187 (m ²)	552030-42550HK² Price gr. A217 (m ²)	
medium oxide red <input type="checkbox"/>	3 552031-18210H Price gr. A187 (m ²)	552031-12020H² Price gr. A217 (m ²)	552031-18120H² Price gr. A151 (m ²)	552031-41550HK² Price gr. A235 (m ²)	552031-12050H Price gr. A187 (m ²)	552031-42550HK² Price gr. A217 (m ²)	
dark oxide red <input type="checkbox"/>	2 552032-18210H Price gr. A187 (m ²)	552032-12020H² Price gr. A217 (m ²)	552032-18120H Price gr. A121 (m ²)	552032-41550HK² Price gr. A235 (m ²)	552032-12050H² Price gr. A217 (m ²)	552032-42550HK² Price gr. A217 (m ²)	

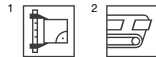

³ Overglazed edges / corners, refer to page 149
⁴ Color deviations from the standard due to production reasons are possible.
⁵ Supplied as double-tiles; to be broken by customer.

Floor/Wall Tiles

6.2 x 25 cm^{3/4}



12.5 x 12.5 cm^{3/4}



12.5 x 25 cm³



12.5 x 50 cm¹

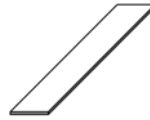

25 x 25 cm³



25 x 50 cm¹

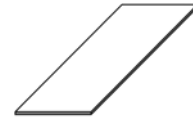

	18210H	12020H	18120H	41550HK	12050H	42550HK	Stress group	Model number
	6.2 x 25 / 2 1/2 x 10	12.5 x 12.5 / 5 x 5	12.5 x 25 / 5 x 10	12.5 x 50 / 5 x 20	25 x 25 / 10 x 10	25 x 50 / 10 x 20		
	56 x 244 x 6 mm	119 x 119 x 6 mm	119 x 244 x 6 mm	119 x 494 x 8 mm	244 x 244 x 6 mm	244 x 494 x 8 mm		Work size
	smooth, silky-matt ⁶	smooth, silky-matt ⁶	smooth, silky-matt ⁶	smooth, silky-matt ⁶	smooth, silky-matt ⁶	smooth, silky-matt ⁶		Surface
	64.000	64.000	32.000	16.000	16.000	8.000		m ² - pieces
	10.880	12.160	12.160	17.040	12.800	17.040		m ² - kg
	88	88	44	8	18	9		Bundle - pieces
	1.375	1.375	1.375	0.500	1.125	1.125		Bundle - m ²
	14.960	16.720	16.720	8.520	14.400	19.170		Bundle - kg
	132.000	115.500	115.500	55.000	91.125	40.500		Pallet - m ²
	1,436.160	1,404.480	1,404.480	937.200	1,166.400	690.120		Pallet - kg
	Alb	Alb	Alb	Alb	Alb	Alb		Product standard
	552033-18210H	552033-12020H²	552033-18120H	552033-41550HK²	552033-12050H²	552033-42550HK²	2	active stone grey <input type="checkbox"/> VO
	Price gr. A187 (m ²)	Price gr. A217 (m ²)	Price gr. A121 (m ²)	Price gr. A235 (m ²)	Price gr. A217 (m ²)	Price gr. A217 (m ²)		
	552034-18210H²	552034-12020H²	552034-18120H²	552034-41550HK²	552034-12050H²	552034-42550HK²	4	light stone grey <input type="checkbox"/> VO
	Price gr. A217 (m ²)	Price gr. A217 (m ²)	Price gr. A151 (m ²)	Price gr. A235 (m ²)	Price gr. A217 (m ²)	Price gr. A217 (m ²)		
	552035-18210H	552035-12020H	552035-18120H	552035-41550HK²	552035-12050H²	552035-42550HK²	3	medium stone grey <input type="checkbox"/> VO
	Price gr. A187 (m ²)	Price gr. A187 (m ²)	Price gr. A121 (m ²)	Price gr. A235 (m ²)	Price gr. A217 (m ²)	Price gr. A217 (m ²)		
	552036-18210H²	552036-12020H²	552036-18120H	552036-41550HK²	552036-12050H²	552036-42550HK²	2	dark stone grey <input type="checkbox"/> VO
	Price gr. A217 (m ²)	Price gr. A217 (m ²)	Price gr. A121 (m ²)	Price gr. A235 (m ²)	Price gr. A217 (m ²)	Price gr. A217 (m ²)		
	552037-18210H²	552037-12020H²	552037-18120H	552037-41550HK²	552037-12050H²	552037-42550HK²	2	active sand-grey <input type="checkbox"/> VO
	Price gr. A217 (m ²)	Price gr. A217 (m ²)	Price gr. A121 (m ²)	Price gr. A235 (m ²)	Price gr. A217 (m ²)	Price gr. A217 (m ²)		
	552038-18210H	552038-12020H	552038-18120H	552038-41550HK²	552038-12050H	552038-42550HK²	4	light sand-grey <input type="checkbox"/> VO
	Price gr. A187 (m ²)	Price gr. A187 (m ²)	Price gr. A121 (m ²)	Price gr. A235 (m ²)	Price gr. A187 (m ²)	Price gr. A217 (m ²)		
	552039-18210H²	552039-12020H²	552039-18120H	552039-41550HK²	552039-12050H²	552039-42550HK²	3	medium sand-grey <input type="checkbox"/> VO
	Price gr. A217 (m ²)	Price gr. A217 (m ²)	Price gr. A121 (m ²)	Price gr. A235 (m ²)	Price gr. A217 (m ²)	Price gr. A217 (m ²)		
	552040-18210H²	552040-12020H²	552040-18120H	552040-41550HK²	552040-12050H²	552040-42550HK	2	dark sand-grey <input type="checkbox"/> VO
	Price gr. A217 (m ²)	Price gr. A217 (m ²)	Price gr. A121 (m ²)	Price gr. A235 (m ²)	Price gr. A217 (m ²)	Price gr. A187 (m ²)		
	717i-18210H²	717i-12020H²	717i-18120H²	717i-41550HK²	717i-12050H²	717i-42550HK²	1	black glossy <input type="checkbox"/> VO
	Price gr. A217 (m ²)	Price gr. A217 (m ²)	Price gr. A151 (m ²)	Price gr. A235 (m ²)	Price gr. A217 (m ²)	Price gr. A217 (m ²)		
	151i-18210H²	151i-12020H²	151i-18120H²	151i-41550HK²	151i-12050H²	151i-42550HK²	1	orange glossy <input type="checkbox"/> VO
	Price gr. A217 (m ²)	Price gr. A217 (m ²)	Price gr. A151 (m ²)	Price gr. A235 (m ²)	Price gr. A217 (m ²)	Price gr. A217 (m ²)		
	150i-18210H²	150i-12020H²	150i-18120H²	150i-41550HK²	150i-12050H²	150i-42550HK²	2	lemon-yellow glossy <input type="checkbox"/> VO
	Price gr. A217 (m ²)	Price gr. A217 (m ²)	Price gr. A151 (m ²)	Price gr. A235 (m ²)	Price gr. A217 (m ²)	Price gr. A217 (m ²)		
	154i-18210H²	154i-12020H²	154i-18120H²	154i-41550HK²	154i-12050H²	154i-42550HK²	1	contrasting red glossy <input type="checkbox"/> VO
	Price gr. A217 (m ²)	Price gr. A217 (m ²)	Price gr. A151 (m ²)	Price gr. A235 (m ²)	Price gr. A217 (m ²)	Price gr. A217 (m ²)		
	144-18210^{2/5}	144-12020^{2/5}	144-18120^{2/5}	144-41550K^{2/5}	144-12050^{2/5}	144-42550K^{2/5}	1	intense blue glossy <input type="checkbox"/> VO
	Price gr. A217 (m ²)	Price gr. A217 (m ²)	Price gr. A151 (m ²)	Price gr. A235 (m ²)	Price gr. A217 (m ²)	Price gr. A217 (m ²)		
	152i-18210H²	152i-12020H²	152i-18120H²	152i-41550HK²	152i-12050H²	152i-42550HK²	2	apple-green glossy <input type="checkbox"/> VO
	Price gr. A217 (m ²)	Price gr. A217 (m ²)	Price gr. A151 (m ²)	Price gr. A235 (m ²)	Price gr. A217 (m ²)	Price gr. A217 (m ²)		
	153i-18210H²	153i-12020H²	153i-18120H²	153i-41550HK²	153i-12050H²	153i-42550HK²	1	violet glossy <input type="checkbox"/> VO
	Price gr. A217 (m ²)	Price gr. A217 (m ²)	Price gr. A151 (m ²)	Price gr. A235 (m ²)	Price gr. A217 (m ²)	Price gr. A217 (m ²)		

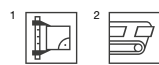

³ Overglazed edges / corners, see below

⁴ Supplied as double-tiles; to be broken by customer.

⁵ without Hytect coating

⁶ Exception: contrasting colors black, orange, lemon-yellow, contrasting red, intense blue, apple-green, violet: smooth, glossy



Overglazed edges available on request:		
	... 3 = corner left	... 4 = corner right

overglazed edges

Example: Standard model no. 18120 = 119 x 244 x 6 mm,
model no. 18123 = overglazed corner left



Solebad, Werne, Germany / Architect: Geising + Böker GmbH, Büro Vechta
Photo: Jochen Stüber





Slip resistance "B"

-/B



91 white / neutral 10 (active white)



553119 neutral 9 (white-grey)



553118 neutral 8 (light-grey)



553117 neutral 7 (pebble-grey)



553115 neutral 5 (basalt-grey)



553113 neutral 3 (asphalt black)



553112 neutral 2 (anthracite)

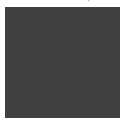

340 black / neutral 1 (deep black)

-/B



553004 dark azure



553008 dark blue



553016 dark green



553036 dark stone grey



553040 dark sand-grey



553003 medium azure



553007 medium blue



553011 medium turquoise



553015 medium green



553019 medium yellow



553023 medium ochre



553027 medium salmon



553031 medium oxid red



553035 medium stone grey



553039 medium sand-grey



553002 light azure



553006 light blue

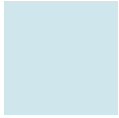

553010 light turquoise



553014 light green



553018 light yellow



553026 light salmon



553034 light stone grey

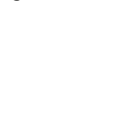

553038 light sand-grey

-/B



553001 active azure



553033 active stone grey



553037 active sand-grey

-/B



77 contrasting red



Floor tile
12.5 x 12.5 cm, 5 x 5 in,
smooth, -/B



Floor tile
12.5 x 25 cm, 5 x 10 in,
smooth, -/B



Floor tile
25 x 25 cm, 10 x 10 in,
smooth, -/B



Slip resistance „B“

Floor Tiles²

12.5 x 12.5 cm³



12.5 x 25 cm



25 x 25 cm



	32020H	38110H	32050H	Model number
	12.5 x 12.5 / 5 x 5	12.5 x 25 / 5 x 10	25 x 25 / 10 x 10	Nom. dim. - cm/in
	119 x 119 x 8 mm	119 x 244 x 8 mm	244 x 244 x 8 mm	Work size
	smooth, silky-matt	smooth, silky-matt	smooth, silky-matt	Surface
	64.000	32.000	16.000	m ² - pieces
	15.360	15.680	16.960	m ² - kg
	66	33	14	Bundle - pieces
	1.031	1.031	0.875	Bundle - m ²
	15.840	16.170	14.840	Bundle - kg
	86.625	86.625	70.875	Pallet - m ²
	1,330.560	1,358.280	1,202.040	Pallet - kg
	Alb	Alb	Alb	Product standard
	-/B	-/B	-/B	Slip resistance
	2	2	2	Stress group
	91i-32020H	91i-38110H	91i-32050H	neutral 10
	Price gr. A217 (m ²)	Price gr. A199 (m ²)	Price gr. A217 (m ²)	(active white) <input type="checkbox"/>
	340i-32020H	340i-38110H	340i-32050H	neutral 1
	Price gr. A217 (m ²)	Price gr. A199 (m ²)	Price gr. A217 (m ²)	(deep black) <input type="checkbox"/>
	553001-32020H	553001-38110H	553001-32050H	active azure <input type="checkbox"/>
	Price gr. A217 (m ²)	Price gr. A199 (m ²)	Price gr. A217 (m ²)	
	553002-32020H	553002-38110H	553002-32050H	light azure <input type="checkbox"/>
	Price gr. A217 (m ²)	Price gr. A199 (m ²)	Price gr. A217 (m ²)	
	553003-32020H	553003-38110H	553003-32050H	medium azure <input type="checkbox"/>
	Price gr. A217 (m ²)	Price gr. A199 (m ²)	Price gr. A217 (m ²)	
	553004-32020H	553004-38110H	553004-32050H	dark azure <input type="checkbox"/>
	Price gr. A217 (m ²)	Price gr. A199 (m ²)	Price gr. A217 (m ²)	
	553006-32020H	553006-38110H	553006-32050H	light blue <input type="checkbox"/>
	Price gr. A217 (m ²)	Price gr. A199 (m ²)	Price gr. A217 (m ²)	
	553007-32020H	553007-38110H	553007-32050H	medium blue <input type="checkbox"/>
	Price gr. A217 (m ²)	Price gr. A199 (m ²)	Price gr. A217 (m ²)	
	553008-32020H	553008-38110H¹	553008-32050H¹	dark blue <input type="checkbox"/>
	Price gr. A217 (m ²)	Price gr. A199 (m ²)	Price gr. A217 (m ²)	
	553010-32020H	553010-38110H	553010-32050H¹	light turquoise <input type="checkbox"/>
	Price gr. A217 (m ²)	Price gr. A199 (m ²)	Price gr. A217 (m ²)	
	553011-32020H	553011-38110H	553011-32050H	medium turquoise <input type="checkbox"/>
	Price gr. A217 (m ²)	Price gr. A199 (m ²)	Price gr. A217 (m ²)	
	553014-32020H	553014-38110H¹	553014-32050H¹	light green <input type="checkbox"/>
	Price gr. A217 (m ²)	Price gr. A199 (m ²)	Price gr. A217 (m ²)	
	553015-32020H	553015-38110H	553015-32050H	medium green <input type="checkbox"/>
	Price gr. A217 (m ²)	Price gr. A199 (m ²)	Price gr. A217 (m ²)	
	553016-32020H	553016-38110H	553016-32050H	dark green <input type="checkbox"/>
	Price gr. A217 (m ²)	Price gr. A199 (m ²)	Price gr. A217 (m ²)	
	553018-32020H¹	553018-38110H¹	553018-32050H¹	light yellow <input type="checkbox"/>
	Price gr. A217 (m ²)	Price gr. A199 (m ²)	Price gr. A217 (m ²)	
	553019-32020H	553019-38110H	553019-32050H	medium yellow <input type="checkbox"/>
	Price gr. A217 (m ²)	Price gr. A199 (m ²)	Price gr. A217 (m ²)	
	553023-32020H¹	553023-38110H	553023-32050H	medium ochre <input type="checkbox"/>
	Price gr. A217 (m ²)	Price gr. A199 (m ²)	Price gr. A217 (m ²)	
	553026-32020H¹	553026-38110H¹	553026-32050H¹	light salmon <input type="checkbox"/>
	Price gr. A217 (m ²)	Price gr. A199 (m ²)	Price gr. A217 (m ²)	
	553027-32020H¹	553027-38110H	553027-32050H	medium salmon <input type="checkbox"/>
	Price gr. A217 (m ²)	Price gr. A199 (m ²)	Price gr. A217 (m ²)	
	553031-32020H	553031-38110H¹	553031-32050H¹	medium oxide red <input type="checkbox"/>
	Price gr. A217 (m ²)	Price gr. A199 (m ²)	Price gr. A217 (m ²)	
	553033-32020H¹	553033-38110H¹	553033-32050H¹	active stone grey <input type="checkbox"/>
	Price gr. A217 (m ²)	Price gr. A199 (m ²)	Price gr. A217 (m ²)	
	553034-32020H	553034-38110H¹	553034-32050H¹	light stone grey <input type="checkbox"/>
	Price gr. A217 (m ²)	Price gr. A199 (m ²)	Price gr. A217 (m ²)	
	553035-32020H	553035-38110H	553035-32050H¹	medium stone grey <input type="checkbox"/>
	Price gr. A217 (m ²)	Price gr. A199 (m ²)	Price gr. A217 (m ²)	
	553036-32020H	553036-38110H	553036-32050H¹	dark stone grey <input type="checkbox"/>
	Price gr. A217 (m ²)	Price gr. A199 (m ²)	Price gr. A217 (m ²)	



² Rounded edges / corners refer to page 155

³ Supplied as double-tiles; to be broken by customer.

Slip resistance „B“

Floor Tiles²

12.5 x 12.5 cm³



12.5 x 25 cm



25 x 25 cm



Model number	32020H	38110H	32050H			
Nom. dim. - cm/in	12.5 x 12.5 / 5 x 5	12.5 x 25 / 5 x 10	25 x 25 / 10 x 10			
Work size	119 x 119 x 8 mm	119 x 244 x 8 mm	244 x 244 x 8 mm			
Surface	smooth, silky-matt	smooth, silky-matt	smooth, silky-matt			
m ² - pieces	64.000	32.000	16.000			
m ² - kg	15.360	15.680	16.960			
Bundle - pieces	66	33	14			
Bundle - m ²	1.031	1.031	0.875			
Bundle - kg	15.840	16.170	14.840			
Pallet - m ²	86.625	86.625	70.875			
Pallet - kg	1,330.500	1,358.280	1,202.040			
Product standard	Alb	Alb	Alb			
Slip resistance	-/B	-/B	-/B			
Stress group	2	2	2			
	553037-32020H ¹ Price gr. A217 (m ²)	553037-38110H ¹ Price gr. A199 (m ²)	553037-32050H ¹ Price gr. A217 (m ²)			
active sand-grey	553038-32020H Price gr. A217 (m ²)	553038-38110H Price gr. A199 (m ²)	553038-32050H ¹ Price gr. A217 (m ²)			
light sand-grey	553039-32020H Price gr. A217 (m ²)	553039-38110H ¹ Price gr. A199 (m ²)	553039-32050H ¹ Price gr. A217 (m ²)			
medium sand-grey	553040-32020H Price gr. A217 (m ²)	553040-38110H ¹ Price gr. A199 (m ²)	553040-32050H ¹ Price gr. A217 (m ²)			
dark sand-grey	553119-32020H ¹ Price gr. A217 (m ²)	553119-38110H ¹ Price gr. A199 (m ²)	553119-32050H Price gr. A217 (m ²)			
neutral 9 (white grey)	553118-32020H Price gr. A217 (m ²)	553118-38110H ¹ Price gr. A199 (m ²)	553118-32050H Price gr. A217 (m ²)			
neutral 8 (light-grey)	553117-32020H Price gr. A217 (m ²)	553117-38110H Price gr. A199 (m ²)	553117-32050H Price gr. A217 (m ²)			
neutral 7 (pebble-grey)	553115-32020H ¹ Price gr. A217 (m ²)	553115-38110H ¹ Price gr. A199 (m ²)	553115-32050H ¹ Price gr. A217 (m ²)			
neutral 5 (basalt grey)	553113-32020H Price gr. A217 (m ²)	553113-38110H Price gr. A199 (m ²)	553113-32050H Price gr. A217 (m ²)			
neutral 3 (asphalt black)	553112-32020H Price gr. A217 (m ²)	553112-38110H Price gr. A199 (m ²)	553112-32050H Price gr. A217 (m ²)			
neutral 2 (anthracite)	77i-32020H Price gr. A217 (m ²)	77i-38110H Price gr. A199 (m ²)	77i-32050H Price gr. A217 (m ²)			
contrasting red						



² Rounded edges / corners refer to page 155

³ Supplied as double-tiles; to be broken by customer.

Slip resistance „B“ – rounded edges/corners^{1/2}

Floor Tiles



	<i>rounded edge</i>	<i>rounded corner</i>	<i>short side rounded</i>	<i>long side rounded</i>	<i>rounded corner left</i>	<i>rounded corner right</i>	
	32025H	32027H	38115H	38116H	38117H	38118H	Model number
	12.5 x 12.5 / 5 x 5	12.5 x 12.5 / 5 x 5	12.5 x 25 / 5 x 10	12.5 x 25 / 5 x 10	12.5 x 25 / 5 x 10	12.5 x 25 / 5 x 10	Nom. dim. - cm/in
	119 x 119 x 8 mm	119 x 119 x 8 mm	119 x 244 x 8 mm	119 x 244 x 8 mm	119 x 244 x 8 mm	119 x 244 x 8 mm	Work size
	smooth, silky-matt	smooth, silky-matt	smooth, silky-matt	smooth, silky-matt	smooth, silky-matt	smooth, silky-matt	Surface
	0.240	0.240	0.490	0.490	0.490	0.490	m ² - pieces
	66	66	33	33	33	33	m ² - kg
	15.840	15.840	16.170	16.170	16.170	16.170	Bundle - pieces
	Alb	Alb	Alb	Alb	Alb	Alb	Bundle - m ²
	-/B ☒	-/B ☒	-/B ☒	-/B ☒	-/B ☒	-/B ☒	Bundle - kg
	2	2	2	2	2	2	Pallet - m ²
	<i>91i-32025H</i>	<i>91i-32027H</i>	<i>91i-38115H</i>	<i>91i-38116H</i>	<i>91i-38117H</i>	<i>91i-38118H</i>	Pallet - kg
	<i>Price gr. A410 (pce.)</i>	<i>Price gr. A410 (pce.)</i>	<i>Price gr. A416 (pce.)</i>	<i>Price gr. A416 (pce.)</i>	<i>Price gr. A416 (pce.)</i>	<i>Price gr. A416 (pce.)</i>	Product standard
	<i>340i-32025H</i>	<i>340i-32027H</i>	<i>340i-38115H</i>	<i>340i-38116H</i>	<i>340i-38117H</i>	<i>340i-38118H</i>	Slip resistance
	<i>Price gr. A410 (pce.)</i>	<i>Price gr. A410 (pce.)</i>	<i>Price gr. A416 (pce.)</i>	<i>Price gr. A416 (pce.)</i>	<i>Price gr. A416 (pce.)</i>	<i>Price gr. A416 (pce.)</i>	Stress group
	<i>553001-32025H</i>	<i>553001-32027H</i>	<i>553001-38115H</i>	<i>553001-38116H</i>	<i>553001-38117H</i>	<i>553001-38118H</i>	neutral 10
	<i>Price gr. A410 (pce.)</i>	<i>Price gr. A410 (pce.)</i>	<i>Price gr. A416 (pce.)</i>	<i>Price gr. A416 (pce.)</i>	<i>Price gr. A416 (pce.)</i>	<i>Price gr. A416 (pce.)</i>	(active white) <input type="checkbox"/> VO
	<i>553002-32025H</i>	<i>553002-32027H</i>	<i>553002-38115H</i>	<i>553002-38116H</i>	<i>553002-38117H</i>	<i>553002-38118H</i>	neutral 1
	<i>Price gr. A410 (pce.)</i>	<i>Price gr. A410 (pce.)</i>	<i>Price gr. A416 (pce.)</i>	<i>Price gr. A416 (pce.)</i>	<i>Price gr. A416 (pce.)</i>	<i>Price gr. A416 (pce.)</i>	(deep black) <input type="checkbox"/> VO
							active azure <input type="checkbox"/> VO
							light azure <input type="checkbox"/> VO



Floor Tiles



	<i>rounded edge</i>	<i>rounded corner</i>	
	32055H	32057H	Model number
	25 x 25 / 10 x 10	25 x 25 / 10 x 10	Nom. dim. - cm/in
	244 x 244 x 8 mm	244 x 244 x 8 mm	Work size
	smooth, silky-matt	smooth, silky-matt	Surface
	1.060	1.060	m ² - pieces
	14	14	m ² - kg
	14.840	14.840	Bundle - pieces
	Alb	Alb	Bundle - m ²
	-/B ☒	-/B ☒	Bundle - kg
	2	2	Pallet - m ²
	<i>91i-32055H</i>	<i>91i-32057H</i>	Pallet - kg
	<i>Price gr. A434 (pce.)</i>	<i>Price gr. A434 (pce.)</i>	Product standard
	<i>340i-32055H</i>	<i>340i-32057H</i>	Slip resistance
	<i>Price gr. A434 (pce.)</i>	<i>Price gr. A434 (pce.)</i>	Stress group
	<i>553001-32055H</i>	<i>553001-32057H</i>	neutral 10
	<i>Price gr. A434 (pce.)</i>	<i>Price gr. A434 (pce.)</i>	(active white) <input type="checkbox"/> VO
	<i>553002-32055H</i>	<i>553002-32057H</i>	neutral 1
	<i>Price gr. A434 (pce.)</i>	<i>Price gr. A434 (pce.)</i>	(deep black) <input type="checkbox"/> VO
			active azure <input type="checkbox"/> VO
			light azure <input type="checkbox"/> VO

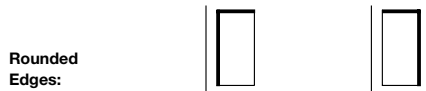
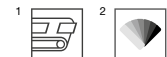

Rounded Edges:

Replace last figure 0 of Standard model no. by 7 = corner left	... 8 = corner right	overglazed edges	Example: Standard model no. 38110 = 119 x 244 x 6 mm, model no. 38117 = rounded corner left
--	---------------------	----------------------	------------------	---

Slip resistance "C"

-/C



81 white / neutral 10 (active white)



554119 neutral 9 (white-grey)



554118 neutral 8 (light-grey)



554117 neutral 7 (pebble-grey)



554113 neutral 3 (asphalt black)



554111 black / neutral 1 (deep black)

-/C



554004 dark azure



554008 dark blue



554016 dark green



554036 dark stone grey



554040 dark sand-grey



554003 medium azure



554007 medium blue



554011 medium turquoise



554015 medium green



554019 medium yellow



554023 medium ochre



554027 medium salmon



554031 medium oxid red



554035 medium stone grey



554039 medium sand-grey



554002 light azure

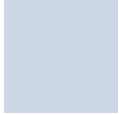

554006 light blue

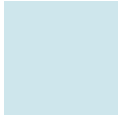

554010 light turquoise



554014 light green



554026 light salmon

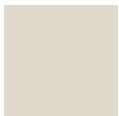

554038 light sand-grey

-/C



554001 active azure

-/C



78 contrasting red



Floor tile
12.5 x 12.5 cm, 5 x 5 in,
structured, -/C



Floor tile
12.5 x 25 cm, 5 x 10 in,
structured, -/C



Floor tile
25 x 25 cm, 10 x 10 in,
structured, -/C

On request, other colors of the series Chroma are also available as non-slip glazes with a joint width of 6 mm.

Slip resistance „C“
Floor Tiles²

12.5 x 12.5 cm³



12.5 x 25 cm



25 x 25 cm



				32020H	38110H	32050H	Model number
				12.5 x 12.5 / 5 x 5	12.5 x 25 / 5 x 10	25 x 25 / 10 x 10	Nom. dim. - cm/in
				119 x 119 x 8 mm	119 x 244 x 8 mm	244 x 244 x 8 mm	Work size
				structured, silky-matt	structured, silky-matt	structured, silky-matt	Surface
				64.000	32.000	16.000	m ² - pieces
				15.360	15.680	16.960	m ² - kg
				66	33	14	Bundle - pieces
				1.031	1.031	0.875	Bundle - m ²
				15.840	16.170	14.840	Bundle - kg
				86.625	86.625	70.875	Pallet - m ²
				1,330.560	1,358.280	1,202.040	Pallet - kg
				Alb	Alb	Alb	Product standard
				-/C	-/C	-/C	Slip resistance
				2	2	2	Stress group
				81i-32020H	81i-38110H	81i-32050H	neutral 10
				Price gr. A217 (m ²)	Price gr. A199 (m ²)	Price gr. A217 (m ²)	(active white) <input type="checkbox"/>
				554111-32020H	554111-38110H	554111-32050H¹	neutral 1
				Price gr. A217 (m ²)	Price gr. A199 (m ²)	Price gr. A217 (m ²)	(deep black) <input type="checkbox"/>
				554001-32020H	554001-38110H	554001-32050H¹	active azure <input type="checkbox"/>
				Price gr. A217 (m ²)	Price gr. A199 (m ²)	Price gr. A217 (m ²)	
				554002-32020H	554002-38110H	554002-32050H	light azure <input type="checkbox"/>
				Price gr. A217 (m ²)	Price gr. A199 (m ²)	Price gr. A217 (m ²)	
				554003-32020H	554003-38110H	554003-32050H	medium azure <input type="checkbox"/>
				Price gr. A217 (m ²)	Price gr. A199 (m ²)	Price gr. A217 (m ²)	
				554004-32020H	554004-38110H	554004-32050H¹	dark azure <input type="checkbox"/>
				Price gr. A217 (m ²)	Price gr. A199 (m ²)	Price gr. A217 (m ²)	
				554006-32020H	554006-38110H	554006-32050H¹	light blue <input type="checkbox"/>
				Price gr. A217 (m ²)	Price gr. A199 (m ²)	Price gr. A217 (m ²)	
				554007-32020H	554007-38110H	554007-32050H¹	medium blue <input type="checkbox"/>
				Price gr. A217 (m ²)	Price gr. A199 (m ²)	Price gr. A217 (m ²)	
				554008-32020H	554008-38110H	554008-32050H¹	dark blue <input type="checkbox"/>
				Price gr. A217 (m ²)	Price gr. A199 (m ²)	Price gr. A217 (m ²)	
				554010-32020H	554010-38110H	554010-32050H¹	light turquoise <input type="checkbox"/>
				Price gr. A217 (m ²)	Price gr. A199 (m ²)	Price gr. A217 (m ²)	
				554011-32020H	554011-38110H	554011-32050H¹	medium turquoise <input type="checkbox"/>
				Price gr. A217 (m ²)	Price gr. A199 (m ²)	Price gr. A217 (m ²)	
				554014-32020H	554014-38110H¹	554014-32050H¹	light green <input type="checkbox"/>
				Price gr. A217 (m ²)	Price gr. A199 (m ²)	Price gr. A217 (m ²)	
				554015-32020H	554015-38110H¹	554015-32050H¹	medium green <input type="checkbox"/>
				Price gr. A217 (m ²)	Price gr. A199 (m ²)	Price gr. A217 (m ²)	
				554016-32020H	554016-38110H	554016-32050H	dark green <input type="checkbox"/>
				Price gr. A217 (m ²)	Price gr. A199 (m ²)	Price gr. A217 (m ²)	
				554019-32020H	554019-38110H	554019-32050H¹	medium yellow <input type="checkbox"/>
				Price gr. A217 (m ²)	Price gr. A199 (m ²)	Price gr. A217 (m ²)	
				554023-32020H	554023-38110H	554023-32050H	medium ochre <input type="checkbox"/>
				Price gr. A217 (m ²)	Price gr. A199 (m ²)	Price gr. A217 (m ²)	
				554026-32020H¹	554026-38110H¹	554026-32050H¹	light salmon <input type="checkbox"/>
				Price gr. A217 (m ²)	Price gr. A199 (m ²)	Price gr. A217 (m ²)	
				554027-32020H	554027-38110H	554027-32050H¹	medium salmon <input type="checkbox"/>
				Price gr. A217 (m ²)	Price gr. A199 (m ²)	Price gr. A217 (m ²)	
				554031-32020H	554031-38110H	554031-32050H¹	medium oxide red <input type="checkbox"/>
				Price gr. A217 (m ²)	Price gr. A199 (m ²)	Price gr. A217 (m ²)	
				554035-32020H	554035-38110H	554035-32050H¹	medium stone grey <input type="checkbox"/>
				Price gr. A217 (m ²)	Price gr. A199 (m ²)	Price gr. A217 (m ²)	
				554036-32020H	554036-38110H	554036-32050H¹	dark stone grey <input type="checkbox"/>
				Price gr. A217 (m ²)	Price gr. A199 (m ²)	Price gr. A217 (m ²)	
				554038-32020H	554038-38110H	554038-32050H	light sand-grey <input type="checkbox"/>
				Price gr. A217 (m ²)	Price gr. A199 (m ²)	Price gr. A217 (m ²)	
				554039-32020H	554039-38110H	554039-32050H¹	medium sand-grey <input type="checkbox"/>
				Price gr. A217 (m ²)	Price gr. A199 (m ²)	Price gr. A217 (m ²)	
				554040-32020H	554040-38110H	554040-32050H¹	dark sand-grey <input type="checkbox"/>
				Price gr. A217 (m ²)	Price gr. A199 (m ²)	Price gr. A217 (m ²)	
				554119-32020H¹	554119-38110H	554119-32050H¹	neutral 9
				Price gr. A217 (m ²)	Price gr. A199 (m ²)	Price gr. A217 (m ²)	(white grey) <input type="checkbox"/>
				554118-32020H	554118-38110H	554118-32050H¹	neutral 8
				Price gr. A217 (m ²)	Price gr. A199 (m ²)	Price gr. A217 (m ²)	(light-grey) <input type="checkbox"/>
				554117-32020H	554117-38110H	554117-32050H	neutral 7
				Price gr. A217 (m ²)	Price gr. A199 (m ²)	Price gr. A217 (m ²)	(pebble-grey) <input type="checkbox"/>
				554113-32020H	554113-38110H	554113-32050H	neutral 3
				Price gr. A217 (m ²)	Price gr. A199 (m ²)	Price gr. A217 (m ²)	(asphalt black) <input type="checkbox"/>
				78i-32020H	78i-38110H	78i-32050H¹	contrasting red <input type="checkbox"/>
				Price gr. A217 (m ²)	Price gr. A199 (m ²)	Price gr. A217 (m ²)	



¹ Rounded edges / corners refer to page 158

² Supplied as double-tiles; to be broken by customer.



Slip resistance „C“ – rounded edges/corners^{1/2}

Floor Tiles



	<i>rounded edge</i>	<i>rounded corner</i>	<i>short side rounded</i>	<i>long side rounded</i>	<i>rounded corner left</i>	<i>rounded corner right</i>
Model number	32025H	32027H	38115H	38116H	38117H	38118H
Nom. dim. - cm/in	12.5 x 12.5 / 5 x 5	12.5 x 12.5 / 5 x 5	12.5 x 25 / 5 x 10	12.5 x 25 / 5 x 10	12.5 x 25 / 5 x 10	12.5 x 25 / 5 x 10
Work size	119 x 119 x 8 mm	119 x 119 x 8 mm	119 x 244 x 8 mm	119 x 244 x 8 mm	119 x 244 x 8 mm	119 x 244 x 8 mm
Surface	structured, silky-matt	structured, silky-matt	structured, silky-matt	structured, silky-matt	structured, silky-matt	structured, silky-matt
m ² - pieces						
m ² - kg	0.240	0.240	0.490	0.490	0.490	0.490
Bundle - pieces	66	66	33	33	33	33
Bundle - m ²						
Bundle - kg	15.840	15.840	16.170	16.170	16.170	16.170
Pallet - m ²						
Pallet - kg						
Product standard	Alb	Alb	Alb	Alb	Alb	Alb
Slip resistance	-/C	-/C	-/C	-/C	-/C	-/C
Stress group	2	2	2	2	2	2
neutral 10	<i>81i-32025H</i>	<i>81i-32027H</i>	<i>81i-38115H</i>	<i>81i-38116H</i>	<i>81i-38117H</i>	<i>81i-38118H</i>
(active white)	<i>Price gr. A410 (pce.)</i>	<i>Price gr. A410 (pce.)</i>	<i>Price gr. A416 (pce.)</i>	<i>Price gr. A416 (pce.)</i>	<i>Price gr. A416 (pce.)</i>	<i>Price gr. A416 (pce.)</i>
neutral 1	<i>554111-32025H</i>	<i>554111-32027H</i>	<i>554111-38115H</i>	<i>554111-38116H</i>	<i>554111-38117H</i>	<i>554111-38118H</i>
(deep black)	<i>Price gr. A410 (pce.)</i>	<i>Price gr. A410 (pce.)</i>	<i>Price gr. A416 (pce.)</i>	<i>Price gr. A416 (pce.)</i>	<i>Price gr. A416 (pce.)</i>	<i>Price gr. A416 (pce.)</i>
active azure	<i>554001-32025H</i>	<i>554001-32027H</i>	<i>554001-38115H</i>	<i>554001-38116H</i>	<i>554001-38117H</i>	<i>554001-38118H</i>
	<i>Price gr. A410 (pce.)</i>	<i>Price gr. A410 (pce.)</i>	<i>Price gr. A416 (pce.)</i>	<i>Price gr. A416 (pce.)</i>	<i>Price gr. A416 (pce.)</i>	<i>Price gr. A416 (pce.)</i>
light azure	<i>554002-32025H</i>	<i>554002-32027H</i>	<i>554002-38115H</i>	<i>554002-38116H</i>	<i>554002-38117H</i>	<i>554002-38118H</i>
	<i>Price gr. A410 (pce.)</i>	<i>Price gr. A410 (pce.)</i>	<i>Price gr. A416 (pce.)</i>	<i>Price gr. A416 (pce.)</i>	<i>Price gr. A416 (pce.)</i>	<i>Price gr. A416 (pce.)</i>



	<i>rounded edge</i>	<i>rounded corner</i>
Model number	32055H	32057H
Nom. dim. - cm/in	25 x 25 / 10 x 10	25 x 25 / 10 x 10
Work size	244 x 244 x 8 mm	244 x 244 x 8 mm
Surface	structured, silky-matt	structured, silky-matt
m ² - pieces		
m ² - kg	1.060	1.060
Bundle - pieces	14	14
Bundle - m ²		
Bundle - kg	14.840	14.840
Pallet - m ²		
Pallet - kg		
Product standard	Alb	Alb
Slip resistance	-/C	-/C
Stress group	2	2
neutral 10	<i>81i-32055H</i>	<i>81i-32057H</i>
(active white)	<i>Price gr. A434 (pce.)</i>	<i>Price gr. A434 (pce.)</i>
neutral 1	<i>554111-32055H</i>	<i>554111-32057H</i>
(deep black)	<i>Price gr. A434 (pce.)</i>	<i>Price gr. A434 (pce.)</i>
active azure	<i>554001-32055H</i>	<i>554001-32057H</i>
	<i>Price gr. A434 (pce.)</i>	<i>Price gr. A434 (pce.)</i>
light azure	<i>554002-32055H</i>	<i>554002-32057H</i>
	<i>Price gr. A434 (pce.)</i>	<i>Price gr. A434 (pce.)</i>



Rounded Edges:



Replace last figure 0 of Standard model no. by ...

... 7 = corner left

... 8 = corner right

overglazed edges

Example: Standard model no. 38110 = 119 x 244 x 6 mm, model no. 38117 = rounded corner left



Oasia Hotel, Singapore / Architect: WOHA Architects + Patricia Urquiola / Series: Chroma non-slip, Chroma / Photo: Infitude









Quantum



926
white / neutral 10 (active white)



555118
neutral 8 (light-grey)



555117
neutral 7 (pebble-grey)



555113
neutral 3 (asphalt black)



918
black / neutral 1 (deep black)



901
natural-white



555036
dark stone grey



555040
dark sand-grey



555023
medium ochre



555035
medium stone grey



555039
medium sand-grey



555038
light sand-grey



Floor/Wall tile
12.5 x 12.5 cm, 5 x 5 in, smooth,
R10/A

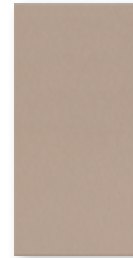

Floor/Wall tile
12.5 x 25 cm, 5 x 10 in, smooth,
R10/A

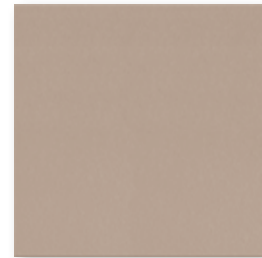

Floor/Wall tile
25 x 25 cm, 10 x 10 in, smooth,
R10/A

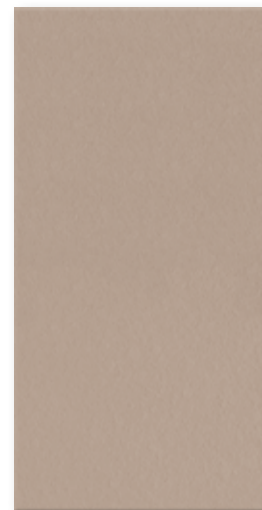

Floor/Wall tile
25 x 50 cm, 10 x 20 in, smooth, R10/A

Grid profile

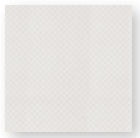

Grid profile tile
12.5 x 12.5 cm, 5 x 5 in, relief, R11/B



Grid profile tile
12.5 x 25 cm, 5 x 10 in, relief, R11/B

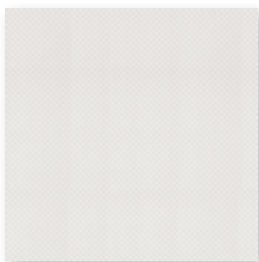

Grid profile tile
25 x 25 cm, 10 x 10 in, relief, R11/B

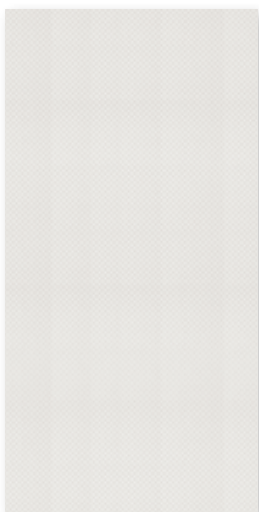

Grid profile tile
25 x 50 cm, 10 x 20 in, relief, R11/B

Shower Tub System

Shower tub system
Corner (one piece)
12.5 x 12.5 cm, 5 x 5 in, smooth, R10/B

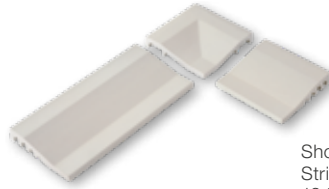

Shower tub system
Strip
12.5 x 12.5 cm, 5 x 5 in
smooth, R10/B

Shower tub system
Strip
25 x 12.5 cm, 10 x 5 in
smooth, R10/B

Cove skirting, r = 12 mm
25 x 12.5 cm, 10 x 5 in, smooth



External angle,
smooth

Internal angle,
smooth

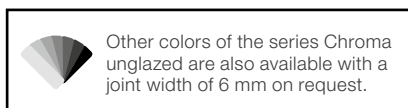

Other colors of the series Chroma unglazed are also available with a joint width of 6 mm on request.

Quantum

Floor/Wall Tiles

12.5 x 12.5 cm³



12.5 x 25 cm



25 x 25 cm



25 x 50 cm^{1/2/4}



Model number	32020H	38110H	32050H	42550HK			
Nom. dim. - cm/in	12.5 x 12.5 / 5 x 5	12.5 x 25 / 5 x 10	25 x 25 / 10 x 10	25 x 50 / 10 x 20			
Work size	119 x 119 x 8 mm	119 x 244 x 8 mm	244 x 244 x 8 mm	244 x 494 x 8 mm			
Surface	smooth, silky-matt	smooth, silky-matt	smooth, silky-matt	smooth, silky-matt			
m ² - pieces	64.000	32.000	16.000	8.000			
m ² - kg	15.360	15.680	16.960	17.040			
Bundle - pieces	66	33	14	9			
Bundle - m ²	1.031	1.031	0.875	1.125			
Bundle - kg	15.840	16.170	14.840	19.170			
Pallet - m ²	86.625	86.625	70.875	40.500			
Pallet - kg	1,330.560	1,358.280	1,202.040	690.120			
Product standard	Alb	Alb	Alb	Alb			
Slip resistance	R10/A	R10/A	R10/A	R10/A			
Stress group	2	2	2	2			
neutral 10	926i-32020H	926i-38110H	926i-32050H	926i-42550HK			
(active white) <input type="checkbox"/>	Price gr. A166 (m ²)	Price gr. A166 (m ²)	Price gr. A166 (m ²)	Price gr. A178 (m ²)			
neutral 1	918i-32020H	918i-38110H	918i-32050H	918i-42550HK			
(deep black) <input type="checkbox"/>	Price gr. A166 (m ²)	Price gr. A166 (m ²)	Price gr. A166 (m ²)	Price gr. A178 (m ²)			
medium ochre <input type="checkbox"/>	555023-32020H^{2/4}	555023-38110H^{2/4}	555023-32050H^{2/4}	555023-42550HK			
	Price gr. A166 (m ²)	Price gr. A166 (m ²)	Price gr. A166 (m ²)	Price gr. A178 (m ²)			
medium stone grey <input type="checkbox"/>	555035-32020H^{2/4}	555035-38110H^{2/4}	555035-32050H^{2/4}	555035-42550HK			
	Price gr. A166 (m ²)	Price gr. A166 (m ²)	Price gr. A166 (m ²)	Price gr. A178 (m ²)			
dark stone grey <input type="checkbox"/>	555036-32020H^{2/4}	555036-38110H^{2/4}	555036-32050H^{2/4}	555036-42550HK			
	Price gr. A166 (m ²)	Price gr. A166 (m ²)	Price gr. A166 (m ²)	Price gr. A178 (m ²)			
light sand-grey <input type="checkbox"/>	555038-32020H^{2/4}	555038-38110H^{2/4}	555038-32050H^{2/4}	555038-42550HK			
	Price gr. A166 (m ²)	Price gr. A166 (m ²)	Price gr. A166 (m ²)	Price gr. A178 (m ²)			
medium sand-grey <input type="checkbox"/>	555039-32020H^{2/4}	555039-38110H^{2/4}	555039-32050H^{2/4}	555039-42550HK			
	Price gr. A166 (m ²)	Price gr. A166 (m ²)	Price gr. A166 (m ²)	Price gr. A178 (m ²)			
dark sand-grey <input type="checkbox"/>	555040-32020H^{2/4}	555040-38110H^{2/4}	555040-32050H^{2/4}	555040-42550HK			
	Price gr. A166 (m ²)	Price gr. A166 (m ²)	Price gr. A166 (m ²)	Price gr. A178 (m ²)			
neutral 3	555113-32020H^{2/4}	555113-38110H^{2/4}	555113-32050H^{2/4}	555113-42550HK			
(asphalt black) <input type="checkbox"/>	Price gr. A166 (m ²)	Price gr. A166 (m ²)	Price gr. A166 (m ²)	Price gr. A178 (m ²)			
neutral 7	555117-32020H^{2/4}	555117-38110H^{2/4}	555117-32050H^{2/4}	555117-42550HK			
(pebble-grey) <input type="checkbox"/>	Price gr. A166 (m ²)	Price gr. A166 (m ²)	Price gr. A166 (m ²)	Price gr. A178 (m ²)			
neutral 8	555118-32020H^{2/4}	555118-38110H^{2/4}	555118-32050H^{2/4}	555118-42550HK			
(light-grey) <input type="checkbox"/>	Price gr. A166 (m ²)	Price gr. A166 (m ²)	Price gr. A166 (m ²)	Price gr. A178 (m ²)			
natural white <input type="checkbox"/>	901i-32020H	901i-38110H	901i-32050H	901i-42550HK			
	Price gr. A166 (m ²)	Price gr. A166 (m ²)	Price gr. A166 (m ²)	Price gr. A178 (m ²)			



³ Supplied as double-tiles; to be broken by customer.

⁴ Minimum order quantity: 200 m²

Quantum

Floor Tiles

12.5 x 12.5 cm³



12.5 x 25 cm



25 x 25 cm



25 x 50 cm^{1/2/4}

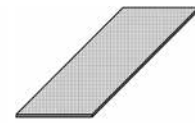

			Grid profile tile	Grid profile tile	Grid profile tile	Grid profile tile	
			32100H	34090H	32080H	42580HK	Model number
			12.5 x 12.5 / 5 x 5	12.5 x 25 / 5 x 10	25 x 25 / 10 x 10	25 x 50 / 10 x 20	Nom. dim. - cm/in
			119 x 119 x 8 mm	119 x 244 x 8 mm	244 x 244 x 8 mm	244 x 494 x 8 mm	Work size
			relief, silky-matt	relief, silky-matt	relief, silky-matt	relief, silky-matt	Surface
			64.000	32.000	16.000	8.000	m ² - pieces
			15.360	15.360	16.800	17.040	m ² - kg
			66	33	14	9	Bundle - pieces
			1.031	1.031	0.875	1.125	Bundle - m ²
			15.840	15.840	14.700	19.170	Bundle - kg
			86.625	86.625	70.875	40.500	Pallet - m ²
			1,330.560	1,330.560	1,190.700	690.120	Pallet - kg
			Alb	Alb	Alb	Alb	Product standard
			R11/B	R11/B	R11/B	R11/B	Slip resistance
			2	2	2	2	Stress group
			926i-32100H	926i-34090H	926i-32080H	926i-42580HK	neutral 10
			Price gr. A178 (m ²)	Price gr. A178 (m ²)	Price gr. A178 (m ²)	Price gr. A196 (m ²)	(active white) <input type="checkbox"/>
			918i-32100H	918i-34090H	918i-32080H	918i-42580HK	neutral 1
			Price gr. A178 (m ²)	Price gr. A178 (m ²)	Price gr. A178 (m ²)	Price gr. A196 (m ²)	(deep black) <input type="checkbox"/>
			555023-32100H ^{2/4}	555023-34090H ^{2/4}	555023-32080H ^{2/4}	555023-42580HK	
			Price gr. A178 (m ²)	Price gr. A178 (m ²)	Price gr. A178 (m ²)	Price gr. A196 (m ²)	medium ochre <input type="checkbox"/>
			555035-32100H ^{2/4}	555035-34090H ^{2/4}	555035-32080H ^{2/4}	555035-42580HK	
			Price gr. A178 (m ²)	Price gr. A178 (m ²)	Price gr. A178 (m ²)	Price gr. A196 (m ²)	medium stone grey <input type="checkbox"/>
			555036-32100H ^{2/4}	555036-34090H ^{2/4}	555036-32080H ^{2/4}	555036-42580HK	
			Price gr. A178 (m ²)	Price gr. A178 (m ²)	Price gr. A178 (m ²)	Price gr. A196 (m ²)	dark stone grey <input type="checkbox"/>
			555038-32100H ^{2/4}	555038-34090H ^{2/4}	555038-32080H ^{2/4}	555038-42580HK	
			Price gr. A178 (m ²)	Price gr. A178 (m ²)	Price gr. A178 (m ²)	Price gr. A196 (m ²)	light sand-grey <input type="checkbox"/>
			555039-32100H ^{2/4}	555039-34090H ^{2/4}	555039-32080H ^{2/4}	555039-42580HK	
			Price gr. A178 (m ²)	Price gr. A178 (m ²)	Price gr. A178 (m ²)	Price gr. A196 (m ²)	medium sand-grey <input type="checkbox"/>
			555040-32100H ^{2/4}	555040-34090H ^{2/4}	555040-32080H ^{2/4}	555040-42580HK	
			Price gr. A178 (m ²)	Price gr. A178 (m ²)	Price gr. A178 (m ²)	Price gr. A196 (m ²)	dark sand-grey <input type="checkbox"/>
			555113-32100H ^{2/4}	555113-34090H ^{2/4}	555113-32080H ^{2/4}	555113-42580HK	
			Price gr. A178 (m ²)	Price gr. A178 (m ²)	Price gr. A178 (m ²)	Price gr. A196 (m ²)	neutral 3
			555117-32100H ^{2/4}	555117-34090H ^{2/4}	555117-32080H ^{2/4}	555117-42580HK	(asphalt black) <input type="checkbox"/>
			Price gr. A178 (m ²)	Price gr. A178 (m ²)	Price gr. A178 (m ²)	Price gr. A196 (m ²)	neutral 7
			555118-32100H ^{2/4}	555118-34090H ^{2/4}	555118-32080H ^{2/4}	555118-42580HK	(pebble-grey) <input type="checkbox"/>
			Price gr. A178 (m ²)	Price gr. A178 (m ²)	Price gr. A178 (m ²)	Price gr. A196 (m ²)	neutral 8
			901i-32100H	901i-34090H	901i-32080H	901i-42580HK	(light-grey) <input type="checkbox"/>
			Price gr. A178 (m ²)	Price gr. A178 (m ²)	Price gr. A178 (m ²)	Price gr. A196 (m ²)	natural white <input type="checkbox"/>



³ Supplied as double-tiles; to be broken by customer.

⁴ Minimum order quantity: 200 m²



Quantum

Shower Tub System²

12.5 x 25 cm



12.5 x 12.5 cm



12.5 x 12.5 cm



Lip 10 mm
Strip

Lip 10 mm
Strip

Corner

Model number	27182H	27180H	27181H
Nom. dim. - cm/in	12.5 x 25 / 5 x 10	12.5 x 12.5 / 5 x 5	12.5 x 12.5 / 5 x 5
Work size	119 x 244 x 18/8 mm	119 x 119 x 18/8 mm	119 x 119 x 18/8 mm
Surface	smooth, silky-matt	smooth, silky-matt	smooth, silky-matt
m - pieces	4.000	8.000	
m/pce. - kg	2.720/m	2.720/m	0.500/Stück
Bundle - pieces	22	44	12
Bundle - m	5.500	5.500	
Bundle - kg	14.960	14.960	6.000
Pallet - m			
Pallet - kg			
Product standard	Alb	Alb	Alb
Slip resistance	R10/B	R10/B	R10/B
neutral 10	926i-27182H	926i-27180H	926i-27181H
(active white) <input type="checkbox"/>	Price gr. A506 (pce.)	Price gr. A455 (pce.)	Price gr. A489 (pce.)
neutral 1	918i-27182H	918i-27180H	918i-27181H
(deep black) <input type="checkbox"/>	Price gr. A506 (pce.)	Price gr. A455 (pce.)	Price gr. A489 (pce.)
medium ochre <input type="checkbox"/>	555023-27182H ¹	555023-27180H ¹	555023-27181H ¹
	Price gr. A506 (pce.)	Price gr. A455 (pce.)	Price gr. A489 (pce.)
medium stone grey <input type="checkbox"/>	555035-27182H ¹	555035-27180H ¹	555035-27181H ¹
	Price gr. A506 (pce.)	Price gr. A455 (pce.)	Price gr. A489 (pce.)
dark stone grey <input type="checkbox"/>	555036-27182H ¹	555036-27180H ¹	555036-27181H ¹
	Price gr. A506 (pce.)	Price gr. A455 (pce.)	Price gr. A489 (pce.)
light sand-grey <input type="checkbox"/>	555038-27182H ¹	555038-27180H ¹	555038-27181H ¹
	Price gr. A506 (pce.)	Price gr. A455 (pce.)	Price gr. A489 (pce.)
medium sand-grey <input type="checkbox"/>	555039-27182H ¹	555039-27180H ¹	555039-27181H ¹
	Price gr. A506 (pce.)	Price gr. A455 (pce.)	Price gr. A489 (pce.)
dark sand-grey <input type="checkbox"/>	555040-27182H ¹	555040-27180H ¹	555040-27181H ¹
	Price gr. A506 (pce.)	Price gr. A455 (pce.)	Price gr. A489 (pce.)
neutral 3	555113-27182H ¹	555113-27180H ¹	555113-27181H ¹
(asphalt black) <input type="checkbox"/>	Price gr. A506 (pce.)	Price gr. A455 (pce.)	Price gr. A489 (pce.)
neutral 7	555117-27182H ¹	555117-27180H ¹	555117-27181H ¹
(pebble-grey) <input type="checkbox"/>	Price gr. A506 (pce.)	Price gr. A455 (pce.)	Price gr. A489 (pce.)
neutral 8	555118-27182H ¹	555118-27180H ¹	555118-27181H ¹
(light-grey) <input type="checkbox"/>	Price gr. A506 (pce.)	Price gr. A455 (pce.)	Price gr. A489 (pce.)
natural white <input type="checkbox"/>	901i-27182H	901i-27180H	901i-27181H
	Price gr. A506 (pce.)	Price gr. A455 (pce.)	Price gr. A489 (pce.)



² For details, refer to page 535

Quantum

Safety Strip Tile^{1/2}

6.2 x 25 cm



*rounded
long edge*

Skirtings¹

7.9 x 25 cm



Skirting

12.5 x 25 cm



*Cove Skirting,
r = 12 mm*



*External Corner
mitred pair*



*Internal Corner
mitred pair*

	<i>rounded long edge</i>	<i>Skirting</i>	<i>Cove Skirting, r = 12 mm</i>	<i>External Corner mitred pair</i>	<i>Internal Corner mitred pair</i>	
	34306H	34020H	37080	37081	37082	Model number
	6.2 x 25 / 2 1/2 x 10	7.9 x 25 / 3 1/8 x 10	12.5 x 25 / 5 x 10			Nom. dim. - cm /in
	56 x 244 x 8 mm	73 x 244 x 8 mm	125 x 244/12 x 8 mm	(2x) 131 x 125/12 x 8 mm	(2x) 119 x 125/12 x 8 mm	Work size
	gerillt, silky-matt	smooth, silky-matt	smooth, silky-matt	smooth, silky-matt	smooth, silky-matt	Surface
	4.000	4.000	4.000			m - pieces
	0.800/m	1.160/m	2.520/m	0.600/pair	0.400/pair	m/pair - kg
	66 Stück	33 Stück	20 Stück	10 pair	10 pair	Bundle - pce./pair
	16.500	8.250	5.000			Bundle - m
	13.200	9.570	12.600	6.000	4.000	Bundle - kg
						Pallet - m
						Pallet - kg
	Alb	Alb	Alb	Alb	Alb	Product standard
	-/C		R10/A	R10/A	R10/A	Slip resistance
		926i-34020H	926-37080	926-37081	926-37082	neutral 10
		Price gr. A410 (pce.)	Price gr. A423 (pce.)	Price gr. A455 (pair)	Price gr. A455 (pair)	(active white) <input type="checkbox"/> VO
	918i-34306H	918i-34020H	918-37080	918-37081	918-37082	neutral 1
	Price gr. A434 (pce.)	Price gr. A410 (pce.)	Price gr. A423 (pce.)	Price gr. A455 (pair)	Price gr. A455 (pair)	(deep black) <input type="checkbox"/> VO
		901i-34020H	901-37080	901-37081	901-37082	natural white <input type="checkbox"/> VO
		Price gr. A410 (pce.)	Price gr. A423 (pce.)	Price gr. A455 (pair)	Price gr. A455 (pair)	



² Especially suitable for non-slip and clearly visible (stair) edge design.







Harmonious feeling of homeliness

With its wall tiles in the colors silver-grey and sand-beige, the series Concrete creates a natural and harmonious living atmosphere. Eye-catching accents can be set with the Screen and Stripes mosaic tiles in graphite and sand-beige along with the matching borders. The wall tiles are easy to clean thanks to their Hytect surface.

Studio photo



Wall tile 30 x 60 cm, 12 x 24 in, silver-grey, structured



Wall tile 30 x 60 cm, 12 x 24 in, sand-beige, structured

Decoration Elements

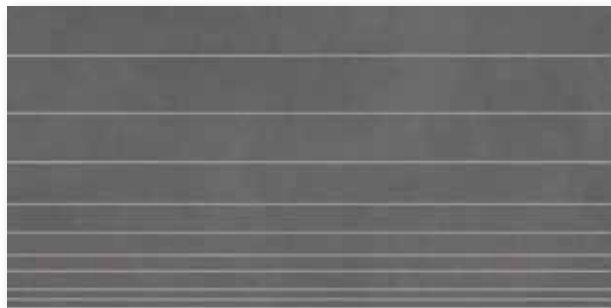

Mosaic tile Stripes 30 x 60 cm, 12 x 24 in, anthracite, structured



Mosaic tile Stripes 30 x 60 cm, 12 x 24 in, sand-beige, structured

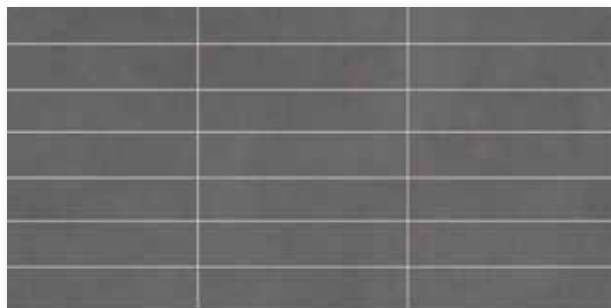

Mosaic tile Screen 30 x 60 cm, 12 x 24 in, anthracite, structured

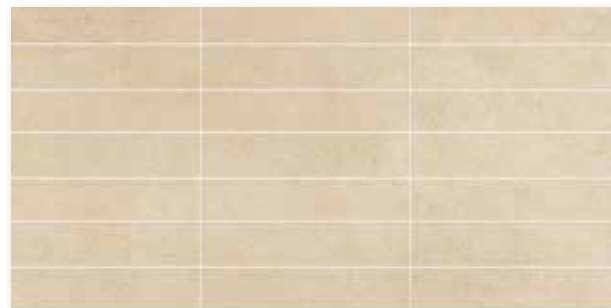

Mosaic tile Screen 30 x 60 cm, 12 x 24 in, sand-beige, structured

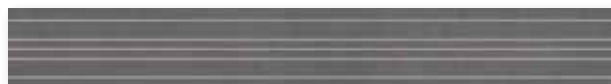

Border Stripes 8 x 60 cm, 3.2 x 24 in, anthracite, structured



Border Stripes 8 x 60 cm, 3.2 x 24 in, sand-beige, structured

Wall Tiles² Decoration Elements^{1/3}

30 x 60 cm



30 x 60 cm



30 x 60 cm⁴

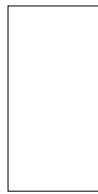

30 x 60 cm



30 x 60 cm⁴

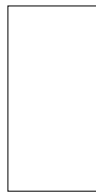

8 x 60 cm



8 x 60 cm⁴



	Mosaic tile Stripes	Mosaic tile Stripes	Mosaic tile Screen	Mosaic tile Screen	Border Stripes	Border Stripes	
30 x 60 / 12 x 24	30 x 60 / 12 x 24	30 x 60 / 12 x 24	30 x 60 / 12 x 24	30 x 60 / 12 x 24	8 x 60 / 3 3/16 x 24	8 x 60 / 3 3/16 x 24	Nom. dim. - cm/in
296 x 595 x 9 mm	297 x 597 x 10.5 mm	296 x 595 x 10 mm	297 x 597 x 10.5 mm	296 x 595 x 10 mm	80 x 597 x 10.5 mm	80 x 595 x 10 mm	Work size
structured, silky-matt	structured, matt	structured, matt	structured, matt	structured, matt	structured, matt	structured, matt	Surface
5.556/m ²	1.667/m	1.667/m	1.667/m	1.667/m	1.667/m	1.667/m	m² - pieces
14.946/m ²	6.668/m	6.668/m	6.668/m	6.668/m	1.779/m	1.779/m	m² - kg
9	2	2	2	2	4	4	Bundle - pieces
1.620 m ²	1.200 m	1.200 m	1.200 m	1.200 m	2.400 m	2.400 m	Bundle - m ²
24.210	8.000	8.000	8.000	8.000	4.268	4.268	Bundle - kg
77.754							Pallet - m ²
1,162.080							Pallet - kg
BIII	Bla	Bla	Bla	Bla	Bla	Bla	Product standard
280345							silver-grey <input type="checkbox"/> V2
Price gr. C56 (m ²)							sand-beige <input type="checkbox"/> V2
280354		280360		280362		280361	anthracite <input type="checkbox"/> V2
Price gr. C56 (m ²)		Price gr. C486 (pce.)		Price gr. C491 (pce.)		Price gr. C447 (pce.)	
	280349-73		280351-73		280350-73		
	Price gr. C486 (pce.)		Price gr. C491 (pce.)		Price gr. C447 (pce.)		



¹
² not frost-proof
³ Decoration elements only available in full boxes.
⁴ without Hytect coating





Inspiring and modern

The heritage hype in fashion, lifestyle and technology which has been going on for years has also left its mark on tiles. Craft evokes familiarity while appearing surprisingly modern. Equally suited for indoor and outdoor use, the series owes its handcrafted character to the depth and transparency of its high-gloss glaze. Compositions of alkaline earths, fluxes, and metal oxides interacting with the clay body create particularly luminous, intense colors and typical surface structures when the tiles are fired openly.

Bar Bardem, Helsinki, Finland / Architect: Fyra Ltd.
Photo: Riikka Kantinkoski

Mono-colors Flamed colors

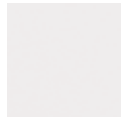

pure white



olive-green flamed



white



golden-yellow flamed



medium grey



amber flamed



dark grey



blue-green flamed



jade-green



beryl-red

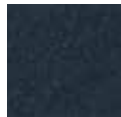

benit-blue



hematite-black

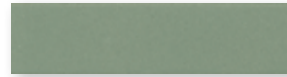

Strip tile 6.2 x 25 cm, 2 1/2 x 10 in, smooth



Strip tile, wave profile 6.2 x 25 cm, 2 1/2 x 10 in, profiled



Strip tile, grooved profile 6.2 x 25 cm, 2 1/2 x 10 in, profiled



Strip tile, V-pointed profile 6.2 x 25 cm, 2 1/2 x 10 in, profiled



Double-tip tile 12.5 x 25 cm, 5 x 10 in, profiled

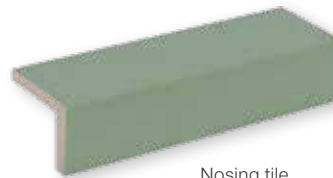

Nosing tile
6.2 x 25 cm, 2 1/2 x 10 in,
smooth

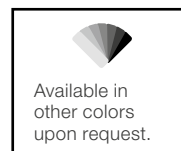

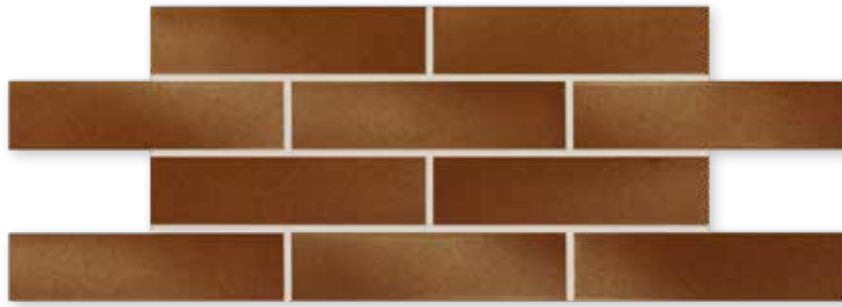

Strip tile 6.2 x 25 cm, 2 1/2 x 10 in

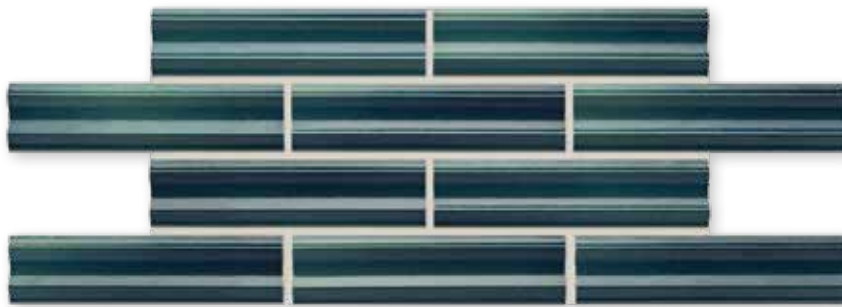

Strip tile, wave profile 6.2 x 25 cm, 2 1/2 x 10 in



Double-tip strip tile 12.5 x 25 cm, 5 x 10 in



Strip tile, V-pointed profile 6.2 x 25 cm, 2 1/2 x 10 in



Strip tile, grooved profile 6.2 x 25 cm, 2 1/2 x 10 in

Strip Tiles²

Double-Tip
Tile

Nosing Tile, **NEW**
glued^{1/4}

6.2 x 25 cm



6.2 x 25 cm



6.2 x 25 cm⁵



6.2 x 25 cm



12.5 x 25 cm



6.2 x 25 cm



	2120	2250	2270	2280	2240	2821	Model number
	6.2 x 25 / 2 1/2 x 10	6.2 x 25 / 2 1/2 x 10	6.2 x 25 / 2 1/2 x 10	6.2 x 25 / 2 1/2 x 10	12.5 x 25 / 5 x 10	6.2 x 25 / 2 1/2 x 10	Nom. dim. - cm/in
	52 x 240 x 11 mm	52 x 240 x 16/11 mm	52 x 240 x 18/11 mm	52 x 240 x 11 mm	115 x 240 x 20/11 mm	52 x 52 x 240 x 11 mm	Work size
	smooth, glossy	profiled, glossy	profiled, glossy	profiled, glossy	profiled, glossy	smooth, glossy	Surface
	67.000/m ²	67.000/m ²	67.000/m ²	67.000/m ²	33.000/m ²	4.000/m	m ² - pieces
	20.100/m ²	21.775/m ²	27.470/m ²	21.440/m ²	27.060/m ²	2.400/m	m ² - kg
	46	34	30	44	14		Bundle - pieces
	0.687	0.507	0.448	0.657	0.209		Bundle - m ²
	13.800	11.050	12.300	14.080	11.480		Bundle - kg
	57.678	42.627	37.612	55.164	35.636		Pallet - m ²
	1,159.200	928.200	1,033.200	1,182.720	964.320		Pallet - kg
	Alla	Alla	Alla	Alla	Alla	Alla	Product standard
							Slip resistance
							Stress group
	9027-2120H	9027-2250H	9027-2270H	9027-2280H	9027-2240H	<i>9027-2821H</i>	pure white <input type="checkbox"/> V1
	Price gr. A187 (m ²)	Price gr. A253 (m ²)	Price gr. A253 (m ²)	Price gr. A253 (m ²)	Price gr. A268 (m ²)		
	9026-2120H	9026-2250H	9026-2270H	9026-2280H	9026-2240H	<i>9026-2821H</i>	white <input type="checkbox"/> V1
	Price gr. A187 (m ²)	Price gr. A253 (m ²)	Price gr. A253 (m ²)	Price gr. A253 (m ²)	Price gr. A268 (m ²)		
	9022-2120H	9022-2250H	9022-2270H	9022-2280H	9022-2240H	<i>9022-2821H</i>	mid-grey <input type="checkbox"/> V1
	Price gr. A187 (m ²)	Price gr. A253 (m ²)	Price gr. A253 (m ²)	Price gr. A253 (m ²)	Price gr. A268 (m ²)		
	9021-2120H	<i>9021-2250H^{1/3}</i>	<i>9021-2270H^{1/3}</i>	<i>9021-2280H^{1/3}</i>	<i>9021-2240H^{1/3}</i>	<i>9021-2821H</i>	dark-grey <input type="checkbox"/> V1
	Price gr. A187 (m ²)	Price gr. A253 (m ²)	Price gr. A253 (m ²)	Price gr. A253 (m ²)	Price gr. A268 (m ²)		
	9020-2120H	9020-2250H	9020-2270H	9020-2280H	9020-2240H	<i>9020-2821H</i>	olive-green flamed <input type="checkbox"/> V2
	Price gr. A187 (m ²)	Price gr. A253 (m ²)	Price gr. A253 (m ²)	Price gr. A253 (m ²)	Price gr. A268 (m ²)		
	9023-2120H	<i>9023-2250H^{1/3}</i>	<i>9023-2270H^{1/3}</i>	<i>9023-2280H^{1/3}</i>	<i>9023-2240H^{1/3}</i>	<i>9023-2821H</i>	golden-yellow flamed <input type="checkbox"/> V3
	Price gr. A187 (m ²)	Price gr. A253 (m ²)	Price gr. A253 (m ²)	Price gr. A253 (m ²)	Price gr. A268 (m ²)		
	9025-2120H	9025-2250H	9025-2270H	9025-2280H	9025-2240H	<i>9025-2821H</i>	amber flamed <input type="checkbox"/> V2
	Price gr. A253 (m ²)	Price gr. A253 (m ²)	Price gr. A253 (m ²)	Price gr. A253 (m ²)	Price gr. A268 (m ²)		
	9024-2120H	9024-2250H	9024-2270H	9024-2280H	9024-2240H	<i>9024-2821H</i>	blue green flamed <input type="checkbox"/> V3
	Price gr. A187 (m ²)	Price gr. A253 (m ²)	Price gr. A253 (m ²)	Price gr. A253 (m ²)	Price gr. A268 (m ²)		
	9030-2120H	9030-2250H	9030-2270H	9030-2280H	9030-2240H	<i>9030-2821H</i>	jade-green <input type="checkbox"/> V1
	Price gr. A187 (m ²)	Price gr. A253 (m ²)	Price gr. A253 (m ²)	Price gr. A253 (m ²)	Price gr. A268 (m ²)		
	9031-2120H	<i>9031-2250H^{1/3}</i>	<i>9031-2270H^{1/3}</i>	<i>9031-2280H^{1/3}</i>	<i>9031-2240H^{1/3}</i>	<i>9031-2821H</i>	beryl-red <input type="checkbox"/> V1
	Price gr. A187 (m ²)	Price gr. A253 (m ²)	Price gr. A253 (m ²)	Price gr. A253 (m ²)	Price gr. A268 (m ²)		
	9032-2120H	<i>9032-2250H^{1/3}</i>	<i>9032-2270H^{1/3}</i>	<i>9032-2280H^{1/3}</i>	<i>9032-2240H^{1/3}</i>	<i>9032-2821H</i>	benit-blue <input type="checkbox"/> V1
	Price gr. A187 (m ²)	Price gr. A253 (m ²)	Price gr. A253 (m ²)	Price gr. A253 (m ²)	Price gr. A268 (m ²)		
	9033-2120H	<i>9033-2250H^{1/3}</i>	<i>9033-2270H^{1/3}</i>	<i>9033-2280H^{1/3}</i>	<i>9033-2240H^{1/3}</i>	<i>9033-2821H</i>	hematite-black <input type="checkbox"/> V1
	Price gr. A187 (m ²)	Price gr. A253 (m ²)	Price gr. A253 (m ²)	Price gr. A253 (m ²)	Price gr. A268 (m ²)		



² Supplied as double-tiles; to be broken by customer.

³ Minimum order quantity: 250 m²

⁴ The format 2821 is produced with a glued edge. The price is calculated project-specifically.

⁵ For format 2270: Due to manufacturing reasons, right and left overglazed short edges are generated at a ratio of 1:1 in the case of this article, which have to be purchased by the customer. Only one longitudinal edge can be glazed.

For the series Craft:

Minimum order quantity in the case of special colors: 500 m²

Price for lower quantities on request.

The customer agrees to purchase a possible overproduction of 10 %.

Overglazed edge(s) possible up to max. 25 % of the order quantity.

A separate order is necessary.

The nosing tiles 12.5 x 25 cm can be produced with glued edge on request. The price is calculated project-specifically.



Residential quarter Bellaria, Zürich-Wollishofen, Switzerland / Architect: Michael Meier and Marius Hug Architekten AG, Zurich, Switzerland / Photo: Adriano Faragulo

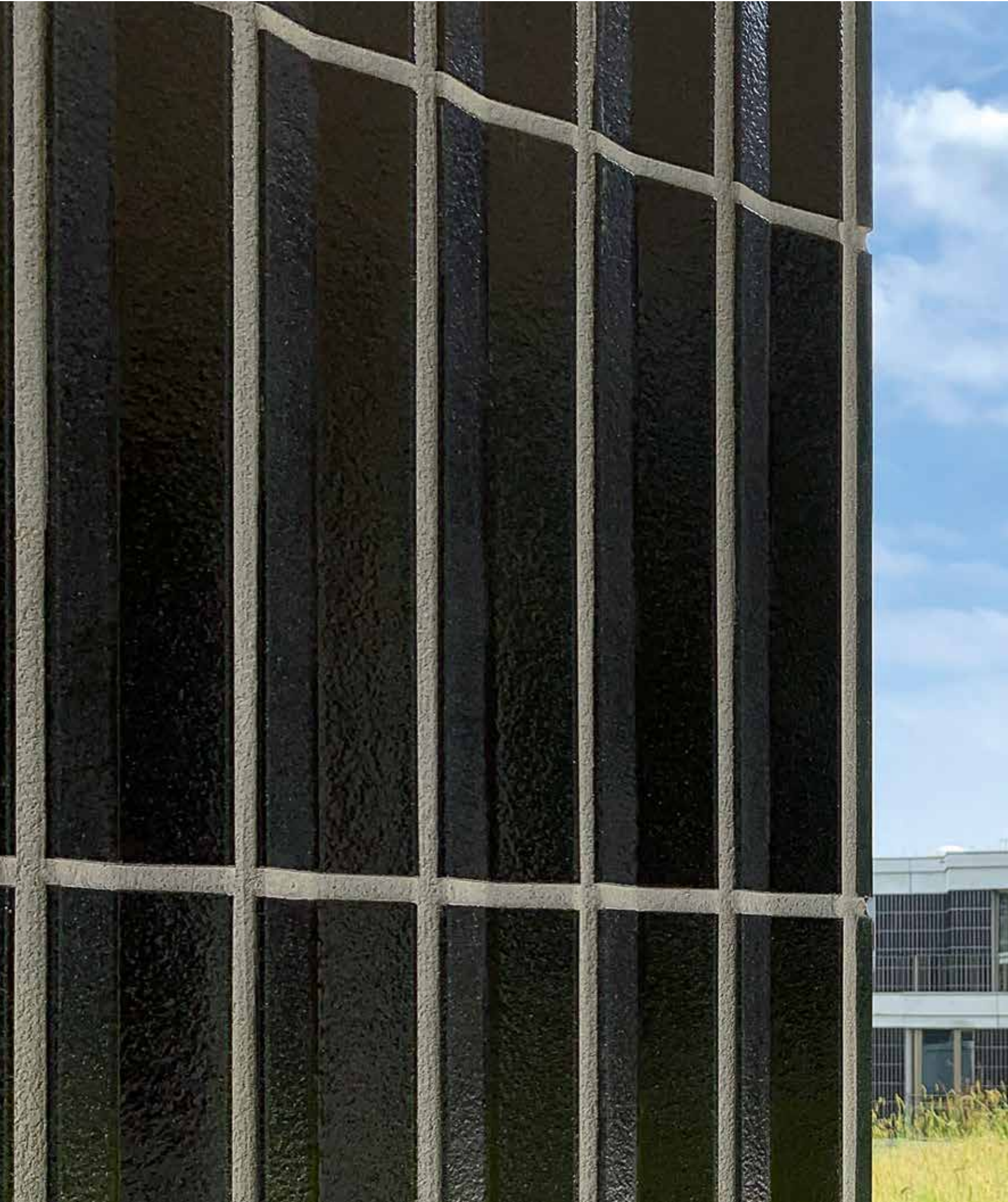



Mono-colors

Flamed colors



lime-white



natural-white



pearl-grey



natural-grey



reseda-green



crimson



cobalt-blue

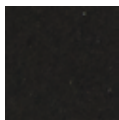

deep black



reed-green flamed



red-brown flamed



petrol-blue flamed



Long strip tile 6.2 x 50 cm, 2 1/2 x 20 in, smooth



Long strip tile, V-pointed profile, symmetrical 6.2 x 50 cm, 2 1/2 x 20 in, profiled



Cover tile, drip edge, 31 x 30 cm, 12 13/64 x 12 in, smooth

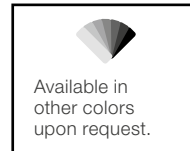

6.2 x 50 cm

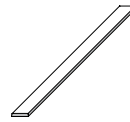

Strip Tile

6.2 x 50 cm

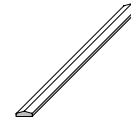

Long strip tile,
V-pointed
profile, symmetrical

31 x 30 cm¹



Cover tile,
drip edge



				2320	2290	9215			Model number
				6.2 x 50 / 2 1/2 x 20	6.2 x 50 / 2 1/2 x 20	31 x 30 / 12 13/64 x 12			Nom. dim. - cm/in
				52 x 490 x 11 mm	52 x 490 x 18/11 mm	300 x 300 x 15 mm			Work size
				smooth, glossy	profiled, glossy	smooth, glossy			Surface
				32.258/m ²	32.258/m ²	3.226/m			m ² /m - pieces
				18.710/m ²	27.097 m ²	8.904/m			m ² /m - kg
				22	13	8			Bundle - pieces
				0.682 m ²	0.403 m ²	2.480 m			Bundle - m ² /m
				12.760	10.920	22.080			Bundle - kg
				40.920	24.180				Pallet - m ²
				765.600	655.200				Pallet - kg
				Alla	Alla	Alla			Product standard
				19027-2320H	19027-2290H	19027-9215H			lime-white <input type="checkbox"/> V1
				Price gr. A175 (m ²)	Price gr. A274 (m ²)	Price gr. A471 (pce.)			
				19026-2320H	19026-2290H	19026-9215H			natural white <input type="checkbox"/> V1
				Price gr. A175 (m ²)	Price gr. A274 (m ²)	Price gr. A471 (pce.)			
				19022-2320H	19022-2290H	19022-9215H			pearl-grey <input type="checkbox"/> V1
				Price gr. A175 (m ²)	Price gr. A274 (m ²)	Price gr. A471 (pce.)			
				19021-2320H	19021-2290H ^{1/2}	19021-9215H			natural-grey <input type="checkbox"/> V1
				Price gr. A175 (m ²)	Price gr. A274 (m ²)	Price gr. A471 (pce.)			
				19020-2320H	19020-2290H	19020-9215H			reed-green <input type="checkbox"/> V2
				Price gr. A175 (m ²)	Price gr. A274 (m ²)	Price gr. A471 (pce.)			
				19025-2320H	19025-2290H	19025-9215H			flamed <input type="checkbox"/> V3
				Price gr. A175 (m ²)	Price gr. A274 (m ²)	Price gr. A471 (pce.)			
				19024-2320H	19024-2290H	19024-9215H			petrol-blue <input type="checkbox"/> V3
				Price gr. A175 (m ²)	Price gr. A274 (m ²)	Price gr. A471 (pce.)			
				19030-2320H	19030-2290H	19030-9215H			reseda-green <input type="checkbox"/> V1
				Price gr. A175 (m ²)	Price gr. A274 (m ²)	Price gr. A471 (pce.)			
				19031-2320H	19031-2290H ^{1/2}	19031-9215H			crimson <input type="checkbox"/> V1
				Price gr. A175 (m ²)	Price gr. A274 (m ²)	Price gr. A471 (pce.)			
				19032-2320H	19032-2290H ^{1/2}	19032-9215H			cobalt blue <input type="checkbox"/> V1
				Price gr. A175 (m ²)	Price gr. A274 (m ²)	Price gr. A471 (pce.)			
				19033-2320H	19033-2290H ^{1/2}	19033-9215H			deep black <input type="checkbox"/> V1
				Price gr. A175 (m ²)	Price gr. A274 (m ²)	Price gr. A471 (pce.)			



¹



² Minimum order quantity: 250 m²

For the series Craft Extended:

Minimum order quantity in the case of special colors: 500 m²

Price for lower quantities on request.

The customer agrees to purchase a possible overproduction of 10 %.

Overglazed edge(s) possible up to max. 25 % of the order quantity,
a separate order is necessary.



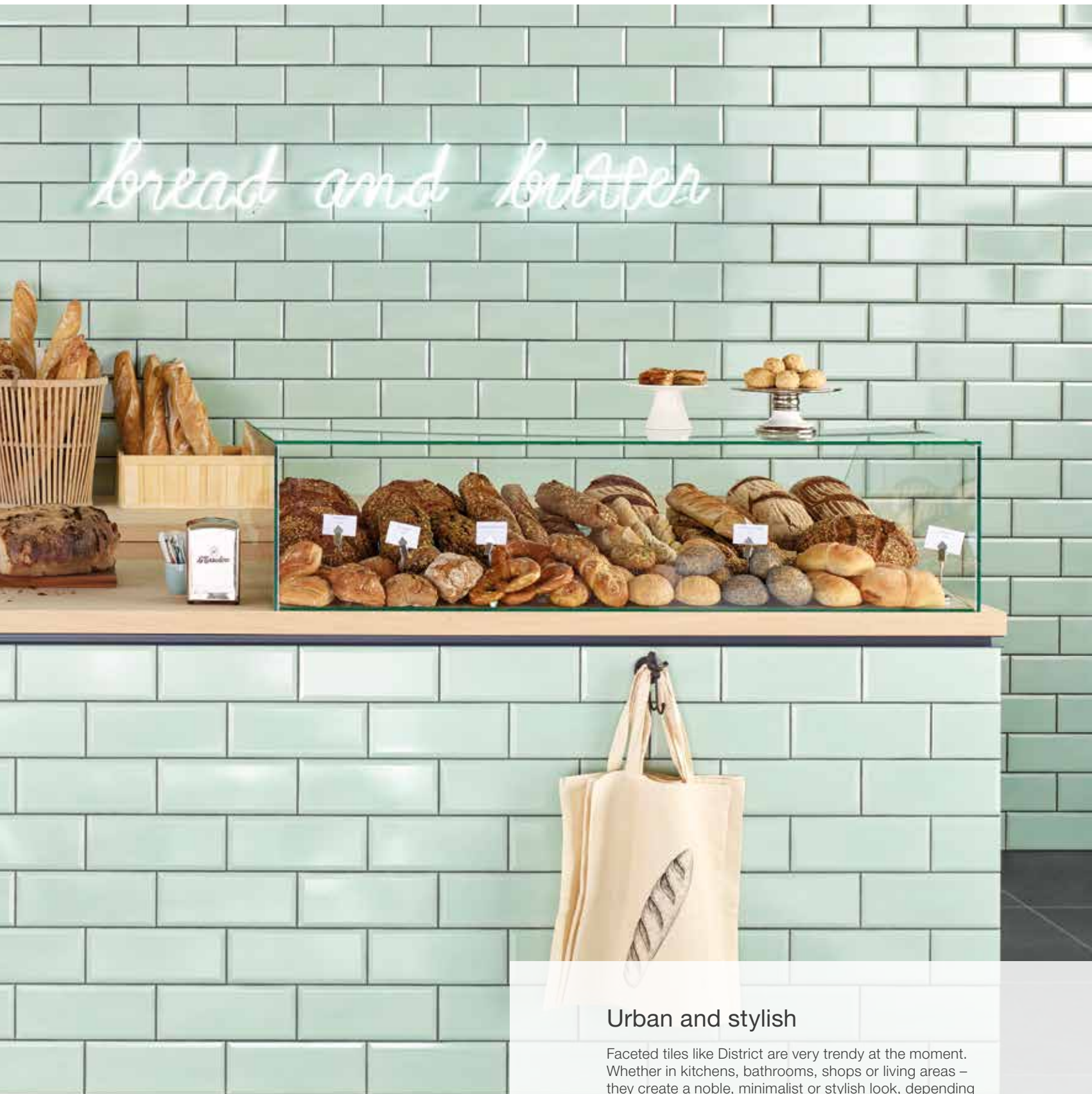

Urban and stylish

Faceted tiles like District are very trendy at the moment. Whether in kitchens, bathrooms, shops or living areas – they create a noble, minimalist or stylish look, depending on the color and area of application. With District, there are eight trendy colors to choose from. All are available in the formats of 5 x 10 cm and 10 x 25 cm. Thanks to the thermoplastic glueing on the back in the case of the 5 x 10 cm format, they are particularly easy to lay as sheets in addition.

Studio photo / Architect: VSBL, Belgrade, Serbia / Photo: Jochen Stüber



Wall tile 5 x 10 cm, 2 x 4 in, Facette almond beige, relief

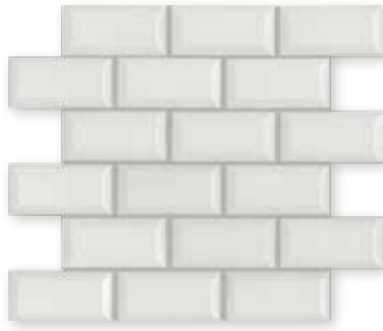

Wall tile 5 x 10 cm, 2 x 4 in, Facette white, relief



Wall tile 10 x 25 cm, 4 x 10 in, Facette almond beige, relief

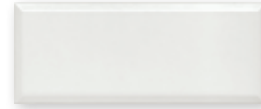

Wall tile 10 x 25 cm, 4 x 10 in, Facette white, relief

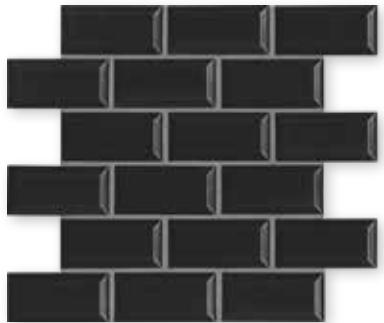

Wall tile 5 x 10 cm, 2 x 4 in, Facette pitch black, relief



Wall tile 5 x 10 cm, 2 x 4 in, Facette ash grey, relief

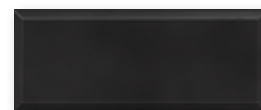

Wall tile 10 x 25 cm, 4 x 10 in, Facette pitch black, relief



Wall tile 10 x 25 cm, 4 x 10 in, Facette ash grey, relief



Wall tile 5 x 10 cm, 2 x 4 in, Facette miami mint, relief

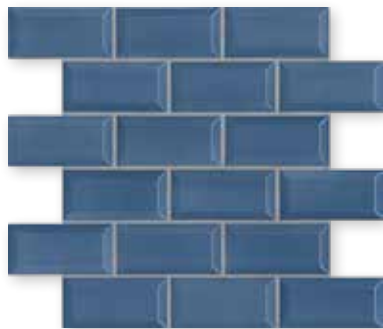

Wall tile 5 x 10 cm, 2 x 4 in, Facette denim blue, relief



Wall tile 10 x 25 cm, 4 x 10 in, Facette miami mint, relief



Wall tile 10 x 25 cm, 4 x 10 in, Facette denim blue, relief



Wall tile 5 x 10 cm, 2 x 4 in, Facette racing green, relief

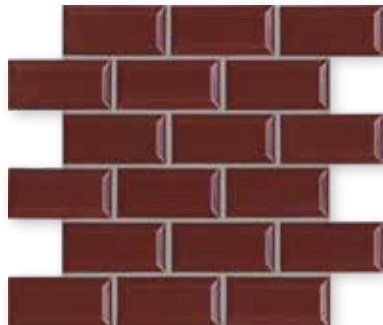

Wall tile 5 x 10 cm, 2 x 4 in, Facette burgundy red, relief



Wall tile 10 x 25 cm, 4 x 10 in, Facette racing green, relief



Wall tile 10 x 25 cm, 4 x 10 in, Facette burgundy red, relief



Mosaics glued thermoplastically on back of Agrob Buchtal can be used not only in dry zones but also without any problems in underwater areas (e.g. swimming pools/whirlpools) as well as in permanently wet areas.

Wall Tiles

5 x 10 cm¹

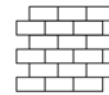

10 x 25 cm



Facette

Sheet: 316 x 316 mm

Facette



					5 x 10 / 2 x 4	10 x 25 / 4 x 10		Nom. dim. - cm/in
					50 x 102 x 6.5 mm	97 x 247 x 6.5 mm		Work size
					relief, glossy	relief, glossy		Surface
					10 sheets	40.000		m ² - pieces
					16.570	19.000		m ² - kg
					8 sheets	20		Bundle - pieces
					0.800	0.500		Bundle - m ²
					13.256	9.500		Bundle - kg
					48.000	64.000		Pallet - m ²
					795.360	1,216.000		Pallet - kg
					Blb	Blb		Product standard
					45550H	45600H		
					Price gr. A169 (m ²)	Price gr. A151 (m ²)		almond beige <input type="checkbox"/>
					45551H	45601H		
					Price gr. A169 (m ²)	Price gr. A151 (m ²)		white <input type="checkbox"/>
					45552H	45602H		
					Price gr. A169 (m ²)	Price gr. A151 (m ²)		pitch black <input type="checkbox"/>
					45553H	45603H		
					Price gr. A169 (m ²)	Price gr. A151 (m ²)		ash grey <input type="checkbox"/>
					45554H	45604H		
					Price gr. A169 (m ²)	Price gr. A151 (m ²)		miami mint <input type="checkbox"/>
					45555H	45605H		
					Price gr. A169 (m ²)	Price gr. A151 (m ²)		denim blue <input type="checkbox"/>
					45556H	45606H		
					Price gr. A169 (m ²)	Price gr. A151 (m ²)		racing green <input type="checkbox"/>
					45557H	45607H		
					Price gr. A169 (m ²)	Price gr. A151 (m ²)		burgundy red <input type="checkbox"/>



Only suitable for laying on the wall.





Conductive floor coverings

These two specific solutions – as a stoneware tile (Eladuct) on the one hand and as a ceramic large-size panel in model size 60 x 60 cm on the other (ELA 10.6) – are suitable for use in those areas where electrostatic charge requires a conductive floor covering or where the latter is recommended. The special laying instructions must be followed carefully. We shall be delighted to advise you and to give you assistance for individual applications.

Eladuct



Static electricity conducting stoneware tiles, unglazed



355S
Eladuct unglazed

Sectional Drawing

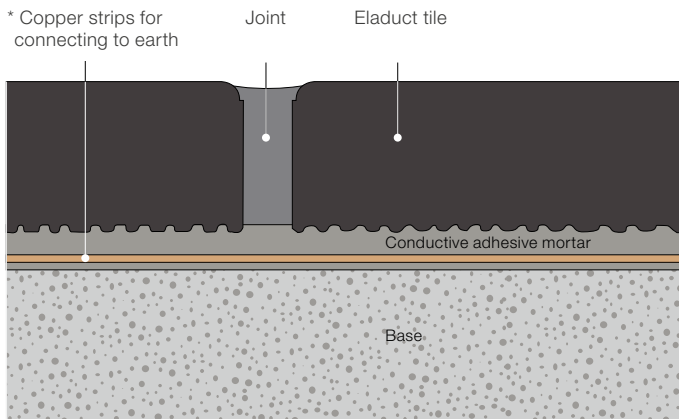

* Number and arrangement depending on the technical requirements.
Connection only by an electrical specialist in line with the relevant guidelines.

In the case of Eladuct, static electricity is discharged through the tile body.
Volume resistance according to Procedure A pursuant to DIN EN 1081: 10^8 Ohm.

Conductive Floor Coverings

These two specific solutions – as a stoneware tile (Eladuct) on the one hand and as a ceramic large-size panel in model size 60 x 60 cm on the other (ELA 10.6) – are suitable for use in those areas where electrostatic charge requires a conductive floor covering or where the latter is recommended. The special laying instructions must be followed carefully. We shall be delighted to advise you and to give you assistance for individual applications.

Eladuct

is especially predestined for those areas where the discharge of static electricity is desired together with the advantages of an unglazed surface (high mechanical-chemical stress resistance).

Examples: gravure and flexographic printing areas, laboratories, rooms for lacquer production, processing and decanting, munitions dumps, chemical production plants etc.

KerAion ELA 10.6



2401 RH · IV
grey glazed
(RH = non-slip version)

Sectional Drawing

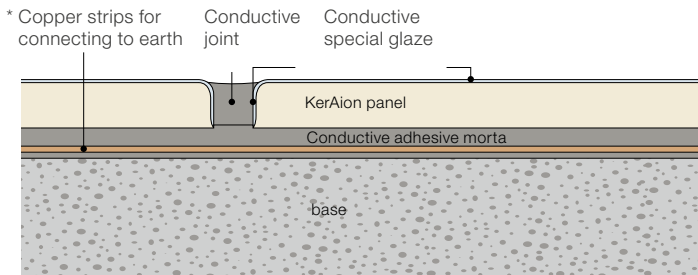

* Number and arrangement depending on the technical requirements.
Connection only by an electrical specialist in line with the relevant guidelines.

In the case of ELA 10.6, static electricity is discharged via the four overglazed panel edges. Surface resistance according to Procedure C pursuant to DIN EN 1081: 10^6 Ohm. Electrical leakage resistance R_A according to DIN EN 1081: 10^6 Ohm.

KerAion ELA 10.6

is recommended for those areas where the discharge of static electricity is desired and importance is attached to the advantages of a glazed surface (e.g. very easy to clean) and a generous, representative look.

Examples: office rooms, production rooms for electronic equipment, physical measuring and work rooms, laboratories, rooms for microchip and computer manufacture, medical areas (e.g. operating theatres), telecommunication workshops, sales areas for electronic equipment etc.

Floor Tiles

Skirtings

25 x 12.5 cm

25 x 8,9 cm



				Cove Skirting <i>r = 9 mm</i>	External corner <i>mitred pair</i>	Internal corner <i>mitred pair</i>	
			1110	4000	4003	4004	Model number
			25 x 12.5 / 10 x 5	25 x 8.9 / 10 x 3 1/2			Nom. dim. - cm/in
			240 x 115 x 20	240 x 79/9 x 11	(2x) 131 x 79/9 x 11	(2x) 115 x 79/9 x 11	Work size - mm
			smooth, matt	smooth, matt	smooth, matt	smooth, matt	Surface
			33.000/m ²	4.000/m			m²/m - pieces
			53.955/m ²	2.200/m	0.590/pair	0.550/pair	m²/m/pair - kg
			13 piece	16 piece	8 pair	8 pair	Bundle - pce./pair
			0.394 m ²	4.000 m			Bundle - m ² /m
			21.255	8.800	4.720	4.400	Bundle - kg
			23.636				Pallet - m ²
			1,275.300				Pallet - kg
			Alb	Alb	Alb	Alb	Product standard
			R10				Slip resistance
			4				Stress group
			355S-1110	355S-4000	355S-4003¹	355S-4004¹	355S Eladuct
			Price gr. A346 (m ²)	Price gr. A467 (pce.)	Price gr. A528 (pair)	Price gr. A528 (pair)	unglazed

In the case of Eladuct, static electricity is discharged through the tile body. Volume resistance according to Procedure A pursuant to DIN EN 1081: 10⁸ Ohm. The 355s is defined by the contact resistance and not by the color setting. Color deviations must be accepted and are no reason for complaint.



KerAion ELA 10.6

Floor Tiles
(static electricity conducting)

Skirtings
(static electricity non-conducting)

60 x 60 cm

30 x 8,7 cm

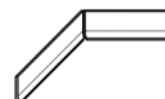
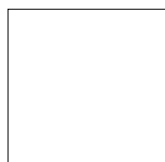

				Cove Skirting <i>r = 12 mm</i>	External corner left	External corner right	Internal corner <i>mitred pair</i>	
			K100	37040	37043	37044	37042	Model number
			60 x 60 / 24 x 24	30 x 8.7 / 12 x 3 1/2				Nom. dim. - cm/in
			592 x 592 x 8	292 x 79/12 x 8	280/292 x 79/12 x 8	280/292 x 79/12 x 8	(2x) 292 x 79/12 x 8	Work size - mm
			smooth, matt	smooth, matt	smooth, matt	smooth, matt	smooth, matt	Surface
			2.860/m ²	3.333/m				m²/m - pieces
			18.533/m ²	1.700/m	0.550/piece	0.550/piece	1.100/pair	m²/m/pce./pair - kg
			4 piece	32 piece	32 piece	32 piece	16 pair	Bundle - pce./pair
			1.399 m ²	9.601 m				Bundle - m ² /m
			25.920	16.320	17.600	17.600	17.600	Bundle - kg
			41.958					Pallet - m ²
			777.600					Pallet - kg
			Alb	Alb	Alb	Alb	Alb	Product standard
			R9					Slip resistance
			2					Stress group
			2401RH-K100-21	590-37040-21	590-37043-21	590-37044-21	590-37042-21	4
			Price gr. A346 (m ²)	Price gr. A445 (pce.)	Price gr. A458 (pce.)	Price gr. A458 (pce.)	Price gr. A489 (pair)	grey glazed <input type="checkbox"/> V0
								grey glazed <input type="checkbox"/> V0

In the case of KerAion ELA 10.6, static electricity is discharged via the four overglazed panel edges. Surface resistance according to Procedure C pursuant to DIN EN 1081: 10⁹ Ohm.







Modular and timeless

With colors and surfaces matched to one another, slip-resistant tiles from R9 to R12V4 and formats from 30 x 30 cm to 60 x 60 cm, the tiles of the Emotion series offer architects a great deal of freedom. Emotion ensures good design particularly in areas where transitions between different slip-resistance requirements are needed. This makes front cooking in direct view of restaurant guests just as feasible as the seamless and aesthetically pleasing combination of workshop and showroom in a car dealership.

Studio photo / Architect: Sylvia Leydecker / Photo: Jochen Stüber



R9 R10/A R11/B



Surfaces: Floor tiles

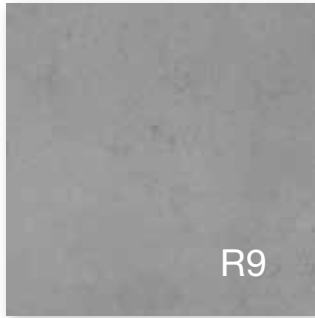

R9

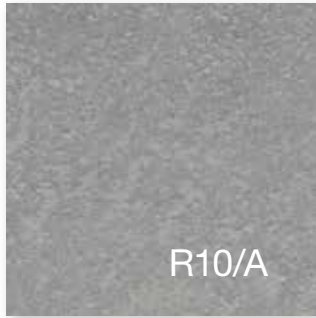

R10/A

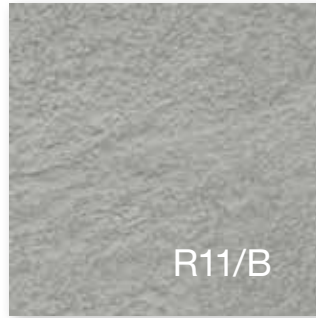

R11/B



basalt



light-beige



deep anthracite

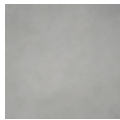

mid-grey



Floor tile 30 x 30 cm, 12 x 12 in structured, R10/A



Floor tile 30 x 30 cm, 12 x 12 in relief, R11/B



Floor tile 30 x 60 cm, 12 x 24 in, smooth, R9
Floor tile 30 x 60 cm, 12 x 24 in, structured, R10/A
Floor tile 30 x 60 cm, 12 x 24 in, relief, R11/B



Floor tile 60 x 60 cm, 24 x 24 in, smooth, R9
Floor tile 60 x 60 cm, 24 x 24 in, structured, R10/A



Stair tile 30 x 60 cm (with grooves), 12 x 24 in, smooth, R9
Stair tile 30 x 60 cm (with grooves), 12 x 24 in, structured, R10/A



Skirting, rounded 7 x 60 cm, 2 13/16 x 24 in, smooth
Skirting, rounded 7 x 60 cm, 2 13/16 x 24 in, structured

Ceramic channel cover
Corner solution 30 x 30 cm, 12 x 12 in

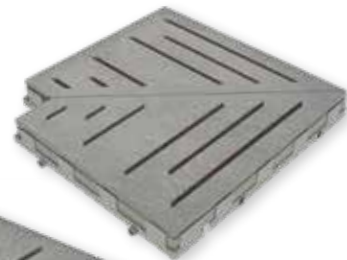

Ceramic channel cover
25 x 50 cm, 10 x 20 in



For details about the Ceramic channel cover, refer to the Pool + Spa programme of delivery.

Floor Tiles¹

30 x 30 cm



30 x 30 cm



30 x 60 cm

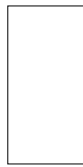

30 x 60 cm



30 x 60 cm



60 x 60 cm

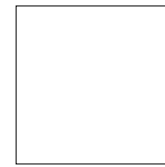

60 x 60 cm

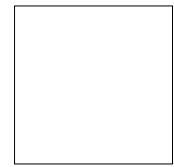

protected

Nom. dim. - cm/in	30 x 30 / 12 x 12	30 x 30 / 12 x 12	30 x 60 / 12 x 24	30 x 60 / 12 x 24	30 x 60 / 12 x 24	60 x 60 / 24 x 24	60 x 60 / 24 x 24
Work size	297 x 297 x 10.5 mm	297 x 297 x 10.5 mm	297 x 597 x 10.5 mm	297 x 597 x 10.5 mm	297 x 597 x 10.5 mm	597 x 597 x 10.5 mm	597 x 597 x 10.5 mm
Surface	structured, matt	relief, matt	smooth, matt	structured, matt	relief, matt	smooth, matt	structured, matt
m ² - pieces	11.110	11.110	5.556	5.556	5.556	2.778	2.778
m ² - kg	23.142	23.142	23.224	23.224	23.224	23.769	23.769
Bundle - pieces	11	11	6	6	6	3	3
Bundle - m ²	0.990	0.990	1.080	1.080	1.080	1.080	1.080
Bundle - kg	22.913	22.913	25.080	25.080	25.080	25.668	25.668
Pallet - m ²	47.525	47.525	43.197	43.197	43.197	38.877	38.877
Pallet - kg	1,099.824	1,099.824	1,003.200	1,003.200	1,003.200	924.048	924.048
Product standard	Bla	Bla	Bla	Bla	Bla	Bla	Bla
Slip resistance	R10/A	R11/B	R9	R10/A	R11/B	R9	R10/A
Stress group	3	3	2	2	2	3	3
deep anthracite	433730 Price gr. A70 (m ²)	433733 Price gr. A70 (m ²)	433402 Price gr. A97 (m ²)	433406 Price gr. A109 (m ²)	433410 Price gr. A109 (m ²)	433660 Price gr. A124 (m ²)	433664 Price gr. A124 (m ²)
light-beige	433732 Price gr. A70 (m ²)	433735 Price gr. A70 (m ²)	433404 Price gr. A97 (m ²)	433408 Price gr. A109 (m ²)	433412 Price gr. A109 (m ²)	433662 Price gr. A124 (m ²)	433666 Price gr. A124 (m ²)
medium grey	433731 Price gr. A70 (m ²)	433734 Price gr. A70 (m ²)	433403 Price gr. A97 (m ²)	433407 Price gr. A109 (m ²)	433411 Price gr. A109 (m ²)	433661 Price gr. A124 (m ²)	433665 Price gr. A124 (m ²)
basalt	433440 Price gr. A70 (m ²)	433442 Price gr. A70 (m ²)	433430 Price gr. A97 (m ²)	433432 Price gr. A109 (m ²)	433434 Price gr. A109 (m ²)	433436 Price gr. A124 (m ²)	433438 Price gr. A124 (m ²)



Stair Tiles^{1/2}

30 x 60 cm

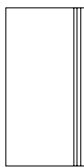

30 x 60 cm



7 x 60 cm



7 x 60 cm



15 x 60 cm



15 x 15 cm



protected

Nom. dim. - cm/in	30 x 60 / 12 x 24	30 x 60 / 12 x 24	7 x 60 / 2 13/16 x 24	7 x 60 / 2 13/16 x 24	15 x 60 / 6 x 24	15 x 15 / 6 x 6
Work size	297 x 597 x 10.5 mm	297 x 597 x 10.5 mm	70 x 597 x 10.5 mm	70 x 597 x 10.5 mm	158 x 597 x 10.5 mm	158 x 158 x 10.5 mm
Surface	smooth, matt	structured, matt	smooth, matt	structured, matt	structured, matt	structured, matt
m - pieces	1.667	1.667	1.667	1.667	1.667	
m - kg	6.968	6.968	1.717	1.717	4.334	
Bundle - pieces	6	6	22	22	4	4
Bundle - m	3.599	3.599	13.197	13.197	2.399	
Bundle - kg	25.080	25.080	22.660	22.660	10.400	6.000
Pallet - m						
Pallet - kg						
Product standard	Bla	Bla	Bla	Bla	Bla	Bla
Slip resistance	R9	R10/A			R10/A	R10/A
Stress group	2	2				
deep anthracite	433850 Price gr. A475 (pce.)	433854 Price gr. A475 (pce.)	433802 Price gr. A434 (m ²)	433806 Price gr. A434 (m ²)		
light-beige	433852 Price gr. A475 (pce.)	433856 Price gr. A475 (pce.)	433804 Price gr. A434 (m ²)	433808 Price gr. A434 (m ²)	432805-HKS Price gr. A573 (pce.)	432805-IE Price gr. A601 (pce.)
mid-grey	433851 Price gr. A475 (pce.)	433855 Price gr. A475 (pce.)	433803 Price gr. A434 (m ²)	433807 Price gr. A434 (m ²)		
basalt	433817 Price gr. A475 (pce.)	433819 Price gr. A475 (pce.)	433821 Price gr. A434 (m ²)	433823 Price gr. A434 (m ²)		



³ Minimum order quantity 50 pieces

⁴ Other colors available on request

⁵ For detail drawings of cove skirting and internal corner, refer to page 536

You will find other cove skirtings on page 201 under the series Emotion Grip. Attention: Color deviation from the rest of the Emotion range, as fine-grain look.



KUBEZ (cultural and meeting centre), Dietach, Austria / Architect: Team M Architekten ZT GesmbH / Photo: Roland Reuter, Absam







R10/A R11/B R11V4 R12 R12V4 R12V8 R13 R13V10



Surfaces: Floor tiles



basalt

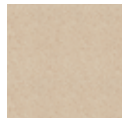

light-beige



deep anthracite

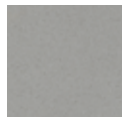

mid-grey

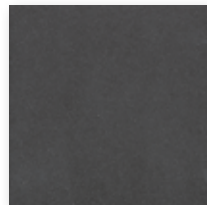

Floor tile 20 x 20 cm, 8 x 8 in, smooth, R10/A
 Floor tile 20 x 20 cm, 8 x 8 in, Softcorn 2, R11/B
 Floor tile 20 x 20 cm, 8 x 8 in, Perlicorn 2, R11V4
 Floor tile 20 x 20 cm, 8 x 8 in, Perlstic, R12
 Floor tile 20 x 20 cm, 8 x 8 in, Carostic, R12V4
 Floor tile 20 x 20 cm, 8 x 8 in, Picstic, R12V8, extra thick
 Floor tile 20 x 20 cm, 8 x 8 in, roughened, R13, extra thick
 Floor tile 20 x 20 cm, 8 x 8 in, Kombicorn, R13V10, extra thick



Floor tile 30 x 30 cm, 12 x 12 in, smooth, R10/A



Stair tile 30 x 30 cm (with grooves), 12 x 12 in, smooth, R10/A

Mosaic

10 x 10 cm, 4 x 4 in

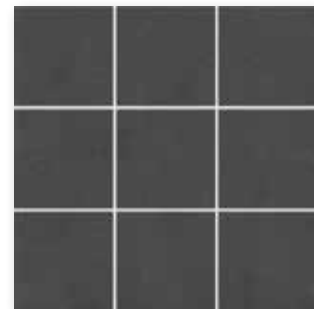

Mosaic sheet 30 x 30 cm, 12 x 12 in, smooth, R10/B



Mosaics glued thermoplastically on back of Agrob Buchtal can be used not only in dry zones but also without any problems in underwater areas (e.g. swimming pools/whirlpools) as well as in permanently wet areas (e.g. pool surrounds/showers).



Skirting with bevel 10 x 20 cm, 4 x 8 in smooth



Cove skirting 10 x 20 cm, 4 x 8 in, smooth, R10/A



Cove skirting 10 x 30 cm, 4 x 12 in, smooth, R10/A



Internal corner for cove skirting, smooth



External corner for cove skirting, smooth



yellow

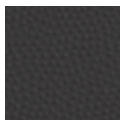

black



Safety triangles, extra thick 27.8 x 20 cm, 11 x 8 in, grained, R11



Laying pattern

Mosaic¹

Wall/Floor Tiles

10 x 10 cm

20 x 20 cm

20 x 20 cm

20 x 20 cm

20 x 20 cm

20 x 20 cm



protected

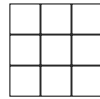

Sheet: 297 x 297 mm

smooth

Softcorn 2

Perlcom 2

Perlstic

Carostic

Nom. dim. - cm/in	10 x 10 / 4 x 4	20 x 20 / 8 x 8	20 x 20 / 8 x 8	20 x 20 / 8 x 8	20 x 20 / 8 x 8	20 x 20 / 8 x 8	20 x 20 / 8 x 8
Work size	97 x 97 x 6.5 mm	197 x 197 x 10.5 mm	197 x 197 x 10.5 mm	197 x 197 x 10.5 mm	197 x 197 x 10.5 mm	197 x 197 x 10.5 mm	197 x 197 x 10.5 mm
Surface	smooth, matt	smooth, matt	structured, matt	fine-grained, matt	fine-grained, matt	fine-grained, matt	profiled, matt
m ² - pieces	11 sheets	25.000	25.000	25.000	25.000	25.000	25.000
m ² - kg	13.101	22.900	22.900	22.900	22.900	22.900	22.900
Bundle - pieces	11 sheets	21	21	21	21	21	21
Bundle - m ²	1.000	0.840	0.840	0.840	0.840	0.840	0.840
Bundle - kg	13.101	19.236	19.236	19.236	19.236	19.236	19.236
Pallet - m ²	64.000	50.400	50.400	50.400	50.400	50.400	50.400
Pallet - kg	838.464	1,154.160	1,154.160	1,154.160	1,154.160	1,154.160	1,154.160
Product standard	Bla	Bla	Bla	Bla	Bla	Bla	Bla
Slip resistance	R10/B	R10/A	R11/B	R11V4	R12	R12V4	R12V4
Stress group	1	3	3	3	3	3	3
deep anthracite <input type="checkbox"/>	435026 Price gr. A148 (m ²)	434216 Price gr. A121 (m ²)	434219 Price gr. A121 (m ²)	434222 Price gr. A154 (m ²)	434225 Price gr. A154 (m ²)	434228 Price gr. A154 (m ²)	
medium grey <input type="checkbox"/>	435027 Price gr. A148 (m ²)	434217 Price gr. A121 (m ²)	434220 Price gr. A121 (m ²)	434223 Price gr. A154 (m ²)	434226 Price gr. A154 (m ²)	434229 Price gr. A154 (m ²)	
light-beige <input type="checkbox"/>	435028 Price gr. A148 (m ²)	434218 Price gr. A121 (m ²)	434221 Price gr. A121 (m ²)	434224 Price gr. A154 (m ²)	434227 Price gr. A154 (m ²)	434230 Price gr. A154 (m ²)	
basalt <input type="checkbox"/>	435029 Price gr. A148 (m ²)	434326 Price gr. A121 (m ²)	434328 Price gr. A121 (m ²)	434330 Price gr. A154 (m ²)	434332 Price gr. A154 (m ²)	434334 Price gr. A154 (m ²)	



Wall/Floor Tiles

Floor Tiles²

30 x 30 cm

20 x 20 cm

20 x 20 cm

20 x 20 cm

20 x 20 cm

20 x 20 cm

20 x 20 cm



protected



smooth

smooth, extra thick

Softcorn 2, extra thick

Perlstic, extra thick

Carostic, extra thick

Picstic, extra thick

Roughened, extra thick

Nom. dim. - cm/in	30 x 30 / 12 x 12	20 x 20 / 8 x 8	20 x 20 / 8 x 8	20 x 20 / 8 x 8	20 x 20 / 8 x 8	20 x 20 / 8 x 8	20 x 20 / 8 x 8
Work size	297 x 297 x 10.5 mm	197 x 197 x 15 mm	197 x 197 x 15 mm	197 x 197 x 15 mm	197 x 197 x 15 mm	197 x 197 x 15 mm	197 x 197 x 15 mm
Surface	smooth, matt	smooth, matt	structured, matt	fine-grained, matt	fine-grained, matt	smooth, matt	profiled, matt
m ² /m - pieces	11.111/m ²	25.767/m ²	25.767/m ²	25.767/m ²	25.767/m ²	25.767/m ²	25.767/m ²
m ² /m - kg	23.144/m ²	34.322/m ²	34.322/m ²	34.322/m ²	34.322/m ²	34.322/m ²	34.322/m ²
Bundle - pieces	11	15	15	15	15	15	15
Bundle - m ² /m	0.990 m ²	0.582 m ²	0.582 m ²	0.582 m ²	0.582 m ²	0.582 m ²	0.582 m ²
Bundle - kg	22.913	19.980	19.980	19.980	19.980	19.980	19.980
Pallet - m ²	47.520	34.928	34.928	34.928	34.928	34.928	34.928
Pallet - kg	1,099.824	1,198.800	1,198.800	1,198.800	1,198.800	1,198.800	1,198.800
Product standard	Bla	Bla	Bla	Bla	Bla	Bla	Bla
Slip resistance	R10/A	R10/A	R11/B	R12	R12V4	R12V8	R13
Stress group	3	4	4	4	4	4	4
deep anthracite <input type="checkbox"/>	434239 Price gr. A100 (m ²)	434231 Price gr. A154 (m ²)	434233 Price gr. A154 (m ²)	434235 Price gr. A166 (m ²)	434237 Price gr. A166 (m ²)	434976 Price gr. A181 (m ²)	434978 Price gr. A181 (m ²)
medium grey <input type="checkbox"/>	434240 Price gr. A100 (m ²)	434232 Price gr. A154 (m ²)	434234 Price gr. A154 (m ²)	434236 Price gr. A166 (m ²)	434238 Price gr. A166 (m ²)	434977 Price gr. A181 (m ²)	434979 Price gr. A181 (m ²)
light-beige <input type="checkbox"/>	434241 Price gr. A100 (m ²)						
basalt <input type="checkbox"/>	434336 Price gr. A100 (m ²)						



² Delivery time on request

Skirting with Bevel Stair Tiles

20 x 20 cm³



Kombicorn,
extra thick

27,8 x 20 cm²



Safety triangles,
extra thick

10 x 20 cm



30 x 30 cm¹

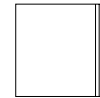

			20 x 20 / 8 x 8	27,8 x 20 / 11 x 8	10 x 20 / 4 x 8	30 x 30 / 12 x 12	Nom. dim. - cm/in
			197 x 197 x 15 mm	278 x 197/197 x 15 mm	97 x 197 x 10.5 mm	297 x 297 x 10.5 mm	Work size
			profiled, matt	fine-grained, matt	smooth, matt	smooth, matt	Surface
			25.767/m ²	3.597/1.798/m	5.000/m	3.333/m	m ² / m - pieces
			34.322/m ²	2.374/1.187/m	2.250/m	6.943/m	m ² / m/pce. - kg
			15	28	20	10	Bundle - pieces
			0.582 m ²	7.784/15.573 m	4.000 m	3.003 m	Bundle - m/m ²
			19.980	18.480	9.000	20.830	Bundle - kg
			34.928				Pallet - m ²
			1,198.800				Pallet - kg
			Bla	Bla	Bla	Bla	Product standard
			R13V10	R11			Slip resistance
			4	4		3	Stress group
			434980		434248	434251	deep anthracite <input type="checkbox"/>
			Price gr. A181 (m ²)		Price gr. A416 (pce.)	Price gr. A449 (pce.)	
			434981		434249	434252	medium grey <input type="checkbox"/>
			Price gr. A181 (m ²)		Price gr. A416 (pce.)	Price gr. A449 (pce.)	
					434250	434253	light-beige <input type="checkbox"/>
					Price gr. A416 (pce.)	Price gr. A449 (pce.)	
					434342	434344	basalt <input type="checkbox"/>
					Price gr. A416 (pce.)	Price gr. A449 (pce.)	
				431321			yellow <input type="checkbox"/>
				Price gr. A416 (pce.)			
				431320			black <input type="checkbox"/>
				Price gr. A416 (pce.)			



Cove Skirting^{4/6}

10 x 20 cm



10 x 30 cm



Internal Corner for Cove Skirting^{4/5}



External Corner for Cove Skirting^{4/5}



			10 x 20 / 4 x 8	10 x 30 / 4 x 12	102 x 20 / 9 mm	102 x 35 / 9 mm	Nom. dim. - cm/in
			102 x 197 x 9 mm	102 x 297 x 9 mm	102 x 20 x 9 mm	102 x 35 x 9 mm	Work size
			smooth, matt	smooth, matt	smooth, matt	smooth, matt	Surface
			5.000	3.333			m - pieces
			2.000/m	2.000/m	0.080/piece	0.080/piece	m/pce. - kg
			20	16	18	12	Bundle - pieces
			4.000	4.801			Bundle - m
			8.000	9.600			Bundle - kg
							Pallet - m
							Pallet - kg
			Bla	Bla	Bla	Bla	Product standard
			R10/A	R10/A			Slip resistance
			432027	432033	432039	432045	deep anthracite <input type="checkbox"/>
			Price gr. A419 (pce.)	Price gr. A425 (pce.)	Price gr. A418 (pce.)	Price gr. A418 (pce.)	
			432028	432034	432040	432046	medium grey <input type="checkbox"/>
			Price gr. A419 (pce.)	Price gr. A425 (pce.)	Price gr. A418 (pce.)	Price gr. A418 (pce.)	
			432029	432035	432041	432047	light-beige <input type="checkbox"/>
			Price gr. A419 (pce.)	Price gr. A425 (pce.)	Price gr. A418 (pce.)	Price gr. A418 (pce.)	
			432030	432036	432042	432048	basalt <input type="checkbox"/>
			Price gr. A419 (pce.)	Price gr. A425 (pce.)	Price gr. A418 (pce.)	Price gr. A418 (pce.)	



² Specification of the logistical data for single-row or double-row installation

³ Delivery time on request

⁴ For details, refer to page 536

⁵ Fitting to cove skirting 10 x 20 / 10 x 30 cm

⁶ Color deviations compared to the adjoining covering due to production are no reason for complaint in case of horizontal laying.





Luxurious and harmonious

Whether in combination with natural materials, pastel colors or metal: Evalia adapts to individual home ideas and adds a tasteful, luxurious touch. The large-format R9 floor tiles in grey, beige and anthracite harmonize with the wall tiles in grey beige matt or glossy. Likewise in grey-beige: the Shino decorative element measuring 30 x 60 cm and the R10/B mosaic in 5 x 5 cm whose similar look and feel inject some dynamism into the design. Wall tiles, decorations and mosaics are easy to clean thanks to the Hytect surface. The range of tiles is rounded off by skirtings.

Rendering

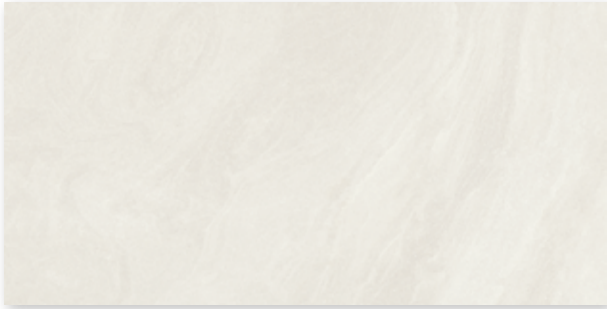

Wall tile 30 x 60 cm, 12 x 24 in, grey beige, smooth

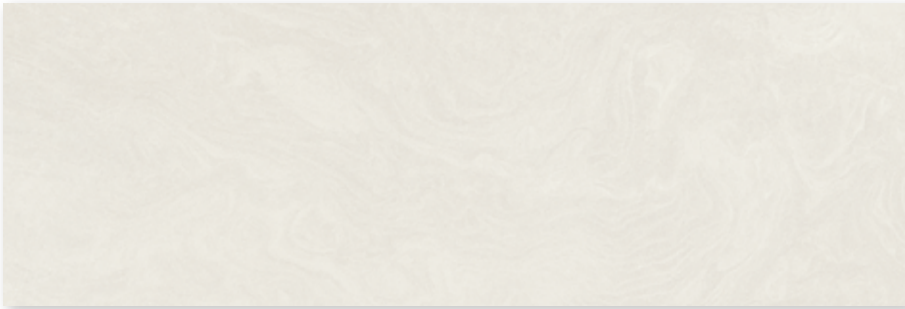

Wall tile 30 x 90 cm, 12 x 36 in, grey beige, smooth

Decoration Elements



Decorative tile Shino 30 x 60 cm, 12 x 24 in, grey beige, smooth

Decoration Elements



Decorative tile Shino 30 x 90 cm, 12 x 36 in, grey beige, smooth

Color deviations are possible and represent a component of the design. The decoration you have chosen is a high-quality glazed earthenware product with a particularly impressive and realistic stone look. The decoration comprises various individual pictures, whose connections are consciously freely designed. Accordingly, individual tiles do not create a continuous design.



grey

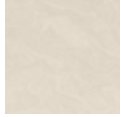

beige



anthracite



Floor tile 60 x 60 cm, 24 x 24 in, smooth, R9



Skirting, rounded 7 x 60 cm, 2 13/16 x 24 in, smooth

Mosaic 5 x 5 cm, 2 x 2 in

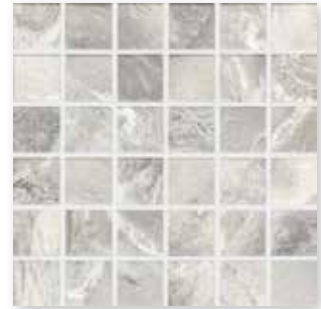

Mosaic sheet Shino 30 x 30 cm, 12 x 12 in
grey beige, smooth, R10/B



Mosaics glued thermoplastically on back of Agrob Buchtal can be used not only in dry zones but also without any problems in underwater areas (e.g. swimming pools/whirlpools) as well as in permanently wet areas (e.g. pool surrounds/showers).

Wall Tiles

Decoration Elements^{4/5}

30 x 60 cm¹



30 x 60 cm¹



30 x 90 cm²

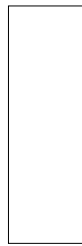

30 x 90 cm²

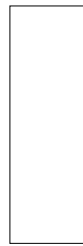

30 x 60 cm¹



30 x 90 cm²



	30 x 60 / 12 x 24	30 x 60 / 12 x 24	30 x 90 / 12 x 36	30 x 90 / 12 x 36	Shino 30 x 60 / 12 x 24	Shino 30 x 90 / 12 x 36	
	297 x 597 x 9 mm	297 x 597 x 9 mm	297 x 897 x 10.5 mm	297 x 897 x 10.5 mm	297 x 597 x 9 mm	297 x 897 x 10.5 mm	Nom. dim. - cm/in
	smooth, glossy	smooth, silky-matt	smooth, glossy	smooth, silky-matt	smooth, glossy	smooth, glossy	Work size
	5.556	5.556	3.704	3.704	5.556	3.704	Surface
	15.279	15.279	17.976	17.976	15.279	17.976	m ² - pieces
	9	9	5	5	9	5	m ² - kg
	1.620	1.620	1.350	1.350	1.620	1.350	Bundle - pieces
	24.750	24.750	24.265	24.265	24.750	24.265	Bundle - m ²
	77.754	77.754	32.397	32.397	77.754	32.397	Bundle - kg
	1,188.000	1,188.000	582.360	582.360	1,188.000	582.360	Pallet - m ²
	BIII	BIII	BIII	BIII	BIII	BIII	Pallet - kg
	283102HR	283126HR	393104H	393127H			Product standard
	Price gr. C122 (m ²)	Price gr. C122 (m ²)	Price gr. C149 (m ²)	Price gr. C149 (m ²)			grey beige V2
					283103HR	393105H	grey beige V4
					Price gr. C128 (m ²)	Price gr. C155 (m ²)	

Mosaic^{3/6}

Floor Tiles¹

Skirting, rounded¹

5 x 5 cm



60 x 60 cm

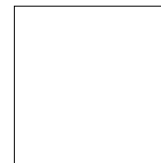

7 x 60 cm



protected

				Shino Sheet: 297 x 297 mm	5 x 5 / 2 x 2	60 x 60 / 24 x 24	7 x 60 / 2 13/16 x 24	
					47 x 47 x 6.5 mm	595 x 595 x 9.5 mm	70 x 595 x 9.5 mm	Nom. dim. - cm/in
					smooth, matt	smooth, semi-polished	smooth, semi-polished	Work size
					11 sheets	2.778/m ²	1.667/m	Surface
					12.331/m ²	21.112/m ²	1.470/m	m ² - pieces
					11 sheets	4	15	m ² - kg
					1.000 m ²	1.440 m ²	8.998 m	Bundle - pieces
					12.331	30.400	13.230	Bundle - m ²
					64.000	46.076		Bundle - kg
					789.184	972.800		Pallet - m ²
					Bla	Bla	Bla	Pallet - kg
					R10/B	R9		Product standard
					1	2		Slip resistance
					431919H			Stress group
					Price gr. C230 (m ²)			grey beige V4
						431913	431920	grey V3
						Price gr. C155 (m ²)	Price gr. C440 (pce.)	beige V3
						431914	431921	anthracite V3
						Price gr. C155 (m ²)	Price gr. C440 (pce.)	
						431915	431922	
						Price gr. C155 (m ²)	Price gr. C440 (pce.)	

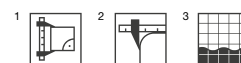

⁴ The decoration consists of different individual pictures. The connections of the individual pictures are deliberately designed freely and thus do not connect in the continuous laying. The composition of the motifs in the box may vary due to production reasons.

⁵ Decoration elements only available in full boxes.

⁶ without Protecta upgrading; with Hytect coating





Authentic surface

The Factory series ceramically transforms lived-in concrete floors into a lively and uncomplicated covering. In combination with classic ornamental accents, the result is a series which combines the style worlds of Industrial & Modern Country in a cosy way. Color shades from both worlds round off the concept and cater to individual design preferences. Factory also includes Circle, a versatile decorative element for walls and floors, which sets accents without appearing fashionable or dominant. All products are Hytect-coated and therefore particularly easy to clean.

Rendering

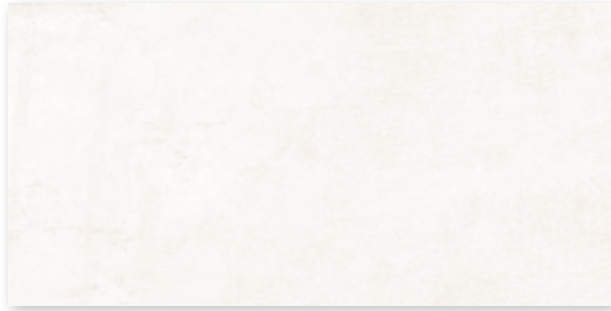

Wall tile 30 x 60 cm, 12 x 24 in, cotton, structured



Wall tile 30 x 60 cm, 12 x 24 in, smoke white, structured

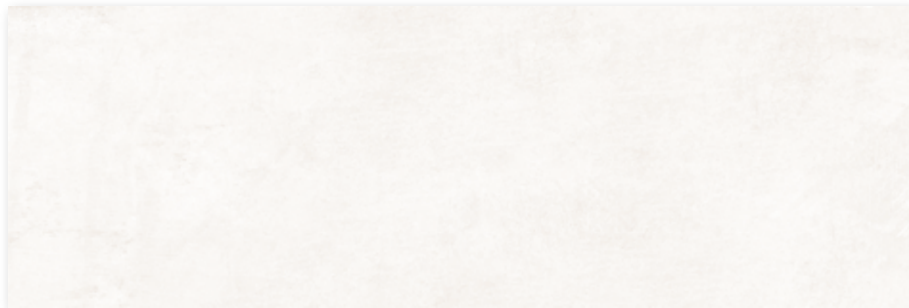

Wall tile 30 x 90 cm, 12 x 36 in, cotton, structured



Wall tile 30 x 90 cm, 12 x 36 in, smoke white, structured

Decoration Elements

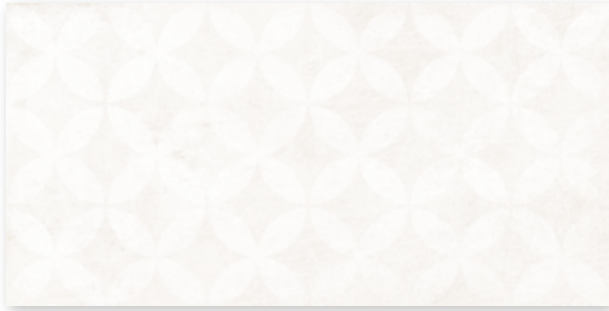

Decorative tile Circle 30 x 60 cm, 12 x 24 in, cotton, structured



Decorative tile Circle 30 x 60 cm, 12 x 24 in, smoke white, structured



Decorative tile Circle 30 x 90 cm, cotton, structured



Decorative tile Circle 30 x 90 cm, smoke white, structured



lime

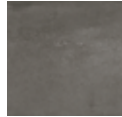

bronze grey



aluminium



asphalt

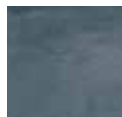

blue steel



Floor tile 30 x 60 cm, 12 x 24 in, structured, R10/A+B

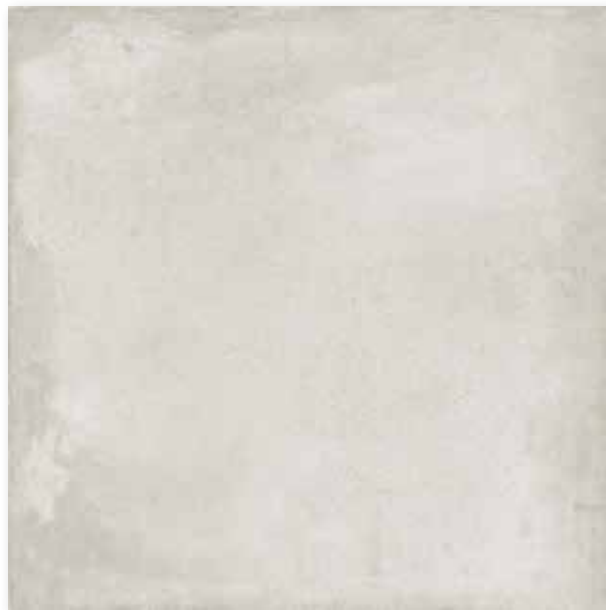

Floor tile 60 x 60 cm, 24 x 24 in, structured, R10/A+B



Floor tile 60 x 120 cm, 24 x 48 in, structured, R10/A+B

Mosaic 5 x 5 cm, 2 x 2 in



Mosaic sheet 30 x 30 cm, 12 x 12 in, structured, R10/A+B

Mosaic: Glass fibre net on reverse side, sheet: 297 x 297 mm



R11/B R10/A+B



Decoration Elements



Floor decor Circle 60 x 60 cm, 24 x 24 in, structured, R10/A+B



Patio tile 60 x 60 cm, 24 x 24 in, structured, R11/B



Skirting, rounded 7 x 60 cm, 2 13/16 x 24 in, structured



Stair tile 30 x 120 cm, 12 x 48 in, (with grooves), structured, R10/A+B

Wall Tiles

Decoration Elements²

30 x 60 cm



30 x 90 cm¹

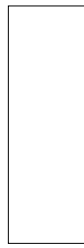

30 x 60 cm



30 x 90 cm¹



Circle

Circle

Nom. dim. - cm/in	30 x 60 / 12 x 24	30 x 90 / 12 x 36	30 x 60 / 12 x 24	30 x 90 / 12 x 36			
Work size	297 x 597 x 6 mm	297 x 897 x 6 mm	297 x 597 x 6 mm	297 x 897 x 6 mm			
Surface	structured, stone-matt	structured, stone-matt	structured, stone-matt	structured, stone-matt			
m ² - pieces	5.556	3.704	5.556	3.704			
m ² - kg	10.279	10.400	10.279	10.400			
Bundle - pieces	13	8	13	8			
Bundle - m ²	2.340	2.160	2.340	2.160			
Bundle - kg	24.050	22.464	24.050	22.464			
Pallet - m ²	112.311	51.836	112.311	51.836			
Pallet - kg	1,154.400	539.136	1,154.400	539.136			
Product standard	BIII	BIII	BIII	BIII			
	203479H	323485H	203481H	323483H			
cotton V2	Price gr. C107 (m ²)	Price gr. C149 (m ²)	Price gr. C116 (m ²)	Price gr. C155 (m ²)			
	203480H	323486H	203482H	323484H			
smoke white V2	Price gr. C107 (m ²)	Price gr. C149 (m ²)	Price gr. C116 (m ²)	Price gr. C155 (m ²)			



² Decoration elements only available in full boxes.

Mosaic^{1/2}

Floor Tiles¹

Decoration Elements¹

5 x 5 cm



30 x 60 cm

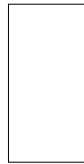

60 x 60 cm



60 x 120 cm^{3/4}

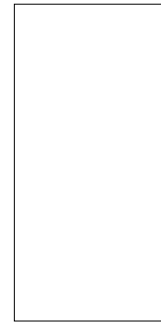

60 x 60 cm

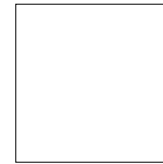

Sheet: 297 x 297 mm

Floor decor Circle

	5 x 5 / 2 x 2	30 x 60 / 12 x 24	60 x 60 / 24 x 24	60 x 120 / 24 x 48	60 x 60 / 24 x 24	Nom. dim. - cm/in
	47 x 47 x 9 mm	297 x 597 x 9 mm	597 x 597 x 9 mm	597 x 1197 x 9 mm	597 x 597 x 9 mm	Work size
	structured, matt	structured, matt	structured, matt	structured, matt	structured, matt	Surface
	11.111 sheets	5.556	2.778	1.389	2.778	m ² - pieces
	19.833	19.907	20.371	21.132	20.371	m ² - kg
	12 sheets	7	3	2	3	Bundle - pieces
	1.080	1.260	1.080	1.441	1.080	Bundle - m ²
	21.420	25.081	21.999	30.450	21.999	Bundle - kg
	32.400	50.396	45.356	50.432	45.356	Pallet - m ²
	642.600	1,003.240	923.958	1,065.750	923.958	Pallet - kg
	Bla	Bla	Bla	Bla	Bla	Product standard
	R10/A+B	R10/A+B	R10/A+B	R10/A+B	R10/A+B	Slip resistance
	2	2	2	2	2	Stress group
	435901H	435906H	435911H	435916H	435921H	lime <input type="checkbox"/> V3
	Price gr. C293 (m ²)	Price gr. C125 (m ²)	Price gr. C140 (m ²)	Price gr. C152 (m ²)	Price gr. C149 (m ²)	
	435902H	435907H	435912H	435917H	435922H	bronze grey <input type="checkbox"/> V3
	Price gr. C293 (m ²)	Price gr. C125 (m ²)	Price gr. C140 (m ²)	Price gr. C152 (m ²)	Price gr. C149 (m ²)	
	435903H	435908H	435913H	435918H	435923H	aluminium <input type="checkbox"/> V3
	Price gr. C293 (m ²)	Price gr. C125 (m ²)	Price gr. C140 (m ²)	Price gr. C152 (m ²)	Price gr. C149 (m ²)	
	435904H	435909H	435914H	435919H	435924H	asphalt <input type="checkbox"/> V3
	Price gr. C293 (m ²)	Price gr. C125 (m ²)	Price gr. C140 (m ²)	Price gr. C152 (m ²)	Price gr. C149 (m ²)	
	435905H	435910H	435915H	435920H	435925H	blue steel <input type="checkbox"/> V3
	Price gr. C293 (m ²)	Price gr. C125 (m ²)	Price gr. C140 (m ²)	Price gr. C152 (m ²)	Price gr. C149 (m ²)	



- ¹
- ² Glass fibre net on reverse side
- ³ Please note: special pallet. No return, no exchange.
- ⁴ High weight only to carry with two persons.



Stair Tile^{1/2}

Skirting, rounded¹

Patio Tile^{1/3}

30 x 120 cm

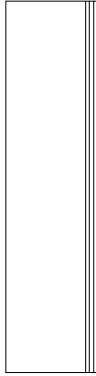

7 x 60 cm



60 x 60 cm

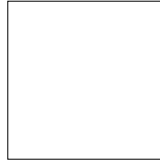

Nom. dim. - cm/in	30 x 120 / 12 x 48	7 x 60 / 2 13/16 x 24	60 x 60 / 24 x 24				
Work size	297 x 1197 x 9 mm	70 x 597 x 9 mm	597 x 597 x 20 mm				
Surface	structured, matt	structured, matt	structured, matt				
m ² /m - pieces	0.833/m	1.667/m	2.778/m ²				
m ² /m - kg	6.341/m	1.357/m	45.273/m ²				
Bundle - pieces	3	15	2				
Bundle - m ² /m	3.601 m	8.998 m	0.720 m ²				
Bundle - kg	22.836	12.210	32.594				
Pallet - m ²			21.598				
Pallet - kg			977.820				
Product standard	Bla	Bla	Bla				
Slip resistance	R10/A+B		R11/B				
Stress group	2		4				
lime	435930H Price gr. C517 (pce.)	435935H Price gr. C440 (pce.)	435926H Price gr. C200 (m ²)				
bronze grey	435931H Price gr. C517 (pce.)	435936H Price gr. C440 (pce.)	435927H Price gr. C200 (m ²)				
aluminium	435932H Price gr. C517 (pce.)	435937H Price gr. C440 (pce.)	435928H Price gr. C200 (m ²)				
asphalt	435933H Price gr. C517 (pce.)	435938H Price gr. C440 (pce.)	435929H Price gr. C200 (m ²)				
blue steel	435934H Price gr. C517 (pce.)	435939H Price gr. C440 (pce.)					



³ High weight only to carry with two persons.







Innovative and robust

Specialists achieve more. This also applies to the ceramic floor tiles of the Ferrum series, which were specially developed for the tough requirements of industrial plants. The integrally colored, unglazed split tiles are particularly slip-resistant and thus prevent accidents at work. They are extremely robust and exceed the compressive strength of concrete or coating materials many times over. A technically sophisticated range of accessories, which includes cove skirtings and gutter tiles, facilitates the realization of company-specific complete solutions.

Education and Research Institute for Wine- and Fruit-growing,
Weinsberg, Germany / Architect: Staatl. Hochbauamt / Photo: Andreas Freytag

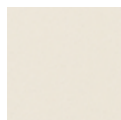

grey beige



grey-white



stone-grey

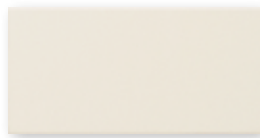

Floor tile 12.5 x 25 cm, 5 x 10 in, smooth, R10/A
Floor tile 12.5 x 25 cm, 5 x 10 in, smooth, R11/B



Cove skirting, r = 20 mm
12.5 x 25 cm, smooth

Mitred pair,
smooth

Terminal piece,
smooth



Gutter tile, smooth

Gutter tile with outlet 1½", smooth

Floor Tiles

Skirtings¹

12.5 x 25 cm



12.5 x 25 cm



25 x 12.5 cm



11 mm thick

20 mm thick

r= 20 mm

				11 mm thick	20 mm thick	r= 20 mm	
				1100	1110	4035	Model number
				12.5 x 25 / 5 x 10	12.5 x 25 / 5 x 10	12.5 x 25 / 5 x 10	Nom. dim. - cm/in
				115 x 240 x 11 mm	115 x 240 x 20 mm	125/9 x 240 x 11 mm	Work size
				smooth, matt	smooth, matt	smooth, matt	Surface
				33.000/m ²	33.000/m ²	4.000/m	m ² /m - pieces
				22.869/m ²	41.679/m ²	3.420/m	m ² /m - kg
				23	13	18	Bundle - pieces
				0.697 m ²	0.394 m ²	4.500 m	Bundle - m ² /m
				15.939	16.419	15.390	Bundle - kg
				58.545	33.091		Pallet - m ²
				1,338.876	1.379.196		Pallet - kg
				Alb	Alb	Alb	Product standard
				siehe unten	siehe unten	siehe unten	Slip resistance
				2	4		Stress group
				R10/A	R10/A		
				900R-1100	900R-1110	<i>900R-4035</i>	grey beige <input type="checkbox"/> VO
				Price gr. A115 (m ²)	Price gr. A211 (m ²)	Price gr. <i>A434</i> (pce.)	
				R11/B	R11/B		
				902R-1100	902R-1110	<i>902R-4035</i>	grey-white <input type="checkbox"/> VO
				Price gr. A115 (m ²)	Price gr. A211 (m ²)	Price gr. <i>A434</i> (pce.)	
				R11/B	R11/B		
				929R-1100	929R-1110	<i>929R-4035</i>	stone-grey <input type="checkbox"/> VO
				Price gr. A115 (m ²)	Price gr. A211 (m ²)	Price gr. <i>A434</i> (pce.)	



Gutter Tiles (trough depth 15 mm)

25 x 15.6 cm

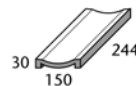

25 x 15.6 cm²

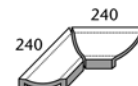

25 x 15.6 cm



Gutter tile

Gutter tile with outlet 1 1/2"

Gutter tile, mitred pair

Gutter tile, terminal piece

				54420	54421	54422	54423
				25 x 15.6 / 10 x 6 1/4	25 x 15.6 / 10 x 6 1/4		25 x 15.6 / 10 x 6 1/4
				244 x 150 x 30 mm	244 x 150 x 30 mm	(2x) 240 x 150 x 30 mm	244 x 150 x 30 mm
				smooth, matt	smooth, matt	smooth, matt	smooth, matt
				4.000			
				1.800/piece	1.530/piece	3.030/pair	1.950/piece
				8 piece	8 piece	4 pair	8 piece
				2.000			
				14.400	12.240	12.120	15.600
				Alb	Alb	Alb	Alb
				R10/A	R10/A	R10/A	R10/A
				900-54420	900-54421	900-54422	900-54423
				Price gr. A458 (pce.)	Price gr. A560 (pce.)	Price gr. A581 (pair)	Price gr. A560 (pce.)



¹ Fitting insert for the outlet: Art. no. 182 - Programme of delivery Pool + Spa 2025 (installation prior to laying)

Nosing tiles in the size of 12.5 x 25 cm can be produced with glued edge on request. The price is calculated project-specifically.

No pallet rebate is granted for the gutter tiles. Surface to be treated with a suitable impregnation agent! See page 527 in the Technical Information.







Fresh and modern

Fresh offers a harmonious range of modern, fresh colors in the popular mosaic formats of 2.5 x 2.5 cm and 5 x 5 cm, with which individual, but at the same time uncomplicated to realize designs are possible. A particularly practical advantage is that R10/B and R11/C slip-resistant mosaics in colors matching the tiles are available.

Rendering

Fresh: modern clarity for individual design

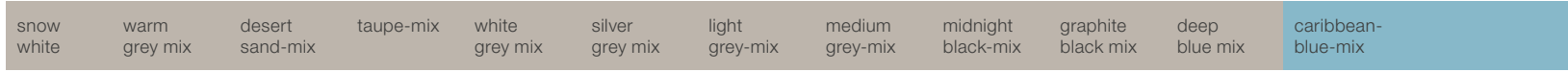

2.5 x 2.5 cm, 1 x 1 in

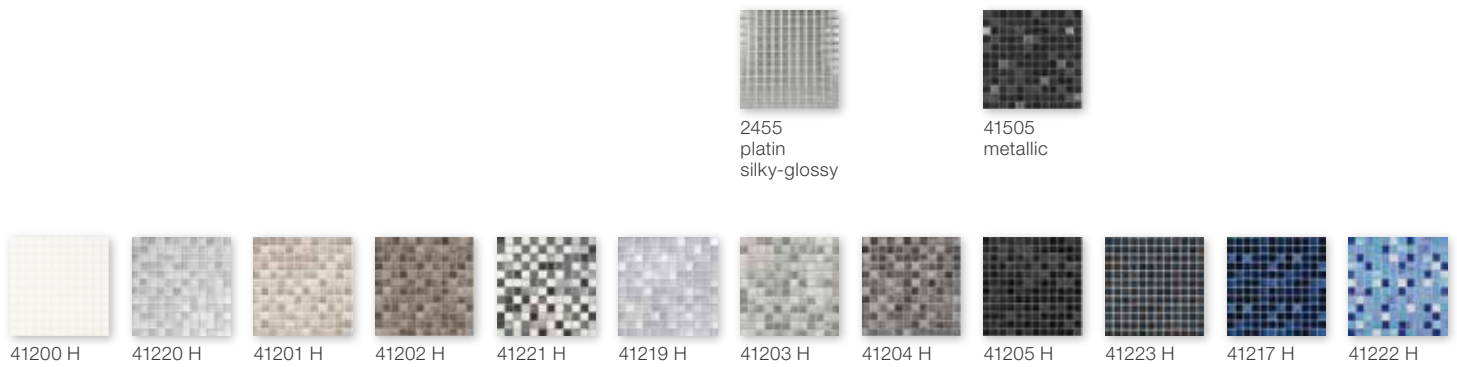

2.5 x 2.5 cm, 1 x 1 in, non-slip R10/B



5 x 5 cm, 2 x 2 in, non-slip R10/B & R11/C



denim blue-mix	light blue-mix	pacific blue-mix	midnight blue-mix	vivid violet-mix	sunset orange-mix	coral red-mix	brick red mix	mystic red-mix	forest green mix	lime green-mix	sunshine yellow-mix
----------------	----------------	------------------	-------------------	------------------	-------------------	---------------	---------------	----------------	------------------	----------------	---------------------

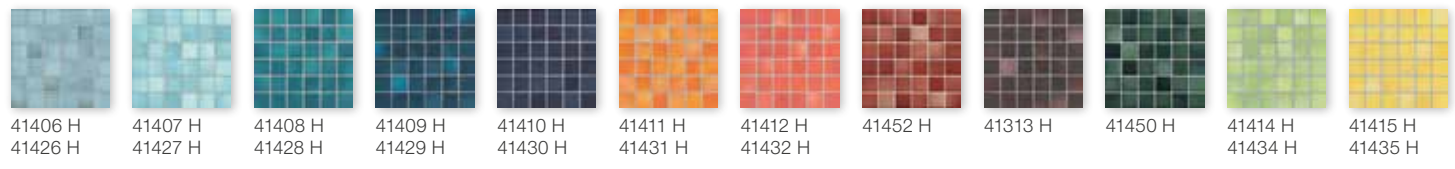
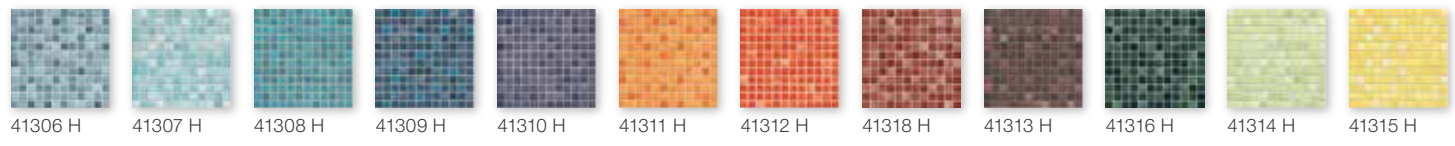
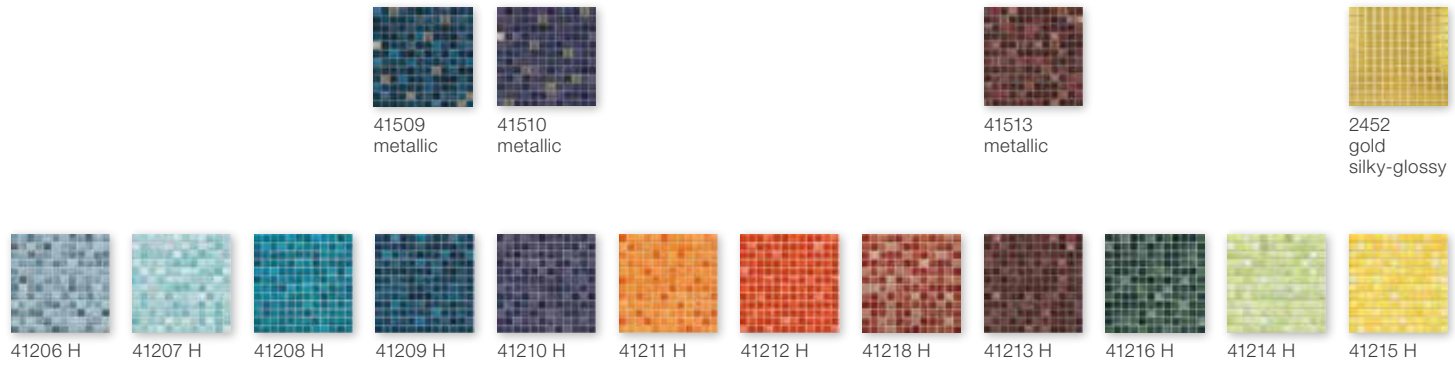

Mosaic 2.5 x 2.5 cm, 1 x 1 in



Mosaic sheet 30 x 30 cm, 12 x 12 in snow white, smooth,
Mosaic sheet 30 x 30 cm, 12 x 12 in snow white, smooth, R10/B

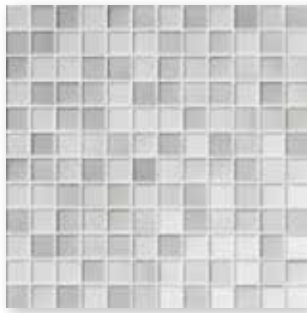

Mosaic sheet 30 x 30 cm, 12 x 12 in warm grey-mix, smooth,
Mosaic sheet 30 x 30 cm, 12 x 12 in warm grey-mix, smooth, R10/B



Mosaic sheet 30 x 30 cm, 12 x 12 in desert sand-mix, smooth,
Mosaic sheet 30 x 30 cm, 12 x 12 in desert sand-mix, smooth, R10/B



Mosaic sheet 30 x 30 cm, 12 x 12 in taupe-mix, smooth,
Mosaic sheet 30 x 30 cm, 12 x 12 in taupe-mix, smooth, R10/B



Mosaic sheet 30 x 30 cm, 12 x 12 in white grey-mix, smooth,
Mosaic sheet 30 x 30 cm, 12 x 12 in white grey-mix, smooth, R10/B

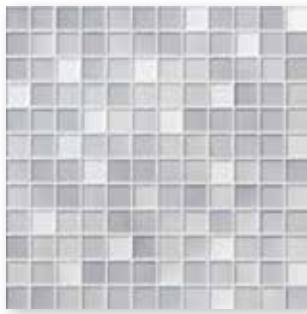

Mosaic sheet 30 x 30 cm, 12 x 12 in silver grey-mix, smooth,
Mosaic sheet 30 x 30 cm, 12 x 12 in silver grey-mix, smooth, R10/B

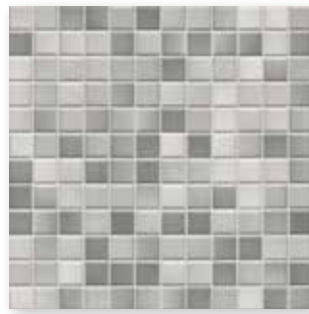

Mosaic sheet 30 x 30 cm, 12 x 12 in light grey-mix, smooth,
Mosaic sheet 30 x 30 cm, 12 x 12 in light grey-mix, smooth, R10/B

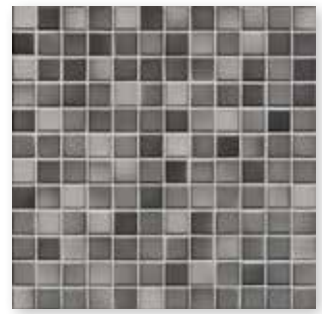

Mosaic sheet 30 x 30 cm, 12 x 12 in medium grey-mix, smooth,
Mosaic sheet 30 x 30 cm, 12 x 12 in medium grey-mix, smooth, R10/B

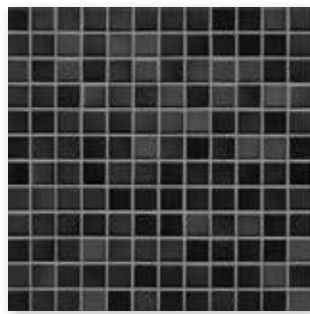

Mosaic sheet 30 x 30 cm, 12 x 12 in midnight black-mix, smooth,
Mosaic sheet 30 x 30 cm, 12 x 12 in midnight black-mix, smooth, R10/B

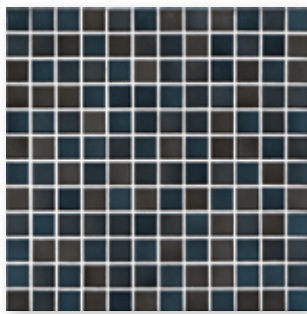

Mosaic sheet 30 x 30 cm, 12 x 12 in graphite black-mix, smooth,
Mosaic sheet 30 x 30 cm, 12 x 12 in graphite black-mix, smooth, R10/B

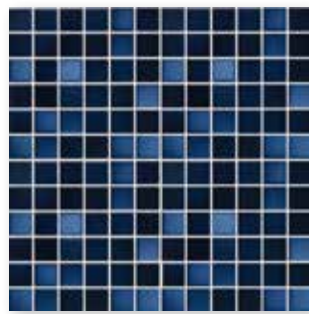

Mosaic sheet 30 x 30 cm, 12 x 12 in deep blue-mix, smooth,
Mosaic sheet 30 x 30 cm, 12 x 12 in deep blue-mix, smooth, R10/B

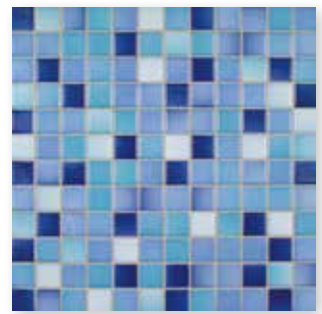

Mosaic sheet 30 x 30 cm, 12 x 12 in caribbean-blue-mix, smooth,
Mosaic sheet 30 x 30 cm, 12 x 12 in caribbean-blue-mix, smooth, R10/B

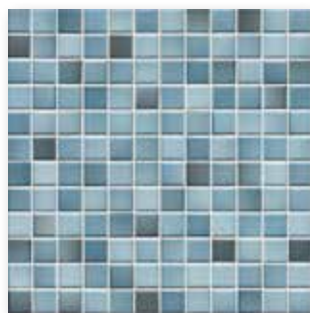

Mosaic sheet 30 x 30 cm, 12 x 12 in denim blue-mix, smooth,
Mosaic sheet 30 x 30 cm, 12 x 12 in denim blue-mix, smooth, R10/B



Mosaic sheet 30 x 30 cm, 12 x 12 in light blue-mix, smooth,
Mosaic sheet 30 x 30 cm, 12 x 12 in light blue-mix, smooth, R10/B

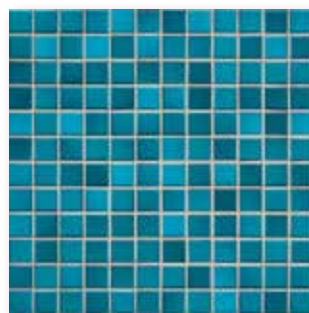

Mosaic sheet 30 x 30 cm, 12 x 12 in pacific blue-mix, smooth,
Mosaic sheet 30 x 30 cm, 12 x 12 in pacific blue-mix, smooth, R10/B



Mosaic sheet 30 x 30 cm, 12 x 12 in midnight blue-mix, smooth,
Mosaic sheet 30 x 30 cm, 12 x 12 in midnight blue-mix, smooth, R10/B



Mosaic sheet 30 x 30 cm, 12 x 12 in vivid violet-mix, smooth,
Mosaic sheet 30 x 30 cm, 12 x 12 in vivid violet-mix, smooth, R10/B

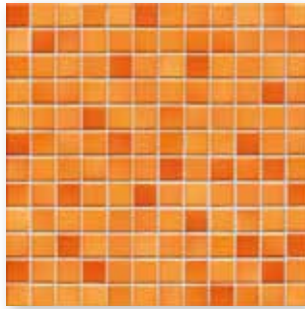

Mosaic sheet 30 x 30 cm, 12 x 12 in sunset-orange-mix, smooth,
Mosaic sheet 30 x 30 cm, 12 x 12 in sunset-orange-mix, smooth, R10/B

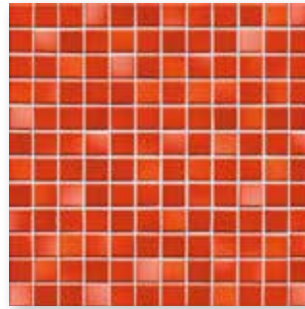

Mosaic sheet 30 x 30 cm, 12 x 12 in coral red-mix, smooth,
Mosaic sheet 30 x 30 cm, 12 x 12 in coral red-mix, smooth, R10/B

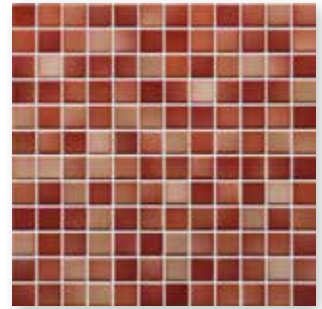

Mosaic sheet 30 x 30 cm, 12 x 12 in brick red-mix, smooth,
Mosaic sheet 30 x 30 cm, 12 x 12 in brick red-mix, smooth, R10/B

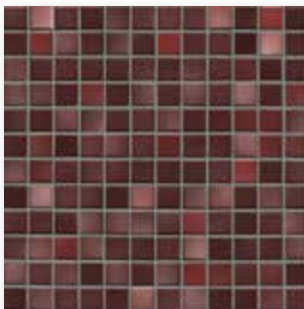

Mosaic sheet 30 x 30 cm, 12 x 12 in mystic-red-mix, smooth,
Mosaic sheet 30 x 30 cm, 12 x 12 in mystic-red-mix, smooth, R10/B



Mosaic sheet 30 x 30 cm, 12 x 12 in forest green-mix, smooth,
Mosaic sheet 30 x 30 cm, 12 x 12 in forest green-mix, smooth, R10/B



Mosaic sheet 30 x 30 cm, 12 x 12 in lime green-mix, smooth,
Mosaic sheet 30 x 30 cm, 12 x 12 in lime green-mix, smooth, R10/B

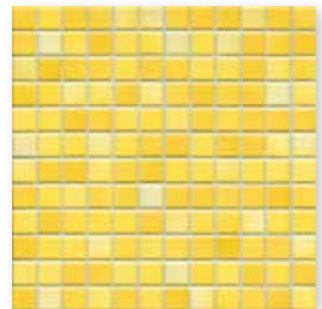

Mosaic sheet 30 x 30 cm, 12 x 12 in sunshine yellow-mix, smooth,
Mosaic sheet 30 x 30 cm, 12 x 12 in sunshine yellow-mix, smooth, R10/B

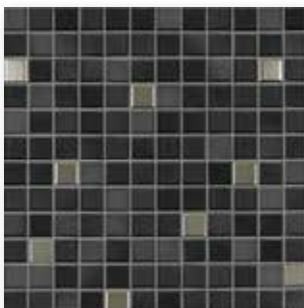

Mosaic sheet 30 x 30 cm, 12 x 12 in midnight black-mix metallic, smooth



Mosaic sheet 30 x 30 cm, 12 x 12 in midnight blue-mix metallic, smooth

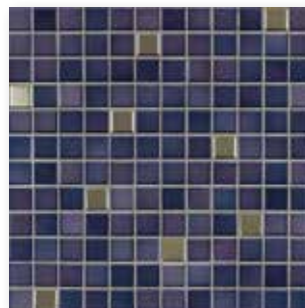

Mosaic sheet 30 x 30 cm, 12 x 12 in vivid violet-mix metallic, smooth

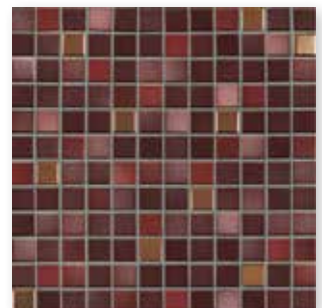

Mosaic sheet 30 x 30 cm, 12 x 12 in mystic red-mix metallic, smooth

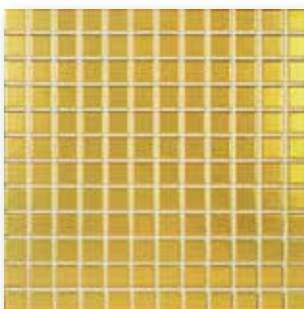

Mosaic sheet 30 x 30 cm, 12 x 12 in, gold, smooth *

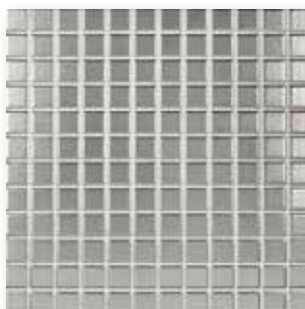

Mosaic sheet 30 x 30 cm, 12 x 12 in, platin, smooth *

* To prevent the abrasion of the surface coating, laying on the floor or exposure to any comparable stress must be absolutely avoided.



Mosaics glued thermoplastically on back of Agrob Buchtal can be used not only in dry zones but also without any problems in underwater areas (e.g. swimming pools/whirlpools) as well as in permanently wet areas.

Indoor swimming pool, Oberuzwil, Switzerland / Architect: Hunziker Betatech AG / Photo: Adriano Faragulo



Color gradient
2.5 x 2.5 cm, 1 x 1 in



41520H
aqua glossy

production size without external joint:
297 x 2376 x 6.5 mm

More examples

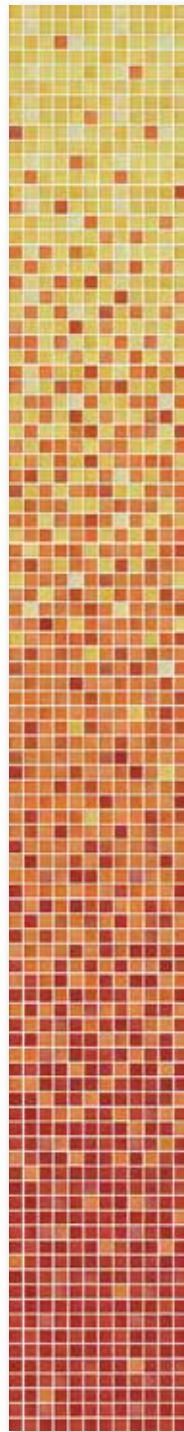

The colors of Fresh can be randomly replaced in the standard color gradient without extra charge. We will be pleased to check an individual design of color gradients with regard to dimensions and color combinations as customized production.

Do you already know our Mosaic Designer at our website www.agrob-buchtal.com?

There, you will have the possibility of designing your individual color gradients, mosaic compositions and the laying of pictures.



Mosaic 5 x 5 cm, 2 x 2 in, non-slip



Mosaic sheet 30 x 30 cm, 12 x 12 in snow white, smooth, R10/B,
Mosaic sheet 30 x 30 cm, 12 x 12 in snow white, smooth, R11/C



Mosaic sheet 30 x 30 cm, 12 x 12 in warm grey-mix, smooth, R10/B,
Mosaic sheet 30 x 30 cm, 12 x 12 in warm grey-mix, smooth, R11/C



Mosaic sheet 30 x 30 cm, 12 x 12 in desert sand-mix, smooth, R10/B,
Mosaic sheet 30 x 30 cm, 12 x 12 in desert sand-mix, smooth, R11/C



Mosaic sheet 30 x 30 cm, 12 x 12 in taupe-mix, smooth, R10/B,
Mosaic sheet 30 x 30 cm, 12 x 12 in taupe-mix, smooth, R11/C



Mosaic sheet 30 x 30 cm, 12 x 12 in white grey-mix, smooth, R10/B



Mosaic sheet 30 x 30 cm, 12 x 12 in silver grey-mix, smooth, R10/B



Mosaic sheet 30 x 30 cm, 12 x 12 in light grey-mix, smooth, R10/B,
Mosaic sheet 30 x 30 cm, 12 x 12 in light grey-mix, smooth, R11/C



Mosaic sheet 30 x 30 cm, 12 x 12 in medium grey-mix, smooth, R10/B,
Mosaic sheet 30 x 30 cm, 12 x 12 in medium grey-mix, smooth, R11/C



Mosaic sheet 30 x 30 cm, 12 x 12 in midnight black-mix, smooth, R10/B,
Mosaic sheet 30 x 30 cm, 12 x 12 in midnight black-mix, smooth, R11/C



Mosaic sheet 30 x 30 cm, 12 x 12 in graphite black-mix, smooth, R10/B



Mosaic sheet 30 x 30 cm, 12 x 12 in deep blue-mix, smooth, R10/B

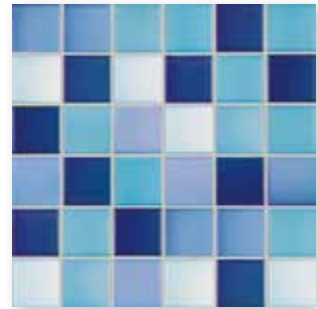

Mosaic sheet 30 x 30 cm, 12 x 12 in caribbean-blue-mix, smooth, R10/B



Mosaics glued thermoplastically on back of Agrob Buchtal can be used not only in dry zones but also without any problems in underwater areas (e.g. swimming pools/whirlpools) as well as in permanently wet areas (e.g. pool surrounds/showers).



Mosaic sheet 30 x 30 cm, 12 x 12 in denim blue-mix, smooth, R10/B,
Mosaic sheet 30 x 30 cm, 12 x 12 in denim blue-mix, smooth, R11/C



Mosaic sheet 30 x 30 cm, 12 x 12 in light blue-mix, smooth, R10/B,
Mosaic sheet 30 x 30 cm, 12 x 12 in light blue-mix, smooth, R11/C

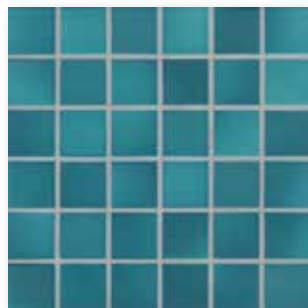

Mosaic sheet 30 x 30 cm, 12 x 12 in pacific blue-mix, smooth, R10/B,
Mosaic sheet 30 x 30 cm, 12 x 12 in pacific blue-mix, smooth, R11/C

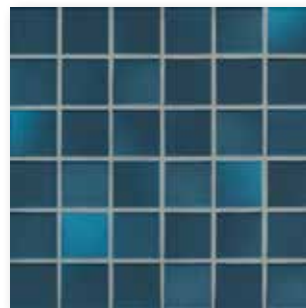

Mosaic sheet 30 x 30 cm, 12 x 12 in midnight blue-mix, smooth, R10/B,
Mosaic sheet 30 x 30 cm, 12 x 12 in midnight blue-mix, smooth, R11/C



Mosaic sheet 30 x 30 cm, 12 x 12 in vivid violet-mix, smooth, R10/B,
Mosaic sheet 30 x 30 cm, 12 x 12 in vivid violet-mix, smooth, R11/C

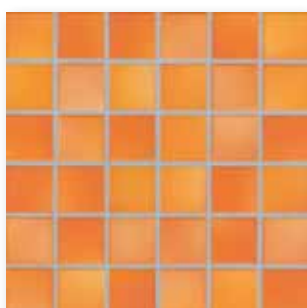

Mosaic sheet 30 x 30 cm, 12 x 12 in sunset orange-mix, smooth, R10/B,
Mosaic sheet 30 x 30 cm, 12 x 12 in sunset orange-mix, smooth, R11/C

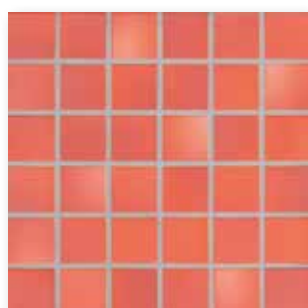

Mosaic sheet 30 x 30 cm coral red-mix, smooth, R10/B,
Mosaic sheet 30 x 30 cm, 12 x 12 in coral red-mix, smooth, R11/C

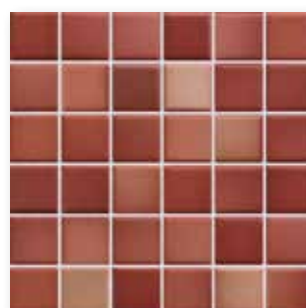

Mosaic sheet 30 x 30 cm, 12 x 12 in brick red-mix, smooth, R10/B

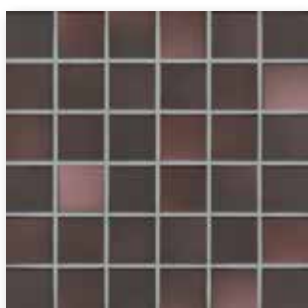

Mosaic sheet 30 x 30 cm, 12 x 12 in mystic red-mix, smooth, R10/B,
Mosaic sheet 30 x 30 cm, 12 x 12 in mystic red-mix, smooth, R11/C



Mosaic sheet 30 x 30 cm, 12 x 12 in forest green-mix, smooth, R10/B

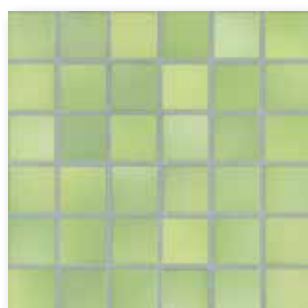

Mosaic sheet 30 x 30 cm, 12 x 12 in lime green-mix, smooth, R10/B,
Mosaic sheet 30 x 30 cm, 12 x 12 in lime green-mix, smooth, R11/C

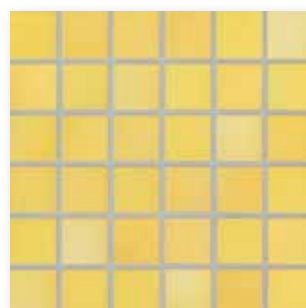

Mosaic sheet 30 x 30 cm, 12 x 12 in sunshine yellow-mix, smooth, R10/B,
Mosaic sheet 30 x 30 cm, 12 x 12 in sunshine yellow-mix, smooth, R11/C

Mosaic

Color Gradient ¹

2.5 x 2.5 cm



2.5 x 2.5 cm



Sheet: 297 x 297 mm

Sheet: 297 x 297 mm

Nom. dim. - cm/in	2.5 x 2.5 / 1 x 1	2.5 x 2.5 / 1 x 1				
Work size	23 x 23 x 6.5 mm	23 x 23 x 6.5 mm				
Surface	smooth, glossy	smooth, glossy				
m ² - pieces	11 sheets	11 sheets				
m ² - kg	12.100					
Bundle - pieces	11 sheets	8 sheets				
Bundle - m ²	1.000	0.800				
Bundle - kg	12.100	8.800				
Pallet - m ²	48.000					
Pallet - kg	580.800					
Product standard	Blb	Blb				
Slip resistance						
Stress group	1	1				
stress group	3					
snow white <input type="checkbox"/>	41200H Price gr. A229 (m ²)					
desert sand-mix <input type="checkbox"/>	3 41201H Price gr. A229 (m ²)					
taupe-mix <input type="checkbox"/>	3 41202H Price gr. A229 (m ²)					
light grey-mix <input type="checkbox"/>	3 41203H Price gr. A229 (m ²)					
medium grey-mix <input type="checkbox"/>	3 41204H Price gr. A229 (m ²)					
midnight black-mix <input type="checkbox"/>	2 41205H Price gr. A229 (m ²)					
denim blue-mix <input type="checkbox"/>	3 41206H Price gr. A250 (m ²)					
light blue-mix <input type="checkbox"/>	3 41207H Price gr. A250 (m ²)					
pacific blue-mix <input type="checkbox"/>	3 41208H Price gr. A250 (m ²)					
midnight blue-mix <input type="checkbox"/>	3 41209H Price gr. A250 (m ²)					
vivid violet-mix <input type="checkbox"/>	2 41210H Price gr. A250 (m ²)					
sunset orange-mix <input type="checkbox"/>	3 41211H Price gr. A250 (m ²)					
coral red-mix <input type="checkbox"/>	3 41212H Price gr. A250 (m ²)					
mystic red-mix <input type="checkbox"/>	2 41213H Price gr. A250 (m ²)					
lime green-mix <input type="checkbox"/>	3 41214H Price gr. A250 (m ²)					
sunshine <input type="checkbox"/>	3 41215H Price gr. A250 (m ²)					
yellow-mix <input type="checkbox"/>						
aqua <input type="checkbox"/>						
glossy <input type="checkbox"/>		41520H Price gr. A750 (pce.)				



¹ Work size without external joint: 297 x 2376 mm

The indicated price refers to the color gradient = 8 sheets

Color gradients can be designed individually. We would be delighted to examine the possibility of such customized production in individual cases.

Do you already know our Mosaic Designer at our website www.agrob-buchthal.com?

There, you will have the possibility of designing your individual color gradients, mosaic compositions and the laying of pictures.

Mosaic

2.5 x 2.5 cm

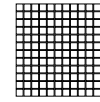

Sheet: 297 x 297 mm



						2.5 x 2.5 / 1 x 1		Nom. dim. - cm/in
						23 x 23 x 6.5 mm		Work size
						smooth, glossy		Surface
						11 sheets		m ² - pieces
						12.100		m ² - kg
						11 sheets		Bundle - pieces
						1.000		Bundle - m ²
						12.100		Bundle - kg
						48.000		Pallet - m ²
						580.800		Pallet - kg
						BIb		Product standard
								Slip resistance
						1		Stress group
						41216H	2	forest green mix <input type="checkbox"/> V2
						Price gr. A250 (m ²)		
						41217H	2	deep blue mix <input type="checkbox"/> V2
						Price gr. A250 (m ²)		
						41218H	2	brick red mix <input type="checkbox"/> V2
						Price gr. A250 (m ²)		
						41219H	3	silver grey mix <input type="checkbox"/> V2
						Price gr. A250 (m ²)		
						41220H	3	warm grey mix <input type="checkbox"/> V2
						Price gr. A250 (m ²)		
						41221H	2	white grey mix <input type="checkbox"/> V2
						Price gr. A250 (m ²)		
						41222H	2	caribbean-blue-mix <input type="checkbox"/> V2
						Price gr. A250 (m ²)		
						41223H	2	graphite black mix <input type="checkbox"/> V2
						Price gr. A250 (m ²)		
						41505 ³		midnight black-mix
						Price gr. A458 (pce.)		metallic glossy <input type="checkbox"/> V2
						41509 ³		midnight blue-mix
						Price gr. A458 (pce.)		metallic glossy <input type="checkbox"/> V2
						41510 ³		vivid violet-mix
						Price gr. A458 (pce.)		metallic glossy <input type="checkbox"/> V2
						41513 ^{1/3}	1	mystic red-mix
						Price gr. A458 (pce.)		metallic glossy <input type="checkbox"/> V2
						2452 ^{2/3}		gold
						Price gr. A394 (m ²)		silk-glossy <input type="checkbox"/> V1
						2455 ^{2/3}		platinum
						Price gr. A394 (m ²)		silk-glossy <input type="checkbox"/> V1

- ¹ Not or only to a limited extent resistant to acids and alkalis.
- ² To prevent the abrasion of the surface coating, laying on the floor or exposure to any comparable stress must be absolutely avoided.
- ³ without Hytect coating



Mosaic

2.5 x 2.5 cm



5 x 5 cm



5 x 5 cm



Sheet: 297 x 297 mm

Sheet: 297 x 297 mm

Sheet: 297 x 297 mm



Nom. dim. - cm/in	2.5 x 2.5 / 1 x 1	5 x 5 / 2 x 2	5 x 5 / 2 x 2			
Work size	23 x 23 x 6.5 mm	47 x 47 x 6.5 mm	47 x 47 x 6.5 mm			
Surface	smooth, matt	smooth, matt	smooth, matt			
m ² - pieces	11 sheets	11 sheets	11 sheets			
m ² - kg	12.100	12.331	12.331			
Bundle - pieces	11 sheets	11 sheets	11 sheets			
Bundle - m ²	1.000	1.000	1.000			
Bundle - kg	12.100	12.331	12.331			
Pallet - m ²	48.000	64.000	64.000			
Pallet - kg	580.800	789.184	789.184			
Product standard	Blb	Blb	Blb			
Slip resistance	R10/B	R10/B	R11/C			
Stress group	1	1	1			
	4					
snow white <input type="checkbox"/>	41300H Price gr. A238 (m ²)	41400H-73 Price gr. A196 (m ²)	41420H Price gr. A211 (m ²)			
desert sand-mix <input type="checkbox"/>	41301H Price gr. A238 (m ²)	41401H-73 Price gr. A196 (m ²)	41421H Price gr. A211 (m ²)			
taupe-mix <input type="checkbox"/>	3 41302H Price gr. A238 (m ²)	41402H-73 Price gr. A196 (m ²)	41422H Price gr. A211 (m ²)			
light grey-mix <input type="checkbox"/>	4 41303H Price gr. A238 (m ²)	41403H-73 Price gr. A196 (m ²)	41423H Price gr. A211 (m ²)			
medium grey-mix <input type="checkbox"/>	4 41304H Price gr. A238 (m ²)	41404H-73 Price gr. A196 (m ²)	41424H Price gr. A211 (m ²)			
midnight black-mix <input type="checkbox"/>	3 41305H Price gr. A238 (m ²)	41405H-73 Price gr. A196 (m ²)	41425H Price gr. A211 (m ²)			
denim blue-mix <input type="checkbox"/>	3 41306H Price gr. A259 (m ²)	41406H Price gr. A217 (m ²)	41426H Price gr. A229 (m ²)			
light blue-mix <input type="checkbox"/>	3 41307H Price gr. A259 (m ²)	41407H Price gr. A217 (m ²)	41427H Price gr. A229 (m ²)			
pacific blue-mix <input type="checkbox"/>	4 41308H Price gr. A259 (m ²)	41408H Price gr. A217 (m ²)	41428H Price gr. A229 (m ²)			
midnight blue-mix <input type="checkbox"/>	3 41309H Price gr. A259 (m ²)	41409H Price gr. A217 (m ²)	41429H Price gr. A229 (m ²)			
vivid violet-mix <input type="checkbox"/>	3 41310H Price gr. A259 (m ²)	41410H Price gr. A217 (m ²)	41430H Price gr. A229 (m ²)			
sunset orange-mix <input type="checkbox"/>	4 41311H Price gr. A259 (m ²)	41411H Price gr. A217 (m ²)	41431H Price gr. A229 (m ²)			
coral red-mix <input type="checkbox"/>	3 41312H Price gr. A259 (m ²)	41412H Price gr. A217 (m ²)	41432H Price gr. A229 (m ²)			
mystic red-mix <input type="checkbox"/>	3 41313H Price gr. A259 (m ²)	41413H Price gr. A217 (m ²)	41433H Price gr. A229 (m ²)			
lime green-mix <input type="checkbox"/>	3 41314H Price gr. A259 (m ²)	41414H Price gr. A217 (m ²)	41434H Price gr. A229 (m ²)			
sunshine yellow-mix <input type="checkbox"/>	4 41315H Price gr. A259 (m ²)	41415H Price gr. A217 (m ²)	41435H Price gr. A229 (m ²)			
forest green mix <input type="checkbox"/>	3 41316H Price gr. A259 (m ²)	41450H Price gr. A217 (m ²)				
deep blue mix <input type="checkbox"/>	2 41317H Price gr. A259 (m ²)	41451H Price gr. A217 (m ²)				
brick red mix <input type="checkbox"/>	3 41318H Price gr. A259 (m ²)	41452H Price gr. A217 (m ²)				
silver grey mix <input type="checkbox"/>	4 41319H Price gr. A259 (m ²)	41453H Price gr. A217 (m ²)				
warm grey mix <input type="checkbox"/>	4 41320H Price gr. A259 (m ²)	41454H Price gr. A217 (m ²)				
white grey mix <input type="checkbox"/>	3 41321H Price gr. A259 (m ²)	41455H Price gr. A217 (m ²)				
carribbean blue mix <input type="checkbox"/>	4 41322H Price gr. A259 (m ²)	41456H Price gr. A217 (m ²)				
graphite black mix <input type="checkbox"/>	3 41323H Price gr. A259 (m ²)	41457H Price gr. A217 (m ²)				

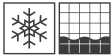







Homage to craftsmanship

The Karl collection interprets craftsmanship and original glazes in an exceptionally creative manner. Due to the type of glaze and the raw material recipe, different tile patterns are created each time during the firing process, which – laid as surface covering – radiate authentic and elementary appeal: symbolizing the simple life with the focus on the essential. The glazed variant is primarily recommended for wall design; the stone-matt version also for floors thanks to R10/B slip resistance. With the 2.5 x 2.5 cm variant, larger surfaces, columns or other structures can be designed particularly impressively. Like a tailor-made ceramic dress. The Stories series is recommended as suitable floor tile.

Studio photo / Architect: VSBL, Belgrade, Serbia / Photo: Jochen Stüber

Mosaic 2.5 x 2.5 cm, 1 x 1 in

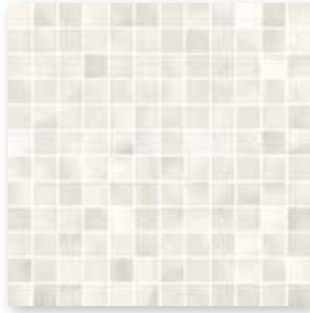

Mosaic sheet 30 x 30 cm, 12 x 12 in white structured,
Mosaic sheet 30 x 30 cm, 12 x 12 in white, structured, R10/B



Mosaic sheet 30 x 30 cm, 12 x 12 in nude, structured,
Mosaic sheet 30 x 30 cm, 12 x 12 in nude, structured, R10/B

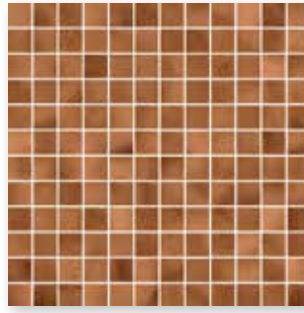

Mosaic sheet 30 x 30 cm, 12 x 12 in terra, structured,
Mosaic sheet 30 x 30 cm, 12 x 12 in terra, structured, R10/B



Mosaic sheet 30 x 30 cm, 12 x 12 in indigo, structured,
Mosaic sheet 30 x 30 cm, 12 x 12 in indigo, structured, R10/B

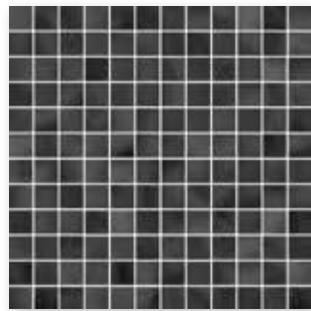

Mosaic sheet 30 x 30 cm, 12 x 12 in black, structured,
Mosaic sheet 30 x 30 cm, 12 x 12 in black, structured, R10/B



Mosaics glued thermoplastically on back of Agrob Buchtal can be used not only in dry zones but also without any problems in underwater areas (e.g. swimming pools/whirlpools) as well as in permanently wet areas.

Mosaic 10 x 10 cm, 4 x 4 in



Mosaic sheet 30 x 30 cm, 12 x 12 in
white, structured,
Mosaic sheet 30 x 30 cm, 12 x 12 in
white, structured, R10/B



Mosaic sheet 30 x 30 cm, 12 x 12 in
nude, structured,
Mosaic sheet 30 x 30 cm, 12 x 12 in
nude, structured, R10/B



Mosaic sheet 30 x 30 cm, 12 x 12 in
terra, structured,
Mosaic sheet 30 x 30 cm, 12 x 12 in
terra, structured, R10/B



Mosaic sheet 30 x 30 cm, 12 x 12 in
indigo, structured,
Mosaic sheet 30 x 30 cm, 12 x 12 in
indigo, structured, R10/B



Mosaic sheet 30 x 30 cm, 12 x 12 in
black, structured,
Mosaic sheet 30 x 30 cm, 12 x 12 in
black, structured, R10/B



Mosaic sheet 30 x 30 cm, 12 x 12 in
forest, structured,
Mosaic sheet 30 x 30 cm, 12 x 12 in
forest, structured, R10/B

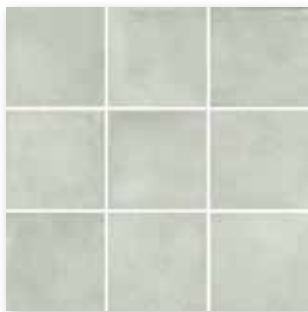

Mosaic sheet 30 x 30 cm, 12 x 12 in
grey green, structured,
Mosaic sheet 30 x 30 cm, 12 x 12 in
grey green, structured, R10/B

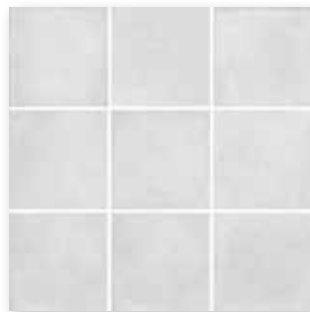

Mosaic sheet 30 x 30 cm, 12 x 12 in
grey, structured,
Mosaic sheet 30 x 30 cm, 12 x 12 in
grey, structured, R10/B

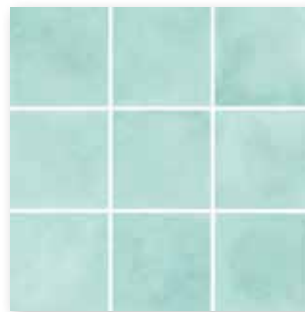

Mosaic sheet 30 x 30 cm, 12 x 12 in
aqua, structured,
Mosaic sheet 30 x 30 cm, 12 x 12 in
aqua, structured, R10/B

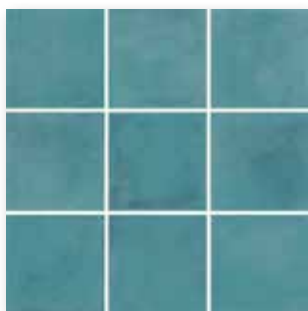

Mosaic sheet 30 x 30 cm, 12 x 12 in
ocean blue, structured,
Mosaic sheet 30 x 30 cm, 12 x 12 in
ocean blue, structured, R10/B



Wall tile 10 x 25 cm, 4 x 10 in white, structured



Wall tile 10 x 25 cm, 4 x 10 in nude, structured



Wall tile 10 x 25 cm, 4 x 10 in terra, structured



Wall tile 10 x 25 cm, 4 x 10 in indigo, structured

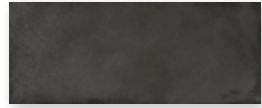

Wall tile 10 x 25 cm, 4 x 10 in black, structured

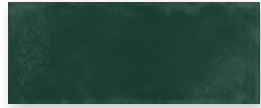

Wall tile 10 x 25 cm, 4 x 10 in forest, structured

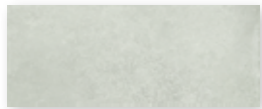

Wall tile 10 x 25 cm, 4 x 10 in grey green, structured



Wall tile 10 x 25 cm, 4 x 10 in grey, structured



Wall tile 10 x 25 cm, 4 x 10 in aqua, structured



Wall tile 10 x 25 cm, 4 x 10 in ocean blue, structured

Mosaic¹

Wall Tile

2.5 x 2.5 cm

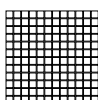

2.5 x 2.5 cm

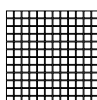

10 x 10 cm

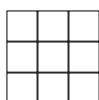

10 x 10 cm

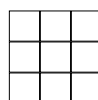

10 x 25 cm



Sheet: 297 x 297 mm

Sheet: 297 x 297 mm

Sheet: 297 x 297 mm

Sheet: 297 x 297 mm

	2.5 x 2.5 / 1 x 1	2.5 x 2.5 / 1 x 1	10 x 10 / 4 x 4	10 x 10 / 4 x 4	10 x 25 / 4 x 10	Nom. dim. - cm/in
	23 x 23 x 6.5 mm	23 x 23 x 6.5 mm	97 x 97 x 6.5 mm	97 x 97 x 6.5 mm	97 x 247 x 6.5 mm	Work size
	strukturiert, glossy	strukturiert, matt	strukturiert, glossy	strukturiert, matt	strukturiert, glossy	Surface
	11 sheets	11 sheets	11 sheets	11 sheets	40.000	m ² - pieces
	12.100	12.100	13.101	13.101	12.560	m ² - kg
	11 sheets	11 sheets	11 sheets	11 sheets	27	Bundle - pieces
	1.000	1.000	1.000	1.000	0.675	Bundle - m ²
	12.100	12.100	13.101	13.101	8.478	Bundle - kg
	48.000	48.000	64.000	64.000	86.400	Pallet - m ²
	580.800	580.800	838.464	838.464	1.058.184	Pallet - kg
	Bla (GL)	Bla (UGL)	Bla (GL)	Bla (UGL)	Bla (GL)	Product standard
		R10/B		R10/B		Slip resistance
	1	1	1	1	1	Stress group
	47050H	47075H	47250H	47275H	47650H	white <input type="checkbox"/> V3
	Price gr. A244 (m ²)	Price gr. A250 (m ²)	Price gr. A139 (m ²)	Price gr. A163 (m ²)	Price gr. A181 (m ²)	
	47051H	47076H	47251H	47276H	47651H	nude <input type="checkbox"/> V3
	Price gr. A244 (m ²)	Price gr. A250 (m ²)	Price gr. A139 (m ²)	Price gr. A163 (m ²)	Price gr. A181 (m ²)	
	47052H	47077H	47252H	47277H	47652H	terra <input type="checkbox"/> V3
	Price gr. A244 (m ²)	Price gr. A250 (m ²)	Price gr. A139 (m ²)	Price gr. A163 (m ²)	Price gr. A181 (m ²)	
	47053H	47078H	47253H	47278H	47653H	indigo <input type="checkbox"/> V3
	Price gr. A244 (m ²)	Price gr. A250 (m ²)	Price gr. A139 (m ²)	Price gr. A163 (m ²)	Price gr. A181 (m ²)	
	47054H	47079H	47254H	47279H	47654H	black <input type="checkbox"/> V3
	Price gr. A244 (m ²)	Price gr. A250 (m ²)	Price gr. A139 (m ²)	Price gr. A163 (m ²)	Price gr. A181 (m ²)	
			47255H	47280H	47655H	forest <input type="checkbox"/> V3
			Price gr. A139 (m ²)	Price gr. A163 (m ²)	Price gr. A181 (m ²)	
			47256H	47281H	47656H	grey green <input type="checkbox"/> V3
			Price gr. A139 (m ²)	Price gr. A163 (m ²)	Price gr. A181 (m ²)	
			47257H	47282H	47657H	grey <input type="checkbox"/> V3
			Price gr. A139 (m ²)	Price gr. A163 (m ²)	Price gr. A181 (m ²)	
			47258H	47283H	47658H	aqua <input type="checkbox"/> V3
			Price gr. A139 (m ²)	Price gr. A163 (m ²)	Price gr. A181 (m ²)	
			47259H	47284H	47659H	ocean blue <input type="checkbox"/> V3
			Price gr. A139 (m ²)	Price gr. A163 (m ²)	Price gr. A181 (m ²)	







KerAion Special glazes for operating theatres

Ideal for wall coverings in rooms where lasers are used such as e.g. operating theatres. These products perfectly meet the requirements with regard to diffusely reflecting surfaces: incident laser beams are "split up", thus preventing uncontrolled reflection. This is confirmed by the expert opinion of the Laser Medical Centre Berlin and applies to the following types of lasers normally used in medical applications:

- Argon – a typical visible laser
- Nd:YAG – a typical laser in the close-infrared range
- Excimer – a typical UV-laser
- CO₂ – a typical laser in the mid-infrared range

Special advantage of the large model size of 60 x 60 cm: reduced number of joints, therefore easy to clean and hygienic. Perfect complement for the floor: the static electricity conducting panel ELA 10.6 (see page 189), also in model size 60 x 60 cm.



blue



green



grey



light grey



beige

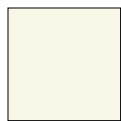

white

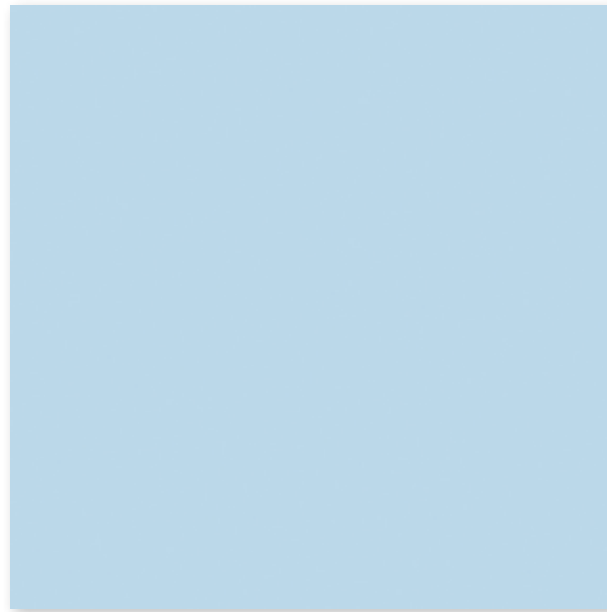

Floor/Wall panels 60 x 60 cm, 24 x 24 in, smooth

The following series is also suitable:

- matt glazes of the series Plural (see page 338 and the following)

In the chapter Technical Information you find the following additional information about this mono-colored series:

- NCS Natural Color System
- RAL-Color Chart
- Lightness Values

Floor/Wall Tiles

60 x 60 cm¹

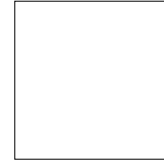

						B600HK		Model number
						60 x 60 / 24 x 24		Nom. dim. - cm/in
						597 x 597 x 8 mm		Work size
						smooth, silky-matt		Surface
						2.780		m ² - pieces
						18.014		m ² - kg
						4		Bundle - pieces
						1.439		Bundle - m ²
						25.920		Bundle - kg
						43.165		Pallet - m ²
						777.600		Pallet - kg
						Alb		Product standard
						2203-B600HK	4	
						Price gr. A256 (m ²)		white <input type="checkbox"/> VO
						2204-B600HK	4	
						Price gr. A256 (m ²)		beige <input type="checkbox"/> VO
						2205-B600HK	4	
						Price gr. A256 (m ²)		light-grey <input type="checkbox"/> VO
						2206-B600HK	3	
						Price gr. A256 (m ²)		grey <input type="checkbox"/> VO
						2207-B600HK	3	
						Price gr. A256 (m ²)		green <input type="checkbox"/> VO
						2208-B600HK	4	
						Price gr. A256 (m ²)		blue <input type="checkbox"/> VO

The panels of the series KerAion OP Special Glazes are also available in other sizes (up to the maximum edge length of 120 cm) and glazes. When required, please contact your advisor to customers.

The narrow joints, the large size and the Hytect coating effectively support easy cleaning and a high standard of hygiene.







Tiles for living spaces

Tiles for living spaces – private living, gastronomy & hotels or public buildings in which the focus is on well-being. Rooms in which one likes to spend time. LIKE is a tile collection that is made to create a perfect whole in combination with other materials. The look is discreetly lively – fine irregularities give the tiles their unmistakable character and bring out each of the 5 colors perfectly. Whether mosaic or large format, the LIKE series always unfolds its full charm – both in the room and on the terrace.

Rendering



R10/A+B



graphite



ash grey



cement



warm grey



off white



Floor tile 30 x 60 cm, 12 x 24 in, structured, R10/A+B



Floor tile 60 x 60 cm, 24 x 24 in, structured, R10/A+B



Floor tile 80 x 80 cm, 32 x 32 in, structured, R10/A+B



Floor tile 120 x 120 cm, 48 x 48 in, structured, R10/A+B



Stair tile 30 x 60 cm, 12 x 24 in, 12 x 24 in (with grooves), structured, R10/A+B



Skirting, rounded 7 x 60 cm, 2 13/16 x 24 in, structured



R10/A+B



Mosaic 5 x 5 cm, 2 x 2 in

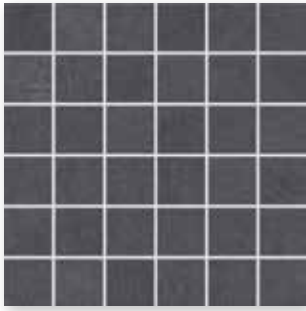

Mosaic sheet 30 x 30 cm, 12 x 12 in graphite, structured, R10/A+B

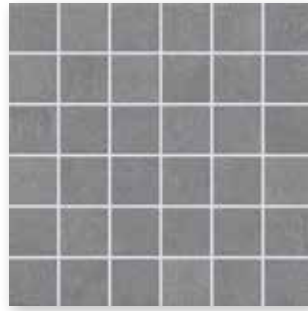

Mosaic sheet 30 x 30 cm, 12 x 12 in ash grey, structured, R10/A+B



Mosaic sheet 30 x 30 cm, 12 x 12 in cement, structured, R10/A+B



Mosaic sheet 30 x 30 cm, 12 x 12 in warm grey, structured, R10/A+B



Mosaic sheet 30 x 30 cm, 12 x 12 in off white, structured, R10/A+B

Mosaic: Glass fibre net on reverse side, Sheet: 297 x 297 mm.

Decoration elements



Border Tweed 30 x 44.5 cm, 12 x 18 in graphite, structured, R10/A+B

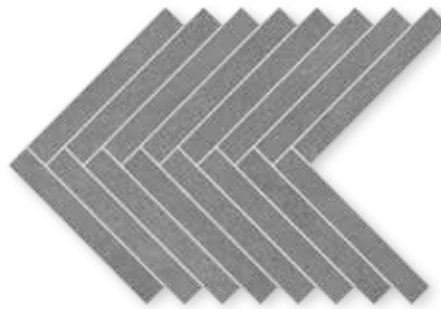

Border Tweed 30 x 44.5 cm, 12 x 18 in ash grey, structured, R10/A+B



Border Tweed 30 x 44.5 cm, 12 x 18 in cement, structured, R10/A+B



Border Tweed 30 x 44.5 cm, 12 x 18 in warm grey, structured, R10/A+B



Border Tweed 30 x 44.5 cm, 12 x 18 in off white, structured, R10/A+B

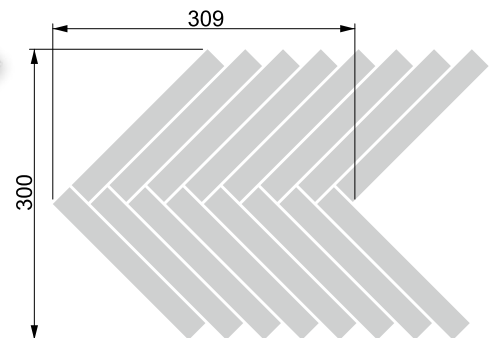

Border: Glass fibre net on reverse side, Sheet: 297 x 442 mm.



graphite



ash grey



cement



warm grey



off white

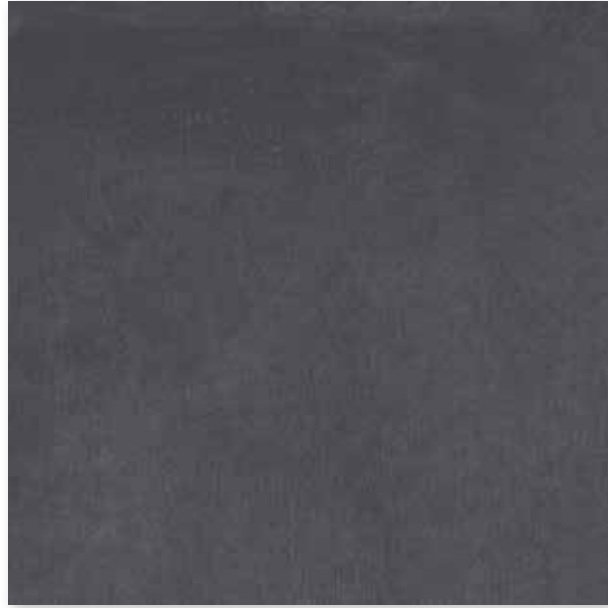

Patio tile 60 x 60 cm, 24 x 24 in, structured, R11/B



graphite



cement



Patio Tile 120 x 120 cm, 48 x 48 in, structured, R11/B

Mosaic^{1/3}

5 x 5 cm



Sheet: 297 x 297 mm

Decoration Elements^{2/3}

30 x 44,5 cm

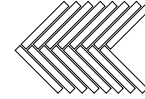

Border
Sheet: 297 x 442 mm



					5 x 5 / 2 x 2	30 x 44.5 / 12 x 18			Nom. dim. - cm/in
					47 x 47 x 9 mm	297 x 442 x 9 mm			Work size
					structured, matt	structured, matt			Surface
					11.111/m ²	3.236/m			m²/m - pieces
					19.833/m ²	5.191/m			m²/m - kg
					12	2			Bundle - pieces
					1.080 m ²	0.618 m			Bundle - m ² /m
					21.420	3.208			Bundle - kg
					32.400				Pallet - m ²
					642.600				Pallet - kg
					Bla	Bla			Product standard
					R10/A+B	R10/A+B			Slip resistance
					2	2			Stress group
					430640	430635			graphite <input type="checkbox"/> V2
					Price gr. W303 (m ²)	Price gr. W515 (pce.)			
					430641	430636			ash grey <input type="checkbox"/> V2
					Price gr. W303 (m ²)	Price gr. W515 (pce.)			
					430642	430637			cement <input type="checkbox"/> V2
					Price gr. W303 (m ²)	Price gr. W515 (pce.)			
					430643	430638			warm grey <input type="checkbox"/> V2
					Price gr. W303 (m ²)	Price gr. W515 (pce.)			
					430644	430639			off white <input type="checkbox"/> V2
					Price gr. W303 (m ²)	Price gr. W515 (pce.)			



1



² Decoration elements only available in full boxes.

³ Glass fibre net on reverse side

Floor Tiles¹

30 x 60 cm



60 x 60 cm

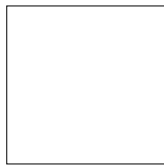



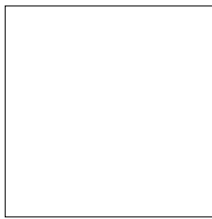

80 x 80 cm²

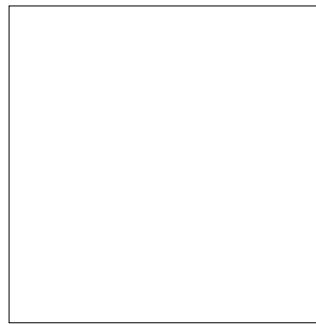

120 x 120 cm^{2/3}



protected

Nom. dim. - cm/in	30 x 60 / 12 x 24	60 x 60 / 24 x 24	80 x 80 / 32 x 32		120 x 120 / 48 x 48		
Work size	297 x 596 x 9 mm	596 x 596 x 9 mm	795 x 795 x 9 mm		1194 x 1194 x 9 mm		
Surface	structured, matt	structured, matt	structured, matt		structured, matt		
m ² - pieces	5.556	2.778	1.563		0.694		
m ² - kg	19.841	19.288	21.381		21.098		
Bundle - pieces	7	3	2		2		
Bundle - m ²	1.260	1.080	1.280		2.882		
Bundle - kg	24.997	20.829	27.360		60.800		
Pallet - m ²	50.396	43.197	61.420		57.637		
Pallet - kg	999.880	833.160	1,313.280		1,216.000		
Product standard	Bla	Bla	Bla		Bla		
Slip resistance	R10/A+B	R10/A+B	R10/A+B		R10/A+B		
Stress group	2	2	2		2		
graphite 	430645 Price gr. W102 (m ²)	430650 Price gr. W117 (m ²)	430655 Price gr. W138 (m ²)		430660 Price gr. W177 (m ²)		
ash grey 	430646 Price gr. W102 (m ²)	430651 Price gr. W117 (m ²)	430656 Price gr. W138 (m ²)		430661 Price gr. W177 (m ²)		
cement 	430647 Price gr. W102 (m ²)	430652 Price gr. W117 (m ²)	430657 Price gr. W138 (m ²)		430662 Price gr. W177 (m ²)		
warm grey 	430648 Price gr. W102 (m ²)	430653 Price gr. W117 (m ²)	430658 Price gr. W138 (m ²)		430663 Price gr. W177 (m ²)		
off white 	430649 Price gr. W102 (m ²)	430654 Price gr. W117 (m ²)	430659 Price gr. W138 (m ²)		430664 Price gr. W177 (m ²)		



² Please note: special pallet. No return, no exchange.

³ High weight only to carry with two persons.

Stair Tile¹

30 x 60 cm²

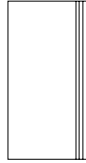

Skirting, rounded¹

7 x 60 cm



Patio Tiles¹

60 x 60 cm³



120 x 120 cm^{3/4}

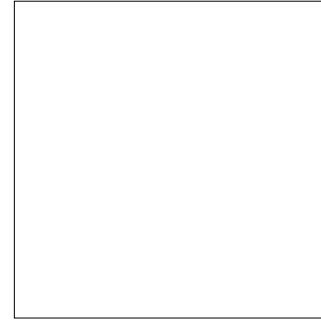

protected

	30 x 60 / 12 x 24	7 x 60 / 2 13/16 x 24	60 x 60 / 24 x 24	120 x 120 / 48 x 48		Nom. dim. - cm/in
	297 x 596 x 9 mm	70 x 596 x 9 mm	596 x 596 x 20 mm	1198 x 1198 x 20 mm		Work size
	structured, matt	structured, matt	structured, matt	structured, matt		Surface
	1.667/m	1.667/m	2.778/m ²	0.700/m ²		m ² /m - pieces
	5.972/m	1.357/m	47.226/m ²	46.567/m ²		m ² /m - kg
	7	22	2	1		Bundle - pieces
	4.199 m	13.197 m	0.720 m ²	1.440 m ²		Bundle - m ² /m
	25.081	17.908	34.000	67.100		Bundle - kg
			21.598	28.563		Pallet - m ²
			1,020.000	1,342.000		Pallet - kg
	Bla	Bla	Bla	Bla		Product standard
	R10/A+B		R11/B	R11/B		Slip resistance
	2		4	4		Stress group
	430672	430677	430665	430670		graphite <input type="checkbox"/> V2
	Price gr. W473 (pce.)	Price gr. W439 (pce.)	Price gr. W177 (m ²)	Price gr. W261 (m ²)		ash grey <input type="checkbox"/> V2
	430673	430678	430666			cement <input type="checkbox"/> V2
	Price gr. W473 (pce.)	Price gr. W439 (pce.)	Price gr. W177 (m ²)			warm grey <input type="checkbox"/> V2
	430674	430679	430667	430671		off white <input type="checkbox"/> V2
	Price gr. W473 (pce.)	Price gr. W439 (pce.)	Price gr. W177 (m ²)	Price gr. W261 (m ²)		
	430675	430680	430668			
	Price gr. W473 (pce.)	Price gr. W439 (pce.)	Price gr. W177 (m ²)			
	430676	430681	430669			
	Price gr. W473 (pce.)	Price gr. W439 (pce.)	Price gr. W177 (m ²)			



³ High weight only to carry with two persons.

⁴ Please note: special pallet. No return, no exchange.



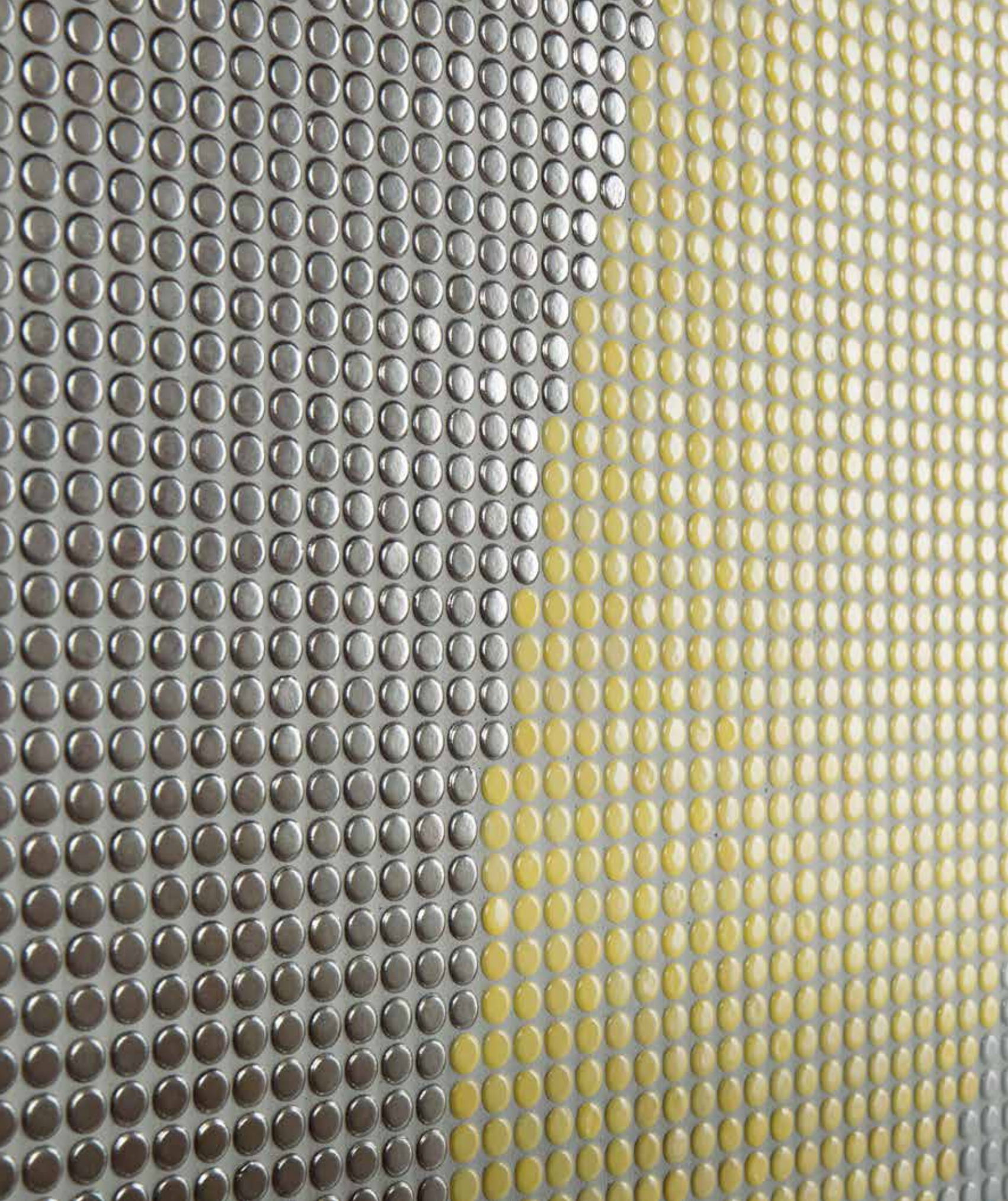



Fine and round

The perfect answer to the trend towards soft, rounded designs is the mosaic Loop. It is available in 15 finely nuanced, high-gloss colors, six of which are also available in a matt, slip-resistant version. This extends the range of applications to showers and other wet areas. In addition x+to the mosaic with a 2 cm diameter, a 1 cm variant is also available, which conveys a particularly filigree and elegant impression. In contrasting colors, it is also suitable for pictograms, letters, arrows and QR codes.

Studio photo

Mosaic Ø 1 cm, Ø 3/8 in

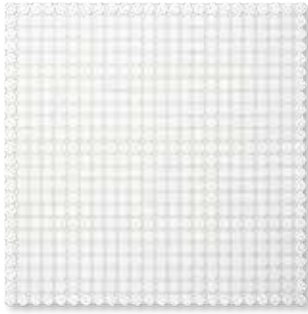

Mosaic sheet 32 x 32 cm, 13 x 13 in arctic white glossy, smooth

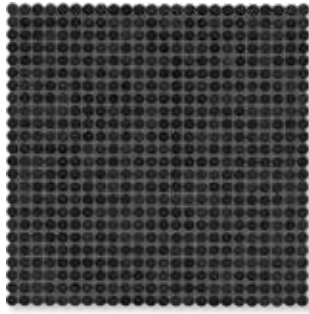

Mosaic sheet 32 x 32 cm, 13 x 13 in night black glossy, smooth



Mosaic sheet 32 x 32 cm, 13 x 13 in light ivory glossy, smooth



Mosaic sheet 32 x 32 cm, 13 x 13 in ivory glossy, smooth



Mosaic sheet 32 x 32 cm, 13 x 13 in light diamond grey glossy, smooth



Mosaic sheet 32 x 32 cm, 13 x 13 in diamond grey glossy, smooth

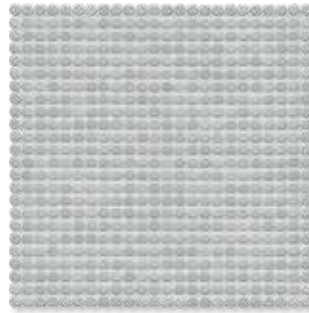

Mosaic sheet 32 x 32 cm, 13 x 13 in denim glossy, smooth



Mosaic sheet 32 x 32 cm, 13 x 13 in light aqua blue glossy, smooth



Mosaic sheet 32 x 32 cm, 13 x 13 in aqua blue glossy, smooth

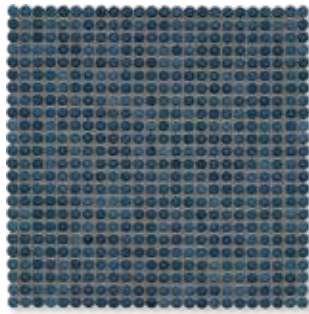

Mosaic sheet 32 x 32 cm, 13 x 13 in steel blue glossy, smooth

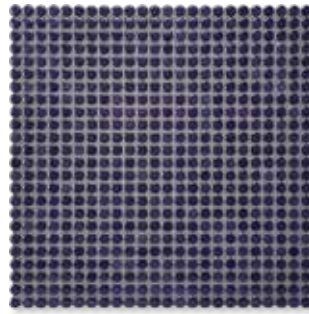

Mosaic sheet 32 x 32 cm, 13 x 13 in dark violet glossy, smooth

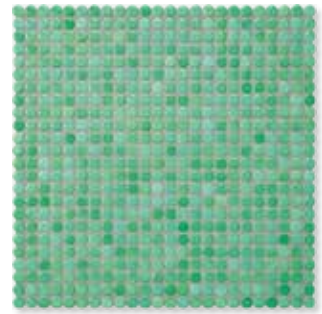

Mosaic sheet 32 x 32 cm, 13 x 13 in sea green glossy, smooth



Mosaic sheet 32 x 32 cm, 13 x 13 in coral-red glossy, smooth

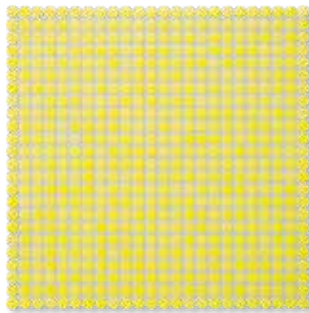

Mosaic sheet 32 x 32 cm, 13 x 13 in lemon-yellow glossy, smooth

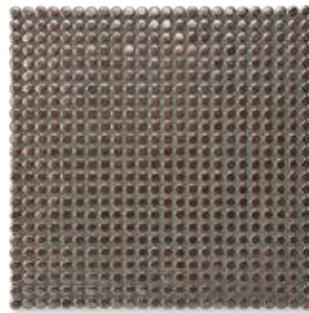

Mosaic sheet 32 x 32 cm, 13 x 13 in bronze-metallic glossy, smooth

The products depicted can also be manufactured in other colors. We would be delighted to examine the possibility of such customized production in individual cases.



Mosaics glued thermoplastically on back of Agrob Buchtal can be used not only in dry zones but also without any problems in underwater areas (e.g. swimming pools/whirlpools) as well as in permanently wet areas.

Color gradient
Ø 1 cm, Ø 3/8 in

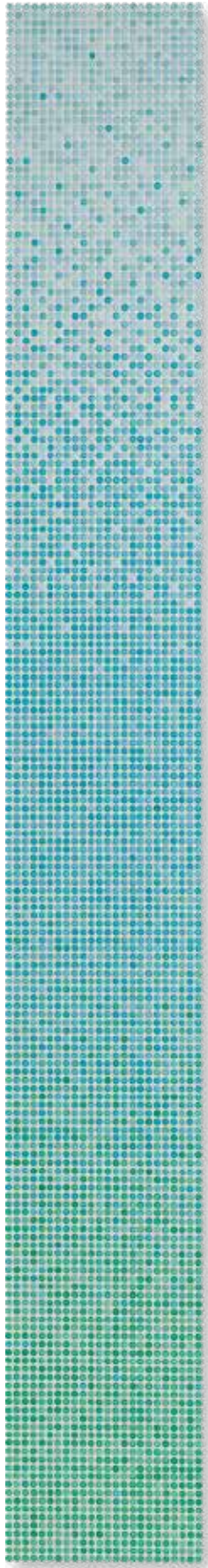

ocean glossy

Color gradient
Ø 2 cm, Ø 6/8 in



ocean glossy

More examples

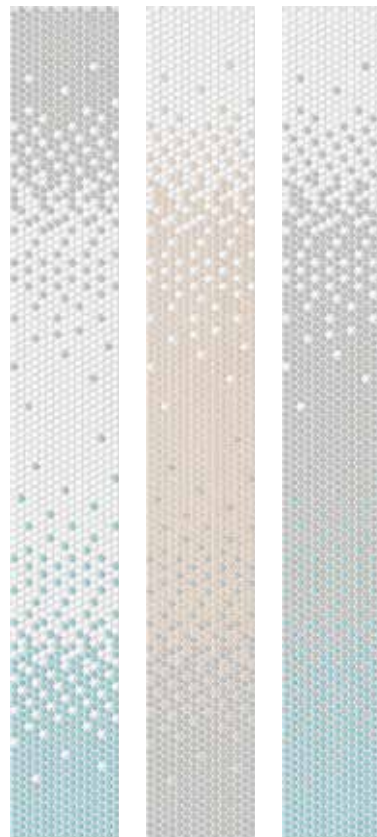
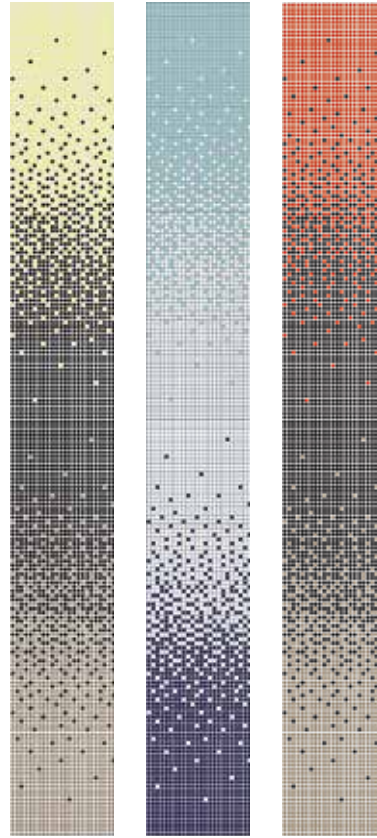

production size without external joint
314 x 2,528 x 6.5 mm

The colors of Loop can be randomly replaced in the standard color gradient without extra charge. We will be pleased to check an individual design of color gradients with regard to dimensions and color combinations as customized production.

Do you already know our Mosaic Designer at our website www.agrob-buchtal.com? There, you will have the possibility of designing your individual color gradients, mosaic compositions and the laying of pictures.

Mosaic Ø 2 cm, Ø 6/8 in



Mosaic sheet 32 x 32 cm, 13 x 13 in arctic white glossy, smooth, Mosaic sheet 32 x 32 cm, 13 x 13 in arctic white, smooth, R10/B



Mosaic sheet 32 x 32 cm, 13 x 13 in night black glossy, smooth, Mosaic sheet 32 x 32 cm, 13 x 13 in night black, smooth, R10/B



Mosaic sheet 32 x 32 cm, 13 x 13 in light ivory glossy, smooth, Mosaic sheet 32 x 32 cm, 13 x 13 in light ivory, smooth, R10/B



Mosaic sheet 32 x 32 cm, 13 x 13 in ivory glossy, smooth

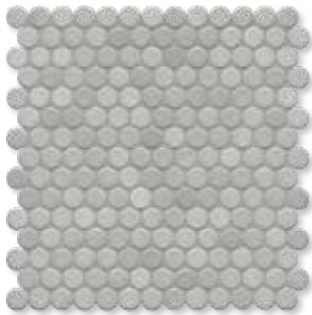

Mosaic sheet 32 x 32 cm, 13 x 13 in light diamond grey glossy, smooth, Mosaic sheet 32 x 32 cm, 13 x 13 in light diamond grey, smooth, R10/B



Mosaic sheet 32 x 32 cm, 13 x 13 in diamond grey glossy, smooth



Mosaic sheet 32 x 32 cm, 13 x 13 in denim glossy, smooth



Mosaic sheet 32 x 32 cm, 13 x 13 in light aqua blue glossy, smooth, Mosaic sheet 32 x 32 cm, 13 x 13 in light aqua blue, smooth, R10/B



Mosaic sheet 32 x 32 cm, 13 x 13 in aqua blue glossy, smooth, Mosaic sheet 32 x 32 cm, 13 x 13 in aqua blue, smooth, R10/B

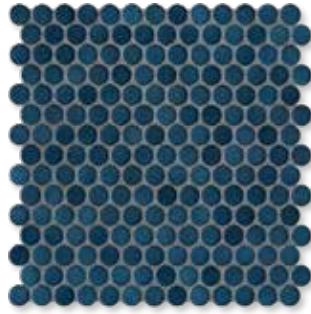

Mosaic sheet 32 x 32 cm, 13 x 13 in steel blue glossy, smooth



Mosaic sheet 32 x 32 cm, 13 x 13 in dark violet glossy, smooth

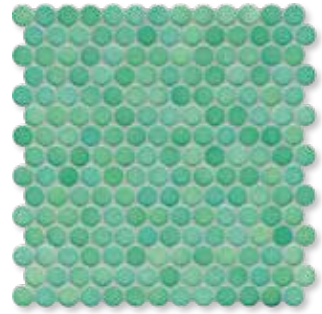

Mosaic sheet 32 x 32 cm, 13 x 13 in sea green glossy, smooth, Mosaic sheet 32 x 32 cm, 13 x 13 in sea green, smooth, R10/B

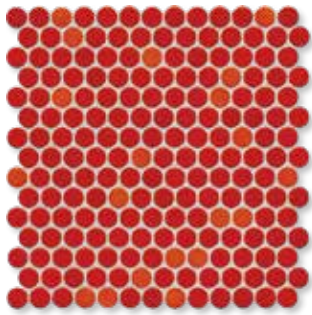

Mosaic sheet 32 x 32 cm, 13 x 13 in coral-red glossy, smooth

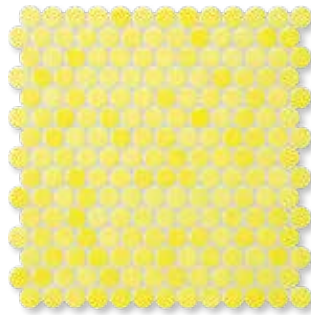

Mosaic sheet 32 x 32 cm, 13 x 13 in lemon-yellow glossy, smooth



Mosaic sheet 32 x 32 cm, 13 x 13 in bronze-metallic glossy, smooth



Mosaics glued thermoplastically on back of Agrob Buchtal can be used not only in dry zones but also without any problems in underwater areas (e.g. swimming pools/whirlpools) as well as in permanently wet areas.

Mosaic

Color Gradient

Ø 1 cm

Ø 2 cm

Ø 1 cm^{1/3}

Ø 2 cm^{2/3}

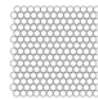
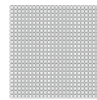

		Sheet: 316 x 316 mm	Sheet: 326 x 316 mm	Sheet: 316 x 316 mm	Sheet: 326 x 316 mm	
		Ø 1 / 3/8	Ø 2 / 6/8	Ø 1 / Ø 3/8	Ø 2 / 6/8	Nom. dim. - cm/in
		Ø 12 x 6.5 mm	Ø 22.3 x 6.5 mm	Ø 12 x 6.5 mm	Ø 22.3 x 6.5 mm	Work size
		smooth, glossy	smooth, glossy	smooth, glossy	smooth, glossy	Surface
		10 sheets	10 sheets			m ² - pieces
		9.720	11.600			m ² - kg
		10 sheets	10 sheets	8 sheets	8 sheets	Bundle - pieces
		1.000	1.000	0.800	0.800	Bundle - m ²
		9.720	11.600	7.776	8.872	Bundle - kg
		24.000	48.000			Pallet - m ²
		233.280	556.800			Pallet - kg
		Bib	Bib	Bib	Bib	Product standard
		40000H	40020H			3 arctic white
		Price gr. A382 (m ²)	Price gr. A304 (m ²)			glossy <input type="checkbox"/> V2
		40001H	40021H			2 night black
		Price gr. A382 (m ²)	Price gr. A304 (m ²)			glossy <input type="checkbox"/> V2
		40002H	40022H			3 light ivory
		Price gr. A382 (m ²)	Price gr. A304 (m ²)			glossy <input type="checkbox"/> V2
		40003H	40023H			3 ivory
		Price gr. A382 (m ²)	Price gr. A304 (m ²)			glossy <input type="checkbox"/> V2
		40004H	40024H			3 light diamond grey
		Price gr. A382 (m ²)	Price gr. A304 (m ²)			glossy <input type="checkbox"/> V2
		40005H	40025H			2 diamond grey
		Price gr. A382 (m ²)	Price gr. A304 (m ²)			glossy <input type="checkbox"/> V2
		40006H	40026H			3 denim
		Price gr. A382 (m ²)	Price gr. A304 (m ²)			glossy <input type="checkbox"/> V2
		40007H	40027H			3 light aqua blue
		Price gr. A382 (m ²)	Price gr. A304 (m ²)			glossy <input type="checkbox"/> V2
		40008H	40028H			2 aqua blue
		Price gr. A382 (m ²)	Price gr. A304 (m ²)			glossy <input type="checkbox"/> V2
		40009H	40029H			2 steel blue
		Price gr. A382 (m ²)	Price gr. A304 (m ²)			glossy <input type="checkbox"/> V2
		40010H	40030H			2 dark violet
		Price gr. A382 (m ²)	Price gr. A304 (m ²)			glossy <input type="checkbox"/> V2
		40011H	40031H			3 sea green
		Price gr. A382 (m ²)	Price gr. A304 (m ²)			glossy <input type="checkbox"/> V2
		40012H	40032H			2 coral-red
		Price gr. A382 (m ²)	Price gr. A304 (m ²)			glossy <input type="checkbox"/> V2
		40013H	40033H			3 lemon-yellow
		Price gr. A382 (m ²)	Price gr. A304 (m ²)			glossy <input type="checkbox"/> V2
		40014^{4/5}	40034^{4/5}			1 bronze-metallic <input type="checkbox"/> V2
		Price gr. A385 (m ²)	Price gr. A346 (m ²)			
				40056H	40057H	2 ocean
				Price gr. A791 (pce.)	Price gr. A750 (pce.)	glossy <input type="checkbox"/> V2

¹ Work size without external joint: 316 x 2528 x 6.5 mm

² Work size without external joint: 326 x 2528 x 6.5 mm

³ The indicated price refers to the color gradient = 8 sheets

⁴ Not or only to a limited extent resistant to acids and alkalis.

⁵ without Hytect



Color gradients can be designed individually. We would be delighted to examine the possibility of such customized production in individual cases.

Do you already know our Mosaic Designer at our website www.agrob-buchtal.com?

There, you will have the possibility of designing your individual color gradients, mosaic compositions and the laying of pictures.

Mosaic

Ø 2 cm



Sheet: 326 x 316 mm

Nom. dim. - cm/in	Ø 2 / 6/8						
Work size	Ø 22.3 x 6.5 mm						
Surface	smooth, matt						
m ² - pieces	10 sheets						
m ² - kg	11.600						
Bundle - pieces	10 sheets						
Bundle - m ²	1.000						
Bundle - kg	11.600						
Pallet - m ²	48.000						
Pallet - kg	556.800						
Product standard	BIb						
Slip resistance	R10/B						
	4 40040H						
arctic white <input type="checkbox"/>	Price gr. A313 (m ²)						
	2 40041H						
night black <input type="checkbox"/>	Price gr. A313 (m ²)						
	4 40042H						
light ivory <input type="checkbox"/>	Price gr. A313 (m ²)						
	4 40044H						
light diamond grey <input type="checkbox"/>	Price gr. A313 (m ²)						
	4 40047H						
aqua blue light <input type="checkbox"/>	Price gr. A313 (m ²)						
	3 40048H						
aqua blue <input type="checkbox"/>	Price gr. A313 (m ²)						
	3 40071H						
sea green <input type="checkbox"/>	Price gr. A313 (m ²)						

The products depicted can also be manufactured in other colors.
We would be delighted to examine the possibility of such customized production in individual cases.



Lintharena, Näfels, Switzerland / Architect: K & L Architekten AG, St. Gallen, Switzerland
Series: Loop, special composition / Photo: Kim Britt Photography







Natural design scope

Unique in its ceramic composition and with color nuances between anthracite and white, the series Lounge looks fantastic in any room. The Stone decor with its discreet marble and stone look is the highlight of every room design – on large or small surfaces. The colorful Garden decoration whisks us away to the exotic gardens of this world. All tiles are Hytect-coated and thus easy to clean.

Rendering

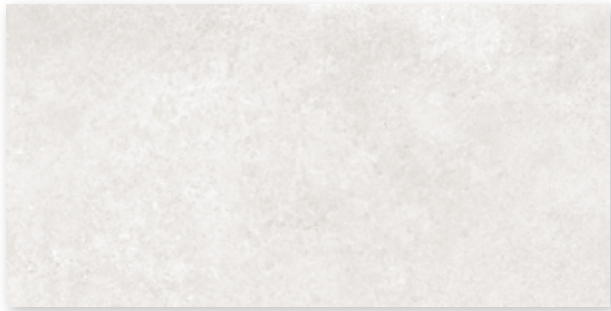

Wall tile 30 x 60 cm, 12 x 24 in, light taupe, structured



Wall tile 30 x 60 cm, 12 x 24 in, grey white, structured



Wall tile 30 x 90 cm, 12 x 36 in, light taupe, structured

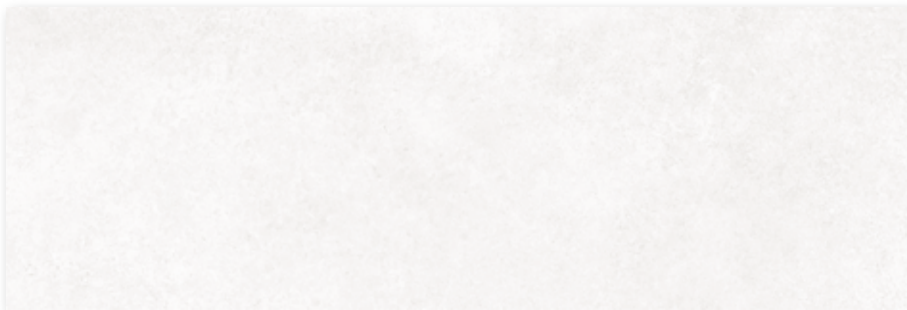

Wall tile 30 x 90 cm, 12 x 36 in, grey white, structured

Decoration elements



Decorative tile Garden 30 x 60 cm, 12 x 24 in, green mix, structured



Decorative tile Stone 30 x 90 cm, 12 x 36 in, grey mix, structured

The decoration you have chosen is a high-quality product made of glazed earthenware. The decoration consists of different individual pictures. The connections of the individual pictures are deliberately designed freely and thus do not connect in the continuous laying. The composition of the motifs in the box may vary due to production reasons.

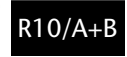

dark taupe

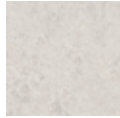

light sand



warm grey



dark anthracite



Floor tile 30 x 60 cm, 12 x 24 in, structured, R10/A+B



Floor tile 60 x 60 cm, 24 x 24 in, structured, R10/A+B



Floor tile 60 x 120 cm, 24 x 48 in, structured, R10/A+B



Floor tile 120 x 120 cm, 48 x 48 in, structured, R10/A+B



Skirting, rounded 7 x 60 cm, 2 13/16 x 24 in, structured

Mosaic 5 x 5 cm, 2 x 2 in



Mosaic sheet 30 x 30 cm, 12 x 12 in dark taupe, structured, R10/A+B



Mosaic sheet 30 x 30 cm, 12 x 12 in light sand, structured, R10/A+B

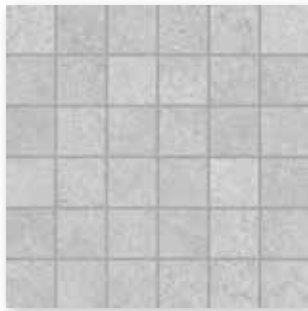

Mosaic sheet 30 x 30 cm, 12 x 12 in warm grey, structured, R10/A+B

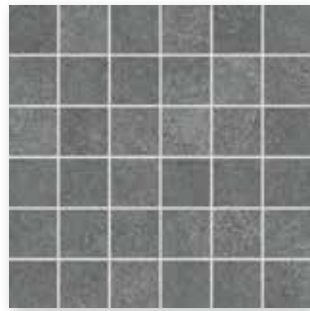

Mosaic sheet 30 x 30 cm, 12 x 12 in dark anthracite, structured, R10/A+B

Mosaic: Glass fibre net on reverse side,
Sheet: 297 x 297 mm.

Wall Tiles

Decoration Elements²

30 x 60 cm

30 x 90 cm¹

30 x 60 cm

30 x 90 cm¹

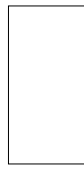

		<i>Decorative tile Garden</i>		<i>Decorative tile Stone</i>		
		30 x 60 / 12 x 24	30 x 90 / 12 x 36	30 x 60 / 12 x 24	30 x 90 / 6 x 36	Nom. dim. - cm/in
		297 x 597 x 6 mm	297 x 897 x 6 mm	297 x 597 x 6 mm	297 x 897 x 6 mm	Work size
		structured, silky-matt	structured, silky-matt	structured, stone-matt	structured, stone-matt	Surface
		5.556	3.704	5.556	3.704	m ² - pieces
		10.279	10.400	10.279	10.400	m ² - kg
		13	8	13	8	Bundle - pieces
		2.340	2.160	2.340	2.160	Bundle - m ²
		24.050	22.464	24.050	22.464	Bundle - kg
		112.311	51.836	112.311	51.836	Pallet - m ²
		1,154.400	539.136	1,154.400	539.136	Pallet - kg
		BIII	BIII	BIII	BIII	Product standard
		203392H	323395H			light taupe <input type="checkbox"/> V2
		Price gr. C77 (m ²)	Price gr. C143 (m ²)			grey white <input type="checkbox"/> V2
		203393H	323396H			green mix <input type="checkbox"/> V4
		Price gr. C77 (m ²)	Price gr. C143 (m ²)	203394H		grey mix <input type="checkbox"/> V4
				Price gr. C89 (m ²)		
					323397H	
					Price gr. C149 (m ²)	



² Decoration elements only available in full boxes.

Mosaic^{1/5}

Floor Tiles¹

Skirting, cut¹

5 x 5 cm



30 x 60 cm

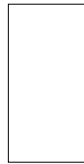

60 x 60 cm



60 x 120 cm^{3/4}

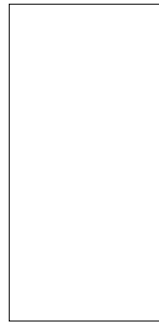



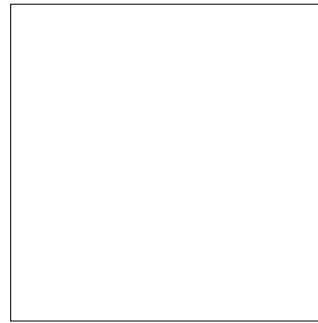

120 x 120 cm^{2/3/4}



7 x 60 cm



Sheet: 297 x 297 mm

Nom. dim. - cm/in	5 x 5 / 2 x 2	30 x 60 / 12 x 24	60 x 60 / 24 x 24	60 x 120 / 24 x 48	120 x 120 / 48 x 48	7 x 60 / 2 13/16 x 24
Work size	47 x 47 x 6 mm	297 x 597 x 6 mm	597 x 597 x 6 mm	597 x 1197 x 6 mm	1198 x 1198 x 6 mm	70 x 597 x 6 mm
Surface	structured, matt	structured, matt	structured, matt	structured, matt	structured, matt	structured, matt
m ² /m - pieces	11.111/m ²	5.556/m ²	2.778/m ²	1.388/m ²	0.694/m ²	1.667/m
m ² /m - kg	11.488/m ²	13.273/m ²	13.581/m ²	14.088/m ²	14.100/m ²	0.938/m
Bundle - pieces	11 sheets	10	5	3	2	38
Bundle - m ² /m	0.990 m ²	1.800 m ²	1.800 m ²	2.161 m ²	2.882 m ²	22.795 m
Bundle - kg	11.374	23.890	24.445	30.450	40.600	21.394
Pallet - m ²	35.640	71.994	64.795	75.648	69.124	
Pallet - kg	409.464	955.600	880.020	1,065.750	974.400	
Product standard	Bla	Bla	Bla	Bla	Bla	Bla
Slip resistance	R10/A+B	R10/A+B	R10/A+B	R10/A+B	R10/A+B	
Stress group	1	1	1	1	1	1
dark taupe 	431328H Price gr. C308 (m ²)	431332H Price gr. C98 (m ²)	431336H Price gr. C107 (m ²)	431340H Price gr. C137 (m ²)	431344 Price gr. C188 (m ²)	431348H Price gr. C437 (pce.)
light sand 	431329H Price gr. C308 (m ²)	431333H Price gr. C98 (m ²)	431337H Price gr. C107 (m ²)	431341H Price gr. C137 (m ²)	431345 Price gr. C188 (m ²)	431349H Price gr. C437 (pce.)
warm grey 	431330H Price gr. C308 (m ²)	431334H Price gr. C98 (m ²)	431338H Price gr. C107 (m ²)	431342H Price gr. C137 (m ²)	431346 Price gr. C188 (m ²)	431350H Price gr. C437 (pce.)
dark anthracite 	431331H Price gr. C308 (m ²)	431335H Price gr. C98 (m ²)	431339H Price gr. C107 (m ²)	431343H Price gr. C137 (m ²)	431347 Price gr. C188 (m ²)	431351H Price gr. C437 (pce.)



¹ without Hytect coating; with Protecta upgrading

³ High weight only to carry with two persons.

⁴ Please note: special pallet. No return, no exchange.

⁵ Glass fibre net on reverse side

Rendering







Natural and casual

The intended used look takes into account natural signs of wear and delicate discolorations. The wall tile is a collage of striped grains and free brush strokes. Overlays and crossings create a non-directional look which unfolds its artistic character especially in the color white – colorful.

Rendering / Architect: STELLWERK architekten, Dresden, Germany

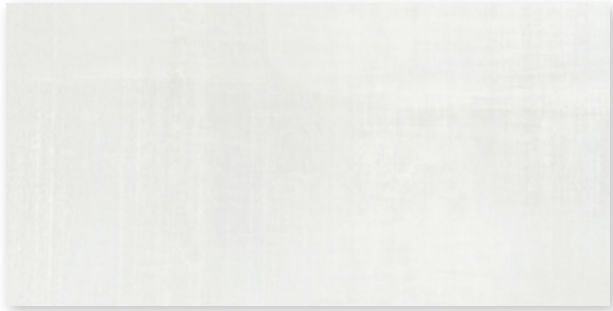

Wall tile 30 x 60 cm, 12 x 24 in, natural-white, smooth



Wall tile 30 x 60 cm, 12 x 24 in, white-colorful, smooth

Decoration elements



Border Canvas 4 x 60 cm, 1 5/8 x 24 in, grey-black, structured

Wall Tile³

30 x 60 cm

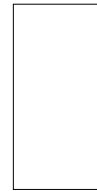

Decoration Elements^{1/2/4/5}

4 x 60 cm



Border Canvas

					30 x 60 / 12 x 24	4 x 60 / 1 5/8 x 24	Nom. dim - cm/in	
					297 x 597 x 9 mm	37 x 597 x 10.5 mm	Work size	
					smooth, silky-matt	structured, matt	Surface	
					5.556/m ²	1.667/m	m ² /m - pieces	
					14.946/m ²	0.910/m	m ² /m - kg	
					9	3	Bundle - pieces	
					1.620 m ²	1.800 m	Bundle - m ² /m	
					24.210	1.638	Bundle - kg	
					77.754		Pallet - m ²	
					1,162.080		Pallet - kg	
					BIII	Bla	Product standard	
					282901		natural white	V2
					Price gr. C89 (m ²)		white-colorful	V4
					282902		grey-black	V3
					Price gr. C89 (m ²)			
						282903		
						Price gr. C437 (pce.)		



³ not frost-proof

⁴ Only suitable for laying on the wall in indoor areas.

⁵ Decoration elements only available in full boxes.



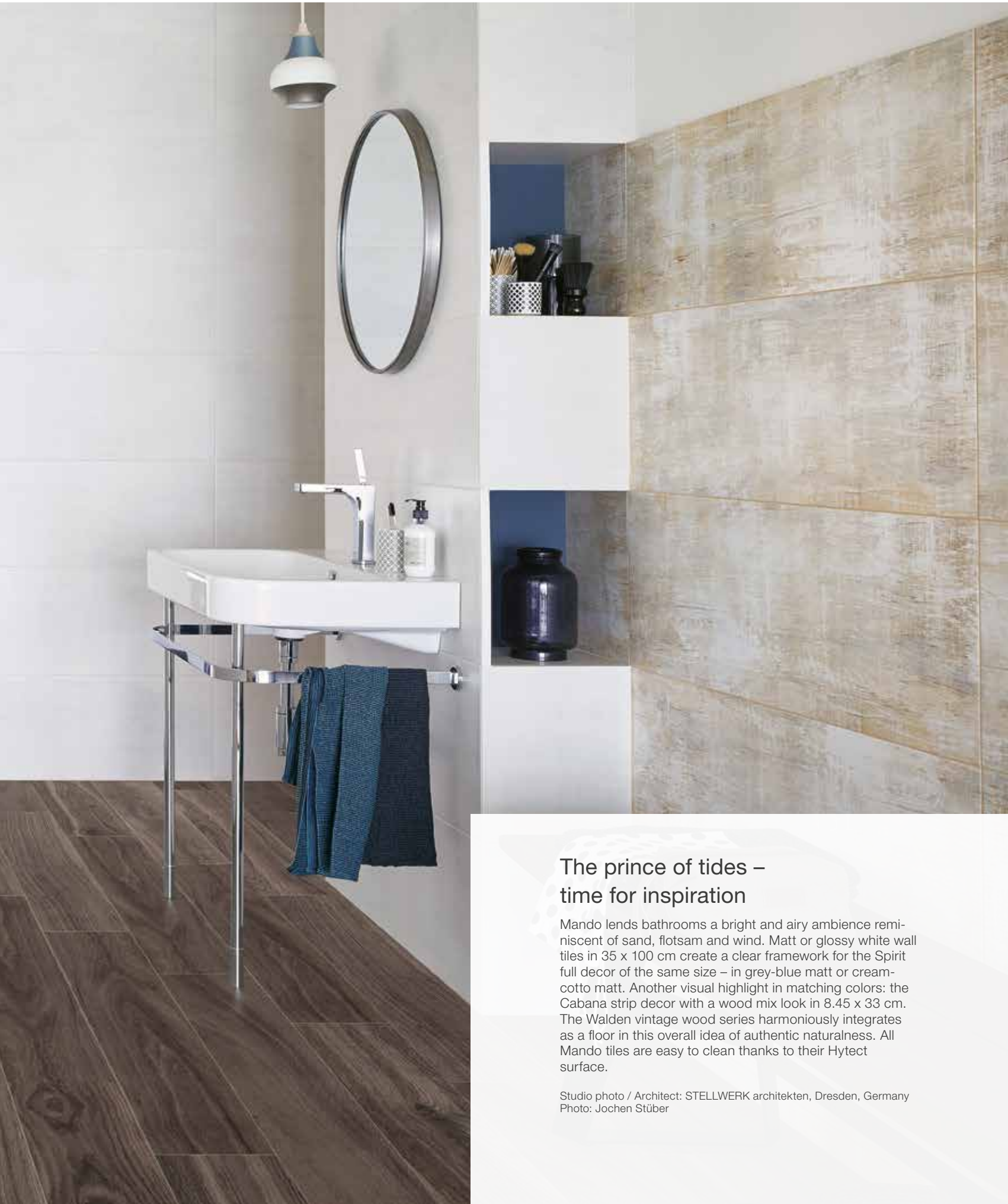

The prince of tides – time for inspiration

Mando lends bathrooms a bright and airy ambience reminiscent of sand, flotsam and wind. Matt or glossy white wall tiles in 35 x 100 cm create a clear framework for the Spirit full decor of the same size – in grey-blue matt or cream-cotto matt. Another visual highlight in matching colors: the Cabana strip decor with a wood mix look in 8.45 x 33 cm. The Walden vintage wood series harmoniously integrates as a floor in this overall idea of authentic naturalness. All Mando tiles are easy to clean thanks to their Hytect surface.

Studio photo / Architect: STELLWERK architekten, Dresden, Germany
Photo: Jochen Stüber



Wall tile 35 x 100 cm, 14 x 40 in, white

Decoration elements



Decorative element Cabana 8.45 x 33 cm, 3 13/32 x 13 13/64 in, brown-mix, smooth

The Cabana strips consciously vary in terms of color. Please combine tiles from several boxes to provide a consistent appearance.

Decoration elements



Decorative tile Spirit 35 x 100 cm, 14 x 40 in, grey-blue, smooth

Decoration elements



Decorative tile Spirit 35 x 100 cm, 14 x 40 in, cream-cotto, smooth

Wall Tile¹

Decoration Elements³

35 x 100 cm



8,45 x 33 cm²



35 x 100 cm^{1/4}



				Decorative tile Cabana	Decorative tile Spirit		
				35 x 100 / 14 x 40	8.45 x 33 /313/32x1313/64	35 x 100 / 14 x 40	Nom. dim. - cm/in
				347 x 997 x 6 mm	84.5 x 330 x 6 mm	347 x 997 x 6 mm	Work size
				smooth	smooth, silky-matt	smooth, silky-matt	Surface
				2.857/m ²	3.030/m	1.000/m	m ² /m - pieces
				10.108/m ²	0.878/m	3.538/m	m ² /m - kg
				5	18	3	Bundle - pieces
				1.750 m ²	5.940 m	3.000 m	Bundle - m ² /m
				17.690	5.220	10.614	Bundle - kg
				70.004			Pallet - m ²
				707.600			Pallet - kg
				BIII	BIII	BIII	Product standard
				363347H			white glossy <input type="checkbox"/> V3
				Price gr. W132 (m ²)			white matt <input type="checkbox"/> V3
				363348H			brown-mix <input type="checkbox"/> V4
				Price gr. W132 (m ²)			grey-blue <input type="checkbox"/> V4
					363351H		cream-cotto <input type="checkbox"/> V4
					Price gr. W421 (pce.)		
						363349H	
						Price gr. 3x W499 (pce.)	
						363350H	
						Price gr. 3x W499 (pce.)	



² The Cabana strips consciously vary in terms of color. Please combine tiles from several boxes to provide a consistent appearance.

³ Decoration elements only available in full boxes.

⁴ Set of 3 tiles





Possibilities rich in detail

While marble is usually used in large formats, the Marble & More mosaic series captivates with its almost small-scale aesthetics and varied colorfulness. Unlike its natural marble counterpart, this tile is insensitive to aggressive media such as cleaning agents, shampoos and soaps. Slip-resistant variants extend the laying freedom of planners and architects. As Hytect tiles, Marble & More are very easy to clean and they ensure hygiene. In addition, the series is color-coordinated with the Ascona series on the floor and wall.

Rendering

Mosaic 2.5 x 2.5 cm, 3/8 x 3/8 in

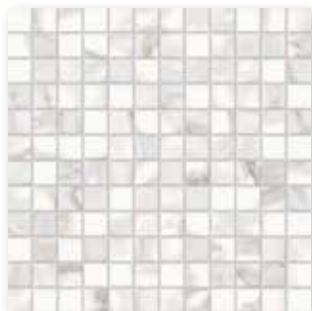

Mosaic sheet 30 x 30 cm, 12 x 12 in carrara white, smooth,
Mosaic sheet 30 x 30 cm, 12 x 12 in carrara white, smooth, R10/B



Mosaic sheet 30 x 30 cm, 12 x 12 in illusion beige, smooth,
Mosaic sheet 30 x 30 cm, 12 x 12 in illusion beige, smooth, R10/B

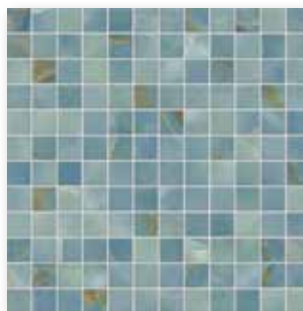

Mosaic sheet 30 x 30 cm, 12 x 12 in cielo, smooth,
Mosaic sheet 30 x 30 cm, 12 x 12 in cielo, smooth, R10/B



Mosaic sheet 30 x 30 cm, 12 x 12 in labradorit blue, smooth,
Mosaic sheet 30 x 30 cm, 12 x 12 in labradorit blue, smooth, R10/B



Mosaic sheet 30 x 30 cm, 12 x 12 in verde alpi, smooth,
Mosaic sheet 30 x 30 cm, 12 x 12 in verde alpi, smooth, R10/B

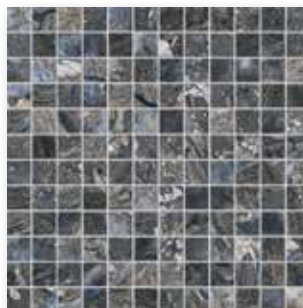

Mosaic sheet 30 x 30 cm, 12 x 12 in illusion dark, smooth,
Mosaic sheet 30 x 30 cm, 12 x 12 in illusion dark, smooth, R10/B



Mosaics glued thermoplastically on back of Agrob Buchtal can be used not only in dry zones but also without any problems in underwater areas (e.g. swimming pools/whirlpools) as well as in permanently wet areas.

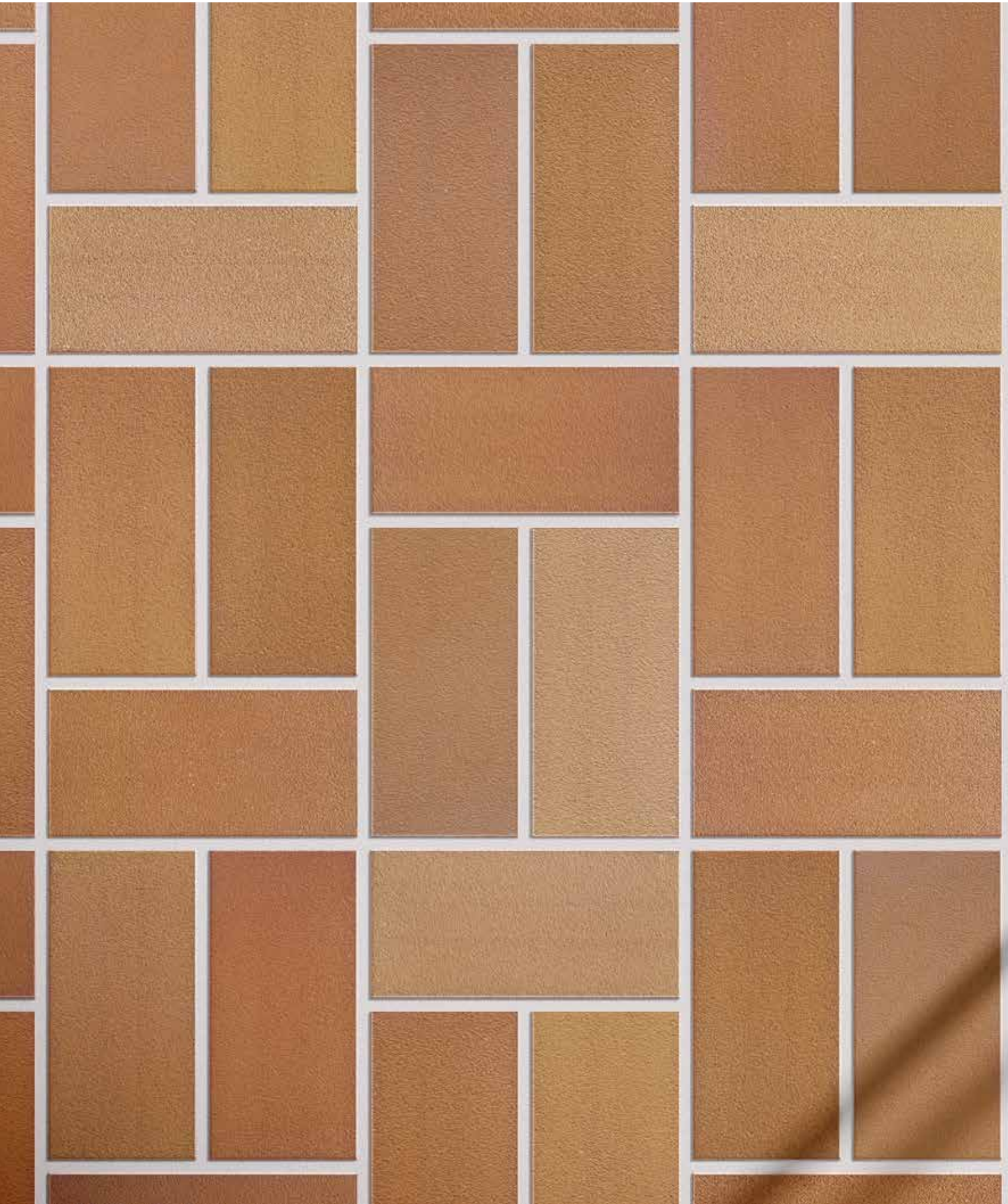

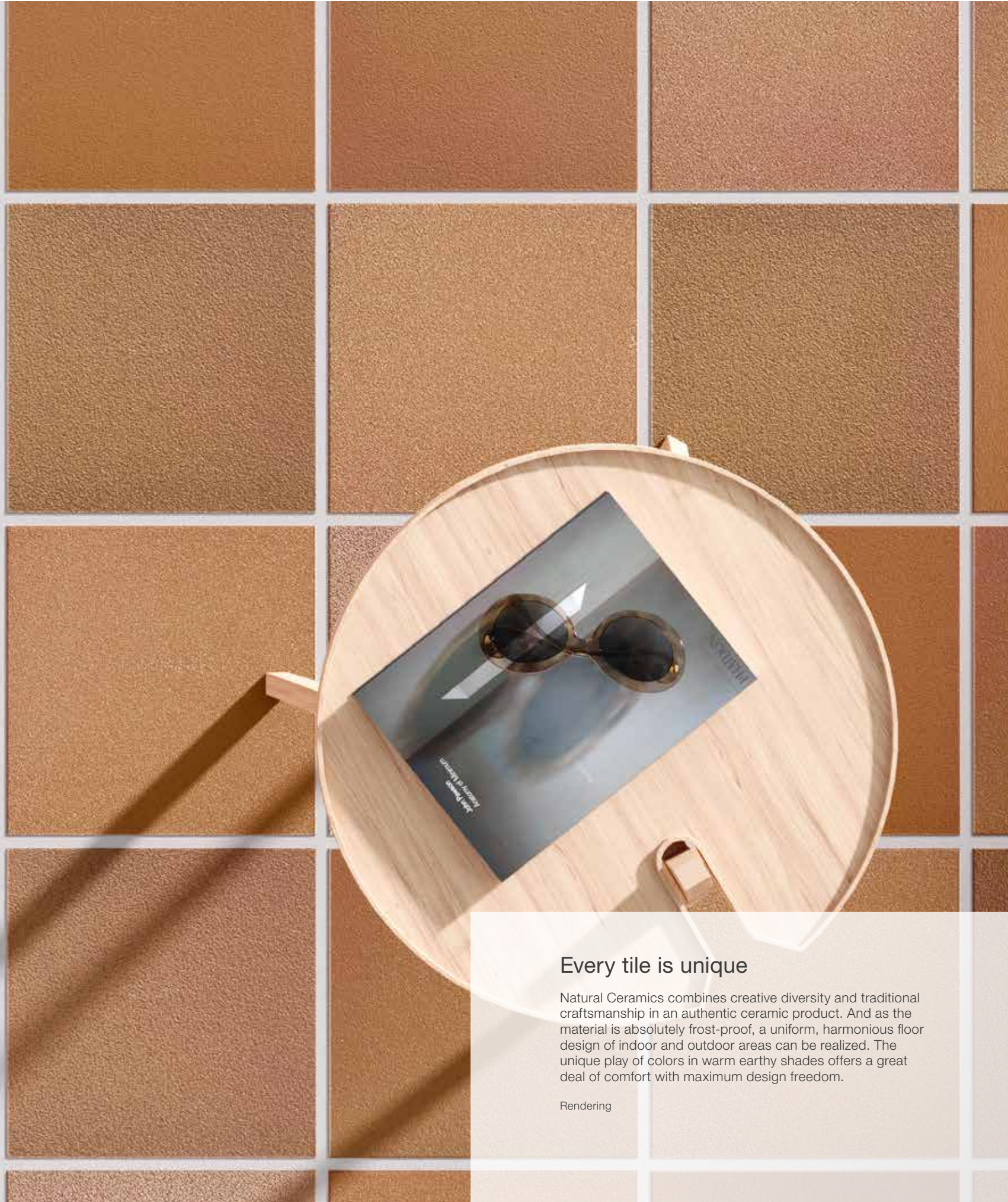

Every tile is unique

Natural Ceramics combines creative diversity and traditional craftsmanship in an authentic ceramic product. And as the material is absolutely frost-proof, a uniform, harmonious floor design of indoor and outdoor areas can be realized. The unique play of colors in warm earthy shades offers a great deal of comfort with maximum design freedom.

Rendering



R11/A R11/B



autumn leaves



portofino



colorado-brown



Floor tile 12.5 x 25 cm, 5 x 10 in, smooth, R11/A
Floor tile 12.5 x 25 cm, 5 x 10 in, smooth, R11/B



Floor tile 25 x 25 cm, 10 x 10 in, smooth, R11/A
Floor tile 25 x 25 cm, 10 x 10 in, smooth, R11/B

Floor Tiles

12.5 x 25 cm



25 x 25 cm

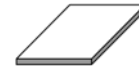

					1010	1630	Model number
					12.5 x 25 / 5 x 10	25 x 25 / 10 x 10	Nom. dim. - cm/in
					115 x 240 x 10 mm	240 x 240 x 10 mm	Work size
					smooth, matt	smooth, matt	Surface
					33.000/m ²	16.000/m ²	m² - pieces
					19.800/m ²	20.160/m ²	m² - kg
					26	11	Bundle - pieces
					0.788 m ²	0.688 m ²	Bundle - m ²
					15.600	13.860	Bundle - kg
					66.182	55.688	Pallet - m ²
					1,310.400	1,122.600	Pallet - kg
					Alla	Alla	Product standard
					see below	see below	Slip resistance
					2	2	Stres group
					R11/B	R11/B	
					010D-1010	010D-1630	autumn leaves <input type="checkbox"/> V3
					Price gr. A109 (m ²)	Price gr. A124 (m ²)	
					R11/A	R11/A	portofino <input type="checkbox"/> V4
					948D-1010	948D-1630	
					Price gr. A109 (m ²)	Price gr. A124 (m ²)	
					R11/B	R11/B	colorado-brown <input type="checkbox"/> V4
					950D-1010	950D-1630	
					Price gr. A109 (m ²)	Price gr. A124 (m ²)	

The nosing tiles 12.5 x 25 cm can be produced with glued edge on request. The price is calculated project-specifically.







Endurance test: withstanding any pressure

Floors in supermarkets should be attractive, easy to clean and extremely robust. Agrob Buchtal meets these requirements with extra thick tiles in thicknesses of up to 14 mm. With breaking strength values which are considerably higher than required by the relevant standards, the rectified large formats also withstand the loads caused by driving forklift trucks and pallet trucks without any problems. At the same time, extreme robustness is combined with an attractive look: porcelain stoneware surfaces in a wide range of colors offer all the prerequisites for a representative design.

Design Area Pro



pebble



sand-white



sand-grey



Floor tile 60 x 60 cm, 24 x 24 in, extra thick, smooth, R10



Design Basis Pro



concrete-grey



ash-brown



sand-beige

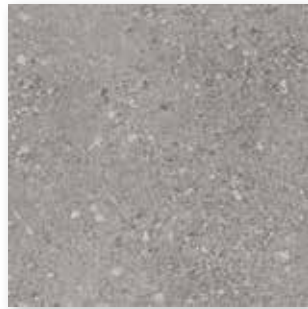

Floor tile 30 x 30 cm, 12 x 12 in, extra thick, smooth, R10



Floor tile 30 x 60 cm, 12 x 24 in, extra thick, smooth, R10

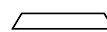

Floor tile 60 x 60 cm, 24 x 24 in, extra thick, smooth, R10

 The formats 30 x 60 cm, 12 x 24 in and 60 x 60 cm, 24 x 24 in are conically rectified.



R10



Design Like



cement

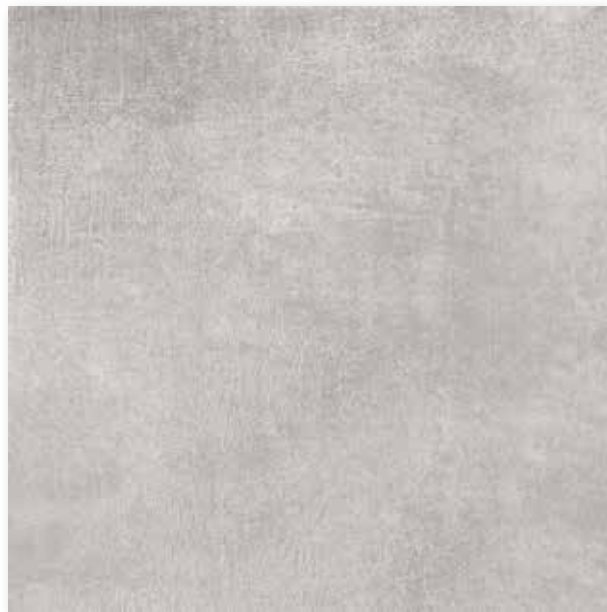

Floor tile 60 x 60 cm, 24 x 24 in, extra thick, structured, R10

Design Portland



anthracite



Floor tile 30 x 30 cm, 12 x 12 in, extra thick, smooth, R10

 The formats 30 x 60 cm, 12 x 24 in and 60 x 60 cm, 24 x 24 in are conically rectified.



Design Trio



Terrazzo black



Terrazzo red



Terrazzo ivory

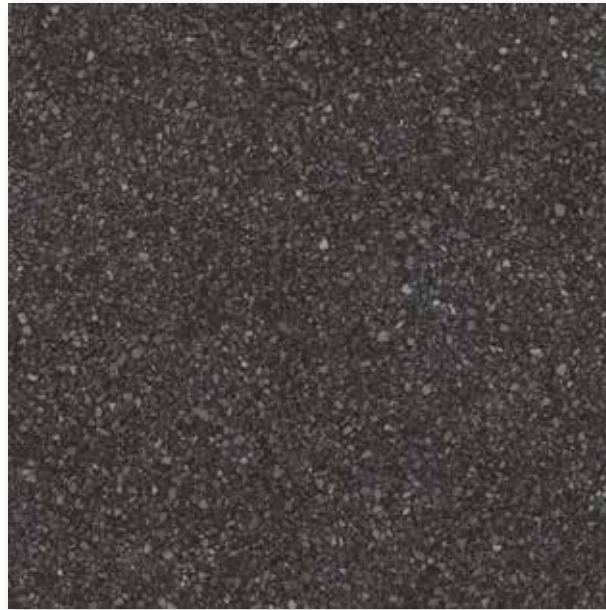

Floor tile 60 x 60 cm, 24 x 24 in, extra thick, smooth, R10

Design Walden



classic oak



relax beige



smokey brown



Floor tile 30 x 60 cm, 12 x 24 in, extra thick, structured, R10

 The formats 30 x 60 cm, 12 x 24 in and 60 x 60 cm, 24 x 24 in are conically rectified.

Floor Tiles²

30 x 30 cm



30 x 30 cm



30 x 60 cm¹

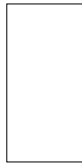

30 x 60 cm¹



60 x 60 cm¹

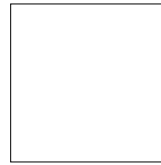

60 x 60 cm^{1/3}



60 x 60 cm¹

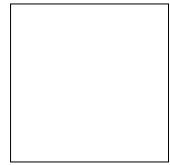

protected

	<i>Design Portland</i>	<i>Design Basis Pro</i>	<i>Design Basis Pro</i>	<i>Design Walden</i>	<i>Design Basis Pro</i>	<i>Design Area Pro</i>	<i>Design Like</i>
Nom. dim. - cm/in	30 x 30 / 12 x 12	30 x 30 / 12 x 12	30 x 60 / 12 x 24	30 x 60 / 12 x 24	60 x 60 / 24 x 24	60 x 60 / 24 x 24	60 x 60 / 24 x 24
Work size	297 x 297 x 14 mm	297 x 297 x 14 mm	300 x 600 x 14 mm	300 x 600 x 14 mm	600 x 600 x 14 mm	600 x 600 x 14 mm	600 x 600 x 14 mm
Surface	smooth, matt	smooth, matt	smooth, matt	structured, matt	smooth, matt	smooth, matt	structured, matt
m ² - pieces	11.337	11.337	5.589	5.589	2.778	2.778	2.778
m ² - kg	32.027	32.027	32.159	32.159	31.669	31.669	31.669
Bundle - pieces	8	8	4	4	2	2	2
Bundle - m ²	0.706	0.706	0.716	0.716	0.720	0.720	0.720
Bundle - kg	22.600	22.600	23.016	23.016	22.800	22.800	22.800
Pallet - m ²	33.871	33.871	28.628	28.628	30.238	30.238	30.238
Pallet - kg	1,084.800	1,084.800	920.640	920.640	957.600	957.600	957.600
Product standard	Bla	Bla	Bla	Bla	Bla	Bla	Bla
Slip resistance	R10	R10	R10	R10	R10	R10	R10
Stress group	4	4	3	3	4	4	4
Portland	434194						
anthracite <input type="checkbox"/> V3							
Basis Pro		430993	430995		430977		
concrete-grey <input type="checkbox"/> V2							
Basis Pro			430996		430978		
ash-brown <input type="checkbox"/> V2							
Basis Pro			430997		430979		
sand-beige <input type="checkbox"/> V2							
Walden				432292			
classic oak <input type="checkbox"/> V2							
Walden				432293			
relax beige <input type="checkbox"/> V2							
Walden				432294			
smokey brown <input type="checkbox"/> V2							
Area Pro						430200H	
pebble <input type="checkbox"/> V2							
Area Pro						430201H	
sand-white <input type="checkbox"/> V2							
Area Pro						430202H	
sand-grey <input type="checkbox"/> V2							
Like							430684
cement <input type="checkbox"/> V2							

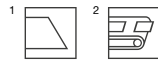

³ with Hytect coating

Prices are calculated project-specifically.

Floor Tile^{1/2}

60 x 60 cm

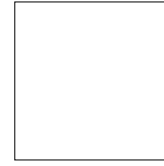

Design Trio

						60 x 60 / 24 x 24	Nom. dim. - cm/in
						600 x 600 x 14 mm	Work size
						structured, matt	Surface
						2.778	m² - pieces
						31.669	m² - kg
						2	Bundle - pieces
						0.720	Bundle - m ²
						22.800	Bundle - kg
						30.238	Pallet - m ²
						957.600	Pallet - kg
						Bla	Product standard
						R10	Slip resistance
						4	Stress group
						431692H	Trio
						431693H	terrazzo red <input type="checkbox"/> V4
						431694H	Trio
							terrazzo black <input type="checkbox"/> V4
							Trio
							terrazzo ivory <input type="checkbox"/> V4



Prices are calculated project-specifically.



Nivella levelling mat 30 x 60 cm, 12 x 24 in

Nivella levelling mat

Nivella mats solve the problem of levelling height differences between mosaics (6.5 mm) and wall and floor tiles (8 mm). They therefore ensure a consistently even surface conveying a perfect sensation of space. Nivella is ideal for working with small-format tiles and suitable for use in both indoor and outdoor applications. Another advantage is of an acoustic nature: Nivella effectively minimizes any hollow-sounding effects. Cut to the required size, the mat is pressed fully into the tile adhesive.

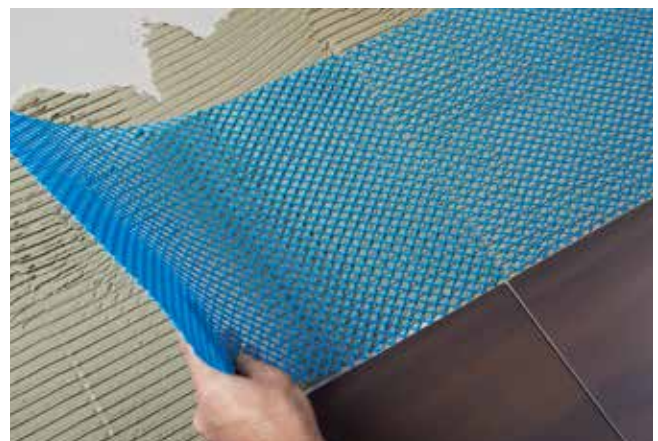

Levelling Mat

30 x 60 cm



						30 x 60 / 12 x 24	Nom. dim. - cm/in
						316 x 632 x 2.5 mm	Work size
						5 sheets	Surface
						0.380	m² - pieces
						5 sheets	m² - kg
						1.000	Bundle - pieces
						0.380	Bundle - m ²
						30.000	Bundle - kg
						11.400	Pallet - m ²
							Pallet - kg
							Product standard
							Slip resistance
						0002	
						Price gr. A22 (m ²)	blue

Technical data
 Fire class: B2
 Load resistance: 2 KN/m² (category A1-B1)
 Spot load for tiles in 1 x 1 cm format:
 not greater than 0,25 KN/cm²
 (approx. 25 kg/cm²)

Special conditions for accessories

Levelling mat for commercial and private use in indoor and outdoor applications (walls / floors)

Features:

- Levelling
- Especially under small-format coverings
- No hollow sound
- High tensile bond strength

Product description:

Nivella is a special levelling mat which is ideal for combining mosaics (6.5 mm) with the wall and floor tiles (8 mm). High tensile bond strength as well as bending, tensile and compressive strength are the distinctive performance features of this levelling mat.

Surfaces:

The surfaces on which Nivella is used must be examined for evenness, loadbearing capacity and surface strength. Differences in floor levels must be eliminated. Adhesion-inhibiting layers must be removed by grinding. Primers co-ordinated to the surface, grout and/or levelling layers must also be used.

Compensation filling and levelling – including for the adjacent coverings – must be performed prior to fitting the levelling mat. Surfaces which are sensitive to moisture must be protected by performing the appropriate sealing measures.

- Cement-based surfaces such as screed or concrete must be at least 28 days old; new screed up to 7 days after accessibility.
- Calcium sulphate screed with residual moisture < 1%
- Poured asphalt screed
- Magnesia/Stonewood screed
- Heated screed
- Dry screed
- Old, firm ceramic coverings
- Old natural stone coverings
- Plasterboard
- Fibre cement boards
- Plaster

Installation:

Apply suitable tile adhesive to the prepared surface in accordance with DIN EN 12004 C2 and DIN EN 12002 S1. Nivella mats are cut to the required size, fully embedded in the adhesive and laid edge to edge. The tile adhesive is filled consistently in the grooves (mesh structure). The mesh cavities must be 100% filled. Using the corresponding toothed bar, comb out the adhesive and lay the mosaics. At the earliest after 24 hours, the areas are grouted using a polymer-modified mortar.

Attention:

The correct and therefore successful application of our products is beyond our control. A guarantee can therefore only be given for the quality of our products within the framework of our terms and conditions governing sale and delivery but not for successful installation thereof. We retain the right to modifications representing technical progress.

Vertical payloads for ceilings to DIN 1055-3 (excerpt)				
Category	Application	Examples	Distributed load qk (kN/m ²)	Point load Qk (kN)
A1	Attics	Attic space to clear height of 1.8 m	1.0	1.0
A2	Residential and recreational applications	Rooms with sufficient lateral load distribution such as rooms and corridors in residential buildings, hotel rooms and hospital wards	1.5	–
A3		As for A2 but without sufficient lateral distribution	2.0	1.0
B1	Office and working areas	Corridors in office buildings, office space, doctors' surgeries, wards, recreational rooms incl. corridors, stables	2.0	2.0



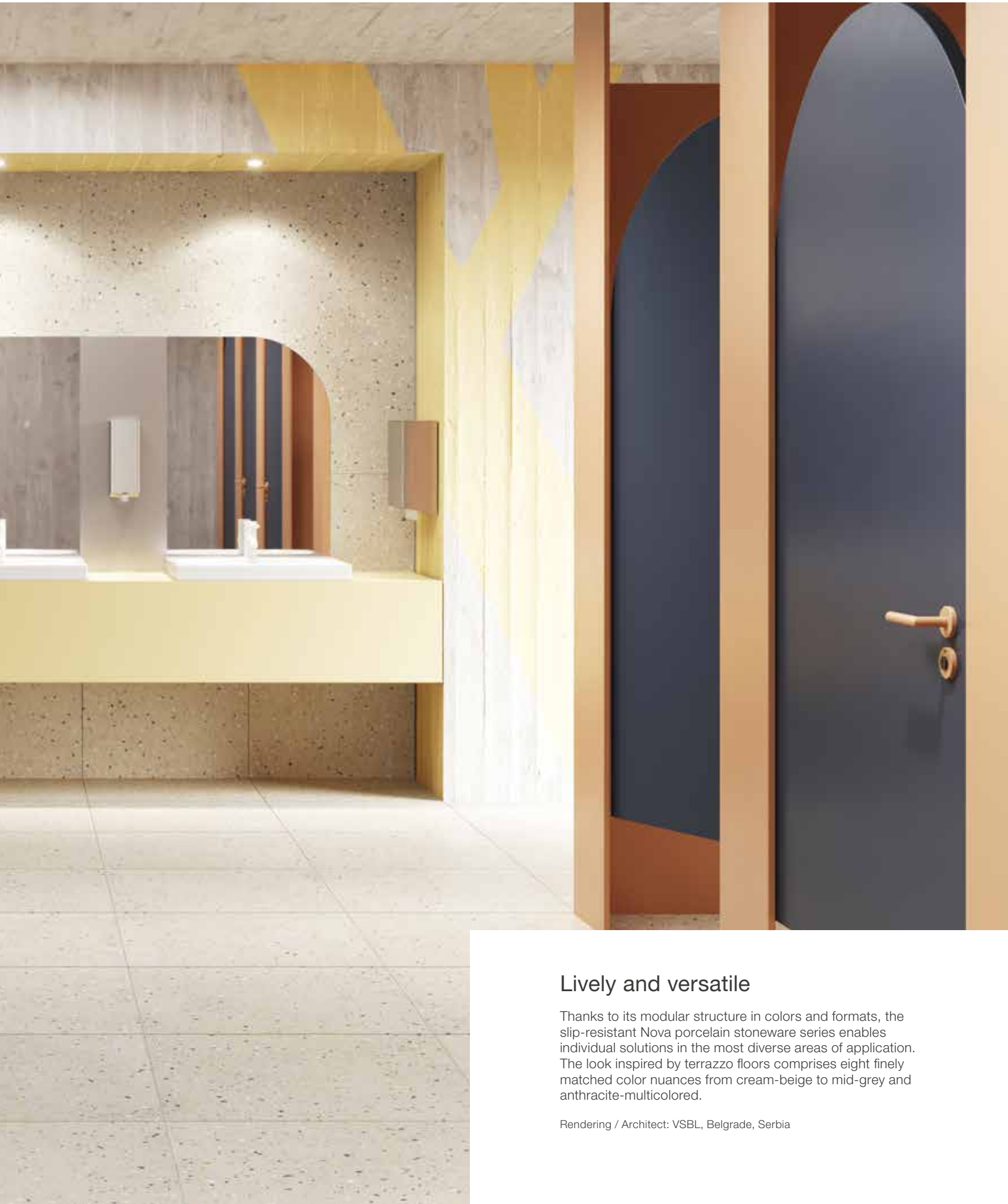

Lively and versatile

Thanks to its modular structure in colors and formats, the slip-resistant Nova porcelain stoneware series enables individual solutions in the most diverse areas of application. The look inspired by terrazzo floors comprises eight finely matched color nuances from cream-beige to mid-grey and anthracite-multicolored.

Rendering / Architect: VSBL, Belgrade, Serbia



cream-beige



mid-brown



mid-grey



basalt



anthracite



cream-beige-multicolored



mid-grey-multicolored



anthracite-multicolored



Floor tile 15 x 15 cm, 6 x 6 in, smooth, R10/B
Floor tile 15 x 15 cm, 6 x 6 in, smooth, R11/C



Oblong format 10 x 60 cm, 4 x 24 in, smooth, R10/A



Oblong format 15 x 60 cm, 6 x 24 in, smooth, R10/A



Floor tile 30 x 60 cm, 12 x 24 in, smooth, R10/A
Floor tile 30 x 60 cm, 12 x 24 in, smooth, R11/B



Floor tile 60 x 60 cm, 24 x 24 in, smooth, R10/A



Floor tile 60 x 120 cm, 24 x 48 in, smooth, R10/A



R10/A R10/B



Mosaic
5 x 5 cm, 2 x 2 in



cream-beige



anthracite



mid-brown



cream-beige-multicolored



mid-grey



mid-grey-multicolored



basalt

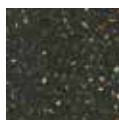

anthracite-multicolored



Stair tile 30 x 60 cm, 12 x 24 in (with grooves), smooth, R10/A

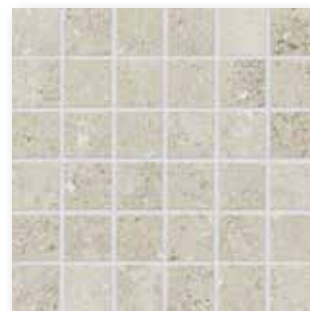

Mosaic sheet 30 x 30 cm, 12 x 12 in, smooth, R10/B



Cove skirting 10 x 60 cm, 4 x 24 in, smooth



Skirting, rounded 7 x 60 cm, 2 13/16 x 24 in, smooth



Stair tile with bevel 31 x 145 cm, 12 13/64 x 57 in, smooth, R10/A



Riser 28 x 145, 11.2 x 57 in, smooth

Mosaic: Glass fibre net on reverse side,
Sheet: 297 x 297 mm

Mosaic^{1/3}

Floor Tiles

5 x 5 cm



15 x 15 cm



15 x 15 cm



10 x 60 cm^{1/2}



15 x 60 cm^{1/2}



Sheet: 297 x 297 mm

Oblong format

Oblong format

	5 x 5 / 2 x 2	15 x 15 / 6 x 6	15 x 15 / 6 x 6	10 x 60 / 4 x 24	15 x 60 / 6 x 24	
	47 x 47 x 10.5 mm	147 x 147 x 8 mm	147 x 147 x 8 mm	97 x 597 x 10.5 mm	147 x 597 x 10.5 mm	Nom. dim. - cm/in
	smooth, matt	smooth, matt	smooth, matt	smooth, matt	smooth, matt	Work size
	11.111 sheets	44.444	44.444	16.667	11.111	Surface
	21.966	17.555	17.555	21.967	21.966	m ² - pieces
	11 sheets	35	35	15	11	m ² - kg
	0.990	0.788	0.788	0.900	0.990	Bundle - pieces
	21.747	13.825	13.825	19.770	21.747	Bundle - m ²
	29.700	63.001	63.001	35.999	39.600	Bundle - kg
	652.410	1,106.000	1,106.000	790.800	869.880	Pallet - m ²
	Ala	Bla	Bla	Ala	Ala	Pallet - kg
	R10/B	R10/B	R11/C	R10/A	R10/A	Product standard
	2	2	2	2	2	Slip resistance
	431801H	431807H	431873H	<i>431817H</i>	<i>431823H</i>	Stress group
	Price gr. A286 (m ²)	Price gr. A142 (m ²)	Price gr. A157 (m ²)	<i>Price gr. A199</i> (m ²)	<i>Price gr. A199</i> (m ²)	cream-beige <input type="checkbox"/> V3
	431802H	431808H	431874H	<i>431818H</i>	<i>431824H</i>	mid-brown <input type="checkbox"/> V3
	Price gr. A286 (m ²)	Price gr. A142 (m ²)	Price gr. A157 (m ²)	<i>Price gr. A199</i> (m ²)	<i>Price gr. A199</i> (m ²)	
	431803H	431809H	431875H	<i>431819H</i>	<i>431825H</i>	medium grey <input type="checkbox"/> V3
	Price gr. A286 (m ²)	Price gr. A142 (m ²)	Price gr. A157 (m ²)	<i>Price gr. A199</i> (m ²)	<i>Price gr. A199</i> (m ²)	
	431804H	431810H	431876H	<i>431820H</i>	<i>431826H</i>	basalt <input type="checkbox"/> V3
	Price gr. A286 (m ²)	Price gr. A142 (m ²)	Price gr. A157 (m ²)	<i>Price gr. A199</i> (m ²)	<i>Price gr. A199</i> (m ²)	
	431805H	431811H	431877H	<i>431821H</i>	<i>431827H</i>	anthracite <input type="checkbox"/> V3
	Price gr. A286 (m ²)	Price gr. A142 (m ²)	Price gr. A157 (m ²)	<i>Price gr. A199</i> (m ²)	<i>Price gr. A199</i> (m ²)	
	431744H			<i>431746H</i>	<i>431748H</i>	cream-beige <input type="checkbox"/> V4
	Price gr. A286 (m ²)			<i>Price gr. A199</i> (m ²)	<i>Price gr. A199</i> (m ²)	multicolored <input type="checkbox"/> V4
	431745H			<i>431747H</i>	<i>431749H</i>	mid-grey <input type="checkbox"/> V4
	Price gr. A286 (m ²)			<i>Price gr. A199</i> (m ²)	<i>Price gr. A199</i> (m ²)	multicolored <input type="checkbox"/> V4
	431806H			<i>431822H</i>	<i>431828H</i>	anthracite <input type="checkbox"/> V4
	Price gr. A286 (m ²)			<i>Price gr. A199</i> (m ²)	<i>Price gr. A199</i> (m ²)	multicolored <input type="checkbox"/> V4



³ Glass fibre net on reverse side



Floor Tiles¹

30 x 60 cm



30 x 60 cm

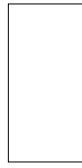



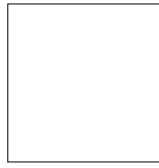



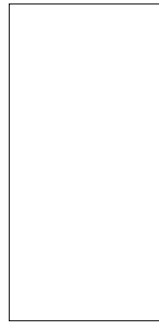



60 x 60 cm²



60 x 120 cm²



Nom. dim. - cm/in	30 x 60 / 12 x 24	30 x 60 / 12 x 24	60 x 60 / 24 x 24	60 x 120 / 24 x 48			
Work size	297 x 597 x 10.5 mm	297 x 597 x 10.5 mm	597 x 597 x 10.5 mm	597 x 1197 x 10.5 mm			
Surface	smooth, matt	smooth, matt	smooth, matt	smooth, matt			
m ² - pieces	5.556	5.556	2.778	1.388			
m ² - kg	21.974	21.974	21.996	21.996			
Bundle - pieces	6	6	3	2			
Bundle - m ²	1.080	1.080	1.080	1.441			
Bundle - kg	23.730	23.730	23.754	31.672			
Pallet - m ²	43.197	43.197	32.397	30.259			
Pallet - kg	949.200	949.200	712.620	665.112			
Product standard	Ala	Ala	Ala	Ala			
Slip resistance	R10/A	R11/B	R10/A	R10/A			
Stress group	2	2	2	2			
cream-beige 	431829H Price gr. A121 (m ²)	431835H Price gr. A154 (m ²)	431840H Price gr. A136 (m ²)	431846H Price gr. A154 (m ²)			
mid-brown 	431830H Price gr. A121 (m ²)	431836H Price gr. A154 (m ²)	431841H Price gr. A136 (m ²)	431847H Price gr. A154 (m ²)			
medium grey 	431831H Price gr. A121 (m ²)	431837H Price gr. A154 (m ²)	431842H Price gr. A136 (m ²)	431848H Price gr. A154 (m ²)			
basalt 	431832H Price gr. A121 (m ²)	431838H Price gr. A154 (m ²)	431843H Price gr. A136 (m ²)	431849H Price gr. A154 (m ²)			
anthracite 	431833H Price gr. A121 (m ²)	431839H Price gr. A154 (m ²)	431844H Price gr. A136 (m ²)	431850H Price gr. A154 (m ²)			
cream-beige 	431750H Price gr. A121 (m ²)		431752H Price gr. A136 (m ²)	431754H Price gr. A154 (m ²)			
multicolored 	431751H Price gr. A121 (m ²)		431753H Price gr. A136 (m ²)	431755H Price gr. A154 (m ²)			
mid-grey 	431834H Price gr. A121 (m ²)		431845H Price gr. A136 (m ²)	431851H Price gr. A154 (m ²)			
anthracite 							
multicolored 							



² High weight only to carry with two persons.

Stair Tile^{2/4}

Stair Tile with Bevel^{2/3/4}

Riser^{2/3/4}

Skirting, rounded¹

Cove Skirting, decorated^{1/2/5}

30 x 60 cm

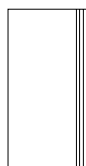

31 x 145 cm



28 x 145 cm



7 x 60 cm



10 x 60 cm



	30 x 60 / 12 x 24	31 x 145 / 12 13/64 x 57	28 x 145 / 11 x 57	7 x 60 / 2 13/16 x 24	10 x 60 / 4 x 24	Nom. dim. - cm/in
	297 x 597 x 10.5 mm	307 x 1447 x 10.5 mm	280 x 1447 x 10.5 mm	70 x 597 x 10.5 mm	100 x 597/35 x 9 mm	Work size
	smooth, matt	smooth, matt	smooth, matt	smooth, matt	smooth, matt	Surface
	1.667	0.690	0.690	1.667	1.667	m - pieces
	6.593	7.480	6.716	1.554	2.000	m - kg
	6	2	2	15	20	Bundle - pieces
	3.599 m	2.899 m	2.899 m	8.998	11.998	Bundle - m ² /m
	23.730	21.682	19.466	13.980	24.000	Bundle - kg
						Pallet - m ²
						Pallet - kg
	Ala	Ala	Ala	Ala	Alb	Product standard
	R10/A	R10/A	R10/A			Slip resistance
	2	2	2			Stress group
	431852H	431797H	431785H	431864H	431887H	cream-beige <input type="checkbox"/> V3
	Price gr. A475 (pce.)	Price gr. A560 (pce.)	Price gr. A528 (pce.)	Price gr. A438 (pce.)	Price gr. A445 (pce.)	
	431853H	431715H	431719H	431865H	431893H	mid-brown <input type="checkbox"/> V3
	Price gr. A475 (pce.)	Price gr. A560 (pce.)	Price gr. A528 (pce.)	Price gr. A438 (pce.)	Price gr. A445 (pce.)	
	431854H	431736H	431765H	431866H	431894H	medium grey <input type="checkbox"/> V3
	Price gr. A475 (pce.)	Price gr. A560 (pce.)	Price gr. A528 (pce.)	Price gr. A438 (pce.)	Price gr. A445 (pce.)	
	431855H	431794H	431727H	431867H	431786H	basalt <input type="checkbox"/> V3
	Price gr. A475 (pce.)	Price gr. A560 (pce.)	Price gr. A528 (pce.)	Price gr. A438 (pce.)	Price gr. A445 (pce.)	
	431856H	430599H	431720H	431868H	431787H	anthracite <input type="checkbox"/> V3
	Price gr. A475 (pce.)	Price gr. A560 (pce.)	Price gr. A528 (pce.)	Price gr. A438 (pce.)	Price gr. A445 (pce.)	
	431756H	431716H	431721H	431762H		cream-beige <input type="checkbox"/> V4
	Price gr. A475 (pce.)	Price gr. A560 (pce.)	Price gr. A528 (pce.)	Price gr. A438 (pce.)		
	431757H	431717H	431722H	431763H		mid-grey <input type="checkbox"/> V4
	Price gr. A475 (pce.)	Price gr. A560 (pce.)	Price gr. A528 (pce.)	Price gr. A438 (pce.)		
	431857H	431718H	431723H	431869H		multicolored <input type="checkbox"/> V4
	Price gr. A475 (pce.)	Price gr. A560 (pce.)	Price gr. A528 (pce.)	Price gr. A438 (pce.)		
						anthracite <input type="checkbox"/> V4
						multicolored <input type="checkbox"/> V4



¹ Rectified only on the two short sides. The long side can not be rectified.

² For details, refer to page 538. For more solutions concerning stair design, refer to the series Area Pro.

³ Color deviations compared to the adjoining covering due to production are no reason for complaint in case of horizontal laying.

310 Oak





Easy-care wood look

Oak achieves an elegant and refined wood look – both in the natural and the anthracite variant. The floor series offers 5 different sizes, stair elements, skirtings and a hexagonal floor décor in 30 x 35 cm – all of them with Hytect surface – for plenty of design freedom with a uniform look. A modern touch is provided by three panel formats measuring 30 x 120, 40 x 120 and 60 x 120 cm. These large formats show the grain to its best advantage.

Studiophoto



natural oak



oak anthracite



Floor tile 15 x 90 cm, 6 x 36 in, structured, R10/A



Floor tile 30 x 90 cm, 12 x 36 in, structured, R10/A



Floor tile 30 x 120 cm, 12 x 48 in, structured, R10/A



Floor tile 40 x 120 cm, 16 x 48 in, structured, R10/A



Floor tile 60 x 120 cm, 24 x 48 in, structured, R10/A



Stair tile 30 x 120 cm, 12 x 48 in (with grooves), structured, R10/A



Skirting, rounded 6 x 60 cm, 2 3/8 x 24 in, structured

Decoration elements



Decorative tile Hexagon 30 x 35 cm, 12 x 14 in, natural oak, structured, R10/A



Decorative tile Hexagon 30 x 35 cm, 12 x 14 in, anthracite oak, structured, R10/A

Glass fibre net on reverse side,
Sheet: 298 x 344.1 mm.

Decoration Elements³

30 x 35 cm



Decorative tile Hexagon
Sheet: 298 x 344,1 mm



Nom. dim. - cm/in	30 x 35 / 12 x 14						
Work size	298 x 344.1 x 8 mm						
Surface	structured, matt						
m - pieces	3.333						
m - kg	4.166						
Bundle - pieces	3						
Bundle - m	0.900						
Bundle - kg	3.750						
Product standard	Alb						
Slip resistance	R10/A						
Stress group	2						
natural oak <input type="checkbox"/> V4	8471-B698HK Price gr. W518 (pce.)						
anthracite oak <input type="checkbox"/> V3	8472-B698HK Price gr. W518 (pce.)						



Floor Tiles¹

Stair Tile^{1/2}

Skirting, rounded¹

15 x 90 cm²



30 x 90 cm



30 x 120 cm



40 x 120 cm



60 x 120 cm⁴



30 x 120 cm



6 x 60 cm



Nom. dim. - cm/in	15 x 90 / 6 x 36	30 x 90 / 12 x 36	30 x 120 / 12 x 48	40 x 120 / 16 x 48	60 x 120 / 24 x 48	30 x 120 / 12 x 48	6 x 60 / 2 3/8 x 24
Work size	147 x 897 x 8 mm	297 x 897 x 8 mm	297 x 1197 x 8 mm	397 x 1197 x 8 mm	597 x 1197 x 8 mm	297 x 1197 x 8 mm	60 x 597 x 8 mm
Surface	structured, matt	structured, matt	structured, matt	structured, matt	structured, matt	structured, matt	structured, matt
m ² /m - pieces	7.407/m ²	3.704/m ²	2.778/m ²	2.083/m ²	1.388/m ²	0.833/m	1.667/m
m ² /m - kg	17.495/m ²	17.501/m ²	17.501/m ²	17.497/m ²	17.489/m ²	5.248/m	1.100/m
Bundle - pieces	8	5	4	3	2	4	27
Bundle - m ² /m	1.080 m ²	1.350 m ²	1.440 m ²	1.440 m ²	1.441 m ²	4.802 m	16.197 m
Bundle - kg	18.896	23.625	25.200	25.200	25.200	25.200	17.820
Pallet - m ²	43.202	40.497	43.197	51.848	36.023		
Pallet - kg	755.840	708.750	756.000	907.200	630.000		
Product standard	Alb	Alb	Alb	Alb	Alb	Alb	Alb
Slip resistance	R10/A	R10/A	R10/A	R10/A	R10/A	R10/A	
Stress group	2	2	2	2	2	2	
natural oak <input type="checkbox"/> V4	8471-B695HK Price gr. W171 (m ²)	8471-B690HK Price gr. W162 (m ²)	8471-B620HK Price gr. W171 (m ²)	8471-B660HK Price gr. W171 (m ²)	8471-B670HK Price gr. W171 (m ²)	8471-B629HK Price gr. W559 (pce.)	8471-B610HK Price gr. W439 (pce.)
anthracite oak <input type="checkbox"/> V3	8472-B695HK Price gr. W171 (m ²)	8472-B690HK Price gr. W162 (m ²)	8472-B620HK Price gr. W171 (m ²)	8472-B660HK Price gr. W171 (m ²)	8472-B670HK Price gr. W171 (m ²)	8472-B629HK Price gr. W559 (pce.)	8472-B610HK Price gr. W439 (pce.)



³ Decoration elements only available in full boxes.
⁴ High weight only to carry with two persons.

Studio photo







Sea of colors

The Ocean series offers a diverse color range for pools, spas and wellness areas, which reflects the element of water in all its vibrancy. Delicate cloud and fine-grained structures blend with the shimmer of the sun reflections. By means of digital printing and glaze pigments, iridescent colors such as crystal-clear green, caribbean turquoise or deep blue are created. The formats in oblong and mosaic look are suitable for atmospheric and functional pool designs and perfectly complement series such as ChromaPlural.

Rendering

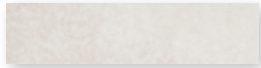

Wall tile 6.2 x 25 cm, 2 1/2 x 10 in
sunset beige, smooth



Wall tile 6.2 x 25 cm, 2 1/2 x 10 in
wave blue, smooth

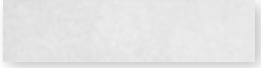

Wall tile 6.2 x 25 cm, 2 1/2 x 10 in
cliff white, smooth



Wall tile 6.2 x 25 cm, 2 1/2 x 10 in
atlantic blue, smooth

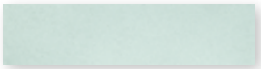

Wall tile 6.2 x 25 cm, 2 1/2 x 10 in
crystal green, smooth



Wall tile 6.2 x 25 cm, 2 1/2 x 10 in
pacific blue, smooth

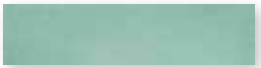

Wall tile 6.2 x 25 cm, 2 1/2 x 10 in
island green, smooth



Wall tile 6.2 x 25 cm, 2 1/2 x 10 in
moos green, smooth

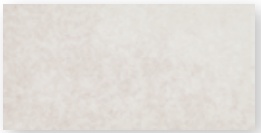

Wall tile 12.5 x 25 cm, 5 x 10 in
sunset beige, smooth



Wall tile 12.5 x 25 cm, 5 x 10 in
wave blue, smooth

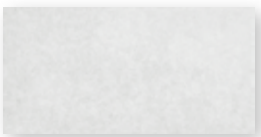

Wall tile 12.5 x 25 cm, 5 x 10 in
cliff white, smooth



Wall tile 12.5 x 25 cm, 5 x 10 in
atlantic blue, smooth

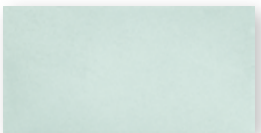

Wall tile 12.5 x 25 cm, 5 x 10 in
crystal green, smooth



Wall tile 12.5 x 25 cm, 5 x 10 in
pacific blue, smooth



Wall tile 12.5 x 25 cm, 5 x 10 in
island green, smooth



Wall tile 12.5 x 25 cm, 5 x 10 in
moos green, smooth



R10/B



Mosaic 2.5 x 2.5 cm, 1 x 1 in



Mosaic sheet 30 x 30 cm, 12 x 12 in seaside beige, structured,
Mosaic sheet 30 x 30 cm, 12 x 12 in seaside beige, structured, R10/B

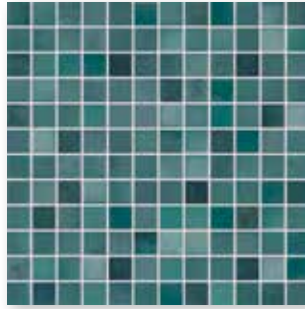

Mosaic sheet 30 x 30 cm, 12 x 12 in caribic blue, structured,
Mosaic sheet 30 x 30 cm, 12 x 12 in caribic blue, structured, R10/B



Mosaic sheet 30 x 30 cm, 12 x 12 in ocean green, structured,
Mosaic sheet 30 x 30 cm, 12 x 12 in ocean green, structured, R10/B



Mosaic sheet 30 x 30 cm, 12 x 12 in deep sea blue, structured,
Mosaic sheet 30 x 30 cm, 12 x 12 in deep sea blue, structured, R10/B



Mosaics glued thermoplastically on back of Agrob Buchtal can be used not only in dry zones but also without any problems in underwater areas (e.g. swimming pools/whirlpools) as well as in permanently wet areas (e.g. pool surrounds/showers).

Mosaic - joint 3 mm¹

Wall Tiles - joint 6 mm

2.5 x 2.5 cm

2.5 x 2.5 cm

6.2 x 25 cm²

12.5 x 25 cm

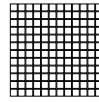
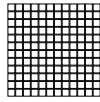

Sheet 297 x 297 cm

Sheet 297 x 297 cm



Nom. dim. - cm/in	2.5 x 2.5 / 1 x 1	2.5 x 2.5 / 1 x 1	6.2 x 25 / 2 1/2 x 10	12.5 x 25 / 5 x 10			
Work size	23 x 23 x 6.5 mm	23 x 23 x 6.5 mm	56 x 244 x 6 mm	119 x 244 x 6 mm			
Surface	structured, glossy	structured, matt	smooth, glossy	smooth, glossy			
m ² - pieces	11 sheets	11 sheets	64.000	32.000			
m ² - kg	12.100	12.100	10.880	12.160			
Bundle - pieces	11 sheets	11 sheets	88	44			
Bundle - m ²	1.000	1.000	1.375	1.375			
Bundle - kg	12.100	12.100	14.960	16.720			
Pallet - m ²	48.000	48.000	132.000	115.500			
Pallet - kg	580.800	580.800	1,436.160	1,404.480			
Product standard	Blb	Blb	Alb	Alb			
Slip resistance		R10/B					
Stress group	1	1					
seaside beige <input type="checkbox"/>	436220H Price gr. A250 (m ²)	436224H Price gr. A259 (m ²)					
ocean green <input type="checkbox"/>	436221H Price gr. A250 (m ²)	436225H Price gr. A259 (m ²)					
caribic blue <input type="checkbox"/>	436222H Price gr. A250 (m ²)	436226H Price gr. A259 (m ²)					
deep sea blue <input type="checkbox"/>	436223H Price gr. A250 (m ²)	436227H Price gr. A259 (m ²)					
sunset beige <input type="checkbox"/>			436228H Price gr. A175 (m ²)	436236H Price gr. A175 (m ²)			
cliff white <input type="checkbox"/>			436229H Price gr. A175 (m ²)	436237H Price gr. A175 (m ²)			
crystal green <input type="checkbox"/>			436230H Price gr. A175 (m ²)	436238H Price gr. A175 (m ²)			
island green <input type="checkbox"/>			436231H Price gr. A175 (m ²)	436239H Price gr. A175 (m ²)			
wave blue <input type="checkbox"/>			436232H Price gr. A175 (m ²)	436240H Price gr. A175 (m ²)			
atlantic blue <input type="checkbox"/>			436233H Price gr. A175 (m ²)	436241H Price gr. A175 (m ²)			
pacific blue <input type="checkbox"/>			436234H Price gr. A175 (m ²)	436242H Price gr. A175 (m ²)			
moos green <input type="checkbox"/>			436235H Price gr. A175 (m ²)	436243H Price gr. A175 (m ²)			



² Supplied as double-tiles; to be broken by customer.

The series Ocean will be available as of the 2nd quarter of 2025.

Rendering







With a breath of nostalgia

Experiencing original ideas anew, playfully combining motifs indoors and outdoors: with additional patterns and individual decorative elements, the “vintage modular system” of the series PATTERN provides an extensive range of products and perfectly fits into any living style. The Vanda decorative element offers a mix of 12 different floral and geometric motifs. The floral Isola decorative element and the geometric Baleno decorative element are ideal as individual motifs. Thanks to their delicate color compositions, each of the three decorative variants harmonizes with the basic tile in cement-grey. However, they can also be arranged to form larger motifs – or even a ceramic “carpet”.

Rendering / Architect: STELLWERK architekten, Dresden, Germany

Mosaic 2.5 x 2.5 cm, 1 x 1 in



Mosaic sheet Vola 30 x 30 cm, 12 x 12 in, multicolored, smooth



Mosaic sheet Vola 30 x 30 cm, 12 x 12 in, beige-brown, smooth

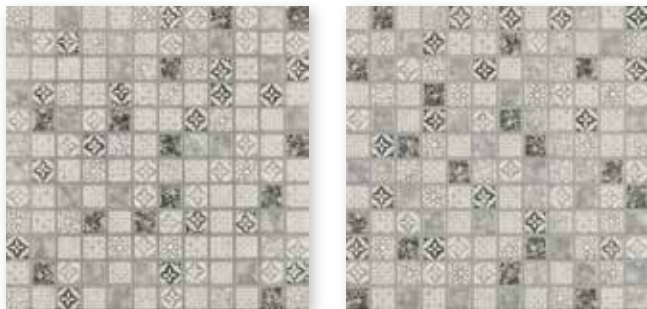

Mosaic sheet Vola 30 x 30 cm, 12 x 12 in, grey, smooth

Mosaic 5 x 5 cm, 2 x 2 in



Mosaic sheet Vola 30 x 30 cm, 12 x 12 in, multicolored, smooth, R10/B

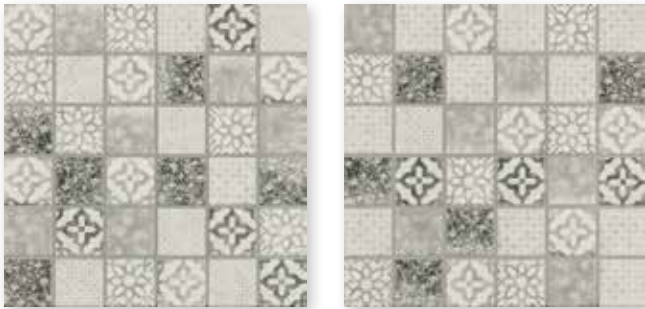

Mosaic sheet Vola 30 x 30 cm, 12 x 12 in, grey, smooth, R10/B



Mosaic sheet Ornamenta 30 x 30 cm, 12 x 12 in, blue, smooth



Mosaic sheet Ornamenta 30 x 30 cm, 12 x 12 in, multicolor, smooth

The Ornamenta decorations are color-coordinated with the decorative elements of the Trio series: Color and Lines (see page 472 and the following).



Mosaics glued thermoplastically on back of Agrob Buchtal can be used not only in dry zones but also without any problems in underwater areas (e.g. swimming pools/whirlpools) as well as in permanently wet areas.

The articles Vola, Mesh and Ornamenta each depict different motifs. Arrangement and packing are random and arbitrary.

Mosaic 10 x 10 cm, 4 x 4 in



Mosaic sheet Vola 30 x 30 cm, 12 x 12 in, multicolored, smooth



Mosaic sheet Mesh 30 x 30 cm, 12 x 12 in, natural-mix, smooth

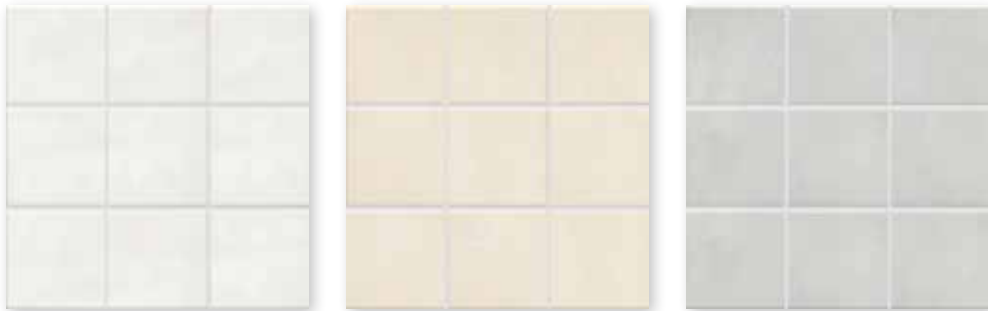

Mosaic sheet 30 x 30 cm, 12 x 12 in white, smooth

Mosaic sheet 30 x 30 cm, 12 x 12 in beige, smooth

Mosaic sheet 30 x 30 cm, 12 x 12 in grey, smooth



Mosaics glued thermoplastically on back of Agrob Buchtal can be used not only in dry zones but also without any problems in underwater areas (e.g. swimming pools/whirlpools) as well as in permanently wet areas.



Wall/floor tile Ornamenta 15 x 15 cm, 6 x 6 in, blue, smooth



Wall/floor tile Ornamenta 15 x 15 cm, 6 x 6 in, multicolor, smooth

The Ornamenta decorations are color-coordinated with the decorative elements of the Trio series: Color and Lines (see page 472 and the following).

The articles Vola, Mesh and Ornamenta each depict different motifs. Arrangement and packing are random and arbitrary.



Wall/floor tile Vola 20 x 20 cm, 8 x 8 in, multicolored, smooth



Wall/floor tile Vola 20 x 20 cm, 8 x 8 in, grey, smooth

The articles Vola and Salina each depict different motifs. Arrangement and packing are random and arbitrary.



Wall/floor tile Salina 20 x 20 cm, 8 x 8 in, multicolored, smooth



Individual motif Nelas
20 x 20 cm, 8 x 8 in,
black-white, smooth



Individual motif Mellby
20 x 20 cm, 8 x 8 in, grey,
smooth



Wall/floor tile
20 x 20 cm, 8 x 8 in,
white, smooth



Wall/floor tile
20 x 20 cm, 8 x 8 in,
beige, smooth



Wall/floor tile
20 x 20 cm, 8 x 8 in,
grey, smooth

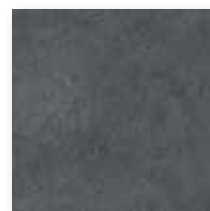

Wall/floor tile
20 x 20 cm, 8 x 8 in,
anthracite, smooth



Wall/floor tile
20 x 20 cm, 8 x 8 in,
cement grey, structured, R10/B



Wall/floor tile Vanda 20 x 20 cm, 8 x 8 in, multicolored, smooth, R10/B



Individual motif Baleno 20 x 20 cm, 8 x 8 in,
multicolored, smooth, R10/B

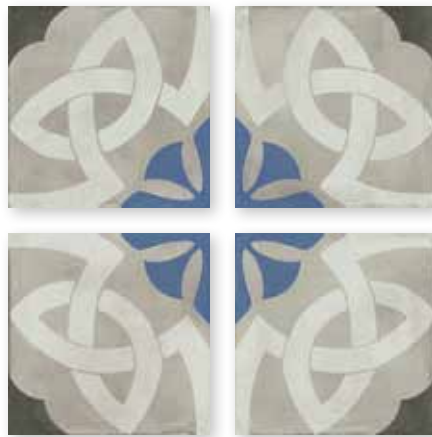

Individual motif Isola 20 x 20 cm, 8 x 8 in,
multicolored, smooth, R10/B

The articles Vanda each depict different motifs.
Arrangement and packing are random and arbitrary.

Mosaic

2.5 x 2.5 cm



Vola
Sheet: 297 x 297 mm

5 x 5 cm



Vola
Sheet: 297 x 297 mm

5 x 5 cmw



Ornamenta
Sheet: 297 x 297 mm

10 x 10 cm



Vola
Sheet: 297 x 297 mm

10 x 10 cm



Mesh
Sheet: 297 x 297 mm

10 x 10 cm



Sheet: 297 x 297 mm



	2.5 x 2.5 / 1 x 1	5 x 5 / 2 x 2	5 x 5 cm / 2 x 2	10 x 10 / 4 x 4	10 x 10 / 4 x 4	10 x 10 / 4 x 4	
	23 x 23 x 6.5 mm	47 x 47 x 6.5 mm	47 x 47 x 6.5 mm	97 x 97 x 6.5 mm	97 x 97 x 6.5 mm	97 x 97 x 6.5 mm	Nom. dim. - cm/in
	smooth, silky-matt	smooth, silky-matt	smooth, matt	smooth, silky-matt	smooth, silky-matt	smooth, silky-matt	Work size
	11 sheets	11 sheets	11.000	11 sheets	11 sheets	11 sheets	Surface
	12.100	12.331	12.331	13.101	13.101	13.101	m ² - pieces
	11 sheets	11 sheets	11 sheets	11 sheets	11 sheets	11 sheets	m ² - kg
	1.000	1.000	1.000	1.000	1.000	1.000	Bundle - pieces
	12.100	12.331	12.331	13.101	13.101	13.101	Bundle - m ²
	48.000	64.000	64.000	64.000	64.000	64.000	Bundle - kg
	580.800	789.184	789.184	838.464	838.464	838.464	Pallet - m ²
	B1b	B1b	B1b	B1b	B1b	B1b	Pallet - kg
		R10/B					Product standard
	1	1	1	1	1	1	Slip resistance
	42400H	42500H		42020H			Stress group
	Price gr. W303 (pce.)	Price gr. W171 (m ²)		Price gr. W150 (m ²)			4
	42401H						multicolored <input type="checkbox"/> V4
	Price gr. W303 (pce.)						3
	42402H	42501H					beige-brown <input type="checkbox"/> V4
	Price gr. W303 (pce.)	Price gr. W171 (m ²)					4
			42502H				grey <input type="checkbox"/> V4
			Price gr. W171 (m ²)				3
			42503H				blue <input type="checkbox"/> V2
			Price gr. W171 (m ²)				3
					42010H		Multicolor <input type="checkbox"/> V3
					Price gr. W150 (m ²)		4
						42000H	natural-mix <input type="checkbox"/> V4
						Price gr. W117 (m ²)	4
						42001H	white <input type="checkbox"/> V1
						Price gr. W117 (m ²)	4
						42002H	beige <input type="checkbox"/> V1
						Price gr. W117 (m ²)	4
							grey <input type="checkbox"/> V1

The articles Vola, Mesh and Ornamenta each depict different motifs.
Arrangement and packing are random and arbitrary.

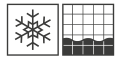

Wall and Floor Tiles

15 x 15 cm 20 x 20 cm 20 x 20 cm 20 x 20 cm 20 x 20 cm 20 x 20 cm 20 x 20 cm



	<i>Ornamenta</i>	<i>Vola</i>	<i>Salina</i>	<i>Individual motif Nelas</i>	<i>Individual motif Mellby</i>
Nom. dim. - cm/in	15 x 15 / 6 x 6	20 x 20 / 8 x 8	20 x 20 / 8 x 8	20 x 20 / 8 x 8	20 x 20 / 8 x 8
Work size	147 x 147 x 6.5 mm	197 x 197 x 6.5 mm	197 x 197 x 6.5 mm	197 x 197 x 6.5 mm	197 x 197 x 6.5 mm
Surface	smooth, matt	smooth, silky-matt	structured, matt	smooth, silky-matt	smooth, silky-matt
m ² - pieces	44.444	25	25	25	25
m ² - kg	13.955	13.875	13.875	13.875	13.875
Bundle - pieces	44	25	25	25	25
Bundle - m ²	0.990	1.000	1.000	1.000	1.000
Bundle - kg	13.816	13.875	13.875	13.875	13.875
Pallet - m ²	79.201	72.000	72.000	72.000	72.000
Pallet - kg	1,105.280	999.000	999.000	999.000	999.000
Product standard	Bib	Bib	Bla	Bib	Bib
Slip resistance			R10/B		
Stress group	1	1	1	1	1
white <input type="checkbox"/> V1	4	42100H Price gr. W117 (m ²)			
beige <input type="checkbox"/> V1	4	42101H Price gr. W117 (m ²)			
grey <input type="checkbox"/> V1	4	42102H Price gr. W117 (m ²)			
anthracite <input type="checkbox"/> V1	3	42103H Price gr. W117 (m ²)			
cement grey <input type="checkbox"/> V4			44425H Price gr. W117 (m ²)		
multicolored <input type="checkbox"/> V4	4		42120H Price gr. W150 (m ²)	42130H Price gr. W150 (m ²)	
black-white <input type="checkbox"/> V4	4				44400H Price gr. W150 (m ²)
grey <input type="checkbox"/> V4	4		42121H Price gr. W150 (m ²)		44401H Price gr. W150 (m ²)
blue <input type="checkbox"/> V3	3	44500H Price gr. W111 (m ²)			
multicolor <input type="checkbox"/> V4	3	44501H Price gr. W111 (m ²)			



The articles Vola, Mesh and Ornamenta each depict different motifs. Arrangement and packing are random and arbitrary.

Wall and Floor Tiles

20 x 20 cm 20 x 20 cm 20 x 20 cm



	<i>Individual motif Baleno</i>	<i>Individual motif Isola</i>	<i>Vanda</i>
Nom. dim. - cm/in	20 x 20 / 8 x 8	20 x 20 / 8 x 8	20 x 20 / 8 x 8
Work size	197 x 197 x 6.5 mm	197 x 197 x 6.5 mm	197 x 197 x 6.5 mm
Surface	structured, matt	structured, matt	structured, matt
m ² - pieces	25	25	25
m ² - kg	13.875	13.875	13.875
Bundle - pieces	25	25	25
Bundle - m ²	1.000	1.000	1.000
Bundle - kg	13.875	13.875	13.875
Pallet - m ²	72.000	72.000	72.000
Pallet - kg	999.000	999.000	999.000
Product standard	Bla	Bla	Bla
Slip resistance	R10/B	R10/B	R10/B
Stress group	1	1	1
multicolored <input type="checkbox"/> V4	44447H Price gr. W150 (m ²)	44448H Price gr. W150 (m ²)	44449H Price gr. W150 (m ²)



The article Vanda each depict different motifs. Arrangement and packing are random and arbitrary.

Rendering







A quotation from nature

For lovers of a natural look: the strikingly structured surface of the Pizarro series is reminiscent of slate – in a ceramic interpretation. The wall tiles in plain white and delicate grey are a perfect wall cladding for timeless bathrooms in a reduced ambience. For a rhythmic or accentuated look of the wall surface, elegant borders with metallic inlays are available.

Rendering

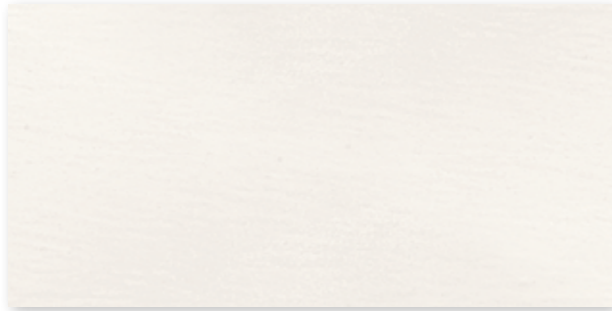

Wall tile 30 x 60 cm, 12 x 24 in, white, structured



Wall tile 30 x 60 cm, 12 x 24 in, grey, structured

Decoration elements

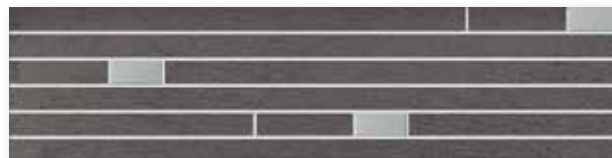

Border 15 x 60 cm, 6 x 24 in, anthracite, structured



Border 15 x 60 cm, 6 x 24 in, black, structured

Border: Glass fibre net on reverse side,
Sheet: 147 x 597 mm

Wall Tile³

Decoration Element^{1/2/4/5}

30 x 60 cm



15 x 60 cm



Border
Sheet: 147 x 597 mm

					30 x 60 / 12 x 24	15 x 60 / 6 x 24	Nom. dim. - cm/in
					297 x 597 x 9 mm	147 x 597 x 10.5 mm	Work size
					structured, silky-matt	structured, matt	Surface
					5.556/m ²	1.667/m	m ² /m - pieces
					14.946/m ²	3.584/m	m ² /m - kg
					9	1	Bundle - pieces
					1.620 m ²	0.600 m	Bundle - m ² /m
					24.210	2.150	Bundle - kg
					77.754		Pallet - m ²
					1,162.080		Pallet - kg
					BIII	Bla	Product standard
					281476		white <input type="checkbox"/> V1
					Price gr. C89 (m ²)		grey <input type="checkbox"/> V1
					281477		anthracite <input type="checkbox"/> V2
					Price gr. C89 (m ²)		black <input type="checkbox"/> V1
						281479	
						Price gr. C502 (pce.)	
						281480	
						Price gr. C502 (pce.)	



³ not frost-proof
⁴ Decoration elements only available in full boxes.
⁵ Only suitable for laying on the wall.



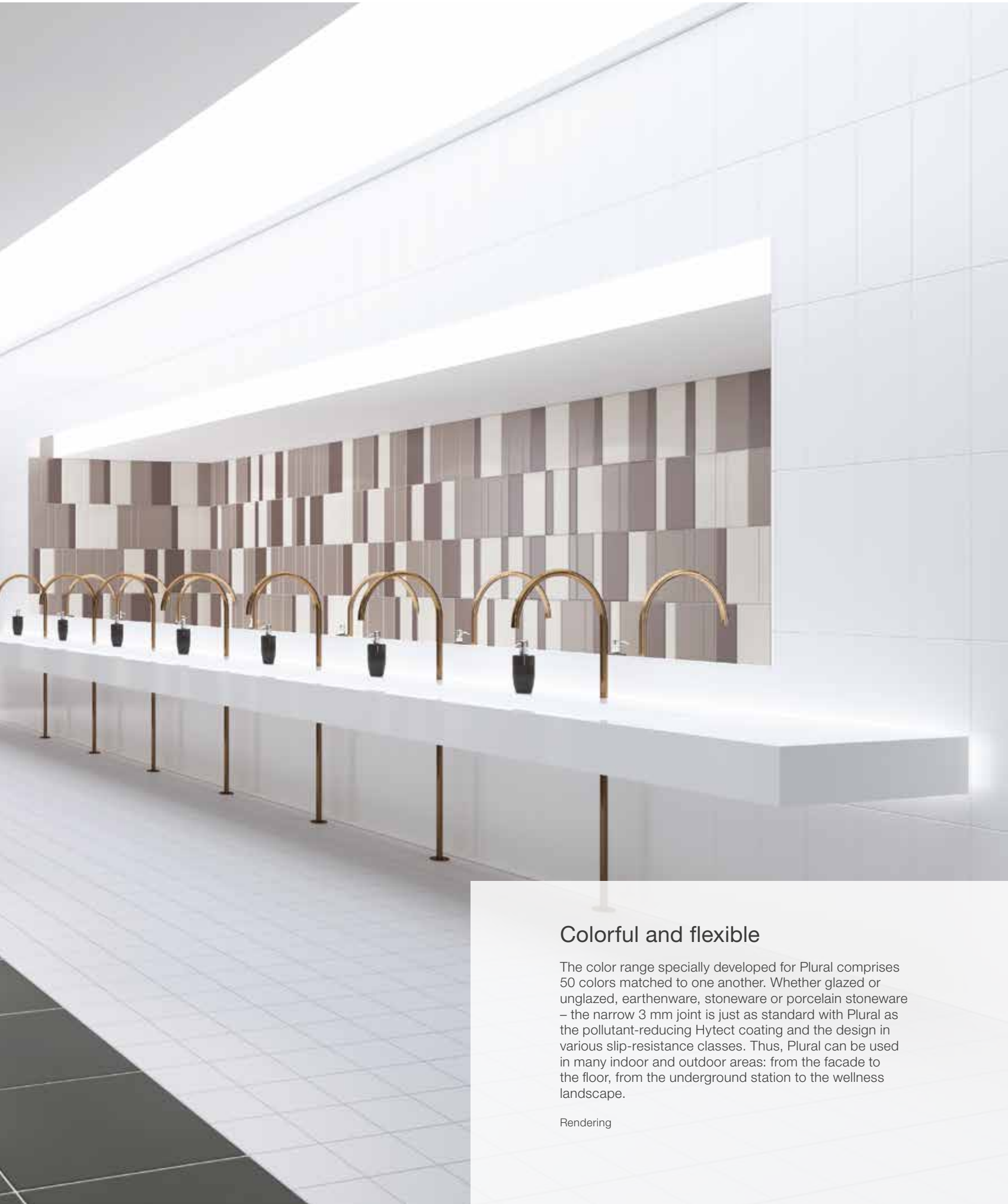

Colorful and flexible

The color range specially developed for Plural comprises 50 colors matched to one another. Whether glazed or unglazed, earthenware, stoneware or porcelain stoneware – the narrow 3 mm joint is just as standard with Plural as the pollutant-reducing Hytect coating and the design in various slip-resistance classes. Thus, Plural can be used in many indoor and outdoor areas: from the facade to the floor, from the underground station to the wellness landscape.

Rendering

Color System UNICOLOR – A color sphere becomes a sphere of possibilities



Intense colors



active ochre NCS S 3050-Y40R	active salmon NCS S 4040-Y70R	active oxid red NCS S 4050-Y90R	active stone grey NCS S 5030-Y90R	active sand grey NCS S 7010-Y90R
light ochre NCS S 2030-Y20R	light salmon NCS S 1515-Y50R	light oxid red NCS S 2010-Y80R	light stone grey NCS S 2502-R	light sand grey NCS S 1502-Y
medium ochre NCS S 3030-Y30R	medium salmon NCS S 2020-Y50R	medium oxid red NCS S 3020-Y80R	medium stone grey NCS S 3502-R or RAL 7036	medium sand grey NCS S 3005-Y50R
dark ochre NCS S 4030-Y50R	dark salmon NCS S 3040-Y60R	dark oxid red NCS S 5020-Y80R	dark stone grey NCS S 6005-Y80R	dark sand grey NCS S 6010-Y50R
ochre		salmon		oxid red
			stone grey	sand-grey
neutral 5 (basalt-grey) NCS S 5502-B or RAL 7046	neutral 4 (graphite-black) NCS S 6000-N or RAL 7037	neutral 3 (asphalt black) NCS S 6500-N	neutral 2 (anthracite) NCS S 7500-N or RAL 7015	neutral 1 (deep black) NCS S 9000-N or RAL 9017



sea green
NCS S4030-G
or RAL design
6000



blue green
NCS S3040-B50G
or RAL design
190 50 25



cobalt blue
NCS S4055-R70B
or RAL design
290 30 40

Intense colors

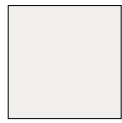

1120/1121
neutral 10 (active white)

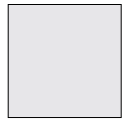

1119
neutral 9 (white-grey)



1118
neutral 8 (light-grey)



1117
neutral 7 (pebble-grey)



1115
neutral 5 (basalt-grey)



1113
neutral 3 (asphalt black)



1112
neutral 2 (anthracite)



1111
neutral 1 (deep black)



1004
dark azure



1003
medium azure



1002
light azure



1008
dark blue



1007
medium blue



1006
light blue



1012
dark turquoise



1011
medium turquoise



1010
light turquoise



1016
dark green



1015
medium green

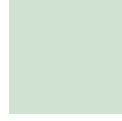

1014
light green



1020
dark yellow



1019
medium yellow

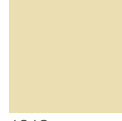

1018
light yellow



1024
dark ochre



1023
medium ochre



1022
light ochre



1028
dark salmon



1027
medium salmon



1026
light salmon



1032
dark oxid red



1031
medium oxid red

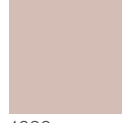

1030
light oxid red



1036
dark stone grey



1035
medium stone grey



1034
light stone grey



1040
dark sand grey



1039
medium sand grey

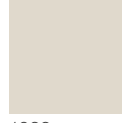

1038
light sand grey



1001
active azure



1005
active blue



1009
active turquoise



1013
active green



1017
active yellow

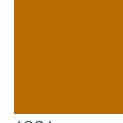

1021
active ochre



1025
active salmon



1029
active oxid red



1033
active stone grey



1037
active sand grey



1050
cobalt blue



1049
blue green



1048
sea green



1047
yellow green



1046
sunshine yellow

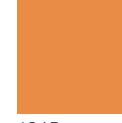

1045
signal orange



1044
fire red



1043
brown red

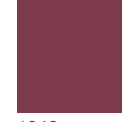

1042
berry red

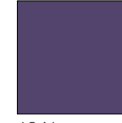

1041
violet

Formats – Earthenware



Wall tile 15 x 30 cm
6 x 12 in, smooth



Wall tile 20 x 40 cm
8 x 16 in, smooth

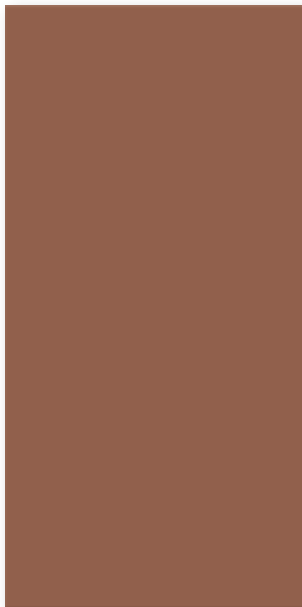

Wall tile 30 x 60 cm,
12 x 24 in, smooth

Wall Tiles³

15 x 30 cm²



20 x 40 cm²

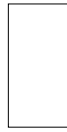

30 x 60 cm



Nom. dim. - cm/in	15 x 30 / 6 x 12	20 x 40 / 8 x 16	30 x 60 / 12 x 24				
Work size	147 x 297 x 6.5 mm	197 x 397 x 7.5 mm	297 x 597 x 9 mm				
Surface	smooth, silky-matt	smooth, silky-matt	smooth, silky-matt				
m ² - pieces	22.222	12.500	5.556				
m ² - kg	10.622	12.975	14.946				
Bundle - pieces	24	16	9				
Bundle - m ²	1.080	1.280	1.620				
Bundle - kg	11.472	16.608	24.210				
Pallet - m ²	91.801	92.160	77.754				
Pallet - kg	975.120	1,195.776	1,162.080				
Product standard	BIII	BIII	BIII				
neutral 10	130-1121H	240-1121H	360-1121H				
(active white gl.) <input type="checkbox"/>	Price gr. A100 (m ²)	Price gr. A100 (m ²)	Price gr. A88 (m ²)				
neutral 10	130-1120H	240-1120H	360-1120H				
(active white) <input type="checkbox"/>	Price gr. A100 (m ²)	Price gr. A100 (m ²)	Price gr. A88 (m ²)				
neutral 9	130-1119H	240-1119H	360-1119H				
(white grey) <input type="checkbox"/>	Price gr. A121 (m ²)	Price gr. A121 (m ²)	Price gr. A109 (m ²)				
neutral 8	130-1118H¹	240-1118H¹	360-1118H				
(light-grey) <input type="checkbox"/>	Price gr. A148 (m ²)	Price gr. A148 (m ²)	Price gr. A109 (m ²)				
neutral 7	130-1117H	240-1117H	360-1117H				
(pebble-grey) <input type="checkbox"/>	Price gr. A121 (m ²)	Price gr. A121 (m ²)	Price gr. A109 (m ²)				
neutral 5	130-1115H	240-1115H	360-1115H				
(basalt grey) <input type="checkbox"/>	Price gr. A121 (m ²)	Price gr. A121 (m ²)	Price gr. A109 (m ²)				
neutral 3	130-1113H	240-1113H	360-1113H				
(asphalt black) <input type="checkbox"/>	Price gr. A121 (m ²)	Price gr. A121 (m ²)	Price gr. A109 (m ²)				
neutral 2	130-1112H¹	240-1112H¹	360-1112H¹				
(anthracite) <input type="checkbox"/>	Price gr. A121 (m ²)	Price gr. A148 (m ²)	Price gr. A136 (m ²)				
neutral 1	130-1111H	240-1111H	360-1111H				
(deep black) <input type="checkbox"/>	Price gr. A121 (m ²)	Price gr. A121 (m ²)	Price gr. A109 (m ²)				
active azure	130-1001H¹	240-1001H¹	360-1001H¹				
<input type="checkbox"/>	Price gr. A148 (m ²)	Price gr. A148 (m ²)	Price gr. A136 (m ²)				
light azure	130-1002H¹	240-1002H	360-1002H¹				
<input type="checkbox"/>	Price gr. A148 (m ²)	Price gr. A121 (m ²)	Price gr. A136 (m ²)				
medium azure	130-1003H¹	240-1003H¹	360-1003H¹				
<input type="checkbox"/>	Price gr. A148 (m ²)	Price gr. A148 (m ²)	Price gr. A136 (m ²)				
dark azure	130-1004H	240-1004H	360-1004H				
<input type="checkbox"/>	Price gr. A121 (m ²)	Price gr. A121 (m ²)	Price gr. A109 (m ²)				
active blue	130-1005H¹	240-1005H¹	360-1005H¹				
<input type="checkbox"/>	Price gr. A148 (m ²)	Price gr. A148 (m ²)	Price gr. A136 (m ²)				
light blue	130-1006H¹	240-1006H	360-1006H¹				
<input type="checkbox"/>	Price gr. A148 (m ²)	Price gr. A121 (m ²)	Price gr. A136 (m ²)				
medium blue	130-1007H¹	240-1007H¹	360-1007H¹				
<input type="checkbox"/>	Price gr. A148 (m ²)	Price gr. A148 (m ²)	Price gr. A136 (m ²)				
dark blue	130-1008H	240-1008H	360-1008H				
<input type="checkbox"/>	Price gr. A121 (m ²)	Price gr. A121 (m ²)	Price gr. A109 (m ²)				
active turquoise	130-1009H¹	240-1009H¹	360-1009H¹				
<input type="checkbox"/>	Price gr. A148 (m ²)	Price gr. A148 (m ²)	Price gr. A136 (m ²)				
light turquoise	130-1010H¹	240-1010H	360-1010H¹				
<input type="checkbox"/>	Price gr. A148 (m ²)	Price gr. A121 (m ²)	Price gr. A136 (m ²)				
medium turquoise	130-1011H¹	240-1011H¹	360-1011H¹				
<input type="checkbox"/>	Price gr. A148 (m ²)	Price gr. A148 (m ²)	Price gr. A136 (m ²)				
dark turquoise	130-1012H	240-1012H	360-1012H				
<input type="checkbox"/>	Price gr. A121 (m ²)	Price gr. A121 (m ²)	Price gr. A109 (m ²)				
active green	130-1013H¹	240-1013H¹	360-1013H¹				
<input type="checkbox"/>	Price gr. A148 (m ²)	Price gr. A148 (m ²)	Price gr. A136 (m ²)				
light green	130-1014H¹	240-1014H	360-1014H¹				
<input type="checkbox"/>	Price gr. A148 (m ²)	Price gr. A121 (m ²)	Price gr. A136 (m ²)				
medium green	130-1015H¹	240-1015H¹	360-1015H¹				
<input type="checkbox"/>	Price gr. A148 (m ²)	Price gr. A148 (m ²)	Price gr. A136 (m ²)				
dark green	130-1016H	240-1016H	360-1016H				
<input type="checkbox"/>	Price gr. A121 (m ²)	Price gr. A121 (m ²)	Price gr. A109 (m ²)				



² One overglazed head edge 10% per delivery. Edges overglazed 2/3 each.

³ Suitability for operating theatres on request.

Wall Tiles³

15 x 30 cm²



20 x 40 cm²



30 x 60 cm



	15 x 30 / 6 x 12	20 x 40 / 8 x 16	30 x 60 / 12 x 24	Nom. dim. - cm/in
	147 x 297 x 6.5 mm	197 x 397 x 7.5 mm	297 x 597 x 9 mm	Work size
	smooth, silky-matt	smooth, silky-matt	smooth, silky-matt	Surface
	22.222	12.500	5.556	m ² - pieces
	10.622	12.975	14.946	m ² - kg
	24	16	9	Bundle - pieces
	1.080	1.280	1.620	Bundle - m ²
	11.472	16.608	24.210	Bundle - kg
	91.801	92.160	77.754	Pallet - m ²
	975.120	1,195.776	1,162.080	Pallet - kg
	BIII	BIII	BIII	Product standard
	130-1017H ¹	240-1017H ¹	360-1017H ¹	
	Price gr. A148 (m ²)	Price gr. A148 (m ²)	Price gr. A136 (m ²)	active yellow <input type="checkbox"/>
	130-1018H ¹	240-1018H	360-1018H ¹	
	Price gr. A148 (m ²)	Price gr. A121 (m ²)	Price gr. A136 (m ²)	light yellow <input type="checkbox"/>
	130-1019H ¹	240-1019H ¹	360-1019H ¹	
	Price gr. A148 (m ²)	Price gr. A148 (m ²)	Price gr. A136 (m ²)	medium yellow <input type="checkbox"/>
	130-1020H	240-1020H	360-1020H	
	Price gr. A121 (m ²)	Price gr. A121 (m ²)	Price gr. A109 (m ²)	dark yellow <input type="checkbox"/>
	130-1021H ¹	240-1021H ¹	360-1021H ¹	
	Price gr. A148 (m ²)	Price gr. A148 (m ²)	Price gr. A136 (m ²)	active ochre <input type="checkbox"/>
	130-1022H ¹	240-1022H	360-1022H ¹	
	Price gr. A148 (m ²)	Price gr. A121 (m ²)	Price gr. A136 (m ²)	light ochre <input type="checkbox"/>
	130-1023H ¹	240-1023H ¹	360-1023H ¹	
	Price gr. A148 (m ²)	Price gr. A148 (m ²)	Price gr. A136 (m ²)	medium ochre <input type="checkbox"/>
	130-1024H	240-1024H	360-1024H	
	Price gr. A121 (m ²)	Price gr. A121 (m ²)	Price gr. A109 (m ²)	dark ochre <input type="checkbox"/>
	130-1025H ¹	240-1025H ¹	360-1025H ¹	
	Price gr. A148 (m ²)	Price gr. A148 (m ²)	Price gr. A136 (m ²)	active salmon <input type="checkbox"/>
	130-1026H ¹	240-1026H	360-1026H ¹	
	Price gr. A148 (m ²)	Price gr. A121 (m ²)	Price gr. A136 (m ²)	light salmon <input type="checkbox"/>
	130-1027H ¹	240-1027H ¹	360-1027H ¹	
	Price gr. A148 (m ²)	Price gr. A148 (m ²)	Price gr. A136 (m ²)	medium salmon <input type="checkbox"/>
	130-1028H	240-1028H	360-1028H	
	Price gr. A121 (m ²)	Price gr. A121 (m ²)	Price gr. A109 (m ²)	dark salmon <input type="checkbox"/>
	130-1029H ¹	240-1029H ¹	360-1029H ¹	
	Price gr. A148 (m ²)	Price gr. A148 (m ²)	Price gr. A136 (m ²)	active oxide red <input type="checkbox"/>
	130-1030H ¹	240-1030H	360-1030H ¹	
	Price gr. A148 (m ²)	Price gr. A121 (m ²)	Price gr. A136 (m ²)	light oxide red <input type="checkbox"/>
	130-1031H ¹	240-1031H ¹	360-1031H ¹	
	Price gr. A148 (m ²)	Price gr. A148 (m ²)	Price gr. A136 (m ²)	medium oxide red <input type="checkbox"/>
	130-1032H	240-1032H	360-1032H	
	Price gr. A121 (m ²)	Price gr. A121 (m ²)	Price gr. A109 (m ²)	dark oxide red <input type="checkbox"/>
	130-1033H ¹	240-1033H ¹	360-1033H ¹	
	Price gr. A148 (m ²)	Price gr. A148 (m ²)	Price gr. A136 (m ²)	active stone grey <input type="checkbox"/>
	130-1034H ¹	240-1034H	360-1034H ¹	
	Price gr. A148 (m ²)	Price gr. A121 (m ²)	Price gr. A136 (m ²)	light stone grey <input type="checkbox"/>
	130-1035H ¹	240-1035H ¹	360-1035H ¹	
	Price gr. A148 (m ²)	Price gr. A148 (m ²)	Price gr. A136 (m ²)	medium stone grey <input type="checkbox"/>
	130-1036H	240-1036H	360-1036H	
	Price gr. A121 (m ²)	Price gr. A121 (m ²)	Price gr. A109 (m ²)	dark stone grey <input type="checkbox"/>
	130-1037H ¹	240-1037H ¹	360-1037H ¹	
	Price gr. A148 (m ²)	Price gr. A148 (m ²)	Price gr. A136 (m ²)	active sand-grey <input type="checkbox"/>
	130-1038H	240-1038H	360-1038H	
	Price gr. A121 (m ²)	Price gr. A121 (m ²)	Price gr. A109 (m ²)	light sand-grey <input type="checkbox"/>
	130-1039H	240-1039H ¹	360-1039H ¹	
	Price gr. A121 (m ²)	Price gr. A148 (m ²)	Price gr. A136 (m ²)	medium sand-grey <input type="checkbox"/>
	130-1040H	240-1040H	360-1040H	
	Price gr. A121 (m ²)	Price gr. A121 (m ²)	Price gr. A109 (m ²)	dark sand-grey <input type="checkbox"/>



² One overglazed head edge 10% per delivery. Edges overglazed 2/3 each.

³ Suitability for operating theatres on request.

346 Plural earthenware

Dry-pressed Ceramic Tiles, DIN EN 14411, group BIII, glazed (GL) for wall coverings in indoor areas (earthenware tiles)

Wall Tiles¹ **NEW**

15 x 30 cm



30 x 60 cm

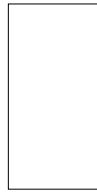

Nom. dim. - cm/in	15 x 30 / 6 x 12	30 x 60 / 12 x 24				
Work size	147 x 297 x 6.5 mm	297 x 597 x 9 mm				
Surface	smooth, silky-matt	smooth, silky-matt				
m ² - pieces	22.222	5.556				
m ² - kg	10.622	14.946				
Bundle - pieces	24	9				
Bundle - m ²	1.080	1.620				
Bundle - kg	11.472	24.210				
Pallet - m ²	91.801	77.754				
Pallet - kg	975.120	1,162.080				
Product standard	BIII	BIII				
violet <input type="checkbox"/>	<i>130-1041H</i> Price gr. A148 (m ²)	<i>360-1041H</i> Price gr. A148 (m ²)				
berry red <input type="checkbox"/>	<i>130-1042H</i> Price gr. A148 (m ²)	<i>360-1042H</i> Price gr. A148 (m ²)				
brown red <input type="checkbox"/>	<i>130-1043H</i> Price gr. A148 (m ²)	<i>360-1043H</i> Price gr. A148 (m ²)				
fire red <input type="checkbox"/>	<i>130-1044H</i> Price gr. A148 (m ²)	<i>360-1044H</i> Price gr. A148 (m ²)				
signal orange <input type="checkbox"/>	<i>130-1045H</i> Price gr. A148 (m ²)	<i>360-1045H</i> Price gr. A148 (m ²)				
sunshine yellow <input type="checkbox"/>	<i>130-1046H</i> Price gr. A148 (m ²)	<i>360-1046H</i> Price gr. A148 (m ²)				
yellow green <input type="checkbox"/>	<i>130-1047H</i> Price gr. A148 (m ²)	<i>360-1047H</i> Price gr. A148 (m ²)				
sea green <input type="checkbox"/>	<i>130-1048H</i> Price gr. A148 (m ²)	<i>360-1048H</i> Price gr. A148 (m ²)				
blue green <input type="checkbox"/>	<i>130-1049H</i> Price gr. A148 (m ²)	<i>360-1049H</i> Price gr. A148 (m ²)				
cobalt blue <input type="checkbox"/>	<i>130-1050H</i> Price gr. A148 (m ²)	<i>360-1050H</i> Price gr. A148 (m ²)				





Intense colors

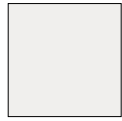

2120/2121/700/701
neutral 10 (active white)



2119/552119
neutral 9 (white-grey)



2118/552118
neutral 8 (light-grey)



2117/552117
neutral 7 (pebble-grey)



2116/552116
neutral 6 (pearl grey)



2115/552115
neutral 5 (basalt-grey)



2114/552114
neutral 4 (graphite-black)



2113/552113
neutral 3 (asphalt black)



2112/552112
neutral 2 (anthracite)



2111/5716
neutral 1 (deep black)



2004/552004
dark azure



2008/552008
dark blue



2012/552012
dark turquoise



2016/552016
dark green



2020/552020
dark yellow



2024/552024
dark ochre



2028/552028
dark salmon



2032/552032
dark oxid red



2036/552036
dark stone grey



2040/552040
dark sand grey



2003/552003
medium azure



2007/552007
medium blue



2011/552011
medium turquoise



2015/552015
medium green



2019/552019
medium yellow



2023/552023
medium ochre



2027/552027
medium salmon



2031/552031
medium oxid red



2035/552035
medium stone grey



2039/552039
medium sand grey



2002/552002
light azure



2006/552006
light blue



2010/552010
light turquoise

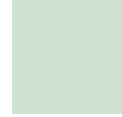

2014/552014
light green



2018/552018
light yellow



2022/552022
light ochre



2026/552026
light salmon



2030/552030
light oxid red



2034/552034
light stone grey



2038/552038
light sand grey



2001/552001
active azure



2005/552005
active blue



2009/552009
active turquoise



2013/552013
active green



2017/552017
active yellow



2021/552021
active ochre



2025/552025
active salmon



2029/552029
active oxid red



2033/552033
active stone grey



2037/552037
active sand grey



2050
cobalt-blue



2049
blue-green



2048
sea-green



2047
yellow-green



2046
sunshine-yellow



2045
signal-orange



2044
fire-red



2043
brown-red



2042
berry-red



2041
violet

Formats Stoneware

Mosaic 2.5 x 2.5 cm, 1 x 1 in

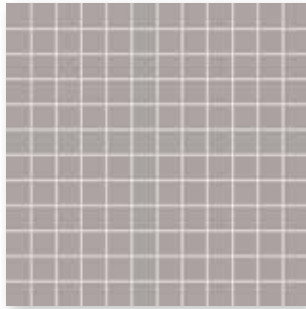

Mosaic sheet 30 x 30 cm, 12 x 12 in,
smooth



Floor/wall tile
10 x 20 cm, 4 x 8 in,
smooth



Floor/wall tile
12.5 x 50 cm, 5 x 20 in,
smooth

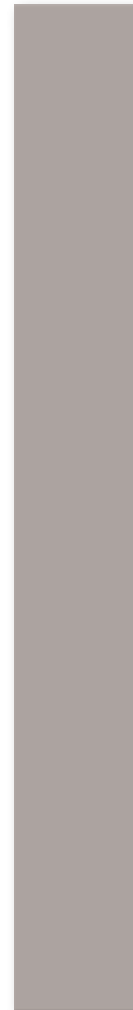

Floor/wall tile
12.5 x 100 cm, 5 x 40 in,
smooth

Mosaic 5 x 5 cm, 2 x 2 in

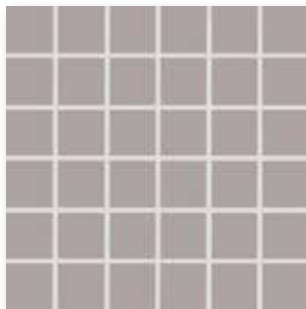

Mosaic sheet 30 x 30 cm, 12 x 12 in,
smooth

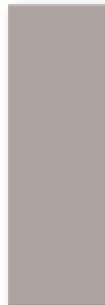

Floor/wall tile
10 x 30 cm, 4 x 12 in,
smooth

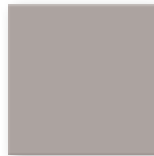

Floor/wall tile
15 x 15 cm, 6 x 6 in,
smooth

Mosaic 10 x 10 cm, 4 x 4 in

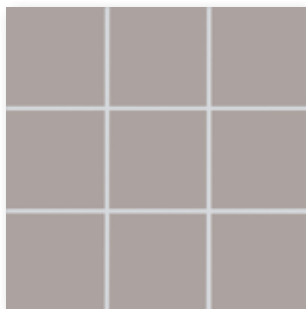

Mosaic sheet 30 x 30 cm, 12 x 12 in,
smooth

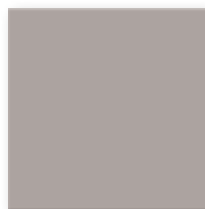

Floor/wall tile
20 x 20 cm, 8 x 8 in,
smooth



Mosaics glued thermoplastically on back of Agrob Buchtal can be used not only in dry zones but also without any problems in underwater areas (e.g. swimming pools/whirlpools) as well as in permanently wet areas.

Do you already know our Mosaic Designer at our website www.agrob-buchtal.com? There, you will have the possibility of designing your individual color gradients, mosaic compositions and the laying of pictures.

350 Plural
stoneware



Floor/wall tile
25 x 50 cm, 10 x 20 in,
smooth



Floor/wall tile 30 x 30 cm, 12 x 12 in,
smooth

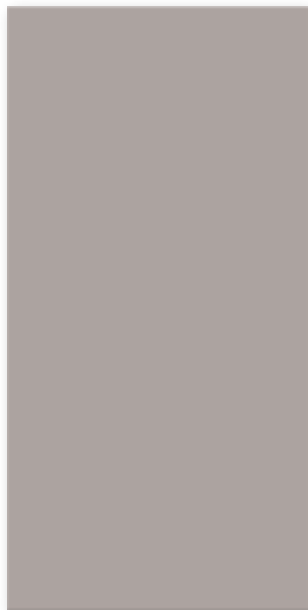

Floor/wall tile 30 x 60 cm, 12 x 24 in,
smooth

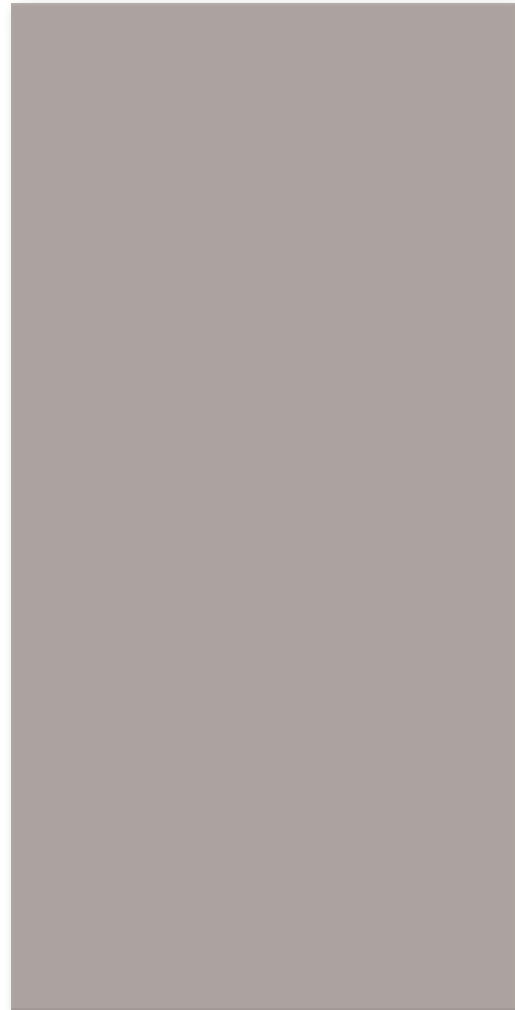

Floor/wall tile 50 x 100 cm, 20 x 40 in, smooth



Cove skirting
10 x 10 cm
4 x 4 in, smooth



Internal
corner,
smooth



External
corner,
smooth

Mosaic

2.5 x 2.5 cm^{3/5}

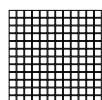

Sheet: 297 x 297 mm

5 x 5 cm^{3/5}

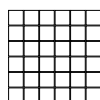

Sheet: 297 x 297 mm

10 x 10 cm^{3/5/7}

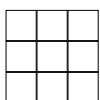

Sheet: 297 x 297 mm

Floor/Wall Tiles

10 x 20 cm **NEW**



10 x 30 cm



12.5 x 50 cm²



12.5 x 100 cm²



2.5 x 2.5 / 1 x 1	5 x 5 / 2 x 2	10 x 10 / 4 x 4	10 x 20 / 4 x 8	10 x 30 / 4 x 12	12.5 x 50 / 5 x 20	12.5 x 100 / 5 x 40	Model number
23 x 23 x 6.5 mm smooth, for op-theat.	47 x 47 x 6.5 mm smooth, for op-theat.	97 x 97 x 6.5 mm smooth, for op-theat.	97 x 197 x 6.5 mm smooth, for op-theat.	97 x 297 x 6 mm smooth, silky-matt ⁶	122 x 497 x 8 mm smooth, silky-matt ⁶	122 x 997 x 8 mm smooth, silky-matt ⁶	Nom. dim. - cm/in
11 sheets	11 sheets	11 sheets	50.000	33.333	16.000	8.000	Work size
12.100	12.331	13.101	13.600	12.333	17.040	17.040	Surface
11 sheets	11 sheets	11 sheets	33	38	8	10	m ² - pieces
1.000	1.000	1.000	0.660	1.140	0.500	1.250	m ² - kg
12.100	12.331	13.101	8.976	14.060	8.520	21.300	Bundle - pieces
48.000	64.000	64.000	59.400	95.761	55.000	67.500	Bundle - m ²
580.800	789.184	838.464	807.840	1,181.040	937.200	1,150.200	Bundle - kg
Bib	Bib	Bib	Bib	Alb	Alb	Alb	Pallet - m ²
1	1	1	1	1	1	1	Pallet - kg
	705-2121H	710-2121H	712-2121H	703-2121H	700i-341550HK	700i-352010HK	Product standard
	Price gr. A187 (m ²)	Price gr. A142 (m ²)	Price gr. A157 (m ²)	Price gr. A142 (m ²)	Price gr. A211 (m ²)	Price gr. A265 (m ²)	Stress group
702-2120H	705-2120H	710-2120H	712-2120H	703-2120H	701i-341550HK	701i-352010HK	4 (active white gl.) <input type="checkbox"/>
Price gr. A229 (m ²)	Price gr. A187 (m ²)	Price gr. A142 (m ²)	Price gr. A157 (m ²)	Price gr. A142 (m ²)	Price gr. A211 (m ²)	Price gr. A265 (m ²)	4 neutral 10 <input type="checkbox"/>
702-2119H¹	705-2119H	710-2119H	712-2119H	703-2119H¹	552119-341550HK¹	552119-352010HK¹	4 (active white) <input type="checkbox"/>
Price gr. A280 (m ²)	Price gr. A211 (m ²)	Price gr. A157 (m ²)	Price gr. A178 (m ²)	Price gr. A187 (m ²)	Price gr. A259 (m ²)	Price gr. A313 (m ²)	4 neutral 9 <input type="checkbox"/>
702-2118H	705-2118H	710-2118H	712-2118H¹	703-2118H	552118-341550HK	552118-352010HK	4 (white grey) <input type="checkbox"/>
Price gr. A229 (m ²)	Price gr. A187 (m ²)	Price gr. A142 (m ²)	Price gr. A211 (m ²)	Price gr. A142 (m ²)	Price gr. A211 (m ²)	Price gr. A265 (m ²)	4 neutral 8 <input type="checkbox"/>
702-2117H¹	705-2117H	710-2117H	712-2117H	703-2117H¹	552117-341550HK	552117-352010HK	4 (light-grey) <input type="checkbox"/>
Price gr. A280 (m ²)	Price gr. A211 (m ²)	Price gr. A157 (m ²)	Price gr. A178 (m ²)	Price gr. A187 (m ²)	Price gr. A229 (m ²)	Price gr. A289 (m ²)	4 neutral 7 <input type="checkbox"/>
702-2116H¹	705-2116H	710-2116H¹	712-2116H¹				3 neutral 7 <input type="checkbox"/>
Price gr. A280 (m ²)	Price gr. A238 (m ²)	Price gr. A187 (m ²)	Price gr. A211 (m ²)				3 neutral 6 <input type="checkbox"/>
702-2115H¹	705-2115H	710-2115H	712-2115H	703-2115H¹	552115-341550HK¹	552115-352010HK¹	3 neutral 5 <input type="checkbox"/>
Price gr. A280 (m ²)	Price gr. A211 (m ²)	Price gr. A157 (m ²)	Price gr. A178 (m ²)	Price gr. A187 (m ²)	Price gr. A259 (m ²)	Price gr. A313 (m ²)	3 neutral 4 <input type="checkbox"/>
702-2114H¹	705-2114H	710-2114H	712-2114H¹				3 neutral 4 <input type="checkbox"/>
Price gr. A280 (m ²)	Price gr. A211 (m ²)	Price gr. A157 (m ²)	Price gr. A211 (m ²)				3 (graphite black) <input type="checkbox"/>
702-2113H¹	705-2113H	710-2113H	712-2113H	703-2113H	552113-341550HK	552113-352010HK	3 neutral 3 <input type="checkbox"/>
Price gr. A280 (m ²)	Price gr. A211 (m ²)	Price gr. A157 (m ²)	Price gr. A178 (m ²)	Price gr. A157 (m ²)	Price gr. A229 (m ²)	Price gr. A289 (m ²)	3 (asphalt black) <input type="checkbox"/>
702-2112H¹	705-2112H	710-2112H	712-2112H¹	703-2112H¹	552112-341550HK¹	552112-352010HK¹	2 neutral 2 <input type="checkbox"/>
Price gr. A280 (m ²)	Price gr. A211 (m ²)	Price gr. A157 (m ²)	Price gr. A211 (m ²)	Price gr. A187 (m ²)	Price gr. A259 (m ²)	Price gr. A313 (m ²)	2 (anthracite) <input type="checkbox"/>
702-2111H	705-2111H	710-2111H	712-2111H	703-2111H⁴	5716-341550HK^{1/4}	5716-352010HK^{1/4}	1 neutral 1 <input type="checkbox"/>
Price gr. A250 (m ²)	Price gr. A211 (m ²)	Price gr. A157 (m ²)	Price gr. A178 (m ²)	Price gr. A187 (m ²)	Price gr. A259 (m ²)	Price gr. A313 (m ²)	1 (deep black) <input type="checkbox"/>
	705-2001H	710-2001H	712-2001H¹	703-2001H	552001-341550HK	552001-352010HK	2 active azure <input type="checkbox"/>
	Price gr. A211 (m ²)	Price gr. A157 (m ²)	Price gr. A211 (m ²)	Price gr. A157 (m ²)	Price gr. A229 (m ²)	Price gr. A289 (m ²)	2 active azure <input type="checkbox"/>
702-2002H¹	705-2002H	710-2002H	712-2002H¹	703-2002H¹	552002-341550HK¹	552002-352010HK¹	4 light azure <input type="checkbox"/>
Price gr. A280 (m ²)	Price gr. A211 (m ²)	Price gr. A157 (m ²)	Price gr. A211 (m ²)	Price gr. A187 (m ²)	Price gr. A259 (m ²)	Price gr. A313 (m ²)	4 light azure <input type="checkbox"/>
702-2003H	705-2003H	710-2003H	712-2003H¹	703-2003H	552003-341550HK	552003-352010HK	3 medium azure <input type="checkbox"/>
Price gr. A250 (m ²)	Price gr. A211 (m ²)	Price gr. A157 (m ²)	Price gr. A211 (m ²)	Price gr. A157 (m ²)	Price gr. A229 (m ²)	Price gr. A289 (m ²)	3 medium azure <input type="checkbox"/>
702-2004H	705-2004H	710-2004H	712-2004H	703-2004H¹	552004-341550HK¹	552004-352010HK¹	2 dark azure <input type="checkbox"/>
Price gr. A250 (m ²)	Price gr. A211 (m ²)	Price gr. A157 (m ²)	Price gr. A178 (m ²)	Price gr. A187 (m ²)	Price gr. A259 (m ²)	Price gr. A313 (m ²)	2 dark azure <input type="checkbox"/>
	705-2005H	710-2005H	712-2005H¹	703-2005H¹	552005-341550HK¹	552005-352010HK¹	2 active blue <input type="checkbox"/>
	Price gr. A211 (m ²)	Price gr. A157 (m ²)	Price gr. A211 (m ²)	Price gr. A187 (m ²)	Price gr. A259 (m ²)	Price gr. A313 (m ²)	2 active blue <input type="checkbox"/>
702-2006H¹	705-2006H	710-2006H	712-2006H¹	703-2006H¹	552006-341550HK¹	552006-352010HK¹	4 light blue <input type="checkbox"/>
Price gr. A280 (m ²)	Price gr. A211 (m ²)	Price gr. A157 (m ²)	Price gr. A211 (m ²)	Price gr. A187 (m ²)	Price gr. A259 (m ²)	Price gr. A313 (m ²)	4 light blue <input type="checkbox"/>
702-2007H¹	705-2007H	710-2007H	712-2007H¹	703-2007H¹	552007-341550HK¹	552007-352010HK¹	3 medium blue <input type="checkbox"/>
Price gr. A280 (m ²)	Price gr. A211 (m ²)	Price gr. A157 (m ²)	Price gr. A211 (m ²)	Price gr. A187 (m ²)	Price gr. A259 (m ²)	Price gr. A313 (m ²)	3 medium blue <input type="checkbox"/>
702-2008H	705-2008H	710-2008H	712-2008H	703-2008H¹	552008-341550HK¹	552008-352010HK¹	2 dark blue <input type="checkbox"/>
Price gr. A250 (m ²)	Price gr. A211 (m ²)	Price gr. A157 (m ²)	Price gr. A178 (m ²)	Price gr. A187 (m ²)	Price gr. A259 (m ²)	Price gr. A313 (m ²)	2 dark blue <input type="checkbox"/>
	705-2009H	710-2009H	712-2009H¹	703-2009H¹	552009-341550HK¹	552009-352010HK¹	2 active turquoise <input type="checkbox"/>
	Price gr. A211 (m ²)	Price gr. A157 (m ²)	Price gr. A211 (m ²)	Price gr. A187 (m ²)	Price gr. A259 (m ²)	Price gr. A313 (m ²)	2 active turquoise <input type="checkbox"/>
702-2010H¹	705-2010H	710-2010H	712-2010H¹	703-2010H¹	552010-341550HK¹	552010-352010HK¹	4 light turquoise <input type="checkbox"/>
Price gr. A280 (m ²)	Price gr. A211 (m ²)	Price gr. A157 (m ²)	Price gr. A211 (m ²)	Price gr. A187 (m ²)	Price gr. A259 (m ²)	Price gr. A313 (m ²)	4 light turquoise <input type="checkbox"/>
702-2011H¹	705-2011H	710-2011H	712-2011H¹	703-2011H¹	552011-341550HK¹	552011-352010HK¹	3 medium turquoise <input type="checkbox"/>
Price gr. A280 (m ²)	Price gr. A211 (m ²)	Price gr. A157 (m ²)	Price gr. A211 (m ²)	Price gr. A187 (m ²)	Price gr. A259 (m ²)	Price gr. A313 (m ²)	3 medium turquoise <input type="checkbox"/>
702-2012H¹	705-2012H	710-2012H	712-2012H	703-2012H^{1/4}	552012-341550HK^{1/4}	552012-352010HK^{1/4}	2 dark turquoise <input type="checkbox"/>
Price gr. A280 (m ²)	Price gr. A211 (m ²)	Price gr. A157 (m ²)	Price gr. A178 (m ²)	Price gr. A187 (m ²)	Price gr. A259 (m ²)	Price gr. A313 (m ²)	2 dark turquoise <input type="checkbox"/>
	705-2013H	710-2013H	712-2013H¹	703-2013H¹	552013-341550HK¹	552013-352010HK¹	2 active green <input type="checkbox"/>
	Price gr. A211 (m ²)	Price gr. A157 (m ²)	Price gr. A211 (m ²)	Price gr. A187 (m ²)	Price gr. A259 (m ²)	Price gr. A313 (m ²)	2 active green <input type="checkbox"/>
702-2014H¹	705-2014H	710-2014H	712-2014H¹	703-2014H¹	552014-341550HK¹	552014-352010HK¹	4 light green <input type="checkbox"/>
Price gr. A280 (m ²)	Price gr. A211 (m ²)	Price gr. A157 (m ²)	Price gr. A211 (m ²)	Price gr. A187 (m ²)	Price gr. A259 (m ²)	Price gr. A313 (m ²)	4 light green <input type="checkbox"/>
702-2015H¹	705-2015H	710-2015H	712-2015H¹	703-2015H¹	552015-341550HK¹	552015-352010HK¹	3 medium green <input type="checkbox"/>
Price gr. A280 (m ²)	Price gr. A211 (m ²)	Price gr. A157 (m ²)	Price gr. A211 (m ²)	Price gr. A187 (m ²)	Price gr. A259 (m ²)	Price gr. A313 (m ²)	3 medium green <input type="checkbox"/>
702-2016H¹	705-2016H	710-2016H	712-2016H	703-2016H¹	552016-341550HK¹	552016-352010HK¹	2 dark green <input type="checkbox"/>
Price gr. A280 (m ²)	Price gr. A211 (m ²)	Price					

Floor/Wall Tiles

15 x 15 cm



20 x 20 cm



25 x 50 cm²



30 x 30 cm²



30 x 60 cm²

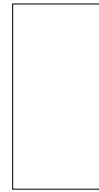

50 x 100 cm²

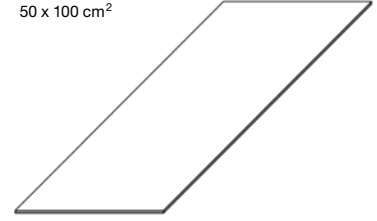

Model number	15 x 15 cm	20 x 20 cm	25 x 50 cm ²	30 x 30 cm ²	30 x 60 cm ²	50 x 100 cm ²
Nom. dim. - cm/in	15 x 15 / 6 x 6	20 x 20 / 8 x 8	25 x 50 / 10 x 20	30 x 30 / 12 x 12	30 x 60 / 12 x 24	50 x 100 / 20 x 40
Work size	147 x 147 x 6.5 mm	197 x 197 x 6.5 mm	247 x 497 x 8 mm	297 x 297 x 8 mm	297 x 597 x 8 mm	497 x 997 x 8 mm
Surface	smooth, for op-theat.	smooth, for op-theat.	smooth, silky-matt ⁴	smooth, silky-matt ⁴	smooth, silky-matt ⁴	smooth, silky-matt ⁴
m ² - pieces	44.000	25.000	8.000	11.111	5.556	2.000
m ² - kg	13.816	13.875	17.040	17.222	17.413	18.080
Bundle - pieces	44	25	9	14	6	2
Bundle - m ²	1.000	1.000	1.125	1.260	1.080	1.000
Bundle - kg	13.816	13.875	19.170	21.700	18.804	18.080
Pallet - m ²	80.000	72.000	40.500	52.921	43.197	52.000
Pallet - kg	1,105.280	999.000	690.120	911.400	752.160	940.160
Product standard	Blb	Blb	Alb	Alb	Alb	Alb
Stress group	1	1	1	2	1	1
neutral 10 (active white gl.)	4 715-2121H NEW Price gr. A115 (m ²)	720-2121H NEW Price gr. A115 (m ²)	700i-342550HK Price gr. A157 (m ²)	730-2121H Price gr. A166 (m ²)	760-2121H Price gr. A166 (m ²)	700i-352050HK Price gr. A211 (m ²)
neutral 10 (active white)	4 715-2120H Price gr. A115 (m ²)	720-2120H Price gr. A115 (m ²)	701i-342550HK Price gr. A157 (m ²)	730-2120H Price gr. A166 (m ²)	760-2120H Price gr. A166 (m ²)	701i-352050HK Price gr. A211 (m ²)
neutral 9 (white grey)	4 715-2119H¹ Price gr. A166 (m ²)	720-2119H¹ Price gr. A166 (m ²)	552119-342550HK Price gr. A181 (m ²)	730-2119H¹ Price gr. A217 (m ²)	760-2119H¹ Price gr. A217 (m ²)	552119-352050HK¹ Price gr. A259 (m ²)
neutral 8 (light-grey)	4 715-2118H Price gr. A115 (m ²)	720-2118H Price gr. A115 (m ²)	552118-342550HK Price gr. A157 (m ²)	730-2118H Price gr. A166 (m ²)	760-2118H Price gr. A166 (m ²)	552118-352050HK Price gr. A211 (m ²)
neutral 7 (pebble-grey)	4 715-2117H¹ Price gr. A166 (m ²)	720-2117H¹ Price gr. A166 (m ²)	552117-342550HK Price gr. A181 (m ²)	730-2117H¹ Price gr. A217 (m ²)	760-2117H¹ Price gr. A217 (m ²)	552117-352050HK Price gr. A229 (m ²)
neutral 6 (pearl-grey)	3 715-2116H¹ Price gr. A166 (m ²)	720-2116H¹ Price gr. A166 (m ²)				
neutral 5 (basalt grey)	3 715-2115H¹ Price gr. A166 (m ²)	720-2115H¹ Price gr. A166 (m ²)	552115-342550HK Price gr. A181 (m ²)	730-2115H¹ Price gr. A217 (m ²)	760-2115H¹ Price gr. A217 (m ²)	552115-352050HK¹ Price gr. A259 (m ²)
neutral 4 (graphite black)	3 715-2114H Price gr. A142 (m ²)	720-2114H Price gr. A142 (m ²)				
neutral 3 (asphalt black)	3 715-2113H¹ Price gr. A166 (m ²)	720-2113H¹ Price gr. A166 (m ²)	552113-342550HK Price gr. A181 (m ²)	730-2113H Price gr. A187 (m ²)	760-2113H Price gr. A187 (m ²)	552113-352050HK Price gr. A229 (m ²)
neutral 2 (anthracite)	2 715-2112H Price gr. A142 (m ²)	720-2112H Price gr. A142 (m ²)	552112-342550HK Price gr. A181 (m ²)	730-2112H¹ Price gr. A217 (m ²)	760-2112H Price gr. A187 (m ²)	552112-352050HK¹ Price gr. A259 (m ²)
neutral 1 (deep black)	1 715-2111H Price gr. A142 (m ²)	720-2111H Price gr. A142 (m ²)	5716-342550HK³ Price gr. A181 (m ²)	730-2111H³ Price gr. A217 (m ²)	760-2111H^{1,3} Price gr. A217 (m ²)	5716-352050HK^{1,3} Price gr. A259 (m ²)
active azure	2 715-2001H¹ Price gr. A166 (m ²)	720-2001H¹ Price gr. A166 (m ²)	552001-342550HK Price gr. A181 (m ²)	730-2001H Price gr. A187 (m ²)	760-2001H Price gr. A187 (m ²)	552001-352050HK Price gr. A229 (m ²)
light azure	4 715-2002H¹ Price gr. A166 (m ²)	720-2002H¹ Price gr. A166 (m ²)	552002-342550HK Price gr. A181 (m ²)	730-2002H¹ Price gr. A217 (m ²)	760-2002H¹ Price gr. A217 (m ²)	552002-352050HK¹ Price gr. A259 (m ²)
medium azure	3 715-2003H Price gr. A142 (m ²)	720-2003H Price gr. A142 (m ²)	552003-342550HK Price gr. A181 (m ²)	730-2003H Price gr. A187 (m ²)	760-2003H Price gr. A187 (m ²)	552003-352050HK Price gr. A229 (m ²)
dark azure	2 715-2004H¹ Price gr. A166 (m ²)	720-2004H Price gr. A142 (m ²)	552004-342550HK Price gr. A181 (m ²)	730-2004H¹ Price gr. A217 (m ²)	760-2004H¹ Price gr. A217 (m ²)	552004-352050HK¹ Price gr. A259 (m ²)
active blue	2 715-2005H¹ Price gr. A166 (m ²)	720-2005H¹ Price gr. A166 (m ²)	552005-342550HK Price gr. A181 (m ²)	730-2005H¹ Price gr. A217 (m ²)	760-2005H¹ Price gr. A217 (m ²)	552005-352050HK¹ Price gr. A259 (m ²)
light blue	4 715-2006H¹ Price gr. A166 (m ²)	720-2006H¹ Price gr. A166 (m ²)	552006-342550HK Price gr. A181 (m ²)	730-2006H¹ Price gr. A217 (m ²)	760-2006H¹ Price gr. A217 (m ²)	552006-352050HK¹ Price gr. A259 (m ²)
medium blue	3 715-2007H Price gr. A142 (m ²)	720-2007H Price gr. A142 (m ²)	552007-342550HK Price gr. A181 (m ²)	730-2007H¹ Price gr. A217 (m ²)	760-2007H¹ Price gr. A217 (m ²)	552007-352050HK¹ Price gr. A259 (m ²)
dark blue	2 715-2008H¹ Price gr. A166 (m ²)	720-2008H Price gr. A142 (m ²)	552008-342550HK Price gr. A181 (m ²)	730-2008H¹ Price gr. A217 (m ²)	760-2008H¹ Price gr. A217 (m ²)	552008-352050HK¹ Price gr. A259 (m ²)
active turquoise	2 715-2009H¹ Price gr. A166 (m ²)	720-2009H¹ Price gr. A166 (m ²)	552009-342550HK Price gr. A181 (m ²)	730-2009H¹ Price gr. A217 (m ²)	760-2009H¹ Price gr. A217 (m ²)	552009-352050HK¹ Price gr. A259 (m ²)
light turquoise	4 715-2010H Price gr. A142 (m ²)	720-2010H Price gr. A142 (m ²)	552010-342550HK Price gr. A181 (m ²)	730-2010H¹ Price gr. A217 (m ²)	760-2010H¹ Price gr. A217 (m ²)	552010-352050HK¹ Price gr. A259 (m ²)
medium turquoise	3 715-2011H¹ Price gr. A166 (m ²)	720-2011H¹ Price gr. A166 (m ²)	552011-342550HK Price gr. A181 (m ²)	730-2011H¹ Price gr. A217 (m ²)	760-2011H¹ Price gr. A217 (m ²)	552011-352050HK¹ Price gr. A259 (m ²)
dark turquoise	2 715-2012H¹ Price gr. A166 (m ²)	720-2012H¹ Price gr. A166 (m ²)	552012-342550HK³ Price gr. A181 (m ²)	730-2012H^{1,3} Price gr. A217 (m ²)	760-2012H^{1,3} Price gr. A217 (m ²)	552012-352050HK^{1,3} Price gr. A259 (m ²)
active green	2 715-2013H¹ Price gr. A166 (m ²)	720-2013H¹ Price gr. A166 (m ²)	552013-342550HK Price gr. A181 (m ²)	730-2013H¹ Price gr. A217 (m ²)	760-2013H¹ Price gr. A217 (m ²)	552013-352050HK¹ Price gr. A259 (m ²)
light green	4 715-2014H Price gr. A142 (m ²)	720-2014H Price gr. A142 (m ²)	552014-342550HK Price gr. A181 (m ²)	730-2014H¹ Price gr. A217 (m ²)	760-2014H¹ Price gr. A217 (m ²)	552014-352050HK¹ Price gr. A259 (m ²)
medium green	3 715-2015H¹ Price gr. A166 (m ²)	720-2015H¹ Price gr. A166 (m ²)	552015-342550HK Price gr. A181 (m ²)	730-2015H¹ Price gr. A217 (m ²)	760-2015H¹ Price gr. A217 (m ²)	552015-352050HK¹ Price gr. A259 (m ²)
dark green	2 715-2016H¹ Price gr. A166 (m ²)	720-2016H¹ Price gr. A166 (m ²)	552016-342550HK Price gr. A181 (m ²)	730-2016H¹ Price gr. A217 (m ²)	760-2016H¹ Price gr. A217 (m ²)	552016-352050HK¹ Price gr. A259 (m ²)



³ Production-related color deviations from the standard are possible.
⁴ Exception: neutral 10 (glossy), smooth, glossy

Mosaic

Floor/Wall Tiles

2.5 x 2.5 cm^{3/5}

5 x 5 cm^{3/5}

10 x 10 cm^{3/5/6}

10 x 20 cm **NEW**

10 x 30 cm

12.5 x 50 cm²

12.5 x 100 cm²

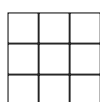
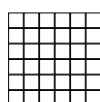
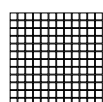

Sheet: 297 x 297 mm

Sheet: 297 x 297 mm

Sheet: 297 x 297 mm

2.5 x 2.5 / 1 x 1 23 x 23 x 6.5 mm smooth, for op-theat. 11 sheets 12.100 11 sheets 1.000 12.100 48.000 580.800 Blb 1	5 x 5 / 2 x 2 47 x 47 x 6.5 mm smooth, for op-theat. 11 sheets 12.331 11 sheets 1.000 12.331 64.000 789.184 Blb 1	10 x 10 / 4 x 4 97 x 97 x 6.5 mm smooth, for op-theat. 11 sheets 13.101 11 sheets 1.000 13.101 64.000 838.464 Blb 1	10 x 20 / 4 x 8 97 x 197 x 6.5 mm smooth, for op-theat. 50.000 13.600 33 0.660 8.976 59.400 807.840 Blb 1	703 10 x 30 / 4 x 12 97 x 297 x 6 mm smooth, silky-matt 33.330 12.333 38 1.140 14.060 95.770 1,181.040 Alb 1	341550HK 12.5 x 50 / 5 x 20 122 x 497 x 8 mm smooth, silky-matt 16.000 17.040 8 0.500 8.520 55.000 937.200 Alb 1	352010HK 12.5 x 100 / 5 x 40 122 x 997 x 8 mm smooth, silky-matt 8.000 17.040 10 1.250 21.300 67.500 1,150.200 Alb 1	Model number Nom. dim. - cm/in Work size Surface m ² - pieces m ² - kg Bundle - pieces Bundle - m ² Bundle - kg Pallet - m ² Pallet - kg Product standard Stress group	
702-2018H ¹ Price gr. A280 (m ²)	705-2017H Price gr. A211 (m ²)	710-2017H Price gr. A157 (m ²)	712-2017H ¹ Price gr. A211 (m ²)	703-2017H ^{1/4} Price gr. A187 (m ²)	552017-341550HK ^{1/4} Price gr. A259 (m ²)	552017-352010HK ^{1/4} Price gr. A313 (m ²)	2	active yellow <input type="checkbox"/>
702-2019H ¹ Price gr. A280 (m ²)	705-2018H Price gr. A211 (m ²)	710-2018H Price gr. A157 (m ²)	712-2018H ¹ Price gr. A211 (m ²)	703-2018H ¹ Price gr. A187 (m ²)	552018-341550HK ¹ Price gr. A259 (m ²)	552018-352010HK ¹ Price gr. A313 (m ²)	4	light yellow <input type="checkbox"/>
702-2020H ¹ Price gr. A280 (m ²)	705-2019H Price gr. A211 (m ²)	710-2019H Price gr. A157 (m ²)	712-2019H ¹ Price gr. A211 (m ²)	703-2019H ¹ Price gr. A187 (m ²)	552019-341550HK ¹ Price gr. A259 (m ²)	552019-352010HK ¹ Price gr. A313 (m ²)	3	medium yellow <input type="checkbox"/>
702-2021H ¹ Price gr. A280 (m ²)	705-2020H Price gr. A211 (m ²)	710-2020H Price gr. A157 (m ²)	712-2020H Price gr. A178 (m ²)	703-2020H ^{1/4} Price gr. A187 (m ²)	552020-341550HK ^{1/4} Price gr. A259 (m ²)	552020-352010HK ^{1/4} Price gr. A313 (m ²)	2	dark yellow <input type="checkbox"/>
702-2022H ¹ Price gr. A280 (m ²)	705-2021H Price gr. A211 (m ²)	710-2021H Price gr. A157 (m ²)	712-2021H ¹ Price gr. A211 (m ²)	703-2021H ^{1/4} Price gr. A187 (m ²)	552021-341550HK ^{1/4} Price gr. A259 (m ²)	552021-352010HK ^{1/4} Price gr. A313 (m ²)	2	active ochre <input type="checkbox"/>
702-2023H ¹ Price gr. A280 (m ²)	705-2022H Price gr. A211 (m ²)	710-2022H Price gr. A157 (m ²)	712-2022H ¹ Price gr. A211 (m ²)	703-2022H ¹ Price gr. A187 (m ²)	552022-341550HK ¹ Price gr. A259 (m ²)	552022-352010HK ¹ Price gr. A313 (m ²)	4	light ochre <input type="checkbox"/>
702-2024H ¹ Price gr. A280 (m ²)	705-2023H Price gr. A211 (m ²)	710-2023H Price gr. A157 (m ²)	712-2023H ¹ Price gr. A211 (m ²)	703-2023H ¹ Price gr. A187 (m ²)	552023-341550HK ¹ Price gr. A259 (m ²)	552023-352010HK ¹ Price gr. A313 (m ²)	3	medium ochre <input type="checkbox"/>
702-2025H ¹ Price gr. A280 (m ²)	705-2024H Price gr. A211 (m ²)	710-2024H Price gr. A157 (m ²)	712-2024H Price gr. A178 (m ²)	703-2024H ¹ Price gr. A187 (m ²)	552024-341550HK ¹ Price gr. A259 (m ²)	552024-352010HK ¹ Price gr. A313 (m ²)	2	dark ochre <input type="checkbox"/>
702-2026H ¹ Price gr. A280 (m ²)	705-2025H Price gr. A211 (m ²)	710-2025H Price gr. A157 (m ²)	712-2025H Price gr. A211 (m ²)	703-2025H ^{1/4} Price gr. A187 (m ²)	552025-341550HK ^{1/4} Price gr. A259 (m ²)	552025-352010HK ^{1/4} Price gr. A313 (m ²)	2	active salmon <input type="checkbox"/>
702-2027H ¹ Price gr. A280 (m ²)	705-2026H Price gr. A211 (m ²)	710-2026H Price gr. A157 (m ²)	712-2026H Price gr. A211 (m ²)	703-2026H ¹ Price gr. A187 (m ²)	552026-341550HK ¹ Price gr. A259 (m ²)	552026-352010HK ¹ Price gr. A313 (m ²)	4	light salmon <input type="checkbox"/>
702-2028H ¹ Price gr. A280 (m ²)	705-2027H Price gr. A211 (m ²)	710-2027H Price gr. A157 (m ²)	712-2027H Price gr. A211 (m ²)	703-2027H ¹ Price gr. A187 (m ²)	552027-341550HK ¹ Price gr. A259 (m ²)	552027-352010HK ¹ Price gr. A313 (m ²)	3	medium salmon <input type="checkbox"/>
702-2029H ¹ Price gr. A280 (m ²)	705-2028H Price gr. A211 (m ²)	710-2028H Price gr. A157 (m ²)	712-2028H Price gr. A178 (m ²)	703-2028H ¹ Price gr. A187 (m ²)	552028-341550HK ¹ Price gr. A259 (m ²)	552028-352010HK ¹ Price gr. A313 (m ²)	2	dark salmon <input type="checkbox"/>
702-2030H ¹ Price gr. A280 (m ²)	705-2029H Price gr. A211 (m ²)	710-2029H Price gr. A157 (m ²)	712-2029H ¹ Price gr. A211 (m ²)	703-2029H ¹ Price gr. A187 (m ²)	552029-341550HK ¹ Price gr. A259 (m ²)	552029-352010HK ¹ Price gr. A313 (m ²)	2	active oxide red <input type="checkbox"/>
702-2031H ¹ Price gr. A280 (m ²)	705-2030H Price gr. A211 (m ²)	710-2030H Price gr. A157 (m ²)	712-2030H ¹ Price gr. A211 (m ²)	703-2030H ¹ Price gr. A187 (m ²)	552030-341550HK ¹ Price gr. A259 (m ²)	552030-352010HK ¹ Price gr. A313 (m ²)	4	light oxide red <input type="checkbox"/>
702-2032H ¹ Price gr. A280 (m ²)	705-2031H Price gr. A211 (m ²)	710-2031H Price gr. A157 (m ²)	712-2031H ¹ Price gr. A211 (m ²)	703-2031H ¹ Price gr. A187 (m ²)	552031-341550HK ¹ Price gr. A259 (m ²)	552031-352010HK ¹ Price gr. A313 (m ²)	3	medium oxide red <input type="checkbox"/>
702-2033H ¹ Price gr. A280 (m ²)	705-2032H Price gr. A211 (m ²)	710-2032H Price gr. A157 (m ²)	712-2032H Price gr. A178 (m ²)	703-2032H ¹ Price gr. A187 (m ²)	552032-341550HK ¹ Price gr. A259 (m ²)	552032-352010HK ¹ Price gr. A313 (m ²)	2	dark oxide red <input type="checkbox"/>
702-2034H ¹ Price gr. A280 (m ²)	705-2033H Price gr. A211 (m ²)	710-2033H Price gr. A157 (m ²)	712-2033H ¹ Price gr. A211 (m ²)	703-2033H ¹ Price gr. A187 (m ²)	552033-341550HK ¹ Price gr. A259 (m ²)	552033-352010HK ¹ Price gr. A313 (m ²)	2	active stone grey <input type="checkbox"/>
702-2035H ¹ Price gr. A280 (m ²)	705-2034H Price gr. A211 (m ²)	710-2034H Price gr. A157 (m ²)	712-2034H ¹ Price gr. A211 (m ²)	703-2034H ¹ Price gr. A187 (m ²)	552034-341550HK ¹ Price gr. A259 (m ²)	552034-352010HK ¹ Price gr. A313 (m ²)	4	light stone grey <input type="checkbox"/>
702-2036H Price gr. A280 (m ²)	705-2035H Price gr. A211 (m ²)	710-2035H Price gr. A157 (m ²)	712-2035H ¹ Price gr. A211 (m ²)	703-2035H Price gr. A157 (m ²)	552035-341550HK Price gr. A229 (m ²)	552035-352010HK Price gr. A289 (m ²)	3	medium stone grey <input type="checkbox"/>
702-2037H ¹ Price gr. A280 (m ²)	705-2036H Price gr. A211 (m ²)	710-2036H Price gr. A157 (m ²)	712-2036H Price gr. A178 (m ²)	703-2036H ¹ Price gr. A187 (m ²)	552036-341550HK ¹ Price gr. A259 (m ²)	552036-352010HK ¹ Price gr. A313 (m ²)	2	dark stone grey <input type="checkbox"/>
702-2038H ¹ Price gr. A280 (m ²)	705-2037H Price gr. A211 (m ²)	710-2037H Price gr. A157 (m ²)	712-2037H ¹ Price gr. A211 (m ²)	703-2037H ¹ Price gr. A187 (m ²)	552037-341550HK ¹ Price gr. A259 (m ²)	552037-352010HK ¹ Price gr. A313 (m ²)	2	active sand-grey <input type="checkbox"/>
702-2039H ¹ Price gr. A280 (m ²)	705-2038H Price gr. A211 (m ²)	710-2038H Price gr. A157 (m ²)	712-2038H ¹ Price gr. A211 (m ²)	703-2038H ¹ Price gr. A187 (m ²)	552038-341550HK ¹ Price gr. A259 (m ²)	552038-352010HK ¹ Price gr. A313 (m ²)	4	light sand-grey <input type="checkbox"/>
702-2040H Price gr. A280 (m ²)	705-2039H Price gr. A211 (m ²)	710-2039H Price gr. A157 (m ²)	712-2039H ¹ Price gr. A211 (m ²)	703-2039H Price gr. A157 (m ²)	552039-341550HK Price gr. A229 (m ²)	552039-352010HK Price gr. A289 (m ²)	3	medium sand-grey <input type="checkbox"/>
	705-2040H Price gr. A211 (m ²)	710-2040H Price gr. A157 (m ²)	712-2040H Price gr. A178 (m ²)	703-2040H ¹ Price gr. A187 (m ²)	552040-341550HK ¹ Price gr. A259 (m ²)	552040-352010HK ¹ Price gr. A313 (m ²)	2	dark sand-grey <input type="checkbox"/>



⁴ Production-related color deviations from the standard are possible.
⁵ Upon request, defined color gradients and mosaic pictures can also be supplied.
⁶ Overglazed edges proportionately in the sheet
 Shower tub system, refer to series Plural non-slip, page 363/365



Floor/Wall Tiles

15 x 15 cm



20 x 20 cm



25 x 50 cm²



30 x 30 cm²



30 x 60 cm²

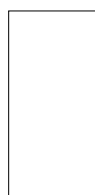

50 x 100 cm²

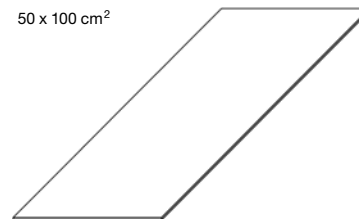

Model number	15 x 15 cm	20 x 20 cm	25 x 50 cm ²	30 x 30 cm ²	30 x 60 cm ²	50 x 100 cm ²
Nom. dim. - cm/in	15 x 15 / 6 x 6	20 x 20 / 8 x 8	25 x 50 / 10 x 20	30 x 30 / 12 x 12	30 x 60 / 12 x 24	50 x 100 / 20 x 40
Work size	147 x 147 x 6.5 mm	197 x 197 x 6.5 mm	247 x 497 x 8 mm	297 x 297 x 8 mm	297 x 597 x 8 mm	497 x 997 x 8 mm
Surface	smooth, for op-theat.	smooth, for op-theat.	smooth, silky-matt	smooth, silky-matt	smooth, silky-matt	smooth, silky-matt
m ² - pieces	44.000	25.000	8.000	11.111	5.556	2.000
m ² - kg	13.816	13.875	17.040	17.222	17.413	18.080
Bundle - pieces	44	25	9	14	6	2
Bundle - m ²	1.000	1.000	1.125	1.260	1.080	1.000
Bundle - kg	13.816	13.875	19.170	21.700	18.804	18.080
Pallet - m ²	80.000	72.000	40.500	52.921	43.197	52.000
Pallet - kg	1,105.280	999.000	690.120	911.400	752.160	940.160
Product standard	Blb	Blb	Alb	Alb	Alb	Alb
Stress group	1	1	1	2	1	1
active yellow <input type="checkbox"/>	2 715-2017H ¹ Price gr. A166 (m ²)	720-2017H Price gr. A142 (m ²)	552017-342550HK ³ Price gr. A181 (m ²)	730-2017H ^{1/3} Price gr. A217 (m ²)	760-2017H ^{1/3} Price gr. A217 (m ²)	552017-352050HK ^{1/3} Price gr. A259 (m ²)
light yellow <input type="checkbox"/>	4 715-2018H Price gr. A142 (m ²)	720-2018H Price gr. A142 (m ²)	552018-342550HK Price gr. A181 (m ²)	730-2018H ¹ Price gr. A217 (m ²)	760-2018H ¹ Price gr. A217 (m ²)	552018-352050HK ¹ Price gr. A259 (m ²)
medium yellow <input type="checkbox"/>	3 715-2019H ¹ Price gr. A166 (m ²)	720-2019H ¹ Price gr. A166 (m ²)	552019-342550HK Price gr. A181 (m ²)	730-2019H ¹ Price gr. A217 (m ²)	760-2019H ¹ Price gr. A217 (m ²)	552019-352050HK ¹ Price gr. A259 (m ²)
dark yellow <input type="checkbox"/>	2 715-2020H ¹ Price gr. A166 (m ²)	720-2020H ¹ Price gr. A166 (m ²)	552020-342550HK ³ Price gr. A181 (m ²)	730-2020H ^{1/3} Price gr. A217 (m ²)	760-2020H ^{1/3} Price gr. A217 (m ²)	552020-352050HK ^{1/3} Price gr. A259 (m ²)
active ochre <input type="checkbox"/>	2 715-2021H ¹ Price gr. A166 (m ²)	720-2021H ¹ Price gr. A166 (m ²)	552021-342550HK ³ Price gr. A181 (m ²)	730-2021H ^{1/3} Price gr. A217 (m ²)	760-2021H ^{1/3} Price gr. A217 (m ²)	552021-352050HK ^{1/3} Price gr. A259 (m ²)
light ochre <input type="checkbox"/>	4 715-2022H Price gr. A142 (m ²)	720-2022H Price gr. A142 (m ²)	552022-342550HK Price gr. A181 (m ²)	730-2022H ¹ Price gr. A217 (m ²)	760-2022H ¹ Price gr. A217 (m ²)	552022-352050HK ¹ Price gr. A259 (m ²)
medium ochre <input type="checkbox"/>	3 715-2023H ¹ Price gr. A166 (m ²)	720-2023H ¹ Price gr. A166 (m ²)	552023-342550HK Price gr. A181 (m ²)	730-2023H ¹ Price gr. A217 (m ²)	760-2023H ¹ Price gr. A217 (m ²)	552023-352050HK ¹ Price gr. A259 (m ²)
dark ochre <input type="checkbox"/>	2 715-2024H ¹ Price gr. A166 (m ²)	720-2024H ¹ Price gr. A166 (m ²)	552024-342550HK Price gr. A181 (m ²)	730-2024H ¹ Price gr. A217 (m ²)	760-2024H ¹ Price gr. A217 (m ²)	552024-352050HK ¹ Price gr. A259 (m ²)
active salmon <input type="checkbox"/>	2 715-2025H ¹ Price gr. A166 (m ²)	720-2025H ¹ Price gr. A166 (m ²)	552025-342550HK ³ Price gr. A181 (m ²)	730-2025H ^{1/3} Price gr. A217 (m ²)	760-2025H ^{1/3} Price gr. A217 (m ²)	552025-352050HK ^{1/3} Price gr. A259 (m ²)
light salmon <input type="checkbox"/>	4 715-2026H Price gr. A142 (m ²)	720-2026H ¹ Price gr. A166 (m ²)	552026-342550HK Price gr. A181 (m ²)	730-2026H ¹ Price gr. A217 (m ²)	760-2026H ¹ Price gr. A217 (m ²)	552026-352050HK ¹ Price gr. A259 (m ²)
medium salmon <input type="checkbox"/>	3 715-2027H Price gr. A142 (m ²)	720-2027H Price gr. A142 (m ²)	552027-342550HK Price gr. A181 (m ²)	730-2027H ¹ Price gr. A217 (m ²)	760-2027H ¹ Price gr. A217 (m ²)	552027-352050HK ¹ Price gr. A259 (m ²)
dark salmon <input type="checkbox"/>	2 715-2028H ¹ Price gr. A166 (m ²)	720-2028H ¹ Price gr. A166 (m ²)	552028-342550HK Price gr. A181 (m ²)	730-2028H ¹ Price gr. A217 (m ²)	760-2028H ¹ Price gr. A217 (m ²)	552028-352050HK ¹ Price gr. A259 (m ²)
active oxide red <input type="checkbox"/>	2 715-2029H ¹ Price gr. A166 (m ²)	720-2029H ¹ Price gr. A166 (m ²)	552029-342550HK Price gr. A181 (m ²)	730-2029H ¹ Price gr. A217 (m ²)	760-2029H ¹ Price gr. A217 (m ²)	552029-352050HK ¹ Price gr. A259 (m ²)
light oxide red <input type="checkbox"/>	4 715-2030H ¹ Price gr. A166 (m ²)	720-2030H ¹ Price gr. A166 (m ²)	552030-342550HK Price gr. A181 (m ²)	730-2030H ¹ Price gr. A217 (m ²)	760-2030H ¹ Price gr. A217 (m ²)	552030-352050HK ¹ Price gr. A259 (m ²)
medium oxide red <input type="checkbox"/>	3 715-2031H Price gr. A142 (m ²)	720-2031H Price gr. A142 (m ²)	552031-342550HK Price gr. A181 (m ²)	730-2031H ¹ Price gr. A217 (m ²)	760-2031H ¹ Price gr. A217 (m ²)	552031-352050HK ¹ Price gr. A259 (m ²)
dark oxide red <input type="checkbox"/>	2 715-2032H ¹ Price gr. A166 (m ²)	720-2032H ¹ Price gr. A166 (m ²)	552032-342550HK Price gr. A181 (m ²)	730-2032H ¹ Price gr. A217 (m ²)	760-2032H ¹ Price gr. A217 (m ²)	552032-352050HK ¹ Price gr. A259 (m ²)
active stone grey <input type="checkbox"/>	2 715-2033H ¹ Price gr. A166 (m ²)	720-2033H ¹ Price gr. A166 (m ²)	552033-342550HK Price gr. A181 (m ²)	730-2033H ¹ Price gr. A217 (m ²)	760-2033H ¹ Price gr. A217 (m ²)	552033-352050HK ¹ Price gr. A259 (m ²)
light stone grey <input type="checkbox"/>	4 715-2034H ¹ Price gr. A166 (m ²)	720-2034H ¹ Price gr. A166 (m ²)	552034-342550HK Price gr. A181 (m ²)	730-2034H ¹ Price gr. A217 (m ²)	760-2034H ¹ Price gr. A217 (m ²)	552034-352050HK ¹ Price gr. A259 (m ²)
medium stone grey <input type="checkbox"/>	3 715-2035H ¹ Price gr. A166 (m ²)	720-2035H ¹ Price gr. A166 (m ²)	552035-342550HK Price gr. A181 (m ²)	730-2035H Price gr. A187 (m ²)	760-2035H Price gr. A187 (m ²)	552035-352050HK Price gr. A229 (m ²)
dark stone grey <input type="checkbox"/>	2 715-2036H Price gr. A142 (m ²)	720-2036H Price gr. A142 (m ²)	552036-342550HK Price gr. A181 (m ²)	730-2036H ¹ Price gr. A217 (m ²)	760-2036H ¹ Price gr. A217 (m ²)	552036-352050HK ¹ Price gr. A259 (m ²)
active sand-grey <input type="checkbox"/>	2 715-2037H ¹ Price gr. A166 (m ²)	720-2037H ¹ Price gr. A166 (m ²)	552037-342550HK Price gr. A181 (m ²)	730-2037H ¹ Price gr. A217 (m ²)	760-2037H ¹ Price gr. A217 (m ²)	552037-352050HK ¹ Price gr. A259 (m ²)
light sand-grey <input type="checkbox"/>	4 715-2038H Price gr. A142 (m ²)	720-2038H Price gr. A142 (m ²)	552038-342550HK Price gr. A181 (m ²)	730-2038H ¹ Price gr. A217 (m ²)	760-2038H ¹ Price gr. A217 (m ²)	552038-352050HK ¹ Price gr. A259 (m ²)
medium sand-grey <input type="checkbox"/>	3 715-2039H Price gr. A142 (m ²)	720-2039H Price gr. A142 (m ²)	552039-342550HK Price gr. A181 (m ²)	730-2039H Price gr. A187 (m ²)	760-2039H Price gr. A187 (m ²)	552039-352050HK Price gr. A229 (m ²)
dark sand-grey <input type="checkbox"/>	2 715-2040H Price gr. A142 (m ²)	720-2040H Price gr. A142 (m ²)	552040-342550HK Price gr. A181 (m ²)	730-2040H ¹ Price gr. A217 (m ²)	760-2040H ¹ Price gr. A217 (m ²)	552040-352050HK ¹ Price gr. A259 (m ²)



³ Production-related color deviations from the standard are possible.

Mosaic **NEW** Floor/ **NEW**
Wall Tiles

10 x 10 cm¹



20 x 20 cm¹



Sheet: 297 x 297 mm

					10 x 10 / 4 x 4	20 x 20 / 8 x 8			Nom. dim. - cm/in
					97 x 97 x 6.5 mm	197 x 197 x 6.5 mm			Work size
					smooth, for op-theat.	smooth, for op-theat.			Surface
					11.000	25.000			m ² - pieces
					13.101	13.875			m ² - kg
					11	25			Bundle - pieces
					1.000	1.000			Bundle - m ²
					13.101	13.875			Bundle - kg
					64.000	72.000			Pallet - m ²
					838.464	999.000			Pallet - kg
					Blb	Blb			Product standard
					1	1			Stress group
					710-2041H	720-2041H			violet <input type="checkbox"/>
					Price gr. A196 (m ²)	Price gr. A181 (m ²)			
					710-2042H	720-2042H			berry red <input type="checkbox"/>
					Price gr. A196 (m ²)	Price gr. A181 (m ²)			
					710-2043H	720-2043H			brown red <input type="checkbox"/>
					Price gr. A196 (m ²)	Price gr. A181 (m ²)			
					710-2044H	720-2044H			fire red <input type="checkbox"/>
					Price gr. A196 (m ²)	Price gr. A181 (m ²)			
					710-2045H	720-2045H			signal orange <input type="checkbox"/>
					Price gr. A196 (m ²)	Price gr. A181 (m ²)			
					710-2046H	720-2046H			sunshine yellow <input type="checkbox"/>
					Price gr. A196 (m ²)	Price gr. A181 (m ²)			
					710-2047H	720-2047H			yellow green <input type="checkbox"/>
					Price gr. A196 (m ²)	Price gr. A181 (m ²)			
					710-2048H	720-2048H			sea green <input type="checkbox"/>
					Price gr. A196 (m ²)	Price gr. A181 (m ²)			
					710-2049H	720-2049H			blue green <input type="checkbox"/>
					Price gr. A196 (m ²)	Price gr. A181 (m ²)			
					710-2050H	720-2050H			cobalt blue <input type="checkbox"/>
					Price gr. A196 (m ²)	Price gr. A181 (m ²)			



Cove Skirting¹

Internal Corner for Cove Skirting¹

External Corner for Cove Skirting¹

10 x 10 cm



Nom. dim. - cm/in	10 x 10 / 4 x 4	100 x 18 x 6.5 mm	100 x 18 x 6.5 mm			
Work size	100 x 97 x 6.5 mm	100 x 18 x 6.5 mm	100 x 18 x 6.5 mm			
Surface	smooth, silky-matt	smooth, silky-matt	smooth, silky-matt			
m - pieces	10.000					
m/pce. - kg	1.500/m	0.030/piece	0.030/piece			
Bundle - pieces	40	40	30			
Bundle - m	4.000					
Bundle - kg	6.000					
Pallet - m						
Pallet - kg						
Product standard	B1b	B1b	B1b			
Stress group	1	1	1			
neutral 10 (active white) <input type="checkbox"/>	4 763-2120H Price gr. A416 (pce.)	759-2120H Price gr. A430 (pce.)	761-2120H Price gr. A430 (pce.)			
neutral 9 (white grey) <input type="checkbox"/>	4	759-2119H Price gr. A430 (pce.)	761-2119H Price gr. A430 (pce.)			
neutral 8 (light-grey) <input type="checkbox"/>	4 763-2118H Price gr. A416 (pce.)	759-2118H Price gr. A430 (pce.)	761-2118H Price gr. A430 (pce.)			
neutral 7 (pebble-grey) <input type="checkbox"/>	4	759-2117H Price gr. A430 (pce.)	761-2117H Price gr. A430 (pce.)			
neutral 5 (basalt grey) <input type="checkbox"/>	3 763-2115H Price gr. A416 (pce.)	759-2115H Price gr. A430 (pce.)	761-2115H Price gr. A430 (pce.)			
neutral 3 (asphalt black) <input type="checkbox"/>	3	759-2113H Price gr. A430 (pce.)	761-2113H Price gr. A430 (pce.)			
neutral 1 (deep black) <input type="checkbox"/>	1 763-2111H Price gr. A416 (pce.)	759-2111H Price gr. A430 (pce.)	761-2111H Price gr. A430 (pce.)			
active azure <input type="checkbox"/>	2	759-2001H Price gr. A430 (pce.)	761-2001H Price gr. A430 (pce.)			
light azure <input type="checkbox"/>	4	759-2002H Price gr. A430 (pce.)	761-2002H Price gr. A430 (pce.)			
medium azure <input type="checkbox"/>	3 763-2003H Price gr. A416 (pce.)	759-2003H Price gr. A430 (pce.)	761-2003H Price gr. A430 (pce.)			
dark azure <input type="checkbox"/>	2	759-2004H Price gr. A430 (pce.)	761-2004H Price gr. A430 (pce.)			
light blue <input type="checkbox"/>	4	759-2006H Price gr. A430 (pce.)	761-2006H Price gr. A430 (pce.)			
medium blue <input type="checkbox"/>	3	759-2007H Price gr. A430 (pce.)	761-2007H Price gr. A430 (pce.)			
dark blue <input type="checkbox"/>	2	759-2008H Price gr. A430 (pce.)	761-2008H Price gr. A430 (pce.)			
medium turquoise <input type="checkbox"/>	3	759-2011H Price gr. A430 (pce.)	761-2011H Price gr. A430 (pce.)			
medium green <input type="checkbox"/>	3	759-2015H Price gr. A430 (pce.)	761-2015H Price gr. A430 (pce.)			
dark green <input type="checkbox"/>	2	759-2016H Price gr. A430 (pce.)	761-2016H Price gr. A430 (pce.)			
medium yellow <input type="checkbox"/>	3	759-2019H Price gr. A430 (pce.)	761-2019H Price gr. A430 (pce.)			
medium ochre <input type="checkbox"/>	3	759-2023H Price gr. A430 (pce.)	761-2023H Price gr. A430 (pce.)			
medium salmon <input type="checkbox"/>	3	759-2027H Price gr. A430 (pce.)	761-2027H Price gr. A430 (pce.)			
medium oxide red <input type="checkbox"/>	3	759-2031H Price gr. A430 (pce.)	761-2031H Price gr. A430 (pce.)			
light stone grey <input type="checkbox"/>	4 763-2034H Price gr. A416 (pce.)	759-2034H Price gr. A430 (pce.)	761-2034H Price gr. A430 (pce.)			
dark stone grey <input type="checkbox"/>	2 763-2036H Price gr. A416 (pce.)	759-2036H Price gr. A430 (pce.)	761-2036H Price gr. A430 (pce.)			
active sand-grey <input type="checkbox"/>	2 763-2037H Price gr. A416 (pce.)	759-2037H Price gr. A430 (pce.)	761-2037H Price gr. A430 (pce.)			
dark sand-grey <input type="checkbox"/>	2 763-2040H Price gr. A416 (pce.)	759-2040H Price gr. A430 (pce.)	761-2040H Price gr. A430 (pce.)			

¹ For details, refer to page 536
Color deviations compared to the adjoining covering due to production are
no reason for complaint in case of horizontal laying.



Juice bar "The Juizza" in the opera passage, Vienna, Austria / Architect: Schubert und Schubert ZT-GmbH, Vienna, Austria / Photo: Christoph Panzer







360 Plural non-slip stoneware

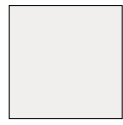

2120/2121
neutral 10 (active white)



2119
neutral 9 (white-grey)



2118
neutral 8 (light-grey)



2117
neutral 7 (pebble-grey)



2116
neutral 6 (pearl grey)



2115
neutral 5 (basalt-grey)



2114
neutral 4 (graphite-black)



2113
neutral 3 (asphalt black)



2112
neutral 2 (anthracite)



2111
neutral 1 (deep black)



2004
dark azure



2008
dark blue



2012
dark turquoise



2016
dark green



2020
dark yellow



2024
dark ochre



2028
dark salmon



2032
dark oxid red



2036
dark stone grey



2040
dark sand grey



2003
medium azure



2007
medium blue



2011
medium turquoise



2015
medium green



2019
medium yellow



2023
medium ochre



2027
medium salmon



2031
medium oxid red



2035
medium stone grey



2039
medium sand grey



2002
light azure

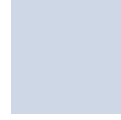

2006
light blue



2010
light turquoise



2014
light green



2018
light yellow



2022
light ochre



2026
light salmon



2030
light oxid red



2034
light stone grey



2038
light sand grey



2001
active azure



2005
active blue



2009
active turquoise



2013
active green



2017
active yellow



2021
active ochre



2025
active salmon



2029
active oxid red



2033
active stone grey



2037
active sand grey

Mosaic 2.5 x 2.5 cm, 1 x 1 in

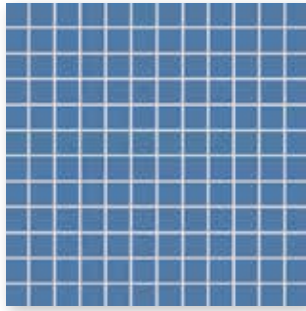

Mosaic sheet 30 x 30 cm, 12 x 12 in,
smooth, R10/B



Cove skirting
10 x 10 cm, 4 x 4 in
smooth, R10/B



Shower tub system Corner
10 x 10 cm, 4 x 4 in
smooth, R10/B



Internal
corner,
smooth



External
corner,
smooth



Shower tub system Strip,
10 x 10 cm, 4 x 4 in
smooth, R10/B

Mosaic 5 x 5 cm, 2 x 2 in

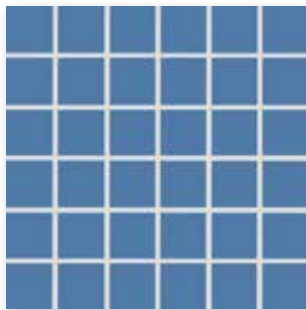

Mosaic sheet 30 x 30 cm, 12 x 12 in,
smooth, R10/B

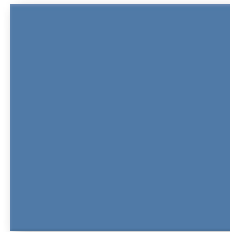

Floor tile 20 x 20 cm, 8 x 8 in,
smooth, R10/B

Mosaic 10 x 10 cm, 4 x 4 in

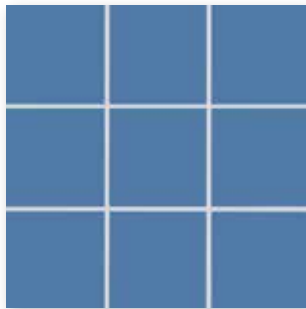

Mosaic sheet 30 x 30 cm, 12 x 12 in,
smooth, R10/B



Floor tile 30 x 60 cm, 12 x 24 in, smooth, R10/B



Mosaics glued thermoplastically on back of Agrob Buchtal can be used not only in dry zones but also without any problems in underwater areas (e.g. swimming pools/whirlpools) as well as in permanently wet areas (e.g. pool surrounds/showers).

Do you already know our Mosaic Designer at our website www.agrob-buchtal.com? There, you will have the possibility of designing your individual color gradients, mosaic compositions and the laying of pictures.

362 Plural non-slip stoneware

Dry-pressed Ceramic Tiles, DIN EN 14411, group Bl_b, glazed (GL) for floor and wall coverings in indoor and outdoor areas (stoneware tiles)// Extruded Ceramic Tiles, Precision, DIN EN 14411, group Al_b, glazed (GL) for floor and wall coverings in indoor and outdoor areas (stoneware tiles)

Mosaic^{2/4}

2.5 x 2.5 cm

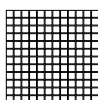

5 x 5 cm

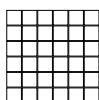

10 x 10 cm

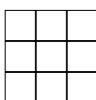

Wall/Floor Tiles

20 x 20 cm



30 x 60 cm^{1/3}



	Sheet: 297 x 297 mm	Sheet: 297 x 297 mm	Sheet: 297 x 297 mm	20 x 20 / 8 x 8	30 x 60 / 12 x 24
Nom. dim. - cm/in	2.5 x 2.5 / 1 x 1	5 x 5 / 2 x 2	10 x 10 / 4 x 4	20 x 20 / 8 x 8	30 x 60 / 12 x 24
Work size	23 x 23 x 6.5 mm	47 x 47 x 6.5 mm	97 x 97 x 6.5 mm	197 x 197 x 6.5 mm	297 x 597 x 8 mm
Surface	smooth, matt	smooth, matt	smooth, matt	smooth, matt	smooth, matt
m ² - pieces	11 sheets	11 sheets	11 sheets	25.000	5.556
m ² - kg	12.100	12.331	13.101	13.875	17.413
Bundle - pieces	11 sheets	11 sheets	11 sheets	25	6
Bundle - m ²	1.000	1.000	1.000	1.000	1.080
Bundle - kg	12.100	12.331	13.101	13.875	18.804
Pallet - m ²	48.000	64.000	64.000	72.000	43.197
Pallet - kg	580.800	789.184	838.464	999.000	752.160
Product standard	Blb	Blb	Blb	Blb	Alb
Slip resistance	R10/B	R10/B	R10/B	R10/B	R10/B
Stress group	1	1	1	1	2
Stress group	4	4	4	4	4
neutral 10 (active white)	902-2120H Price gr. A238 (m ²)	905-2120H Price gr. A205 (m ²)	910-2120H Price gr. A166 (m ²)	920-2120H Price gr. A148 (m ²)	980-2120H Price gr. A181 (m ²)
neutral 9 (white grey)	902-2119H¹ Price gr. A289 (m ²)	905-2119H¹ Price gr. A250 (m ²)	910-2119H Price gr. A190 (m ²)	920-2119H¹ Price gr. A190 (m ²)	
neutral 8 (light-grey)	902-2118H Price gr. A238 (m ²)	905-2118H Price gr. A205 (m ²)	910-2118H Price gr. A166 (m ²)	920-2118H Price gr. A148 (m ²)	980-2118H Price gr. A205 (m ²)
neutral 7 (pebble-grey)	902-2117H¹ Price gr. A289 (m ²)	905-2117H¹ Price gr. A256 (m ²)	910-2117H Price gr. A190 (m ²)	920-2117H¹ Price gr. A190 (m ²)	
neutral 6 (pearl-grey)	902-2116H¹ Price gr. A289 (m ²)	905-2116H¹ Price gr. A256 (m ²)	910-2116H¹ Price gr. A223 (m ²)	920-2116H¹ Price gr. A190 (m ²)	
neutral 5 (basalt grey)	902-2115H¹ Price gr. A289 (m ²)	905-2115H¹ Price gr. A256 (m ²)	910-2115H Price gr. A190 (m ²)	920-2115H Price gr. A166 (m ²)	
neutral 4 (graphite black)	902-2114H¹ Price gr. A289 (m ²)	905-2114H¹ Price gr. A256 (m ²)	910-2114H Price gr. A190 (m ²)	920-2114H Price gr. A166 (m ²)	
neutral 3 (asphalt black)	902-2113H¹ Price gr. A289 (m ²)	905-2113H¹ Price gr. A256 (m ²)	910-2113H Price gr. A190 (m ²)	920-2113H¹ Price gr. A190 (m ²)	
neutral 2 (anthracite)	902-2112H¹ Price gr. A289 (m ²)	905-2112H¹ Price gr. A256 (m ²)	910-2112H Price gr. A190 (m ²)	920-2112H Price gr. A166 (m ²)	
neutral 1 (deep black)	902-2111H Price gr. A259 (m ²)	905-2111H Price gr. A229 (m ²)	910-2111H Price gr. A190 (m ²)	920-2111H Price gr. A166 (m ²)	980-2111H Price gr. A181 (m ²)
active azure	902-2001H¹ Price gr. A289 (m ²)	905-2001H¹ Price gr. A256 (m ²)	910-2001H Price gr. A190 (m ²)	920-2001H¹ Price gr. A190 (m ²)	
light azure	902-2002H¹ Price gr. A289 (m ²)	905-2002H¹ Price gr. A256 (m ²)	910-2002H Price gr. A190 (m ²)	920-2002H¹ Price gr. A190 (m ²)	
medium azure	902-2003H Price gr. A259 (m ²)	905-2003H Price gr. A229 (m ²)	910-2003H Price gr. A190 (m ²)	920-2003H Price gr. A166 (m ²)	980-2003H Price gr. A205 (m ²)
dark azure	902-2004H Price gr. A259 (m ²)	905-2004H¹ Price gr. A256 (m ²)	910-2004H Price gr. A190 (m ²)	920-2004H Price gr. A166 (m ²)	
active blue	902-2005H¹ Price gr. A289 (m ²)	905-2005H¹ Price gr. A256 (m ²)	910-2005H¹ Price gr. A223 (m ²)	920-2005H¹ Price gr. A190 (m ²)	
light blue	902-2006H¹ Price gr. A289 (m ²)	905-2006H¹ Price gr. A256 (m ²)	910-2006H Price gr. A190 (m ²)	920-2006H¹ Price gr. A190 (m ²)	
medium blue	902-2007H¹ Price gr. A289 (m ²)	905-2007H¹ Price gr. A256 (m ²)	910-2007H Price gr. A190 (m ²)	920-2007H Price gr. A166 (m ²)	980-2007H Price gr. A205 (m ²)
dark blue	902-2008H Price gr. A259 (m ²)	905-2008H Price gr. A229 (m ²)	910-2008H Price gr. A190 (m ²)	920-2008H Price gr. A166 (m ²)	
active turquoise	902-2009H¹ Price gr. A289 (m ²)	905-2009H¹ Price gr. A256 (m ²)	910-2009H¹ Price gr. A223 (m ²)	920-2009H¹ Price gr. A190 (m ²)	
light turquoise	902-2010H¹ Price gr. A289 (m ²)	905-2010H¹ Price gr. A256 (m ²)	910-2010H¹ Price gr. A223 (m ²)	920-2010H¹ Price gr. A190 (m ²)	
medium turquoise	902-2011H¹ Price gr. A289 (m ²)	905-2011H¹ Price gr. A256 (m ²)	910-2011H Price gr. A190 (m ²)	920-2011H Price gr. A166 (m ²)	980-2011H Price gr. A205 (m ²)
dark turquoise	902-2012H¹ Price gr. A289 (m ²)	905-2012H¹ Price gr. A256 (m ²)	910-2012H¹ Price gr. A223 (m ²)	920-2012H¹ Price gr. A190 (m ²)	
active green	902-2013H¹ Price gr. A289 (m ²)	905-2013H¹ Price gr. A256 (m ²)	910-2013H¹ Price gr. A223 (m ²)	920-2013H¹ Price gr. A190 (m ²)	
light green	902-2014H¹ Price gr. A289 (m ²)	905-2014H Price gr. A229 (m ²)	910-2014H¹ Price gr. A223 (m ²)	920-2014H¹ Price gr. A190 (m ²)	
medium green	902-2015H¹ Price gr. A289 (m ²)	905-2015H¹ Price gr. A256 (m ²)	910-2015H Price gr. A190 (m ²)	920-2015H Price gr. A166 (m ²)	980-2015H Price gr. A205 (m ²)
dark green	902-2016H¹ Price gr. A289 (m ²)	905-2016H¹ Price gr. A256 (m ²)	910-2016H Price gr. A190 (m ²)	920-2016H Price gr. A166 (m ²)	

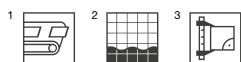

⁴ Upon request, defined color gradients and mosaic pictures can also be supplied.

Cove Skirting^{1/3}

Internal Corner for Cove Skirting^{1/3}

External Corner for Cove Skirting^{1/3}

Shower Tub System²

10 x 10 cm



10 x 10 cm



10 x 10 cm



						Strip		Corner		Stress group	Nom. dim. - cm/in	
		10 x 10 / 4 x 4	100 x 18 x 6.5 mm	100 x 18 x 6.5 mm	100 x 18 x 6.5 mm	10 x 10 / 4 x 4	10 x 10 / 4 x 4	10 x 10 / 4 x 4	10 x 10 / 4 x 4			Work size
		100 x 97 x 6.5 mm	smooth, matt	10.000	1.500/m	40	4.000	6.000	Blb	R10/B	4	neutral 10 (active white) <input type="checkbox"/>
		100 x 97 x 6.5 mm	smooth, matt	10.000	1.700/m	16	1.600	2.720	Blb	R10/B	4	neutral 9 (white grey) <input type="checkbox"/>
		100 x 97 x 6.5 mm	smooth, matt	10.000	1.700/m	16	1.600	2.720	Blb	R10/B	4	neutral 8 (light-grey) <input type="checkbox"/>
		100 x 97 x 6.5 mm	smooth, matt	10.000	1.700/m	16	1.600	2.720	Blb	R10/B	4	neutral 7 (pebble-grey) <input type="checkbox"/>
		100 x 97 x 6.5 mm	smooth, matt	10.000	1.700/m	16	1.600	2.720	Blb	R10/B	3	neutral 5 (basalt grey) <input type="checkbox"/>
		100 x 97 x 6.5 mm	smooth, matt	10.000	1.700/m	16	1.600	2.720	Blb	R10/B	3	neutral 3 (asphalt black) <input type="checkbox"/>
		100 x 97 x 6.5 mm	smooth, matt	10.000	1.700/m	16	1.600	2.720	Blb	R10/B	1	neutral 1 (deep black) <input type="checkbox"/>
		100 x 97 x 6.5 mm	smooth, matt	10.000	1.700/m	16	1.600	2.720	Blb	R10/B	2	active azure <input type="checkbox"/>
		100 x 97 x 6.5 mm	smooth, matt	10.000	1.700/m	16	1.600	2.720	Blb	R10/B	4	light azure <input type="checkbox"/>
		100 x 97 x 6.5 mm	smooth, matt	10.000	1.700/m	16	1.600	2.720	Blb	R10/B	3	medium azure <input type="checkbox"/>
		100 x 97 x 6.5 mm	smooth, matt	10.000	1.700/m	16	1.600	2.720	Blb	R10/B	2	dark azure <input type="checkbox"/>
		100 x 97 x 6.5 mm	smooth, matt	10.000	1.700/m	16	1.600	2.720	Blb	R10/B	4	light blue <input type="checkbox"/>
		100 x 97 x 6.5 mm	smooth, matt	10.000	1.700/m	16	1.600	2.720	Blb	R10/B	3	medium blue <input type="checkbox"/>
		100 x 97 x 6.5 mm	smooth, matt	10.000	1.700/m	16	1.600	2.720	Blb	R10/B	2	dark blue <input type="checkbox"/>
		100 x 97 x 6.5 mm	smooth, matt	10.000	1.700/m	16	1.600	2.720	Blb	R10/B	3	medium turquoise <input type="checkbox"/>
		100 x 97 x 6.5 mm	smooth, matt	10.000	1.700/m	16	1.600	2.720	Blb	R10/B	3	medium green <input type="checkbox"/>
		100 x 97 x 6.5 mm	smooth, matt	10.000	1.700/m	16	1.600	2.720	Blb	R10/B	2	dark green <input type="checkbox"/>

¹ For details, refer to page 536

² For details, refer to page 534

³ Color deviations compared to the adjoining covering due to production are no reason for complaint in case of horizontal laying.



364 Plural non-slip stoneware

Dry-pressed Ceramic Tiles, DIN EN 14411, group Bl₁, glazed (GL) for floor and wall coverings in indoor and outdoor areas (stoneware tiles)// Extruded Ceramic Tiles, Precision, DIN EN 14411, group Al₁, glazed (GL) for floor and wall coverings in indoor and outdoor areas (stoneware tiles)

Mosaic^{2/4}

2.5 x 2.5 cm

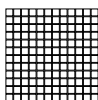

5 x 5 cm

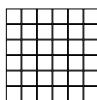

10 x 10 cm

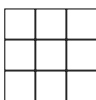

Wall/Floor Tiles

20 x 20 cm



30 x 60 cm^{1/3}

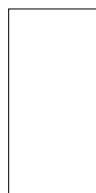

Sheet: 297 x 297 mm

Sheet: 297 x 297 mm

Sheet: 297 x 297 mm

Nom. dim. - cm/in	2.5 x 2.5 / 1 x 1	5 x 5 / 2 x 2	10 x 10 / 4 x 4	20 x 20 / 8 x 8	30 x 60 / 12 x 24		
Work size	23 x 23 x 6.5 mm	47 x 47 x 6.5 mm	97 x 97 x 6.5 mm	197 x 197 x 6.5 mm	297 x 597 x 8 mm		
Surface	smooth, matt	smooth, matt	smooth, matt	smooth, matt	smooth, matt		
m ² - pieces	11 sheets	11 sheets	11 sheets	25.000	5.556		
m ² - kg	12.100	12.331	13.101	13.875	17.413		
Bundle - pieces	11 sheets	11 sheets	11 sheets	25	6		
Bundle - m ²	1.000	1.000	1.000	1.000	1.080		
Bundle - kg	12.100	12.331	13.101	13.875	18.804		
Pallet - m ²	48.000	64.000	64.000	72.000	43.197		
Pallet - kg	580.800	789.184	838.464	999.000	752.160		
Product standard	Blb	Blb	Blb	Blb	Alb		
Slip resistance	R10/B	R10/B	R10/B	R10/B	R10/B		
Stress group	1	1	1	1	2		
active yellow <input type="checkbox"/>	2 902-2017H ¹ Price gr. A289 (m ²)	905-2017H ¹ Price gr. A256 (m ²)	910-2017H ¹ Price gr. A223 (m ²)	920-2017H ¹ Price gr. A190 (m ²)			
light yellow <input type="checkbox"/>	4 902-2018H ¹ Price gr. A289 (m ²)	905-2018H ¹ Price gr. A256 (m ²)	910-2018H ¹ Price gr. A223 (m ²)	920-2018H ¹ Price gr. A190 (m ²)			
medium yellow <input type="checkbox"/>	3 902-2019H ¹ Price gr. A289 (m ²)	905-2019H ¹ Price gr. A256 (m ²)	910-2019H Price gr. A190 (m ²)	920-2019H Price gr. A166 (m ²)	980-2019H Price gr. A205 (m ²)		
dark yellow <input type="checkbox"/>	2 902-2020H ¹ Price gr. A289 (m ²)	905-2020H ¹ Price gr. A256 (m ²)	910-2020H ¹ Price gr. A223 (m ²)	920-2020H ¹ Price gr. A190 (m ²)			
active ochre <input type="checkbox"/>	2 902-2021H ¹ Price gr. A289 (m ²)	905-2021H ¹ Price gr. A256 (m ²)	910-2021H ¹ Price gr. A223 (m ²)	920-2021H ¹ Price gr. A190 (m ²)			
light ochre <input type="checkbox"/>	4 902-2022H ¹ Price gr. A289 (m ²)	905-2022H ¹ Price gr. A256 (m ²)	910-2022H Price gr. A190 (m ²)	920-2022H ¹ Price gr. A190 (m ²)			
medium ochre <input type="checkbox"/>	3 902-2023H ¹ Price gr. A289 (m ²)	905-2023H ¹ Price gr. A256 (m ²)	910-2023H Price gr. A190 (m ²)	920-2023H Price gr. A166 (m ²)	980-2023H Price gr. A205 (m ²)		
dark ochre <input type="checkbox"/>	2 902-2024H ¹ Price gr. A289 (m ²)	905-2024H ¹ Price gr. A256 (m ²)	910-2024H ¹ Price gr. A223 (m ²)	920-2024H ¹ Price gr. A190 (m ²)			
active salmon <input type="checkbox"/>	2 902-2025H ¹ Price gr. A289 (m ²)	905-2025H ¹ Price gr. A256 (m ²)	910-2025H ¹ Price gr. A223 (m ²)	920-2025H ¹ Price gr. A190 (m ²)			
light salmon <input type="checkbox"/>	4 902-2026H ¹ Price gr. A289 (m ²)	905-2026H ¹ Price gr. A256 (m ²)	910-2026H ¹ Price gr. A223 (m ²)	920-2026H ¹ Price gr. A190 (m ²)			
medium salmon <input type="checkbox"/>	3 902-2027H ¹ Price gr. A289 (m ²)	905-2027H Price gr. A229 (m ²)	910-2027H Price gr. A190 (m ²)	920-2027H Price gr. A166 (m ²)	980-2027H Price gr. A205 (m ²)		
dark salmon <input type="checkbox"/>	2 902-2028H ¹ Price gr. A289 (m ²)	905-2028H ¹ Price gr. A256 (m ²)	910-2028H ¹ Price gr. A223 (m ²)	920-2028H Price gr. A166 (m ²)			
active oxide red <input type="checkbox"/>	2 902-2029H ¹ Price gr. A289 (m ²)	905-2029H Price gr. A229 (m ²)	910-2029H ¹ Price gr. A223 (m ²)	920-2029H ¹ Price gr. A190 (m ²)			
light oxide red <input type="checkbox"/>	4 902-2030H ¹ Price gr. A289 (m ²)	905-2030H ¹ Price gr. A256 (m ²)	910-2030H ¹ Price gr. A223 (m ²)	920-2030H ¹ Price gr. A190 (m ²)			
medium oxide red <input type="checkbox"/>	3 902-2031H ¹ Price gr. A289 (m ²)	905-2031H ¹ Price gr. A256 (m ²)	910-2031H Price gr. A190 (m ²)	920-2031H Price gr. A166 (m ²)	980-2031H Price gr. A205 (m ²)		
dark oxide red <input type="checkbox"/>	2 902-2032H ¹ Price gr. A289 (m ²)	905-2032H ¹ Price gr. A256 (m ²)	910-2032H ¹ Price gr. A223 (m ²)	920-2032H ¹ Price gr. A190 (m ²)			
active stone grey <input type="checkbox"/>	2 902-2033H ¹ Price gr. A289 (m ²)	905-2033H ¹ Price gr. A256 (m ²)	910-2033H Price gr. A190 (m ²)	920-2033H ¹ Price gr. A190 (m ²)			
light stone grey <input type="checkbox"/>	4 902-2034H ¹ Price gr. A289 (m ²)	905-2034H ¹ Price gr. A256 (m ²)	910-2034H Price gr. A190 (m ²)	920-2034H ¹ Price gr. A190 (m ²)			
medium stone grey <input type="checkbox"/>	3 902-2035H ¹ Price gr. A289 (m ²)	905-2035H ¹ Price gr. A256 (m ²)	910-2035H Price gr. A190 (m ²)	920-2035H Price gr. A190 (m ²)			
dark stone grey <input type="checkbox"/>	2 902-2036H ¹ Price gr. A259 (m ²)	905-2036H Price gr. A229 (m ²)	910-2036H Price gr. A190 (m ²)	920-2036H Price gr. A166 (m ²)			
active sand-grey <input type="checkbox"/>	2 902-2037H ¹ Price gr. A289 (m ²)	905-2037H ¹ Price gr. A256 (m ²)	910-2037H Price gr. A190 (m ²)	920-2037H ¹ Price gr. A190 (m ²)			
light sand-grey <input type="checkbox"/>	4 902-2038H ¹ Price gr. A289 (m ²)	905-2038H Price gr. A229 (m ²)	910-2038H Price gr. A190 (m ²)	920-2038H Price gr. A166 (m ²)			
medium sand-grey <input type="checkbox"/>	3 902-2039H ¹ Price gr. A289 (m ²)	905-2039H Price gr. A229 (m ²)	910-2039H Price gr. A190 (m ²)	920-2039H Price gr. A166 (m ²)	980-2039H Price gr. A205 (m ²)		
dark sand-grey <input type="checkbox"/>	2 902-2040H Price gr. A259 (m ²)	905-2040H Price gr. A229 (m ²)	910-2040H Price gr. A190 (m ²)	920-2040H Price gr. A166 (m ²)			

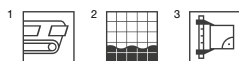

⁴ Upon request, defined color gradients and mosaic pictures can also be supplied.

Cove Skirting^{1/3}

10 x 10 cm



Internal Corner for Cove Skirting^{1/3}



External Corner for Cove Skirting^{1/3}



Shower Tub System²

10 x 10 cm



10 x 10 cm



					Strip	Corner	
	10 x 10 / 4 x 4	100 x 18 x 6.5 mm	100 x 18 x 6.5 mm	100 x 18 x 6.5 mm	10 x 10 / 4 x 4	10 x 10 / 4 x 4	
	100 x 97 x 6.5 mm	100 x 97 x 6.5 mm	100 x 97 x 6.5 mm	100 x 97 x 6.5 mm	97 x 97 x 6.5 mm	97 x 97 x 6.5 mm	Nom. dim. - cm/in
	smooth, matt	smooth, matt	smooth, matt	smooth, matt	smooth, matt	smooth, matt	Work size
	10.000				10.000		Surface
	1.500/m	0.030/piece	0.030/piece	0.030/piece	1.700/m	0.170/piece	m - pieces
	40	40	30	30	16	4	m/pce. - kg
	4.000				1.600		Bundle - pieces
	6.000				2.720	0.680	Bundle - m
							Bundle - kg
							Pallet - m
							Pallet - kg
	Blb	Blb	Blb	Blb	Blb	Blb	Product standard
	R10/B				R10/B	R10/B	Slip resistance
							Stress group
	764-2019H	759-2019H	761-2019H	761-2019H	785-2019H	786-2019H	3
	Price gr. A418 (pce.)	Price gr. A430 (pce.)	Price gr. A430 (pce.)	Price gr. A430 (pce.)	Price gr. A428 (pce.)	Price gr. A455 (pce.)	medium yellow
	764-2023H	759-2023H	761-2023H	761-2023H	785-2023H	786-2023H	3
	Price gr. A418 (pce.)	Price gr. A430 (pce.)	Price gr. A430 (pce.)	Price gr. A430 (pce.)	Price gr. A428 (pce.)	Price gr. A455 (pce.)	medium ochre
	764-2027H	759-2027H	761-2027H	761-2027H	785-2027H	786-2027H	3
	Price gr. A418 (pce.)	Price gr. A430 (pce.)	Price gr. A430 (pce.)	Price gr. A430 (pce.)	Price gr. A428 (pce.)	Price gr. A455 (pce.)	medium salmon
	764-2031H	759-2031H	761-2031H	761-2031H	785-2031H	786-2031H	3
	Price gr. A418 (pce.)	Price gr. A430 (pce.)	Price gr. A430 (pce.)	Price gr. A430 (pce.)	Price gr. A428 (pce.)	Price gr. A455 (pce.)	medium oxide red
	764-2034H	759-2034H	761-2034H	761-2034H	785-2034H	786-2034H	4
	Price gr. A418 (pce.)	Price gr. A430 (pce.)	Price gr. A430 (pce.)	Price gr. A430 (pce.)	Price gr. A428 (pce.)	Price gr. A455 (pce.)	light stone grey
	764-2036H	759-2036H	761-2036H	761-2036H	785-2036H	786-2036H	2
	Price gr. A418 (pce.)	Price gr. A430 (pce.)	Price gr. A430 (pce.)	Price gr. A430 (pce.)	Price gr. A428 (pce.)	Price gr. A455 (pce.)	dark stone grey
	764-2037H	759-2037H	761-2037H	761-2037H	785-2037H	786-2037H	2
	Price gr. A418 (pce.)	Price gr. A430 (pce.)	Price gr. A430 (pce.)	Price gr. A430 (pce.)	Price gr. A428 (pce.)	Price gr. A455 (pce.)	active sand-grey
	764-2040H	759-2040H	761-2040H	761-2040H	785-2040H	786-2040H	2
	Price gr. A418 (pce.)	Price gr. A430 (pce.)	Price gr. A430 (pce.)	Price gr. A430 (pce.)	Price gr. A428 (pce.)	Price gr. A455 (pce.)	dark sand-grey

¹ For details, refer to page 536

² For details, refer to page 534

³ Color deviations compared to the adjoining covering due to production are no reason for complaint in case of horizontal laying.



Hauswirtschaftsschule (home economics school), Sankt Gallen, Switzerland / Architect: Architekturbüro Daniel Cavelti, Photo: Adriano Faragulo





368 Plural unglazed
porcelain stoneware



R10/B R11/C



2008
dark blue



2040
dark sand grey



2016
dark green



2041
medium brown



2023
medium ochre



2042
medium grey



2033
active stone grey



2043
medium sand beige

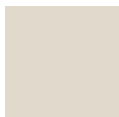

2038
sand-white



2111
neutral 1 (deep black)



2039
medium sand grey



2113
neutral 3 (asphalt black)

Mosaic 2.5 x 2.5 cm, 1 x 1 in

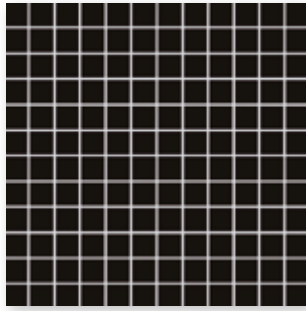

Mosaic sheet 30 x 30 cm, 12 x 12 in, smooth, R10/B



Floor tile 15 x 15 cm, 6 x 6 in, smooth, R10/B
Floor tile 15 x 15 cm, 6 x 6 in, relief, R11/C



Cove skirting
10 x 10 cm, 4 x 4 in, smooth, R10/B



Shower tub system Corner
10 x 10 cm, 4 x 4 in, smooth, R10/B

Mosaic 5 x 5 cm, 2 x 2 in

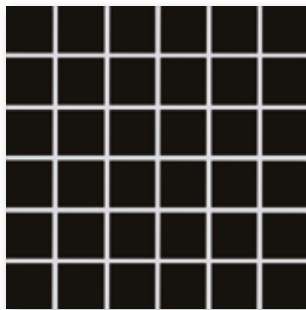

Mosaic sheet 30 x 30 cm, 12 x 12 in, smooth, R10/B



Floor tile 20 x 20 cm, 8 x 8 in, smooth, R10/B



Shower tub system Strip
10 x 10 cm, 4 x 4 in, smooth, R10/B

Mosaic 10 x 10 cm, 4 x 4 in

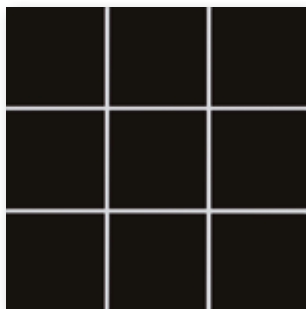

Mosaic sheet 30 x 30 cm, 12 x 12 in, smooth, R10/B
Mosaic sheet 30 x 30 cm, 12 x 12 in, relief, R11/C



Floor tile 30 x 60 cm, 12 x 24 in, smooth, R10/B



Mosaics glued thermoplastically on back of Agrob Buchtal can be used not only in dry zones but also without any problems in underwater areas (e.g. swimming pools/whirlpools) as well as in permanently wet areas (e.g. pool surrounds/showers).

370 Plural unglazed porcelain stoneware

Dry-pressed Ceramic Tiles, DIN EN 14411, group BI_a, unglazed (UGL)
for floor and wall coverings in indoor and outdoor areas (porcelain stoneware tiles)

Mosaic^{2/3}

Floor Tiles



protected

2.5 x 2.5 cm

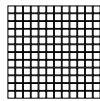

Sheet: 297 x 297 mm

5 x 5 cm

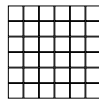

Sheet: 297 x 297 mm

10 x 10 cm

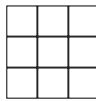

Sheet: 297 x 297 mm

10 x 10 cm

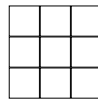

Sheet: 297 x 297 mm

15 x 15 cm



15 x 15 cm



Nom. dim. - cm/in	2.5 x 2.5 / 1 x 1	5 x 5 / 2 x 2	10 x 10 / 4 x 4	10 x 10 / 4 x 4	15 x 15 / 6 x 6	15 x 15 / 6 x 6
Work size	23 x 23 x 6.5 mm	47 x 47 x 6.5 mm	97 x 97 x 6.5 mm	97 x 97 x 6.5 mm	147 x 147 x 6.5 mm	147 x 147 x 6.5 mm
Surface	smooth, matt	smooth, matt	smooth, matt	relief, matt	smooth, matt	relief, matt
m ² - pieces	11 sheets	11 sheets	11 sheets	11 sheets	44.000	44.000
m ² - kg	12.100	12.331	13.101	13.101	13.816	13.816
Bundle - pieces	11 sheets	11 sheets	11 sheets	11 sheets	44	44
Bundle - m ²	1.000	1.000	1.000	1.000	1.000	1.000
Bundle - kg	12.100	12.331	13.101	13.101	13.816	13.816
Pallet - m ²	48.000	64.000	64.000	64.000	80.000	80.000
Pallet - kg	580.800	789.184	838.464	838.464	1,105.280	1,105.280
Product standard	Bla	Bla	Bla	Bla	Bla	Bla
Slip resistance	R10/B	R10/B	R10/B	R11/C	R10/B	R11/C
Stress group	1	1	1	1	1	1
neutral 3	410-2113	610-2113	810-2113	811-2113	812-2113	813-2113
(asphalt black) <input type="checkbox"/>	Price gr. A199 (m ²)	Price gr. A175 (m ²)	Price gr. A136 (m ²)	Price gr. A166 (m ²)	Price gr. A127 (m ²)	Price gr. A148 (m ²)
neutral 1	410-2111	610-2111	810-2111	811-2111	812-2111	813-2111
(deep black) <input type="checkbox"/>	Price gr. A199 (m ²)	Price gr. A175 (m ²)	Price gr. A136 (m ²)	Price gr. A166 (m ²)	Price gr. A127 (m ²)	Price gr. A148 (m ²)
dark blue <input type="checkbox"/>	410-2008	610-2008	810-2008		812-2008 ¹ NEW	
	Price gr. A238 (m ²)	Price gr. A211 (m ²)	Price gr. A175 (m ²)		Price gr. A160 (m ²)	
dark green <input type="checkbox"/>	410-2016 ¹ NEW	610-2016	810-2016		812-2016 ¹ NEW	
	Price gr. A253 (m ²)	Price gr. A211 (m ²)	Price gr. A175 (m ²)		Price gr. A160 (m ²)	
medium ochre <input type="checkbox"/>	410-2023	610-2023	810-2023		812-2023 ¹ NEW	
	Price gr. A238 (m ²)	Price gr. A211 (m ²)	Price gr. A175 (m ²)		Price gr. A160 (m ²)	
active stone grey <input type="checkbox"/>	410-2033 ¹ NEW	610-2033	810-2033		812-2033 ¹ NEW	
	Price gr. A253 (m ²)	Price gr. A211 (m ²)	Price gr. A175 (m ²)		Price gr. A160 (m ²)	
sand-white <input type="checkbox"/>	410-2038	610-2038	810-2038	811-2038	812-2038	813-2038
medium	Price gr. A199 (m ²)	Price gr. A175 (m ²)	Price gr. A136 (m ²)	Price gr. A166 (m ²)	Price gr. A127 (m ²)	Price gr. A148 (m ²)
sand-grey <input type="checkbox"/>	410-2039	610-2039	810-2039		812-2039 ¹ NEW	
	Price gr. A199 (m ²)	Price gr. A175 (m ²)	Price gr. A136 (m ²)		Price gr. A148 (m ²)	
dark sand-grey <input type="checkbox"/>	410-2040	610-2040	810-2040		812-2040 ¹ NEW	
	Price gr. A199 (m ²)	Price gr. A175 (m ²)	Price gr. A136 (m ²)		Price gr. A148 (m ²)	
medium brown <input type="checkbox"/>	410-2041	610-2041	810-2041		812-2041 ¹ NEW	
	Price gr. A238 (m ²)	Price gr. A211 (m ²)	Price gr. A175 (m ²)		Price gr. A148 (m ²)	
medium grey <input type="checkbox"/>	410-2042	610-2042	810-2042	811-2042	812-2042	813-2042
medium	Price gr. A238 (m ²)	Price gr. A211 (m ²)	Price gr. A175 (m ²)	Price gr. A181 (m ²)	Price gr. A154 (m ²)	Price gr. A175 (m ²)
sand beige <input type="checkbox"/>	410-2043	610-2043	810-2043		812-2043 ¹ NEW	
	Price gr. A238 (m ²)	Price gr. A211 (m ²)	Price gr. A175 (m ²)		Price gr. A160 (m ²)	

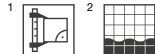

³ Upon request, defined color gradients and mosaic pictures can also be supplied.

Floor Tiles

20 x 20 cm



30 x 60 cm¹

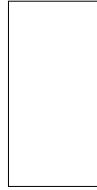

Cove Skirting^{3/4}

10 x 10 cm



Shower Tub System²

10 x 10 cm



10 x 10 cm



		20 x 20 / 8 x 8	30 x 60 / 12 x 24	10 x 10 / 4 x 4	10 x 10 / 4 x 4	10 x 10 / 4 x 4	
		197 x 197 x 6.5 mm	297 x 597 x 6 mm	100 x 97 x 6.5 mm	100 x 97 x 6.5 mm	97 x 97 x 6.5 mm	Nom. dim. - cm/in
		smooth, matt	smooth, matt	smooth, matt	smooth, matt	smooth, matt	Work size
		25.000/m ²	5.556/m ²	10.000/m	10.000/m		Surface
		13.875/m ²	13.273/m ²	1.500/m	1.700/m	0.170/piece	m ² /m - pieces
		25	10	40	16	4	m ² /m ² - kg
		1.000 m ²	1.800/m ²	4.000 m	1.600 m		Bundle - pieces
		13.875	23.890	6.000	2.720	0.680	Bundle - m ² /m
		72.000	71.994				Bundle - kg
		999.000	955.600				Pallet - m ²
		Bla	Bla	Bla	Bla	Bla	Pallet - kg
		R10/B	R10/B	R10/B	R10/B	R10/B	Product standard
		1	1				Slip resistance
		815-2113	806-2113	864-2113	885-2113	886-2113	Stress group
		Price gr. A115 (m ²)	Price gr. A121 (m ²)	Price gr. A419 (pce.)	Price gr. A445 (pce.)	Price gr. A475 (pce.)	neutral 3
		815-2111	806-2111	864-2111	885-2111	886-2111	(asphalt black) <input type="checkbox"/> VO
		Price gr. A115 (m ²)	Price gr. A121 (m ²)	Price gr. A419 (pce.)	Price gr. A445 (pce.)	Price gr. A475 (pce.)	neutral 1
		815-2008		864-2008	885-2008	886-2008	(deep black) <input type="checkbox"/> VO
		Price gr. A148 (m ²)		Price gr. A419 (pce.)	Price gr. A445 (pce.)	Price gr. A475 (pce.)	dark blue <input type="checkbox"/> VO
		815-2016 ¹ NEW		864-2016			dark green <input type="checkbox"/> VO
		Price gr. A160 (m ²)		Price gr. A419 (pce.)			dark green <input type="checkbox"/> VO
		815-2023		864-2023	885-2023	886-2023	medium ochre <input type="checkbox"/> VO
		Price gr. A148 (m ²)		Price gr. A419 (pce.)	Price gr. A445 (pce.)	Price gr. A475 (pce.)	medium ochre <input type="checkbox"/> VO
		815-2033 ¹ NEW		864-2033			active stone grey <input type="checkbox"/> VO
		Price gr. A160 (m ²)		Price gr. A419 (pce.)			active stone grey <input type="checkbox"/> VO
		815-2038	806-2038	864-2038	885-2038	886-2038	sand-white <input type="checkbox"/> VO
		Price gr. A115 (m ²)	Price gr. A121 (m ²)	Price gr. A419 (pce.)	Price gr. A445 (pce.)	Price gr. A475 (pce.)	sand-white <input type="checkbox"/> VO
		815-2039		864-2039	885-2039	886-2039	medium <input type="checkbox"/> VO
		Price gr. A115 (m ²)		Price gr. A419 (pce.)	Price gr. A445 (pce.)	Price gr. A475 (pce.)	medium <input type="checkbox"/> VO
		815-2040		864-2040	885-2040	886-2040	sand-grey <input type="checkbox"/> VO
		Price gr. A115 (m ²)		Price gr. A419 (pce.)	Price gr. A445 (pce.)	Price gr. A475 (pce.)	sand-grey <input type="checkbox"/> VO
		815-2041		864-2041	885-2041	886-2041	dark sand-grey <input type="checkbox"/> VO
		Price gr. A148 (m ²)		Price gr. A419 (pce.)	Price gr. A445 (pce.)	Price gr. A475 (pce.)	dark sand-grey <input type="checkbox"/> VO
		815-2042	806-2042	864-2042	885-2042	886-2042	medium brown <input type="checkbox"/> VO
		Price gr. A148 (m ²)	Price gr. A121 (m ²)	Price gr. A419 (pce.)	Price gr. A445 (pce.)	Price gr. A475 (pce.)	medium brown <input type="checkbox"/> VO
		815-2043		864-2043	885-2043	886-2043	medium grey <input type="checkbox"/> VO
		Price gr. A148 (m ²)		Price gr. A419 (pce.)	Price gr. A445 (pce.)	Price gr. A475 (pce.)	medium grey <input type="checkbox"/> VO
							medium <input type="checkbox"/> VO
							sand beige <input type="checkbox"/> VO



¹ For details, refer to page 534

² For details, refer to page 536

³ For details, refer to page 536

⁴ Color deviations compared to the adjoining covering due to production are no reason for complaint in case of horizontal laying.







Natural and lively

Besides its natural look, Quarzit is impressive because of a surface vividly nuanced by unusual gloss and mica spots in an authentic stone look. In addition to the aesthetic advantages, there are also practical ones: pleasant haptics is combined with high slip resistance and enormous wear resistance.

Studio photo / Architect: VSBL, Belgrade, Serbia / Photo: Jochen Stüber



basalt-grey



quarz-grey



sand-beige



sepia-brown



white-grey



Floor tile 12.5 x 12.5 cm, 5 x 5 in structured, R11/B



Floor tile 12.5 x 25 cm, 5 x 10 in structured, R11/B



Grid profile tile 12.5 x 25 cm, 5 x 10 in relief, R11/C



Floor tile 15 x 15 cm, 6 x 6 in structured, R11/C



Floor tile 25 x 25 cm, 10 x 10 in structured, R10/A,
Floor tile 25 x 25 cm, 10 x 10 in structured, R11/B

Mosaic 5 x 5 cm, 2 x 2 in



Mosaic sheet 30 x 30 cm, 12 x 12 in structured, R11/B



Floor tile 25 x 50 cm, 10 x 20 in, structured, R10/A
Floor tile 25 x 50 cm, 10 x 20 in, structured, R11/B



Floor tile 30 x 60 cm, 12 x 24 in, structured, R10/A
Floor tile 30 x 60 cm, 12 x 24 in, structured, R11/B

Mosaic: glass fibre net on reverse side, sheet: 297 x 297 mm



Floor tile 60 x 60 cm, 24 x 24 in, structured, R10/A
Patio tile 60 x 60 cm, 24 x 24 in, structured, R11/B



Stair tile with bevel 31 x 145 cm, 12 13/64 x 57 in, structured, R10/A



Riser 28 x 145 cm, 11 x 57 in, structured, R10/A



basalt-grey



quarz-grey



sand-beige



sepia-brown



white-grey



Letter tile 25 x 50 cm, 10 x 20 in, structured, R11/B



Skirting, cut 6 x 50 cm, 2 3/8 x 20 in, structured

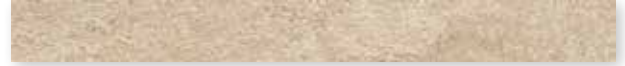

Skirting, cut 6 x 60 cm, 2 3/8 x 24 in, structured



Cove skirting decorated 10 x 60 cm, 4 x 24 in, structured, R10/A



Grooved tile 50 x 25 cm, 20 x 10 in, grooved, R11/C



Grooved tile 25 x 25 cm, 10 x 10 in grooved, R11/C



Grooved tile 12.5 x 25 cm, 5 x 10 in, grooved, R11/C



Grid profile tile
25 x 50 cm, 10 x 20 in,
relief, R11/C

Gutter tile
(trough depth 5 mm)



Gutter tile
50 x 25 cm, 20 x 10 in, structured, R11/B

without illustration: Gutter tile with outlet,
mitred pair, terminal piece

Ceramic channel cover
50 x 25 cm, 20 x 10 in,
structured



Ceramic channel cover
corner solution 30 x 30 cm, 12 x 12 in, structured



For details about Gutter tiles and the Ceramic channel cover, refer to the Pool + Spa programme of delivery.

Floor Tiles - joint 3 mm

5 x 5 cm^{1/4}



15 x 15 cm



25 x 25 cm¹



25 x 25 cm¹



25 x 50 cm¹



25 x 50 cm¹



25 x 50 cm^{1/2}



Sheet: 297 x 297 mm

7161H	342030H	332050HK	332050HK	342550HK	342550HK	342580HK	Grid profile tile	Model number
5 x 5 / 2 x 2	15 x 15 / 6 x 6	25 x 25 / 10 x 10	25 x 25 / 10 x 10	25 x 50 / 10 x 20	25 x 50 / 10 x 20	25 x 50 / 10 x 20		Nom. dim. - cm/in
47 x 47 x 8 mm	147 x 147 x 8 mm	247 x 247 x 8 mm	247 x 247 x 8 mm	247 x 497 x 8 mm	247 x 497 x 8 mm	247 x 497 x 8 mm		Work size
structured, matt	structured, matt	structured, matt	structured, matt	structured, matt	structured, matt	relief, matt		Surface
11.111	44.444	16.000	16.000	8.000	8.000	8.000		m ² - pieces
16.389	17.555	16.960	16.960	17.040	17.040	17.040		m ² - kg
14	35	14	14	9	9	9		Bundle - pieces
1.260	0.788	0.875	0.875	1.125	1.125	1.125		Bundle - m ²
20.650	13.825	14.840	14.840	19.170	19.170	19.170		Bundle - kg
37.800	63.001	70.875	70.875	40.500	40.500	40.500		Pallet - m ²
619.500	1,106.000	1,202.040	1,202.040	690.120	690.120	690.120		Pallet - kg
Ala	Bla	Ala	Ala	Ala	Ala	Ala		Product standard
R11/B	R11/C	R10/A	R11/B	R10/A	R11/B	R11/C		Slip resistance
2	2	2	2	2	2	2		Stress group
8460-7161H	8460-342030H	8450-332050HK	8460-332050HK	8450-342550HK	8460-342550HK	8460-342580HK		basalt grey <input type="checkbox"/> V4
Price gr. A289 (m ²)	Price gr. A157 (m ²)	Price gr. A148 (m ²)	Price gr. A157 (m ²)	Price gr. A157 (m ²)	Price gr. A166 (m ²)	Price gr. A181 (m ²)		
8461-7161H	8461-342030H	8451-332050HK	8461-332050HK	8451-342550HK	8461-342550HK	8461-342580HK		quartz-grey <input type="checkbox"/> V4
Price gr. A289 (m ²)	Price gr. A157 (m ²)	Price gr. A148 (m ²)	Price gr. A157 (m ²)	Price gr. A157 (m ²)	Price gr. A166 (m ²)	Price gr. A181 (m ²)		
8462-7161H	8462-342030H	8452-332050HK	8462-332050HK	8452-342550HK	8462-342550HK	8462-342580HK		sand-beige <input type="checkbox"/> V4
Price gr. A289 (m ²)	Price gr. A157 (m ²)	Price gr. A148 (m ²)	Price gr. A157 (m ²)	Price gr. A157 (m ²)	Price gr. A166 (m ²)	Price gr. A181 (m ²)		
8463-7161H	8463-342030H	8453-332050HK	8463-332050HK	8453-342550HK	8463-342550HK	8463-342580HK		sepia-brown <input type="checkbox"/> V4
Price gr. A289 (m ²)	Price gr. A157 (m ²)	Price gr. A148 (m ²)	Price gr. A157 (m ²)	Price gr. A157 (m ²)	Price gr. A166 (m ²)	Price gr. A181 (m ²)		
8464-7161H	8464-342030H	8454-332050HK	8464-332050HK	8454-342550HK	8464-342550HK	8464-342580HK		white grey <input type="checkbox"/> V4
Price gr. A289 (m ²)	Price gr. A157 (m ²)	Price gr. A148 (m ²)	Price gr. A157 (m ²)	Price gr. A157 (m ²)	Price gr. A166 (m ²)	Price gr. A181 (m ²)		



Floor Tiles - joint 3 mm¹

30 x 60 cm



30 x 60 cm



60 x 60 cm



12.5 x 12.5 cm³



12.5 x 25 cm



12.5 x 25 cm²



Grid profile tile

B200HK	B200HK	B600HK		32020H	38110H	34090H	Model number
30 x 60 / 12 x 24	30 x 60 / 12 x 24	60 x 60 / 24 x 24		12.5 x 12.5 / 5 x 5	12.5 x 25 / 5 x 10	12.5 x 25 / 5 x 10	Nom. dim. - cm/in
297 x 597 x 8 mm	297 x 597 x 8 mm	597 x 597 x 8 mm		119 x 119 x 8 mm	119 x 244 x 8 mm	119 x 244 x 8 mm	Work size
structured, matt	structured, matt	structured, matt		structured, matt	structured, matt	relief, matt	Surface
5.556	5.556	2.778		64.000	32.000	32.000	m ² - pieces
17.413	17.413	18.001		15.360	15.680	15.360	m ² - kg
6	6	4		66	33	33	Bundle - pieces
1.080	1.080	1.440		1.031	1.031	1.031	Bundle - m ²
18.804	18.804	25.920		15.840	16.170	15.840	Bundle - kg
43.197	43.197	43.197		86.625	86.625	86.625	Pallet - m ²
752.160	752.160	777.600		1,330.560	1,358.280	1,330.560	Pallet - kg
Ala	Ala	Ala		Ala	Ala	Ala	Product standard
R10/A	R11/B	R10/A		R11/B	R11/B	R11/C	Slip resistance
2	2	2		2	2	2	Stress group
8450-B200HK	8460-B200HK	8450-B600HK		8460-32020H	8460-38110H	8460-34090H	basalt grey <input type="checkbox"/> V4
Price gr. A124 (m ²)	Price gr. A142 (m ²)	Price gr. A136 (m ²)		Price gr. A157 (m ²)	Price gr. A127 (m ²)	Price gr. A148 (m ²)	
8451-B200HK	8461-B200HK	8451-B600HK		8461-32020H	8461-38110H	8461-34090H	quartz-grey <input type="checkbox"/> V4
Price gr. A124 (m ²)	Price gr. A142 (m ²)	Price gr. A136 (m ²)		Price gr. A157 (m ²)	Price gr. A127 (m ²)	Price gr. A148 (m ²)	
8452-B200HK	8462-B200HK	8452-B600HK		8462-32020H	8462-38110H	8462-34090H	sand-beige <input type="checkbox"/> V4
Price gr. A124 (m ²)	Price gr. A142 (m ²)	Price gr. A136 (m ²)		Price gr. A157 (m ²)	Price gr. A127 (m ²)	Price gr. A148 (m ²)	
8453-B200HK	8463-B200HK	8453-B600HK		8463-32020H	8463-38110H	8463-34090H	sepia-brown <input type="checkbox"/> V4
Price gr. A124 (m ²)	Price gr. A142 (m ²)	Price gr. A136 (m ²)		Price gr. A157 (m ²)	Price gr. A127 (m ²)	Price gr. A148 (m ²)	
8454-B200HK	8464-B200HK	8454-B600HK		8464-32020H	8464-38110H	8464-34090H	white grey <input type="checkbox"/> V4
Price gr. A124 (m ²)	Price gr. A142 (m ²)	Price gr. A136 (m ²)		Price gr. A157 (m ²)	Price gr. A127 (m ²)	Price gr. A148 (m ²)	



¹ ² ³ Supplied as double-tiles; to be broken by customer
⁴ Glass fibre net on reverse side

Stair Tile with Bevel^{2/3/5}

31 x 145 cm



Riser^{2/3/5}

28 x 145 cm

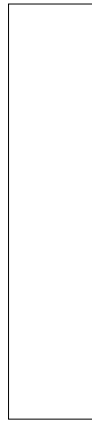

Skirting, cut¹

6 x 50 cm



6 x 60 cm



Cove Skirting, decorated^{1/2/6/10}

10 x 60 cm



Letter Tile
1/2/4

25 x 50 cm

WT. 1.35m



Model number	B773HK	B774HK	342557HK	B611HK	B612HK		342555HK
Nom. dim. - cm/in	31 x 145 / 12 3/8 x 58	28 x 145 / 11 3/16 x 58	6 x 50 / 2 3/8 x 20	6 x 60 / 2 3/8 x 24	10 x 60 / 4 x 24		25 x 50 / 10 x 20
Work size	307 x 1447 x 10.5 mm	280 x 1447 x 10.5 mm	60 x 497 x 8 mm	60 x 597 x 8 mm	100 x 597/35 x 9 mm		247 x 497 x 8 mm
Surface	structured, matt	structured, matt	structured, matt	structured, matt	structured, matt		structured, matt
m - pieces	0.690	0.690	2.000	1.667	1.667		2
m/pce. - kg	7.480/m	6.716/m	1.098/m	1.100/m	2.000/m		2.130/piece
Bundle - pieces	2	2	30	34	20		
Bundle - m	2.899	2.899	15.000	20.396	11.998		
Bundle - kg	21.682	19.466	16.470	22.440	24.000		
Pallet - m							
Pallet - kg							
Product standard	Ala	Ala	Ala	Ala	Alb		Ala
Slip resistance	R10/A	R10/A			R10/A		R11/B
Stress group	2	2					2
	8450-B773HK Price gr. A560 (pce.)	8450-B774HK Price gr. A528 (pce.)	8450-342557HK Price gr. A434 (pce.)	8450-B611HK Price gr. A434 (pce.)	8450-B612HK⁷ Price gr. A445 (pce.)		900725-342555HK Price gr. A668 (pce.)
basalt grey	8451-B773HK Price gr. A560 (pce.)	8451-B774HK Price gr. A528 (pce.)	8451-342557HK Price gr. A434 (pce.)	8451-B611HK Price gr. A434 (pce.)	8451-B612HK⁸ Price gr. A445 (pce.)		900726-342555HK Price gr. A668 (pce.)
quartz-grey	8452-B773HK Price gr. A560 (pce.)	8452-B774HK Price gr. A528 (pce.)	8452-342557HK Price gr. A434 (pce.)	8452-B611HK Price gr. A434 (pce.)	8452-B612HK⁸ Price gr. A445 (pce.)		900713-342555HK Price gr. A668 (pce.)
sand-beige	8453-B773HK Price gr. A560 (pce.)	8453-B774HK Price gr. A528 (pce.)	8453-342557HK Price gr. A434 (pce.)	8453-B611HK Price gr. A434 (pce.)	8453-B612HK⁸ Price gr. A445 (pce.)		900714-342555HK Price gr. A668 (pce.)
sepia-brown	8454-B773HK Price gr. A560 (pce.)	8454-B774HK Price gr. A528 (pce.)	8454-342557HK Price gr. A434 (pce.)	8454-B611HK Price gr. A434 (pce.)	8454-B612HK⁹ Price gr. A445 (pce.)		900719-342555HK Price gr. A668 (pce.)
white grey							

Type height 7 cm

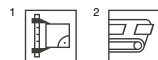

³ Rectified only on the two short sides. The long side can not be rectified.

⁴ Only figures/letters can be realized.

Color combination:

Base color: basalt-grey, quartz-grey, sand-beige, sepia-brown,
color of letters: active white / neutral 10.

⁵ For details, refer to page 538. For more solutions concerning stair design, refer to the series Area Pro.

⁶ For detailed drawings of cove skirting, see page 536

⁷ Stress group: 2

⁸ Stress group: 3

⁹ Stress group: 4

¹⁰ Color deviations compared to the adjoining covering due to production are no reason for complaint in case of horizontal laying.

Patio Tiles^{1/4}

60 x 60 cm

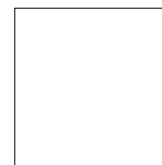

						61061HK	Model number
						60 x 60 / 24 x 24	Nom. dim. - cm/in
						597 x 597 x 20 mm	Work size - mm
						structured, matt	Surface
						2.778	m² - pieces
						43.059	m² - kg
						1	Bundle - pieces
						0.360	Bundle - m ²
						15.500	Bundle - kg
						17.279	Pallet - m ²
						744.000	Pallet - kg
						Alla	Product standard
						R11/B	Slip resistance
						3	Stress group
						8460-61061HK	4
						Price gr. A220 (m ²)	basalt grey <input type="checkbox"/> V4
						8461-61061HK	4
						Price gr. A220 (m ²)	quartz-grey <input type="checkbox"/> V4
						8462-61061HK	4
						Price gr. A220 (m ²)	sand-beige <input type="checkbox"/> V4



Gutter Tiles^{2/3/6}
(trough depth 5 mm)

50 x 25 cm



50 x 25 cm⁵

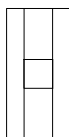

50 x 25 cm

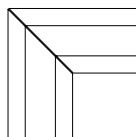

50 x 25 cm⁵

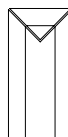

50 x 25 cm

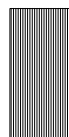

25 x 25 cm



12.5 x 25 cm



Gutter tile	Gutter tile with outlet 110 / 110 mm	Gutter tile, mitred pair	Gutter tile, terminal piece					
53320	53321	53322	53323	53151	53150	53159	Model number	
50 x 25 / 20 x 10	50 x 25 / 20 x 10			50 x 25 / 20 x 10	25 x 25 / 10 x 10	12.5 x 25 / 5 x 10	Nom. dim. - cm/in	
494 x 244 x 14	494 x 244 x 14	(2x) 490 x 244 x 14	494 x 244 x 14	494 x 244 x 12.5	244 x 244 x 12.5	119 x 244 x 12.5	Work size - mm	
structured, matt	structured, matt	structured, matt	structured, matt	grooved, matt	grooved, matt	grooved, matt	Surface	
2.000				2.000	4.000	8.000	m - pieces	
2.500/piece	2.300/piece	3.800/pair	2.500/piece	3.550/piece	1.775/piece	0.888/piece	Pce./pair - kg	
5 piece	5 piece	2 pair	5 piece	6 piece	9 piece	21 piece	Bundle - pce./pair	
2.500				3.000	2.250	2.625	Bundle - m	
12.500	11.500	7.600	12.500	21.300	15.975	18.648	Bundle - kg	
							Pallet - m	
							Pallet - kg	
							Product standard	
							Slip resistance	
Ala	Ala	Ala	Ala	Ala	Ala	Ala		
R11/B	R11/B	R11/B	R11/B	R11/C	R11/C	R11/C		
8460-53320H	8460-53321H	8460-53322H	8460-53323H	8460-53151	8460-53150	8460-53159	basalt grey <input type="checkbox"/> V4	
Price gr. A519 (pce.)	Price gr. A593 (pce.)	Price gr. A645 (pair)	Price gr. A593 (pce.)	Price gr. A560 (pce.)	Price gr. A480 (pce.)	Price gr. A430 (pce.)		
8461-53320H	8461-53321H	8461-53322H	8461-53323H	8461-53151	8461-53150	8461-53159	quartz-grey <input type="checkbox"/> V4	
Price gr. A519 (pce.)	Price gr. A593 (pce.)	Price gr. A645 (pair)	Price gr. A593 (pce.)	Price gr. A560 (pce.)	Price gr. A480 (pce.)	Price gr. A430 (pce.)		
8462-53320H	8462-53321H	8462-53322H	8462-53323H	8462-53151	8462-53150	8462-53159	sand-beige <input type="checkbox"/> V4	
Price gr. A519 (pce.)	Price gr. A593 (pce.)	Price gr. A645 (pair)	Price gr. A593 (pce.)	Price gr. A560 (pce.)	Price gr. A480 (pce.)	Price gr. A430 (pce.)		
8463-53320H	8463-53321H	8463-53322H	8463-53323H	8463-53151	8463-53150	8463-53159	sepia-brown <input type="checkbox"/> V4	
Price gr. A519 (pce.)	Price gr. A593 (pce.)	Price gr. A645 (pair)	Price gr. A593 (pce.)	Price gr. A560 (pce.)	Price gr. A480 (pce.)	Price gr. A430 (pce.)		
8464-53320H	8464-53321H	8464-53322H	8464-53323H	8464-53151	8464-53150	8464-53159	white grey <input type="checkbox"/> V4	
Price gr. A519 (pce.)	Price gr. A593 (pce.)	Price gr. A645 (pair)	Price gr. A593 (pce.)	Price gr. A560 (pce.)	Price gr. A480 (pce.)	Price gr. A430 (pce.)		



³ On request, also available in a length of 497 mm.

⁴ High weight only to carry with two persons.

⁵ Minimum order quantity: 10 pieces. In case of smaller quantities, the price must be individually calculated.

⁶ Short edge rectified

Further details on gutter tiles and grooved tiles in the Pool+Spa delivery programme.





Elegant and timeless

Structures and colors of various rocks from the Italian coastal region of "Cinque Terre" merge in the Savona floor tile series to create a lively composition of coarsegrained texture and soft layers. A finely dosed granulate application gives the surface a pleasantly stony look and haptics. Mica-like glossy spots underline the natural effect.

Studio photo / Architect: VSBL, Belgrad, Serbia / Photo: Jochen Stüber



lime



beige



brown



grey



anthracite



Floor tile 15 x 15 cm, 6 x 6 in
structured, R11/C



Floor tile 30 x 60 cm, 12 x 24 in, structured, R10/A
Floor tile 30 x 60 cm, 12 x 24 in, structured, R11/B



Floor tile 60 x 60 cm, 24 x 24 in, structured, R10/A
Floor tile 60 x 60 cm, 24 x 24 in, structured, R11/B



Skirting, cut 6 x 60 cm, 2 3/8 x 24 in, structured

Mosaic 5 x 5 cm, 2 x 2 in



Mosaic sheet 30 x 30 cm, 12 x 12 in
structured, R11/B

Mosaic: glass fibre net on reverse side,
sheet: 297 x 297 mm



Floor tile 60 x 120 cm, 24 x 48 in, structured, R10/A

Mosaic^{1/2}

Floor Tiles

5 x 5 cm



15 x 15 cm



30 x 60 cm¹

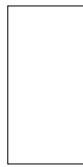

30 x 60 cm¹



60 x 60 cm¹

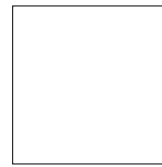

60 x 60 cm¹

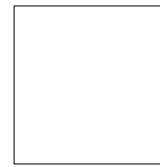

60 x 120 cm^{1/3}

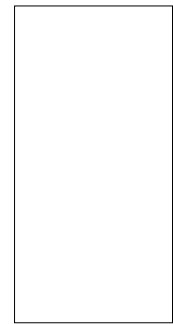

Sheet: 297 x 297 mm

Model number	7161H	342030H	B200HK	B200HK	B600HK	B600HK	B670HK
Nom. dim. - cm/in	5 x 5 / 2 x 2	15 x 15 / 6 x 6	30 x 60 / 12 x 24	30 x 60 / 12 x 24	60 x 60 / 24 x 24	60 x 60 / 24 x 24	60 x 120 / 24 x 48
Work size	47 x 47 x 8 mm	147 x 147 x 8 mm	297 x 597 x 8 mm	297 x 597 x 8 mm	597 x 597 x 8 mm	597 x 597 x 8 mm	597 x 1197 x 8 mm
Surface	structured, matt	structured, matt	structured, matt	structured, matt	structured, matt	structured, matt	structured, matt
m ² - pieces	11.111	44.444	5.556	5.556	2.778	2.778	1.388
m ² - kg	16.389	17.555	17.413	17.413	18.001	18.001	17.489
Bundle - pieces	14	35	6	6	4	4	2
Bundle - m ²	1.260	0.788	1.080	1.080	1.440	1.440	1.441
Bundle - kg	20.650	13.825	18.804	18.804	25.920	25.920	25.200
Pallet - m ²	37.800	63.001	43.197	43.197	43.197	43.197	36.023
Pallet - kg	619.500	1,106.000	752.160	752.160	777.600	777.600	630.000
Product standard	Ala	Bla	Ala	Ala	Ala	Ala	Ala
Slip resistance	R11/B	R11/C	R10/A	R11/B	R10/A	R11/B	R10/A
Stress group	2	2	2	2	2	2	2
lime	8810-7161H Price gr. A289 (m ²)	8810-342030H Price gr. A157 (m ²)	8800-B200HK Price gr. A124 (m ²)	8810-B200HK Price gr. A142 (m ²)	8800-B600HK Price gr. A136 (m ²)	8810-B600HK Price gr. A151 (m ²)	8800-B670HK Price gr. A166 (m ²)
beige	8811-7161H Price gr. A289 (m ²)	8811-342030H Price gr. A157 (m ²)	8801-B200HK Price gr. A124 (m ²)	8811-B200HK Price gr. A142 (m ²)	8801-B600HK Price gr. A136 (m ²)	8811-B600HK Price gr. A151 (m ²)	8801-B670HK Price gr. A166 (m ²)
brown	8812-7161H Price gr. A289 (m ²)	8812-342030H Price gr. A157 (m ²)	8802-B200HK Price gr. A124 (m ²)	8812-B200HK Price gr. A142 (m ²)	8802-B600HK Price gr. A136 (m ²)	8812-B600HK Price gr. A151 (m ²)	8802-B670HK Price gr. A166 (m ²)
grey	8813-7161H Price gr. A289 (m ²)	8813-342030H Price gr. A157 (m ²)	8803-B200HK Price gr. A124 (m ²)	8813-B200HK Price gr. A142 (m ²)	8803-B600HK Price gr. A136 (m ²)	8813-B600HK Price gr. A151 (m ²)	8803-B670HK Price gr. A166 (m ²)
anthracite	8814-7161H Price gr. A289 (m ²)	8814-342030H Price gr. A157 (m ²)	8804-B200HK Price gr. A124 (m ²)	8814-B200HK Price gr. A142 (m ²)	8804-B600HK Price gr. A136 (m ²)	8814-B600HK Price gr. A151 (m ²)	8804-B670HK Price gr. A166 (m ²)



Skirting, cut¹

6 x 60 cm



Model number	B611HK						
Nom. dim. - cm/in	6 x 60 / 2 3/8 x 24						
Work size	60 x 597 x 8 mm						
Surface	structured, matt						
m - pieces	1.667						
m - kg	1.100						
Bundle - pieces	34						
Bundle - m	20.396						
Bundle - kg	22.440						
Pallet - m							
Pallet - kg							
Product standard	Ala						
lime	8800-B611HK Price gr. A434 (pce.)						
beige	8801-B611HK Price gr. A434 (pce.)						
brown	8802-B611HK Price gr. A434 (pce.)						
grey	8803-B611HK Price gr. A434 (pce.)						
anthracite	8804-B611HK Price gr. A434 (pce.)						



¹ Glass fibre net on reverse side
³ High weight only to carry with two persons.

Studio photo / Architect: VSBL, Belgrade, Serbia / Photo: Jochen Stüber







Zeitgeist meets timeless

The Senja Pure ceramic tile series gives bathrooms and private wellness areas a cosy touch and a warm, lively impression. Its natural colors and finely structured surfaces are trendy and at the same time timelessly beautiful. The result: rooms harmoniously matched to one another in clear vintage style, in pleasantly restrained Nordic Design or in Shabby-Chic-Style. The successful collection was extended to include the strong color Shabby-Chic-Brown and large-size natural-white wall tiles – thus offering even more scope for design.

Rendering

Mosaic 2.5 x 2.5 cm, 1 x 1 in



Mosaic sheet 30 x 30 cm, 12 x 12 in maple, structured,
Mosaic sheet 30 x 30 cm, 12 x 12 in maple, structured, R10/B

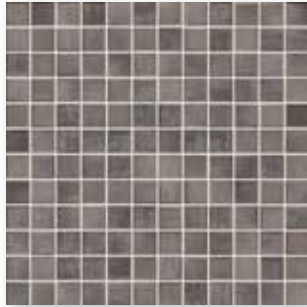

Mosaic sheet 30 x 30 cm, 12 x 12 in shabby chic brown, structured,
Mosaic sheet 30 x 30 cm, 12 x 12 in shabby chic brown, structured, R10/B



Mosaic sheet 30 x 30 cm, 12 x 12 in wenge-metallic, structured

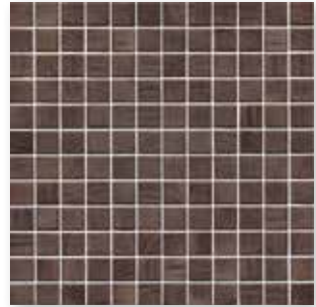

Mosaic sheet 30 x 30 cm, 12 x 12 in wenge, structured,
Mosaic sheet 30 x 30 cm, 12 x 12 in wenge, structured, R10/B

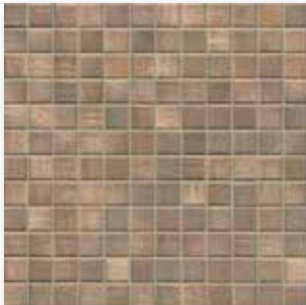

Mosaic sheet 30 x 30 cm, 12 x 12 in oak, structured,
Mosaic sheet 30 x 30 cm, 12 x 12 in oak, structured, R10/B



Mosaic sheet 30 x 30 cm, 12 x 12 in shabby chic, structured,
Mosaic sheet 30 x 30 cm, 12 x 12 in shabby chic, structured, R10/B



Mosaic sheet 30 x 30 cm, 12 x 12 in wood-mix, structured



Mosaic sheet 30 x 30 cm, 12 x 12 in wood-mix metallic, structured



Mosaics glued thermoplastically on back can be used not only in dry zones but also without any problems in underwater areas (e.g. swimming pools/whirlpools) as well as in permanently wet areas.

Mosaic 5 x 5 cm, 2 x 2 in



Mosaic sheet 30 x 30 cm, 12 x 12 in maple, structured, R10/B



Mosaic sheet 30 x 30 cm, 12 x 12 in shabby chic brown, structured, R10/B



Mosaic sheet 30 x 30 cm, 12 x 12 in wenge, structured, R10/B



Mosaic sheet 30 x 30 cm, 12 x 12 in oak, structured, R10/B



Mosaic sheet 30 x 30 cm, 12 x 12 in shabby chic, structured, R10/B



Mosaics glued thermoplastically on back can be used not only in dry zones but also without any problems in underwater areas (e.g. swimming pools/whirlpools) as well as in permanently wet areas.

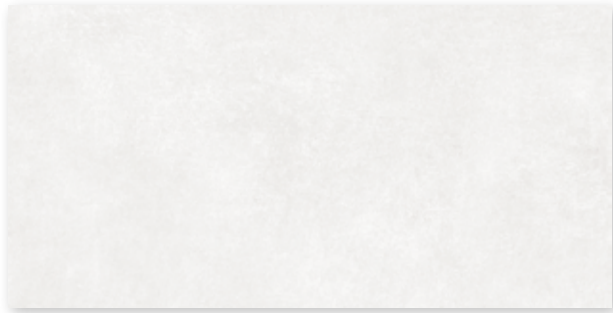

Wall tile 30 x 60 cm, 12 x 24 in, natural-white, smooth



Wall tile 30 x 90 cm, 12 x 36 in, natural-white, smooth

Wall Tiles⁴

30 x 60 cm

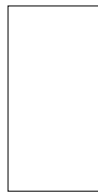

30 x 90 cm²

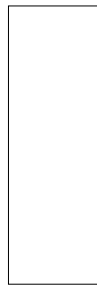

Mosaic¹

2.5 x 2.5 cm

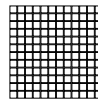

2.5 x 2.5 cm

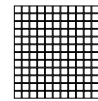

5 x 5 cm

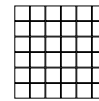

		30 x 60 / 12 x 24	30 x 90 / 12 x 36	2.5 x 2.5 / 1 x 1	2.5 x 2.5 / 1 x 1	5 x 5 / 2 x 2	
		297 x 597 x 6 mm	297 x 897 x 6 mm	23 x 23 x 6.5 mm	23 x 23 x 6.5 mm	47 x 47 x 6.5 mm	Nom. dim. - cm/in
		smooth, silky-matt	smooth, silky-matt	structured, matt	structured, matt	structured, matt	Work size
		5.556	3.704	11 sheets	11 sheets	11 sheets	Surface
		10.279	10.400	12.100	12.100	12.331	m ² - piece
		13	8	11 sheets	11 sheets	11 sheets	m ² - kg
		2.340	2.160	1.000	1.000	1.000	Bundle - piece
		24.050	22.464	12.100	12.100	12.331	Bundle - m ²
		112.311	51.836	48.000	48.000	64.000	Bundle - kg
		1,154.400	539.136	580.800	580.800	789.184	Pallet - m ²
		BIII	BIII	Blb	Blb	Blb	Pallet - kg
				R10/B	R10/B	R10/B	Product standard
				1	1	1	Slip resistance
		203331H	323332H				Stress group
		Price gr. W90 (m ²)	Price gr. W111 (m ²)				natural white <input type="checkbox"/> V1
				3221H	3201H	3251H	4
				Price gr. W288 (m ²)	Price gr. W303 (m ²)	Price gr. W240 (m ²)	maple <input type="checkbox"/> V2
				3222H	3206H	3252H	3
				Price gr. W288 (m ²)	Price gr. W303 (m ²)	Price gr. W240 (m ²)	shabby chic brown <input type="checkbox"/> V3
				3227^{3/5}			2
				Price gr. W323 (m ²)			wenge-metallic <input type="checkbox"/> V2
				3228H	3202H	3258H	2
				Price gr. W288 (m ²)	Price gr. W303 (m ²)	Price gr. W240 (m ²)	wenge <input type="checkbox"/> V2
				3303H	3203H	3353H	4
				Price gr. W288 (m ²)	Price gr. W303 (m ²)	Price gr. W240 (m ²)	oak <input type="checkbox"/> V2
				3304H	3314H	3354H	4
				Price gr. W288 (m ²)	Price gr. W303 (m ²)	Price gr. W240 (m ²)	shabby chic <input type="checkbox"/> V3
				3305H			4
				Price gr. W303 (m ²)			wood-mix <input type="checkbox"/> V4
				3306^{3/5}			1
				Price gr. W323 (m ²)			wood-mix metallic <input type="checkbox"/> V4



³ Not or only to a limited extent resistant to acids and alkalis.

⁴ Not frost-resistant

⁵ without Hytect coating





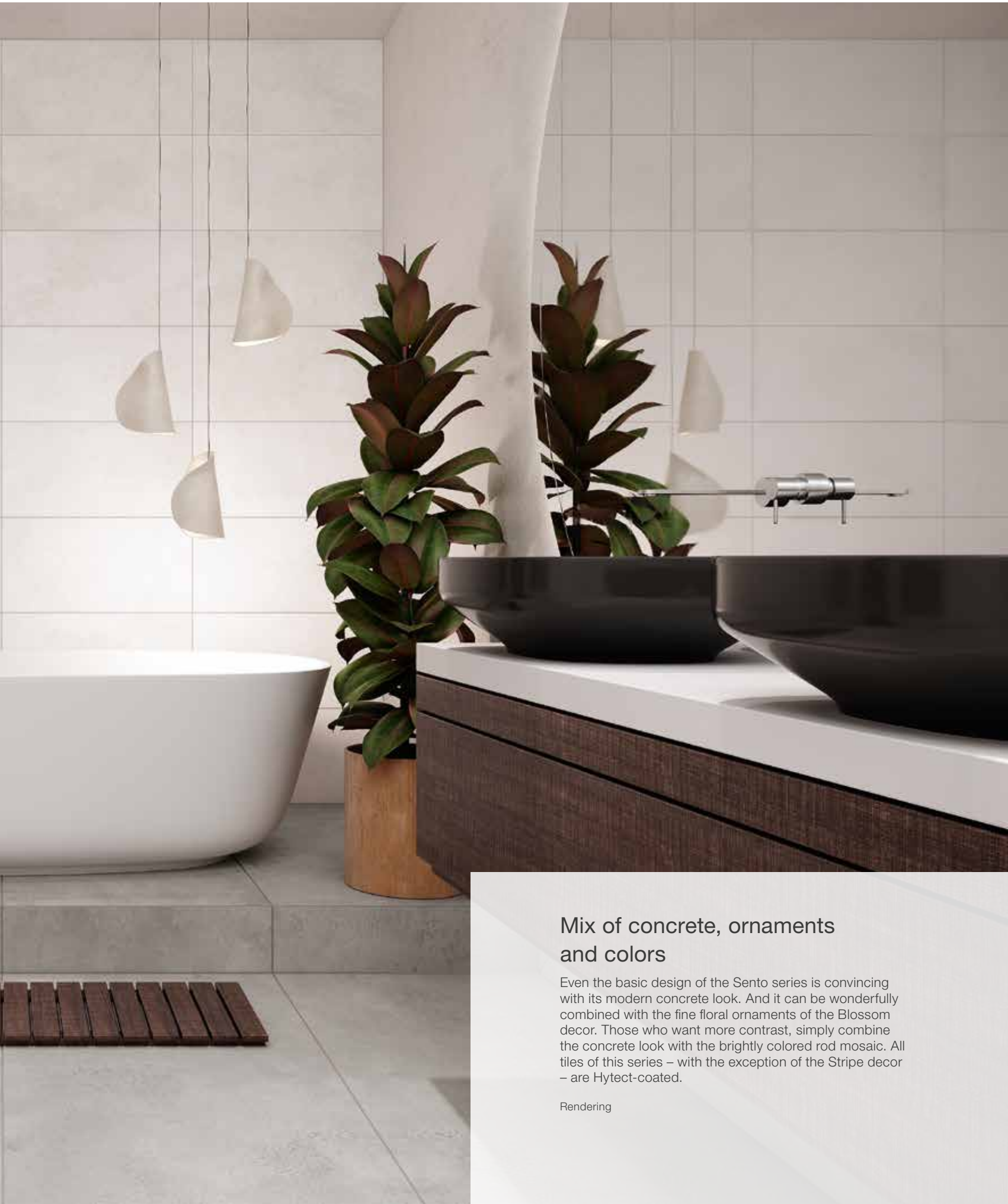

Mix of concrete, ornaments and colors

Even the basic design of the Sento series is convincing with its modern concrete look. And it can be wonderfully combined with the fine floral ornaments of the Blossom decor. Those who want more contrast, simply combine the concrete look with the brightly colored rod mosaic. All tiles of this series – with the exception of the Stripe decor – are Hytect-coated.

Rendering

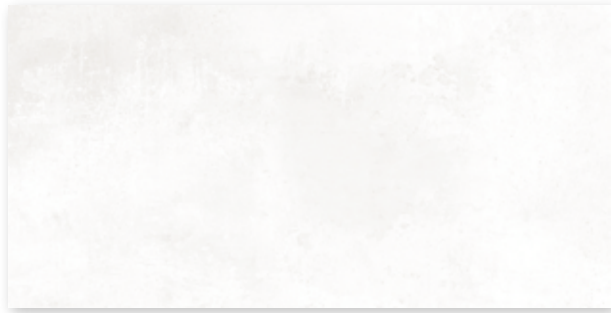

Wall tile 30 x 60 cm, 12 x 24 in, pale white, structured



Wall tile 35 x 100 cm, 14 x 40 in, pale white, structured

Decoration elements



Decorative tile Blossom 30 x 60 cm, 12 x 24 in, beige grey, structured

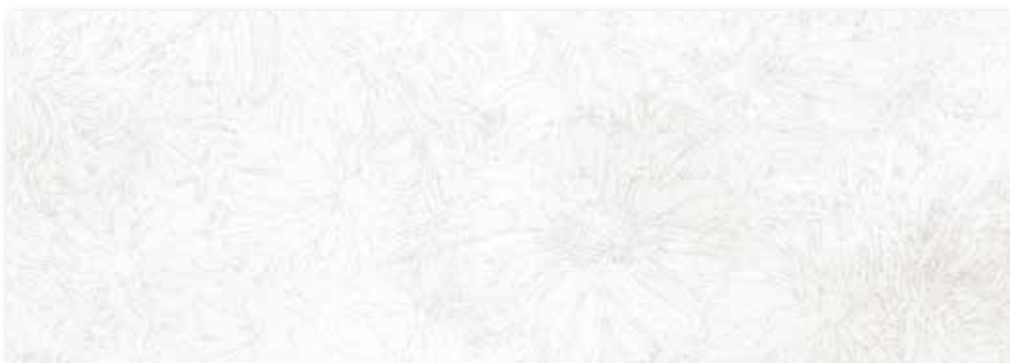

Decorative tile Blossom 35 x 100 cm, 14 x 40 in, beige grey, structured



Decoration elements



Cut decoration Color Stripe 30 x 30 cm,
12 x 12 in, sky aqua, structured

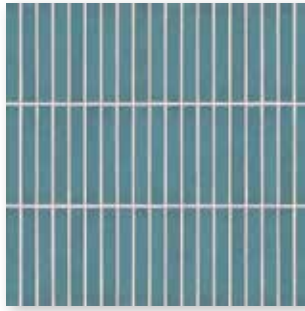

Cut decoration Color Stripe 30 x 30 cm,
12 x 12 in, pacific blue, structured



Cut decoration Color Stripe 30 x 30 cm,
12 x 12 in, lava black, structured

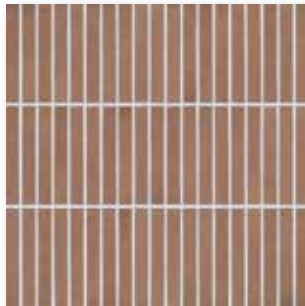

Cut decoration Color Stripe 30 x 30 cm,
12 x 12 in, earth red, structured

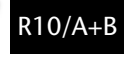
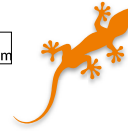

off white

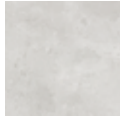

concrete grey



pale mud



dark anthracite



Floor tile 30 x 60 cm, 12 x 24 in, structured, R10/A+B



Floor tile 60 x 60 cm, 24 x 24 in, structured, R10/A+B



Floor tile 60 x 120 cm, 24 x 48 in, structured, R10/A+B



Skirting, cut 7 x 60 cm, 2 13/16 x 24 in, structured

Decoration elements



Floor decor Blossom 60 x 60 cm, 24 x 24 in, structured, R10/A+B

Mosaic 5 x 5 cm, 2 x 2 in



Mosaic sheet 30 x 30 cm, 12 x 12 in, off white, structured, R10/A+B



Mosaic sheet 30 x 30 cm, 12 x 12 in, concrete grey, structured, R10/A+B



Mosaic sheet 30 x 30 cm, 12 x 12 in, pale mud, structured, R10/A+B

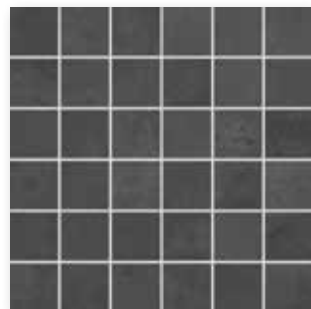

Mosaic sheet 30 x 30 cm, 12 x 12 in, dark anthracite, structured, R10/A+B

Mosaic: Glass fibre net on reverse side,
Sheet: 297 x 297 mm

Wall Tiles

Decoration Elements⁶

30 x 60 cm



35 x 100 cm¹

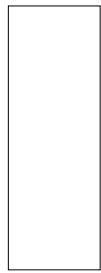

30 x 60 cm



35 x 100 cm¹



30 x 30 cm^{2/3/4/5}



			Decorative tile Blossom	Decorative tile Blossom	Cut decoration Color Stripe Sheet; 297 x 297 mm		
Nom. dim. - cm/in	30 x 60 / 12 x 24	35 x 100 cm / 14 x 40	30 x 60 / 12 x 24	35 x 100 cm / 14 x 40	30 x 30 / 12 x 12		
Work size	297 x 597 x 6 mm	347 x 997 x 6 mm	297 x 597 x 6 mm	347 x 997 x 6 mm	297 x 297 x 6.5 mm		
Surface	structured, stone-matt	structured, stone-matt	structured, stone-matt	structured, stone-matt	strukturiert, semi-matt		
m ² /m - pieces	5.556/m ²	2.857/m ²	5.556/m ²	2.857/m ²	3.333/m		
m ² /m - kg	10.279/m ²	10.108/m ²	10.279/m ²	10.108/m ²	3.326/m		
Bundle - pieces	13	5	13	5	5		
Bundle - m ² /m	2.340 m ²	1.750 m ²	2.340 m ²	1.750 m ²	1.500 m		
Bundle - kg	24.050	17.690	24.050	17.690	4.990		
Pallet - m ²	112.311	70.004	112.311	70.004			
Pallet - kg	1,154.400	707.600	1,154.400	707.600			
Product standard	BIII	BIII	BIII	BIII	Bla		
	203412H	363414H					
pale white	Price gr. C77 (m ²)	Price gr. C143 (m ²)					
			203413H	363415H			
beige grey			Price gr. C89 (m ²)	Price gr. C149 (m ²)			
					203408		
sky aqua					Price gr. C558 (pce.)		
					203409		
pacific blue					Price gr. C558 (pce.)		
					203410		
lava black					Price gr. C558 (pce.)		
					203411		
earth red					Price gr. C558 (pce.)		

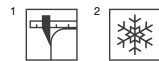

¹ Glass fibre net on reverse side
² Only suitable for laying on the wall.
³ without Hytect coating
⁴ Decoration elements only available in full boxes.

Mosaic^{1/2}

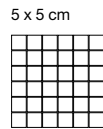

Floor Tiles¹

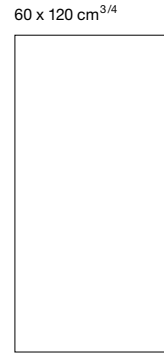
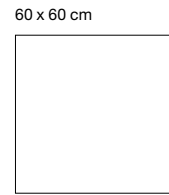

Decoration Elements^{1/5}

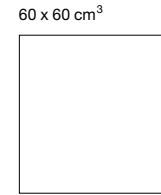

Skirting, cut¹

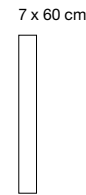

Sheet: 297 x 297 mm

Floor decor
Blossom



5 x 5 / 2 x 2	30 x 60 / 12 x 24	60 x 60 / 24 x 24	60 x 120 / 24 x 48	60 x 60 / 24 x 24	7 x 60 / 2 13/16 x 24	Nom. dim. - cm/in
47 x 47 x 6 mm	297 x 597 x 6 mm	597 x 597 x 6 mm	597 x 1197 x 6 mm	597 x 597 x 6 mm	70 x 597 x 6 mm	Work size
structured, matt	structured, matt	structured, matt	structured, matt	structured, matt	structured, matt	Surface
11.111 sheets/m ²	5.556/m ²	2.778/m ²	1.388/m ²	2.778/m ²	1.667/m	m ² /m - pieces
11.488 sheets/m ²	13.273/m ²	13.581/m ²	14.088/m ²	13.581/m ²	0.938/m	m ² /m - kg
11	10	5	3	5	38	Bundle - pieces
0.990 m ²	1.800 m ²	1.800 m ²	2.161 m ²	1.800 m ²	22.795 m	Bundle - m ² /m
11.374	23.890	24.445	30.450	24.445	21.394	Bundle - kg
35.640	71.994	64.795	75.648	64.795		Pallet - m ²
409.464	955.600	880.020	1.065.750	880.020		Pallet - kg
Bla	Bla	Bla	Bla	Bla	Bla	Product standard
R10/A+B	R10/A+B	R10/A+B	R10/A+B	R10/A+B		Slip resistance
1	1	1	1	1		Stress group
431601H	431605H	431609H	431613H		431621H	off white <input type="checkbox"/> V2
Price gr. C308 (m ²)	Price gr. C98 (m ²)	Price gr. C107 (m ²)	Price gr. C137 (m ²)		Price gr. C440 (pce.)	off white <input type="checkbox"/> V3
				431617H		concrete grey <input type="checkbox"/> V2
				Price gr. C116 (m ²)		concrete grey <input type="checkbox"/> V3
431602H	431606H	431610H	431614H		431622H	pale mud <input type="checkbox"/> V2
Price gr. C308 (m ²)	Price gr. C98 (m ²)	Price gr. C107 (m ²)	Price gr. C137 (m ²)		Price gr. C440 (pce.)	pale mud <input type="checkbox"/> V3
				431618H		dark anthracite <input type="checkbox"/> V2
				Price gr. C116 (m ²)		dark anthracite <input type="checkbox"/> V3
431603H	431607H	431611H	431615H		431623H	
Price gr. C308 (m ²)	Price gr. C98 (m ²)	Price gr. C107 (m ²)	Price gr. C137 (m ²)		Price gr. C440 (pce.)	
				431619H		
				Price gr. C116 (m ²)		
431604H	431608H	431612H	431616H		431624H	
Price gr. C308 (m ²)	Price gr. C98 (m ²)	Price gr. C107 (m ²)	Price gr. C137 (m ²)		Price gr. C440 (pce.)	
				431620H		
				Price gr. C116 (m ²)		



¹ Glass fibre net on reverse side

² Please note: special pallet. No return, no exchange.

³ High weight only to carry with two persons.

⁴ Decoration elements only available in full boxes.







Original and elegant

The porcelain stoneware Sierra series adds originality and naturalness to living areas thanks to its colors and surface look. The color light-beige authentically reflects the characteristics of sandstone and its subtle color layers with typical color variations. In the anthracite variant, block mosaics in various sizes and cutting angles emphasize the masonry character even further. Matching floor tiles in the sizes 5 x 5 cm and 30 x 60 cm are available in the four colors of the series (light-beige, anthracite and light-grey). The floor and stair tiles (30 x 60 cm) are Protecta-upgraded and feature slip resistance R10/A.

Studio photo



R10/A



anthracite



light-grey



light-beige



Floor tile 30 x 60 cm, 12 x 24 in, structured, R10/A



Stair tile 30 x 60 cm, 12 x 24 in (with grooves), structured, R10/A

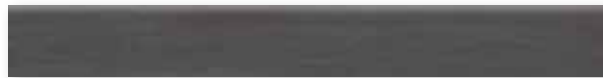

Skirting, rounded 7 x 60 cm, 2 13/16 x 24 in, structured

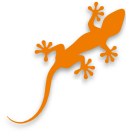

Mosaic 5 x 5 cm, 2 x 2 in

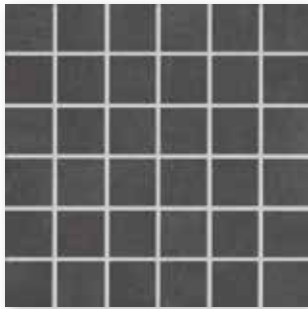

Mosaic sheet 30 x 30 cm, 12 x 12 in anthracite, structured, R10/B



Mosaic sheet 30 x 30 cm, 12 x 12 in light-grey, structured, R10/B

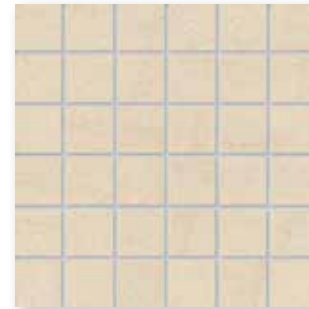

Mosaic sheet 30 x 30 cm, 12 x 12 in light-beige, structured, R10/B

Mosaic: Glass fibre net on reverse side, Sheet: 297 x 297 mm.

Oblong mosaic



Oblong mosaic 30 x 30 cm, 12 x 12 in anthracite, structured, R10/A



Oblong mosaic 30 x 30 cm, 12 x 12 in light-grey, structured, R10/A



Oblong mosaic 30 x 30 cm, 12 x 12 in light-beige, structured, R10/A

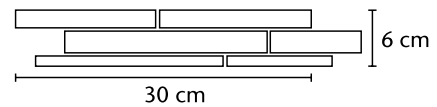

Proposal for borders design: five borders can be taken from one mosaic sheet according to the enclosed sketch = 1.5 lin. m.

Oblong mosaic: Glass fibre net on reverse side, Sheet: 298 x 298 mm.

Mosaic^{1/3}

5 x 5 cm



Oblong Mosaic³

30 x 30 cm

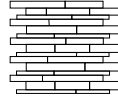

Floor Tiles¹

30 x 60 cm



Stair Tiles^{1/2}

30 x 60 cm

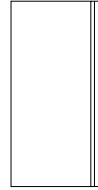

Skirting, rounded¹

7 x 60 cm¹



protected

Sheet: 297 x 297 mm

Sheet: 298 x 298 mm

Nom. dim. - cm/in	5 x 5 / 2 x 2	30 x 30 / 12 x 12	30 x 60 / 12 x 24	30 x 60 / 12 x 24	7 x 60 / 2 13/16 x 24		
Work size	47 x 47 x 9 mm	298 x 298 x 9 mm	297 x 597 x 9 mm	297 x 597 x 9 mm	70 x 597 x 9 mm		
Surface	structured, matt	structured, matt	structured, matt	structured, matt	structured, matt		
m ² /m - pieces	11.111 sheets/m ²	11.111 sheets/m ²	5.556/m ²	1.667/m	1.667/m		
m ² /m - kg	19.833/m ²	20.755/m ²	19.907/m ²	5.973/m	1.357/m		
Bundle - pieces	12 sheets	12 sheets	7	7	22		
Bundle - m ² /m	1.080 m ²	1.080 m ²	1.260 m ²	4.199 m	13.197 m		
Bundle - kg	21.420	22.416	25.081	25.081	17.908		
Pallet - m ²	32.400	32.400	50.396				
Pallet - kg	642.600	672.480	1,003.240				
Product standard	Bla	Bla	Bla	Bla	Bla		
Slip resistance	R10/B	R10/A	R10/A	R10/A			
Stress group	2	2	2	2			
anthracite	431380 Price gr. C314 (m ²)	431386 Price gr. C377 (m ²)	431383 Price gr. C98 (m ²)	431389 Price gr. C474 (pce.)	431392 Price gr. C440 (pce.)		
light-grey	431381 Price gr. C314 (m ²)	431387 Price gr. C377 (m ²)	431384 Price gr. C98 (m ²)	431390 Price gr. C474 (pce.)	431393 Price gr. C440 (pce.)		
light-beige	431382 Price gr. C314 (m ²)	431388 Price gr. C377 (m ²)	431385 Price gr. C98 (m ²)	431391 Price gr. C474 (St.)	431394 Price gr. C440 (pce.)		

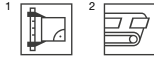

³ Glass fibre net on reverse side

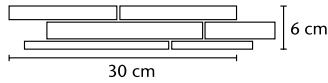

Proposal for borders design: five borders can be taken from one mosaic sheet according to the enclosed sketch = 1.5 lin. m.

Studio photo







Practical in commercial buildings

With a compact product range, the new Skill floor series offers a practical selection of colors and formats. Fine grains, subtle veinings and soft color transitions with a delicate relief characterize the design. With a material thickness of 9 mm, the porcelain stoneware tiles in the sizes of 30 x 60 cm, 60 x 60 cm and the large format of 60 x 120 cm are perfectly suitable for use in commercial buildings. Two stair tile formats round off the series. All tiles have slip resistance R10/A+B and are particularly easy to clean thanks to the Hytect coating.

Rendering



R10/A+B



dark taupe



light sand



warm grey



dark anthracite



Floor tile 30 x 60 cm, 12 x 24 in, structured, R10/A+B



Floor tile 60 x 60 cm, 24 x 24 in, structured, R10/A+B



Floor tile 60 x 120 cm, 24 x 48 in, structured, R10/A+B



Stair tile 30 x 60 cm, 12 x 24 in (with grooves), structured, R10/A+B



Stair tile 30 x 120 cm, 12 x 48 in (with grooves), structured, R10/A+B



Skirting, cut 7 x 60 cm, 2 13/16 x 24 in, structured

Floor Tiles¹

Stair Tiles^{1/2}

Skirting, cut¹

30 x 60 cm



60 x 60 cm

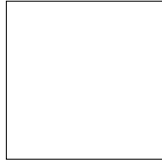

60 x 120 cm^{3/4}



30 x 60 cm



30 x 120 cm



7 x 60 cm



Nom. dim. - cm/in	30 x 60 / 12 x 24	60 x 60 / 24 x 24	60 x 120 / 24 x 48	30 x 60 / 12 x 24	30 x 120 / 12 x 48	7 x 60 / 2 13/16 x 24
Work size	297 x 597 x 9 mm	597 x 597 x 9 mm	597 x 1197 x 9 mm	297 x 597 x 9 mm	297 x 1197 x 9 mm	70 x 597 x 9 mm
Surface	structured, matt	structured, matt	structured, matt	structured, matt	structured, matt	structured, matt
m ² /m - pieces	5.556/m ²	2.778/m ²	1.388/m ²	1.667/m	0.833/m	1.667/m
m ² /m - kg	19.907/m ²	20.371/m ²	21.132/m ²	5.973/m	6.341/m	1.357/m
Bundle - pieces	7	3	2	7	3	26
Bundle - m ² /m	1.260 m ²	1.080 m ²	1.441 m ²	4.199 m	3.601 m	8.998 m
Bundle - kg	25.081	21.999	30.450	25.081	22.836	21.164
Pallet - m ²	50.396	45.356	50.432			
Pallet - kg	1,003.240	923.958	1,065.750			
Product standard	Bla	Bla	Bla	Bla	Bla	Bla
Slip resistance	R10/A+B	R10/A+B	R10/A+B	R10/A+B	R10/A+B	
Stress group	2	2	2	2	2	
dark taupe 	431352H Price gr. A94 (m ²)	431356H Price gr. A106 (m ²)	431363H Price gr. A142 (m ²)	<i>431367H</i> Price gr. <i>A456</i> (pce.)	<i>431371H</i> Price gr. <i>A522</i> (pce.)	431395H Price gr. A438 (pce.)
light sand 	431353H Price gr. A94 (m ²)	431357H Price gr. A106 (m ²)	431364H Price gr. A142 (m ²)	<i>431368H</i> Price gr. <i>A456</i> (pce.)	<i>431372H</i> Price gr. <i>A522</i> (pce.)	431396H Price gr. A438 (pce.)
warm grey 	431354H Price gr. A94 (m ²)	431358H Price gr. A106 (m ²)	431365H Price gr. A142 (m ²)	<i>431369H</i> Price gr. <i>A456</i> (pce.)	<i>431373H</i> Price gr. <i>A522</i> (pce.)	431397H Price gr. A438 (pce.)
dark anthracite 	431355H Price gr. A94 (m ²)	431359H Price gr. A106 (m ²)	431366H Price gr. A142 (m ²)	<i>431370H</i> Price gr. <i>A456</i> (pce.)	<i>431374H</i> Price gr. <i>A522</i> (pce.)	431398H Price gr. A438 (pce.)



³ Please note: special pallet. No return, no exchange.
⁴ High weight only to carry with two persons.

Rendering







Art in interior design

The Solid Ground series, designed in cooperation with the Hadi Teherani architecture office, combines concrete and travertine to create a harmonious design, which radiates stability and elegance. The series offers creative freedom with modern colors and a modular format system. Stair tiles in travertine look with a length of 145 cm are a highlight. Solid Ground provides varied and noble design possibilities for residential areas, offices, hotels and retail shops – a perfect solution for architects, planners and builders.

Rendering / Architect: Hadi Teherani

Decoration elements



Wall tile 30 x 60 cm, 12 x 24 in, natural white, smooth



Decorative tile 30 x 60 cm, 12 x 24 in, natural white, relief



Wall tile 30 x 60 cm, 12 x 24 in, grey green, smooth



Decorative tile 30 x 60 cm, 12 x 24 in, grey green, relief



Wall tile 30 x 60 cm, 12 x 24 in, belgish grey, smooth



Decorative tile 30 x 60 cm, 12 x 24 in, belgish grey, relief



R10/A+B



Concrete



sand white

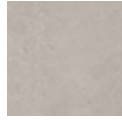

umber grey



warm grey



red clay

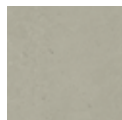

mud green

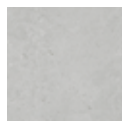

light grey

Travertine



italian white



belgish grey



urban grey



persian red



beach white



nordic grey

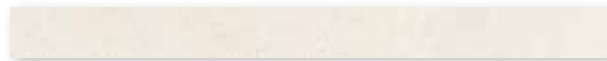

Floor tile 5 x 60 cm, 2 x 24 in, structured, R10/A+B



Floor tile 15 x 60 cm, 6 x 24 in, structured, R10/A+B (only available in Concrete)



Floor tile 30 x 60 cm, 12 x 24 in, structured, R10/A+B
Floor tile 30 x 60 cm, 12 x 24 in, smooth, R10/A+B



Floor tile 60 x 60 cm, 24 x 24 in, structured, R10/A+B (only available in Concrete)

Travertine



italian white



belgish grey



urban grey



persian red



beach white



nordic grey



Floor tile 60 x 120 cm, 24 x 48 in, smooth, R10/A+B (only available in Travertine)



Concrete



sand white

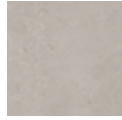

umber grey

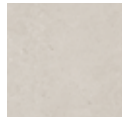

warm grey



light grey



Floor tile 120 x 120 cm, structured, R10/A+B (only available in Concrete)



R10/A+B



Concrete



sand white

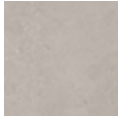

umber grey



warm grey



red clay

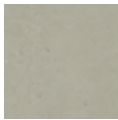

mud green

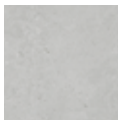

light grey

Travertine



italian white



belgish grey



urban grey



persian red



beach white



nordic grey



Stair tile 30 x 60 cm, 12 x 24 in (with grooves), structured, R10/A+B
Stair tile 30 x 60 cm, 12 x 24 in (with grooves), smooth, R10/A+B

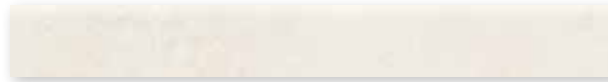

Skirting, rounded 7 x 60 cm, 2 13/16 x 24 in, structured
Skirting, rounded 7 x 60 cm, 2 13/16 x 24 in, smooth



Stair tile with bevel 31 x 145 cm, 12 13/64 x 57 in, smooth, R10/A+B (only available in Travertine)



Riser 28 x 145 cm, 11 x 57 in, smooth, R10/A+B (only available in Travertine)



R10/A+B



Mosaik 5 x 15, 2 x 6 in

Concrete



Mosaic sheet 30 x 30 cm, 12 x 12 in
sand white, smooth, R10/A+B



Mosaic sheet 30 x 30 cm, 12 x 12 in
umber grey, smooth, R10/A+B



Mosaic sheet 30 x 30 cm, 12 x 12 in
warm grey, smooth, R10/A+B

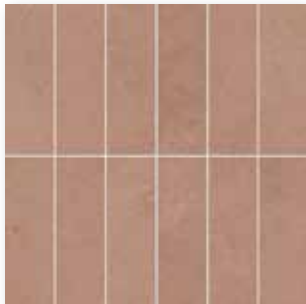

Mosaic sheet 30 x 30 cm, 12 x 12 in
red clay, smooth, R10/A+B

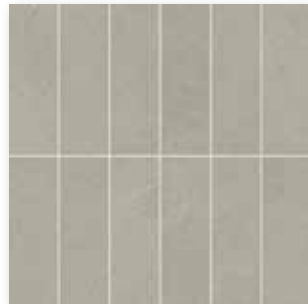

Mosaic sheet 30 x 30 cm, 12 x 12 in
mud green, smooth, R10/A+B



Mosaic sheet 30 x 30 cm, 12 x 12 in
light grey, smooth, R10/A+B

Travertine



Mosaic sheet 30 x 30 cm, 12 x 12 in
italian white, smooth, R10/A+B



Mosaic sheet 30 x 30 cm, 12 x 12 in
belgish grey, smooth, R10/A+B



Mosaic sheet 30 x 30 cm, 12 x 12 in
urban grey, smooth, R10/A+B



Mosaic sheet 30 x 30 cm, 12 x 12 in
persian red, smooth, R10/A+B



Mosaic sheet 30 x 30 cm, 12 x 12 in
beach white, smooth, R10/A+B



Mosaic sheet 30 x 30 cm, 12 x 12 in
nordic grey, smooth, R10/A+B

Mosaic: glass fibre net on reverse side,
sheet: 297 x 297 mm

Wall Tile²

Decoration Elements

Floor Tiles¹

30 x 60 cm



30 x 60 cm

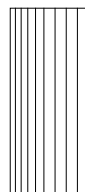

5 x 60 cm



5 x 60 cm



15 x 60 cm

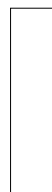

30 x 60 cm



30 x 60 cm

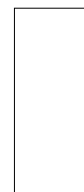

	Concrete	Concrete	Concrete	Travertine	Concrete	Concrete	Travertine
Nom. dim. - cm/in	30 x 60 / 12 x 24	30 x 60 / 12 x 24	5 x 60 / 2 x 24	5 x 60 / 2 x 24	15 x 60 / 6 x 24	30 x 60 / 12 x 24	30 x 60 / 12 x 24
Work size	297 x 597 x 6 mm	297 x 597 x 6 mm	47 x 597 x 9 mm	47 x 597 x 9 mm	147 x 597 x 9 mm	297 x 597 x 9 mm	297 x 597 x 9 mm
Surface	smooth, stone-matt	relief, stone-matt	strukturier, matt	smooth, matt	structured, matt	structured, matt	structured, matt
m ² - pieces	5.556	5.556	33.333	33.333	11.111	5.556/m ²	5.556/m ²
m ² - kg	10.279	10.279	6.633	6.633	19.900	19.907/m ²	19.907/m ²
Bundle - pieces	13	13	39	39	13	7	7
Bundle - m ²	2.340	2.340	1.180	1.180	1.170	1.260 m ²	1.260 m ²
Bundle - kg	24.050	24.050	23.283	23.283	23.283	25.081	25.081
Pallet - m ²	112.311	112.311	46.800	46.800	46.800	50.396	50.396
Pallet - kg	1,154.400	1,154.400	931.320	931.320	931.311	1,003.240	1,003.240
Product standard	BIII	BIII	Bla	Bla	Bla	Bla	Bla
Slip resistance			R10/A+B	R10/A+B	R10/A+B	R10/A+B	R10/A+B
Stress group			2	2	2	2	2
natural white <input type="checkbox"/>	203505H Price gr. C107 (m ²)	203506H Price gr. C116 (m ²)					
grey green <input type="checkbox"/>	203507H Price gr. C107 (m ²)	203508H Price gr. C116 (m ²)					
belgish grey <input type="checkbox"/>	203509H Price gr. C107 (m ²)	203510H Price gr. C116 (m ²)					
sand white <input type="checkbox"/>			436110H Price gr. C218 (m ²)		436116H Price gr. C200 (m ²)	436122H Price gr. C125 (m ²)	
italian white <input type="checkbox"/>				436156H Price gr. C218 (m ²)			436162H Price gr. C125 (m ²)
umber grey <input type="checkbox"/>			436111H Price gr. C218 (m ²)		436117H Price gr. C200 (m ²)	436123H Price gr. C125 (m ²)	
belgish grey <input type="checkbox"/>				436157H Price gr. C218 (m ²)			436163H Price gr. C125 (m ²)
warm grey <input type="checkbox"/>			436112H Price gr. C218 (m ²)		436118H Price gr. C200 (m ²)	436124H Price gr. C125 (m ²)	
urban grey <input type="checkbox"/>				436158H Price gr. C218 (m ²)			436164H Price gr. C125 (m ²)
red clay <input type="checkbox"/>			436113H Price gr. C218 (m ²)		436119H Price gr. C200 (m ²)	436125H Price gr. C125 (m ²)	
persian red <input type="checkbox"/>				436159H Price gr. C218 (m ²)			436165H Price gr. C125 (m ²)
mud green <input type="checkbox"/>			436114H Price gr. C218 (m ²)		436120H Price gr. C200 (m ²)	436126H Price gr. C125 (m ²)	
beach white <input type="checkbox"/>				436160H Price gr. C218 (m ²)			436166H Price gr. C125 (m ²)
light grey <input type="checkbox"/>			436115H Price gr. C218 (m ²)		436121H Price gr. C200 (m ²)	436127H Price gr. C125 (m ²)	
nordic grey <input type="checkbox"/>				436161H Price gr. C218 (m ²)			436167H Price gr. C125 (m ²)



² not frost-proof

Floor Tiles¹

Mosaic⁵

60 x 60 cm

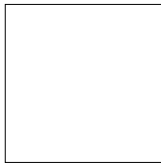

60 x 120 cm^{2/3}



120 x 120 cm^{2/3/4}

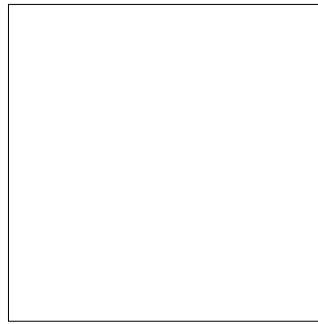

5 x 15 cm



5 x 15 cm



+

Concrete			Travertine			Concrete			Concrete Sheet 297 x 297 mm			Travertine Sheet 297 x 297 mm				
60 x 60 / 24 x 24	60 x 120 / 24 x 48	120 x 120 / 48 x 48	60 x 120 / 24 x 48	120 x 120 / 48 x 48	120 x 120 / 48 x 48	30 x 30 / 12 x 12	30 x 30 / 12 x 12	30 x 30 / 12 x 12	30 x 30 / 12 x 12	30 x 30 / 12 x 12	30 x 30 / 12 x 12	30 x 30 / 12 x 12	30 x 30 / 12 x 12	Nom. dim. - cm/in		
597 x 597 x 9 mm	597 x 1197 x 9 mm	1197 x 1197 x 9 mm	597 x 1197 x 9 mm	1197 x 1197 x 9 mm	1197 x 1197 x 9 mm	297 x 297 x 9 mm	297 x 297 x 9 mm	297 x 297 x 9 mm	297 x 297 x 9 mm	297 x 297 x 9 mm	297 x 297 x 9 mm	297 x 297 x 9 mm	297 x 297 x 9 mm	Work size		
structured, matt	smooth, matt	structured, matt	smooth, matt	structured, matt	structured, matt	structured, matt	smooth, matt	structured, matt	smooth, matt	structured, matt	smooth, matt	structured, matt	smooth, matt	Surface		
2.778	1.388	0.694	1.388	0.694	0.694	11.111	11.111	11.111	11.111	11.111	11.111	11.111	11.111	m ² - pieces		
20.371	21.132	21.098	21.132	21.098	21.098	19.833	19.833	19.833	19.833	19.833	19.833	19.833	19.833	m ² - kg		
3	2	2	2	2	2	12 sheets	12 sheets	12 sheets	12 sheets	12 sheets	12 sheets	12 sheets	12 sheets	Bundle - pieces		
1.080 m ²	1.440 m ²	2.882 m ²	1.440 m ²	2.882 m ²	2.882 m ²	0.1080	0.1080	0.1080	0.1080	0.1080	0.1080	0.1080	0.1080	Bundle - m ²		
21.999	30.450	60.800	30.450	60.800	60.800	21.420	21.420	21.420	21.420	21.420	21.420	21.420	21.420	Bundle - kg		
45.356	50.432	57.637	50.432	57.637	57.637	32.400	32.400	32.400	32.400	32.400	32.400	32.400	32.400	Pallet - m ²		
923.958	1,065.750	1,216.000	1,065.750	1,216.000	1,216.000	642.600	642.600	642.600	642.600	642.600	642.600	642.600	642.600	Pallet - kg		
Bla	Bla	Bla	Bla	Bla	Bla	Bla	Bla	Bla	Bla	Bla	Bla	Bla	Bla	Product standard		
R10/A+B	R10/A+B	R10/A+B	R10/A+B	R10/A+B	R10/A+B	R10/A+B	R10/A+B	R10/A+B	R10/A+B	R10/A+B	R10/A+B	R10/A+B	R10/A+B	Slip resistance		
2	2	2	2	2	2	2	2	2	2	2	2	2	2	Stress group		
436128H		436134		436134		436138H		436138H		436138H		436138H		sand white	V2	
Price gr. C140 (m ²)		Price gr. C188 (m ²)		Price gr. C188 (m ²)		Price gr. C348 (m ²)		Price gr. C348 (m ²)		Price gr. C348 (m ²)		Price gr. C348 (m ²)		italian white	V3	
	436168H													umber grey	V2	
	Price gr. C152 (m ²)													belgish grey	V3	
436129H		436135		436135		436139H		436139H		436139H		436139H		warm grey	V2	
Price gr. C140 (m ²)		Price gr. C188 (m ²)		Price gr. C188 (m ²)		Price gr. C348 (m ²)		Price gr. C348 (m ²)		Price gr. C348 (m ²)		Price gr. C348 (m ²)		urban grey	V3	
	436169H													red clay	V2	
	Price gr. C152 (m ²)													persian red	V3	
436130H		436136		436136		436140H		436140H		436140H		436140H		mud green	V2	
Price gr. C140 (m ²)		Price gr. C188 (m ²)		Price gr. C188 (m ²)		Price gr. C348 (m ²)		Price gr. C348 (m ²)		Price gr. C348 (m ²)		Price gr. C348 (m ²)		beach white	V3	
	436170H													light grey	V2	
	Price gr. C152 (m ²)													nordic grey	V3	
436131H		436171H		436171H		436141H		436141H		436141H		436141H				
Price gr. C140 (m ²)		Price gr. C152 (m ²)		Price gr. C152 (m ²)		Price gr. C348 (m ²)		Price gr. C348 (m ²)		Price gr. C348 (m ²)		Price gr. C348 (m ²)				
	436172H															
	Price gr. C152 (m ²)															
436132H		436172H		436172H		436142H		436142H		436142H		436142H				
Price gr. C140 (m ²)		Price gr. C152 (m ²)		Price gr. C152 (m ²)		Price gr. C348 (m ²)		Price gr. C348 (m ²)		Price gr. C348 (m ²)		Price gr. C348 (m ²)				
	436173H															
	Price gr. C152 (m ²)															
436133H		436173H		436173H		436143H		436143H		436143H		436143H				
Price gr. C140 (m ²)		Price gr. C152 (m ²)		Price gr. C152 (m ²)		Price gr. C348 (m ²)		Price gr. C348 (m ²)		Price gr. C348 (m ²)		Price gr. C348 (m ²)				



¹ High weight only to carry with two persons.
² Please note: special pallet. No return, no exchange.
³ without Hytect coating; with Protecta upgrading
⁴ Glass fibre net on reverse side



Stair
Tile^{1/2}

30 x 60 cm

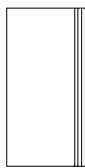
Stair Tile
with bevel^{2/3/4}

31 x 145 cm

Riser^{2/3/4}

28 x 145 cm

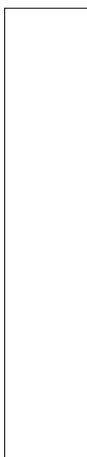
Skirting, rounded¹

7 x 60 cm



7 x 60 cm



	Concrete	Travertine	Travertine	Concrete	Travertine		
Nom. dim. - cm/in	30 x 60 / 12 x 24	31 x 145 / 12 3/8 x 58	28 x 145 / 11 3/16 x 58	7 x 60 / 2 13/16 x 24	7 x 60 / 2 13/16 x 24		
Work size	297 x 597 x 9 mm	307 x 1447 x 10.5 mm	280 x 1447 x 10.5 mm	70 x 597 x 9 mm	70 x 597 x 9 mm		
Surface	structured, matt	smooth, matt	smooth, matt	structured, matt	structured, matt		
m - pieces	1.667	0.690	0.690	1.667	1.667		
m - kg	5.973	7.480	6.716	1.357	1.357		
Bundle - pieces	7	2	2	15	15		
Bundle - m	4.199	2.899	2.899	8.998	8.998		
Bundle - kg	25.081	21.682	19.466	12.210	12.210		
Pallet - m ²							
Pallet - kg							
Product standard	Bla	Ala	Ala	Bla	Bla		
Slip resistance	R10/A+B	R10/A+B	R10/A+B				
Stress group	2	2	2				
	436144H Price gr. C474 (pce.)			436150H Price gr. C440 (pce.)			
sand white		436180H Price gr. C558 (pce.)	436186H Price gr. C525 (pce.)		436192H Price gr. C440 (pce.)		
italian white							
	436145H Price gr. C474 (pce.)			436151H Price gr. C440 (pce.)			
umber grey		436181H Price gr. C558 (pce.)	436187H Price gr. C525 (pce.)		436193H Price gr. C440 (pce.)		
belgish grey							
	436146H Price gr. C474 (pce.)			436152H Price gr. C440 (pce.)			
warm grey		436182H Price gr. C558 (pce.)	436188H Price gr. C525 (pce.)		436194H Price gr. C440 (pce.)		
urban grey							
	436147H Price gr. C474 (pce.)			436153H Price gr. C440 (pce.)			
red clay		436183H Price gr. C558 (pce.)	436189H Price gr. C525 (pce.)		436195H Price gr. C440 (pce.)		
persian red							
	436148H Price gr. C474 (pce.)			436154H Price gr. C440 (pce.)			
mud green		436184H Price gr. C558 (pce.)	436190H Price gr. C525 (pce.)		436196H Price gr. C440 (pce.)		
beach white							
	436149H Price gr. C474 (pce.)			436155H Price gr. C440 (pce.)			
light grey		436185H Price gr. C558 (pce.)	436191H Price gr. C525 (pce.)		436197H Price gr. C440 (pce.)		
nordic grey							

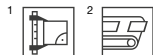

³ Rectified only on the two short sides. The long side can not be rectified.

⁴ For details, refer to page 538

Rendering / Architect: Hadi Teherani







Naturally expressive

Solid Rock – this name alone is a clear statement. And the robust quality of this series is almost set in stone. Solid Rock eliminates the boundaries between inside and outside. Purely aesthetically, because it brings the power of nature into bathrooms, foyers and all other rooms. But there are also unlimited possibilities when it comes to laying. Because interior tiles in combination with Solid Rock patio tiles create seamless transitions between indoors and outdoors. A highlight for hotels and restaurants, but also in private living areas. The lively structure of the tiles accentuates rooms clearly and stringently. The Move wall bond further expands the design freedom for architects and planners. This is due to the different and carefully selected color shades in which this aesthetically truly stunning tile is available. Solid Rock is Protecta-upgraded and thus resistant to dirt and stains.

Rendering / Architect: VSBL, Belgrade, Serbia



R10/A+B



dark green

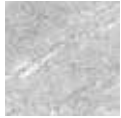

silver

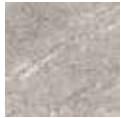

mud grey

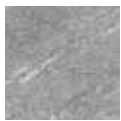

natural grey



deep grey



Wall/Floor tile 5 x 60 cm, 2 x 24 in, structured, R10/A+B



Wall/Floor tile 10 x 60 cm, 4 x 24 in, structured, R10/A+B



Wall/Floor tile 15 x 60 cm, 6 x 24 in, structured, R10/A+B



Wall/Floor tile 30 x 60 cm, 12 x 24 in, structured, R10/A+B



Wall/Floor tile 60 x 60 cm, 24 x 24 in, structured, R10/A+B



Wall/Floor tile 60 x 120 cm, 24 x 48 in, structured, R10/A+B



Stair tile 30 x 60 cm, 12 x 24 in (with grooves), structured, R10/A+B



Skirting, rounded 7 x 60 cm, 2 13/16 x 24 in, structured



dark green

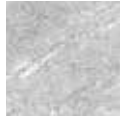

silver



mud grey



natural grey



deep grey



Patio tile 60 x 60 cm, 24 x 24 in, structured, R11/B



Patio tile 60 x 120 cm, 24 x 48 in, structured, R11/B



Mosaic 5 x 5 cm, 2 x 2 in



Mosaic sheet 30 x 30 cm, 12 x 12 in dark green, structured, R10/A+B

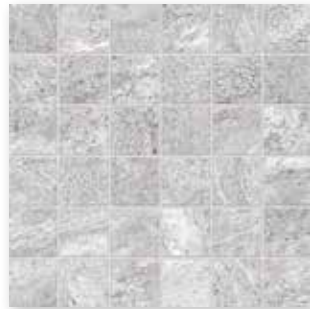

Mosaic sheet 30 x 30 cm, 12 x 12 in silver, structured, R10/A+B



Mosaic sheet 30 x 30 cm, 12 x 12 in mud grey, structured, R10/A+B

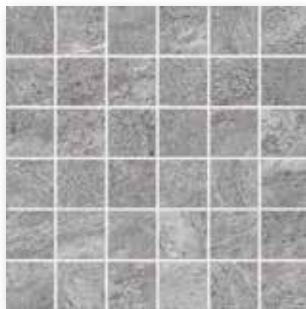

Mosaic sheet 30 x 30 cm, 12 x 12 in natural grey, structured, R10/A+B



Mosaic sheet 30 x 30 cm, 12 x 12 in deep grey, structured, R10/A+B

Glass fibre net on reverse side, Sheet: 297 x 297 mm.

Decoration elements

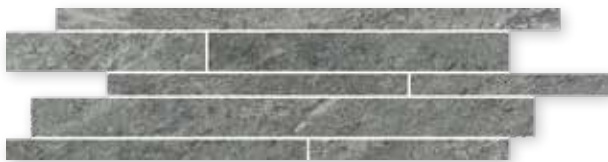

Border Move 15 x 60 cm, 6 x 24 in, dark green, structured, R10/A+B



Border Move 15 x 60 cm, 6 x 24 in, silver, structured, R10/A+B



Border Move 15 x 60 cm, 6 x 24 in, mud grey, structured, R10/A+B



Border Move 15 x 60 cm, 6 x 24 in, natural grey, structured, R10/A+B



Border Move 15 x 60 cm, 6 x 24 in, deep grey, structured, R10/A+B

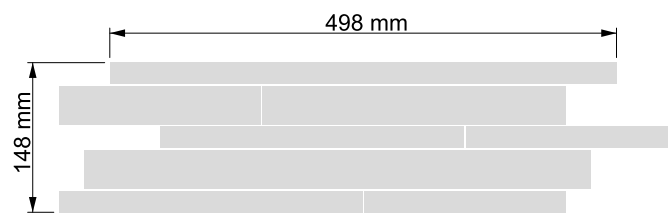

Glass fibre net on reverse side, Sheet: 148 x 598 mm

Mosaic^{1/3} Wall and Floor Tiles¹

5 x 5 cm



5 x 60 cm²



10 x 60 cm²



15 x 60 cm²



30 x 60 cm



60 x 60 cm

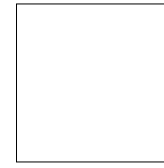



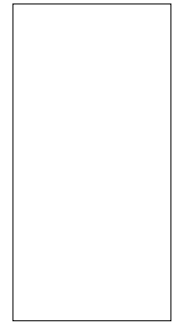

60 x 120 cm^{4/5}



protected

Sheet: 297 x 297 mm

Nom. dim. - cm/in	5 x 5 / 2 x 2	5 x 60 / 2 x 24	10 x 60 / 4 x 24	15 x 60 / 6 x 24	30 x 60 / 12 x 24	60 x 60 / 24 x 24	60 x 120 / 24 x 48
Work size	47 x 47 x 9 mm	46 x 596 x 9 mm	96 x 596 x 9 mm	146 x 596 x 9 mm	297 x 596 x 9 mm	596 x 596 x 9 mm	596 x 1194 x 9 mm
Surface	structured, matt	structured, matt	structured, matt	structured, matt	structured, matt	structured, matt	structured, matt
m ² - pieces	11.111 sheets	33.333	16.667	11.111	5.556	2.778	1.388
m ² - kg	19.833	19.899	20.283	19.899	19.841	19.288	21.514
Bundle - pieces	12 sheets	39	17	13	7	3	2
Bundle - m ²	1.080 m ²	1.170	1.020	1.170	1.260	1.080	1.441
Bundle - kg	21.420	23.283	20.689	23.283	24.997	20.829	31.000
Pallet - m ²	32.400	46.800	40.799	46.800	50.396	43.197	50.432
Pallet - kg	642.600	931.320	827.560	931.320	999.880	833.160	1,085.000
Product standard	Bla	Bla	Bla	Bla	Bla	Bla	Bla
Slip resistance	R10/A+B	R10/A+B	R10/A+B	R10/A+B	R10/A+B	R10/A+B	R10/A+B
Stress group	2	2	2	2	2	2	2
dark green 	431020 Price gr. W303 (m ²)	<i>431021</i> Price gr. <i>W210</i> (m ²)	<i>431022</i> Price gr. <i>W210</i> (m ²)	<i>431023</i> Price gr. <i>W186</i> (m ²)	431024 Price gr. W102 (m ²)	431025 Price gr. W117 (m ²)	431026 Price gr. W156 (m ²)
silver 	430853 Price gr. W303 (m ²)	<i>430857</i> Price gr. <i>W210</i> (m ²)	<i>430861</i> Price gr. <i>W210</i> (m ²)	<i>430865</i> Price gr. <i>W186</i> (m ²)	430869 Price gr. W102 (m ²)	430873 Price gr. W117 (m ²)	430877 Price gr. W156 (m ²)
mud grey 	430854 Price gr. W303 (m ²)	<i>430858</i> Price gr. <i>W210</i> (m ²)	<i>430862</i> Price gr. <i>W210</i> (m ²)	<i>430866</i> Price gr. <i>W186</i> (m ²)	430870 Price gr. W102 (m ²)	430874 Price gr. W117 (m ²)	430878 Price gr. W156 (m ²)
natural grey 	430855 Price gr. W303 (m ²)	<i>430859</i> Price gr. <i>W210</i> (m ²)	<i>430863</i> Price gr. <i>W210</i> (m ²)	<i>430867</i> Price gr. <i>W186</i> (m ²)	430871 Price gr. W102 (m ²)	430875 Price gr. W117 (m ²)	430879 Price gr. W156 (m ²)
deep grey 	430856 Price gr. W303 (m ²)	<i>430860</i> Price gr. <i>W210</i> (m ²)	<i>430864</i> Price gr. <i>W210</i> (m ²)	<i>430868</i> Price gr. <i>W186</i> (m ²)	430872 Price gr. W102 (m ²)	430876 Price gr. W117 (m ²)	430880 Price gr. W156 (m ²)

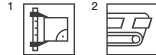

³ Glass fibre net on reverse side

⁴ High weight only to carry with two persons.

⁵ Please note: special pallet. No return, no exchange.

Decoration
Elements^{1/5/6}

15 x 60 cm



Stair
Tile^{1/2}

30 x 60 cm



Skirting,
rounded¹

7 x 60 cm



Patio Tiles^{1/3}

60 x 60 cm

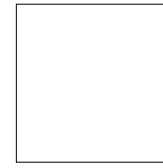

60 x 120 cm⁴

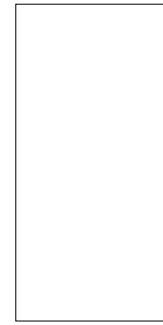

protected

Border Move
Sheet: 148 x 598 mm

	15 x 60 / 6 x 24	30 x 60 / 12 x 24	7 x 60 / 2 13/16 x 24	60 x 60 / 24 x 24	60 x 120 / 24 x 48	Nom. dim. - cm/in
	148 x 598 x 9 mm	297 x 596 x 9 mm	70 x 596 x 9 mm	596 x 596 x 20 mm	596 x 1194 x 20 mm	Work size
	structured, matt	structured, matt	structured, matt	structured, matt	structured, matt	Surface
	2.000/m	1.667/m	1.667/m	2.778/m ²	1.388/m ²	m ² - pieces
	2.780/m	5.973/m	1.357/m	47.226/m ²	45.110/m ²	m ² - kg
	2	7	22	2	1	Bundle - pieces
	1.000 m	4.199 m	13.197 m	0.720 m ²	0.720 m ²	Bundle - m ²
	2.780	25.081	17.908	34.000	32.500	Bundle - kg
				21.598	25.216	Pallet - m ²
				1,020.000	1,137.500	Pallet - kg
	Bla	Bla	Bla	Bla	Bla	Product standard
	R10/A+B	R10/A+B		R11/B	R11/B	Slip resistance
	2	2		4	4	Stress group
	431029	431030	431031	431027	431028	
	Price gr. W488 (pce.)	Price gr. W473 (pce.)	Price gr. W439 (pce.)	Price gr. W177 (m ²)	Price gr. W216 (m ²)	dark green <input type="checkbox"/> V2
	430897	430893	430889	430881	430885	silver <input type="checkbox"/> V2
	Price gr. W488 (pce.)	Price gr. W473 (pce.)	Price gr. W439 (pce.)	Price gr. W177 (m ²)	Price gr. W216 (m ²)	
	430898	430894	430890	430882	430886	mud grey <input type="checkbox"/> V2
	Price gr. W488 (pce.)	Price gr. W473 (pce.)	Price gr. W439 (pce.)	Price gr. W177 (m ²)	Price gr. W216 (m ²)	
	430899	430895	430891	430883	430887	natural grey <input type="checkbox"/> V2
	Price gr. W488 (pce.)	Price gr. W473 (pce.)	Price gr. W439 (pce.)	Price gr. W177 (m ²)	Price gr. W216 (m ²)	
	430900	430896	430892	430884	430888	deep grey <input type="checkbox"/> V2
	Price gr. W488 (pce.)	Price gr. W473 (pce.)	Price gr. W439 (pce.)	Price gr. W177 (m ²)	Price gr. W216 (m ²)	

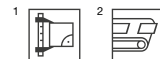

- ³ High weight only to carry with two persons.
⁴ Please note: special pallet. No return, no exchange.
⁵ Glass fibre net on reverse side
⁶ Decoration elements only available in full boxes.







Classics for the bathroom

If plain white tiled walls previously were considered perhaps the most timeless setting for the bathroom, then Stone Concept is another variant which has what it takes to become a classic: organic marble and natural stone looks in the proven 30 x 60 cm format create a cosy, warm ambience and transform the bathroom into a feel-good oasis. With six different designs and surfaces ranging from transparent glossy to stone-matt, the series opens up flexible design options and always remains a timeless setting in its natural simplicity for the private retreat or the hotel bathroom.

Rendering

Decoration elements



Wall tile 30 x 60 cm, 12 x 24 in, Calacatta gold, smooth, glossy



Decorative tile 30 x 60 cm, 12 x 24 in, Calacatta gold, relief, glossy



Wall tile 30 x 60 cm, 12 x 24 in, Calacatta gold, smooth, silky matt



Decorative tile 30 x 60 cm, 12 x 24 in, Calacatta gold, relief, silky matt



Wall tile 30 x 60 cm, 12 x 24 in, Carrara bianco, smooth, glossy



Wall tile 30 x 60 cm, 12 x 24 in, Carrara bianco, smooth, silky matt



Wall tile 30 x 60 cm, 12 x 24 in, Patagonia, smooth, glossy



Wall tile 30 x 60 cm, 12 x 24 in, Vals Stone sand-beige, structured, stone-matt



Wall tile 30 x 60 cm, 12 x 24 in, Patagonia, smooth, stone-matt



Wall tile 30 x 60 cm, 12 x 24 in, Vals Stone anthracite, structured, stone-matt

Decoration elements



Wall tile 30 x 60 cm, 12 x 24 in, Silk Stone powder-beige, smooth, silky matt



Decorative tile 30 x 60 cm, 12 x 24 in, Silk Stone puderbeige, relief, silky matt



Wall tile 30 x 60 cm, 12 x 24 in, Silk Stone pebble-grey, smooth, silky matt



Decorative tile 30 x 60 cm, 12 x 24 in, Silk Stone pebble-grey, relief, silky matt

Decoration elements



Wall tile 30 x 60 cm, 12 x 24 in, Travertin cream beige, smooth, silky matt



Decorative tile 30 x 60 cm, 12 x 24 in, Travertin cream beige, relief, silky matt



Wall tile 30 x 60 cm, 12 x 24 in, Travertin grey beige, smooth, silky matt



Decorative tile 30 x 60 cm, 12 x 24 in, Travertin grey beige, relief, silky matt

Wall Tile

Decoration
Element

Wall Tile

Decoration
Element

Wall Tiles

30 x 60 cm

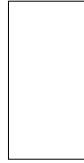

Decorative tile

Decorative tile

	30 x 60 / 12 x 24	30 x 60 / 12 x 24	30 x 60 / 12 x 24	30 x 60 / 12 x 24	30 x 60 / 12 x 24	30 x 60 / 12 x 24	Nom. dim. - cm/in
	297 x 597 x 6 mm	297 x 597 x 6 mm	297 x 597 x 6 mm	297 x 597 x 6 mm	297 x 597 x 6 mm	297 x 597 x 6 mm	Work size
	smooth, glossy	relief, glossy	smooth, silky-matt	relief, silky-matt	smooth, stone-matt	structured, stone-matt	Surface
	5.556	5.556	5.556	5.556	5.556	5.556	m ² - pieces
	10.279	10.279	10.279	10.279	10.279	10.279	m ² - kg
	13	11	13	11	13	13	Bundle - pieces
	2.340	1.980	2.340	1.980	2.340	2.340	Bundle - m ²
	24.050	21.241	24.050	21.241	24.050	24.050	Bundle - kg
	112.311	95.032	112.311	95.032	112.311	112.311	Pallet - m ²
	1,154.400	1,019.568	1,154.400	1,019.568	1,154.400	1,154.400	Pallet - kg
	BIII	BIII	BIII	BIII	BIII	BIII	Product standard
	203511	203514	203515	203521			Calacatta gold <input type="checkbox"/> V3
	Price gr. C56 (m ²)	Price gr. C56 (m ²)	Price gr. C56 (m ²)	Price gr. C56 (m ²)			
	203512		203516				Carrara bianco <input type="checkbox"/> V2
	Price gr. C56 (m ²)		Price gr. C56 (m ²)				
	203513				203526		Patagonia <input type="checkbox"/> V4
	Price gr. C56 (m ²)				Price gr. C56 (m ²)		
						203527	Vals Stone
						Price gr. C56 (m ²)	sand-beige <input type="checkbox"/> V2
						203528	Vals Stone
						Price gr. C56 (m ²)	anthracite <input type="checkbox"/> V2
			203517	203522			Silk Stone
			Price gr. C56 (m ²)	Price gr. C56 (m ²)			powder-beige <input type="checkbox"/> V2
			203518	203523			Silk Stone
			Price gr. C56 (m ²)	Price gr. C56 (m ²)			pebble-grey <input type="checkbox"/> V2
			203519	203524			Travertin
			Price gr. C56 (m ²)	Price gr. C56 (m ²)			cream-beige <input type="checkbox"/> V2
			203520	203525			Travertin
			Price gr. C56 (m ²)	Price gr. C56 (m ²)			grey beige <input type="checkbox"/> V3





Natural elegance

The Stone design combines soft grains, natural veinings and subtle shades to create a cosy look. The color range includes shades from beige to anthracite and emphasizes the naturalness and elegance of the tiles. The tiles of the Stone Duo series are all provided with the innovative and easy-to-clean Hytect surface. This feature not only ensures easy care, but also long-lasting beauty and makes the series the ideal choice for demanding builders.

Rendering



light-grey



mud



beige



anthracite



Floor tile, Design Stone, 30 x 60 cm, 12 x 24 in, structured, R10/A+B



Floor tile, Design Ceppo, 30 x 60 cm, 12 x 24 in, structured, R10/A+B



Floor tile, Design Stone, 60 x 60 cm, 24 x 24 in, structured, R10/A+B



Floor tile, Design Ceppo, 60 x 60 cm, 24 x 24 in, structured, R10/A+B



Floor tile, Design Stone, 60 x 120 cm, 24 x 48 in, structured, R10/A+B

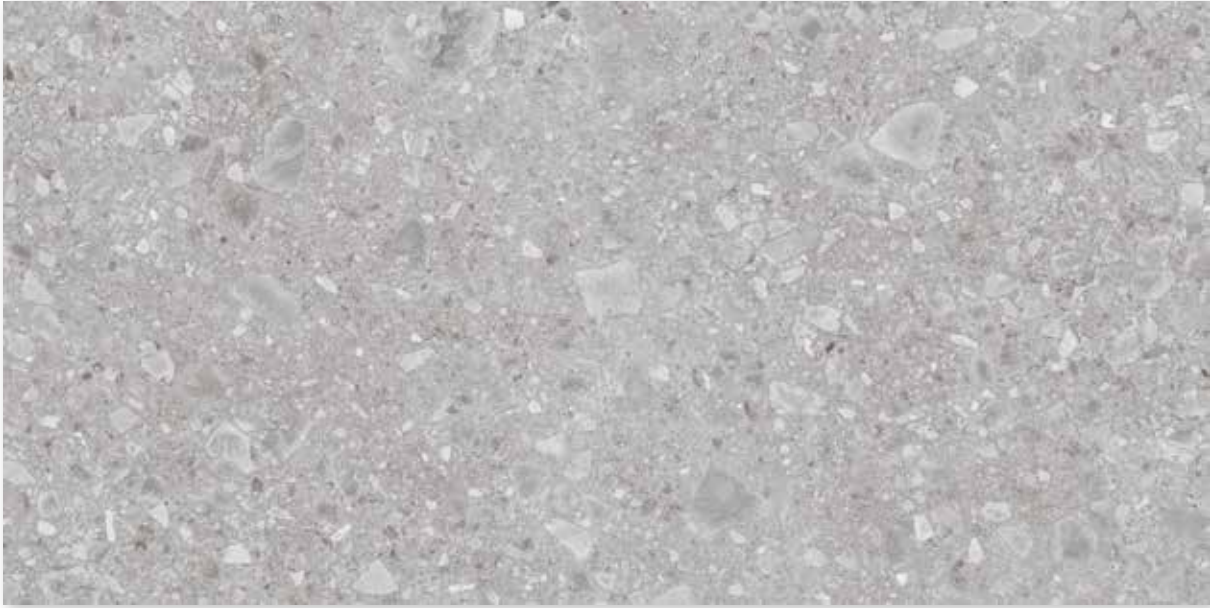

Floor tile, Design Ceppo, 60 x 120 cm, 24 x 48 in, structured, R10/A+B



Stair tile, Design Stone, 30 x 60 cm, 12 x 24 in (with grooves), structured, R10/A+B



Stair tile, Design Ceppo, 30 x 60 cm, 12 x 24 in (with grooves), structured, R10/A+B



Skirting, rounded, Design Stone, 7 x 60 cm, 2 13/16 x 24 in, structured



Skirting, rounded, Design Ceppo, 7 x 60 cm, 2 13/16 x 24 in, structured



Mosaik 5 x 5, 2 x 2 in

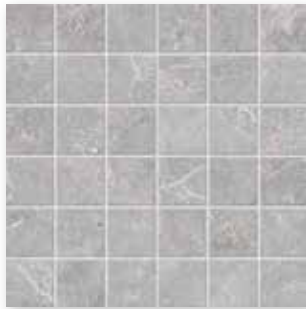

Mosaic sheet, Design Stone
30 x 30 cm, 12 x 12 in, light-grey,
structured, R10/A+B

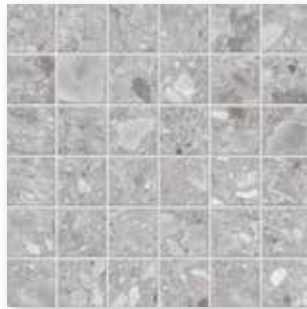

Mosaic sheet, Design Ceppo
30 x 30 cm, 12 x 12 in, light-grey,
structured, R10/A+B



Mosaic sheet, Design Stone
30 x 30 cm, 12 x 12 in, mud,
structured, R10/A+B

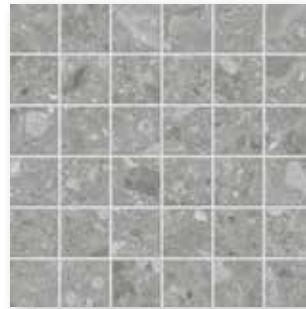

Mosaic sheet, Design Ceppo
30 x 30 cm, 12 x 12 in, mud,
structured, R10/A+B



Mosaic sheet, Design Stone
30 x 30 cm, 12 x 12 in, beige,
structured, R10/A+B



Mosaic sheet, Design Ceppo
30 x 30 cm, 12 x 12 in, beige,
structured, R10/A+B

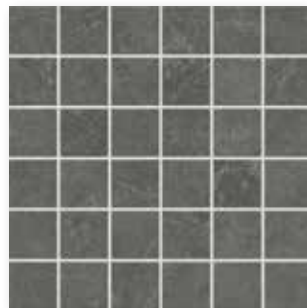

Mosaic sheet, Design Stone
30 x 30 cm, 12 x 12 in, anthracite,
structured, R10/A+B

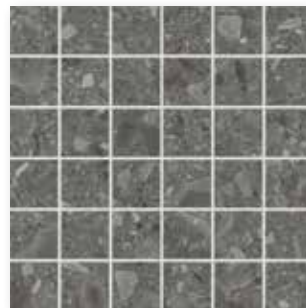

Mosaic sheet, Design Ceppo
30 x 30 cm, 12 x 12 in, anthracite,
structured, R10/A+B

Decoration elements



Mosaic sheet, Design Twins
30 x 30 cm, 12 x 12 in, light-grey,
structured, R10/A+B



Mosaic sheet, Design Twins
30 x 30 cm, 12 x 12 in, mud,
structured, R10/A+B



Mosaic sheet, Design Twins
30 x 30 cm, 12 x 12 in, beige,
structured, R10/A+B

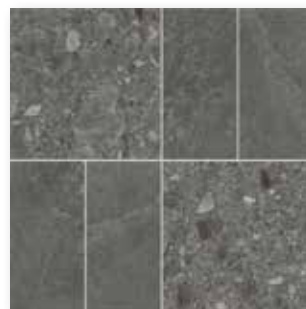

Mosaic sheet, Design Twins
30 x 30 cm, 12 x 12 in, anthracite,
structured, R10/A+B

Mosaic: glass fibre net on reverse side,
sheet: 297 x 297 mm

Mosaic^{1/2}

Floor Tiles¹

5 x 5 cm



5 x 5 cm



30 x 60 cm

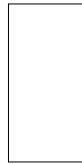

30 x 60 cm



60 x 60 cm

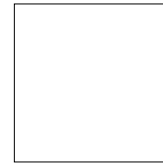

60 x 60 cm

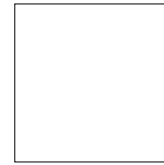

Stone		Ceppo		Stone		Ceppo		Nom. dim. - cm/in
Sheet: 297 x 297 mm		Sheet: 297 x 297 mm		Sheet: 297 x 297 mm		Sheet: 297 x 297 mm		
5 x 5 / 2 x 2	5 x 5 / 2 x 2	30 x 60 / 12 x 24	30 x 60 / 12 x 24	60 x 60 / 24 x 24	60 x 60 / 24 x 24			Work size
47 x 47 x 9 mm	47 x 47 x 9 mm	297 x 597 x 9 mm	297 x 597 x 9 mm	597 x 597 x 9 mm	597 x 597 x 9 mm			Surface
structured, matt	structured, matt	structured, matt	structured, matt	structured, matt	structured, matt			m ² - pieces
11.111 sheets	11.111 sheets	5.556	5.556	2.778	2.778			m ² - kg
19.833	19.833	19.907	19.907	20.371	20.371			Bundle - pieces
12 sheets	12 sheets	7	7	3	3			Bundle - m ²
1.080	1.080	1.260	1.260	1.080	1.080			Bundle - kg
21.420	21.420	25.081	25.081	21.999	21.999			Pallet - m ²
32.400	32.400	50.396	50.396	45.356	45.356			Pallet - kg
642.600	642.600	1,003.240	1,003.240	923.958	923.958			Product standard
Bla	Bla	Bla	Bla	Bla	Bla			Slip resistance
R10/A+B	R10/A+B	R10/A+B	R10/A+B	R10/A+B	R10/A+B			Stress group
2	2	2	2	2	2			
435948H		435956H		435964H				light-grey V2
Price gr. C293 (m ²)		Price gr. C116 (m ²)		Price gr. C128 (m ²)				
	435952H		435960H		435968H			light-grey V3
	Price gr. C293 (m ²)		Price gr. C125 (m ²)		Price gr. C140 (m ²)			
435949H		435957H		435965H				mud V2
Price gr. C293 (m ²)		Price gr. C116 (m ²)		Price gr. C128 (m ²)				
	435953H		435961H		435969H			mud V3
	Price gr. C293 (m ²)		Price gr. C125 (m ²)		Price gr. C140 (m ²)			
435950H		435958H		435966H				beige V2
Price gr. C293 (m ²)		Price gr. C116 (m ²)		Price gr. C128 (m ²)				
	435954H		435962H		435970H			beige V3
	Price gr. C293 (m ²)		Price gr. C125 (m ²)		Price gr. C140 (m ²)			
435951H		435959H		435967H				anthracite V2
Price gr. C293 (m ²)		Price gr. C116 (m ²)		Price gr. C128 (m ²)				
	435955H		435963H		435971H			anthracite V3
	Price gr. C293 (m ²)		Price gr. C125 (m ²)		Price gr. C140 (m ²)			



² Glass fibre net on reverse side



Floor Tiles¹

Decoration Elements¹

Stair Tiles^{1/2}

Skirting, rounded¹

60 x 120 cm^{3/4}

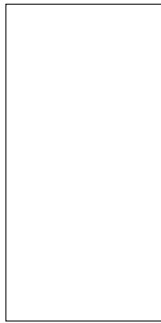

60 x 120 cm^{3/4}

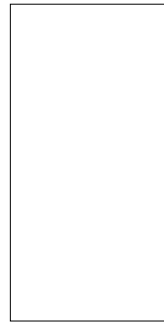

30 x 30 cm



30 x 60 cm



30 x 60 cm

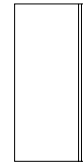

7 x 60 cm



7 x 60 cm



	Stone		Twins Sheet 297 x 297 mm	Stone		Ceppo	
Nom. dim. - cm/in	60 x 120 / 24 x 48	60 x 120 / 24 x 48	30 x 30 / 12 x 12	30 x 60 / 12 x 24	30 x 60 / 12 x 24	7 x 60 / 2 13/16 x 24	7 x 60 / 2 13/16 x 24
Work size	597 x 1197 x 9 mm	597 x 1197 x 9 mm	297 x 297 x 9 mm	297 x 597 x 9 mm	297 x 597 x 9 mm	70 x 597 x 9 mm	70 x 597 x 9 mm
Surface	structured, matt	structured, matt	structured, matt	structured, matt	structured, matt	structured, matt	structured, matt
m ² /m - pieces	1.388/m ²	1.388/m ²	3.333/m	1.667/m	1.667/m	1.667/m	1.667/m
m ² /m - kg	21.132/m ²	21.132/m ²	5.942/m	5.973/m	5.973/m	1.357/m	1.357/m
Bundle - pieces	2	2	4	7	7	15	15
Bundle - m ² /m	1.440 m ²	1.440 m ²	1.200 m	4.199 m	4.199 m	8.998 m	8.998 m
Bundle - kg	30.450	30.450	7.132	25.081	25.081	12.210	12.210
Pallet - m ²	50.432	50.432					
Pallet - kg	1,065.750	1,065.750					
Product standard	Bla	Bla	Bla	Bla	Bla	Bla	Bla
Slip resistance	R10/A+B	R10/A+B	R10/A+B	R10/A+B	R10/A+B		
Stress group	2	2	2	2	2		
	435972H Price gr. C149 (m ²)		435980H Price gr. C517 (pce.)	435984H Price gr. C474 (pce.)		435992H Price gr. C440 (pce.)	
light-grey		435976H Price gr. C152 (m ²)			435988H Price gr. C474 (pce.)		435996H Price gr. C440 (pce.)
light-grey							
mud	435973H Price gr. C149 (m ²)		435981H Price gr. C517 (pce.)	435985H Price gr. C474 (pce.)		435993H Price gr. C440 (pce.)	
mud		435977H Price gr. C152 (m ²)			435989H Price gr. C474 (pce.)		435997H Price gr. C440 (pce.)
beige	435974H Price gr. C149 (m ²)		435982H Price gr. C517 (pce.)	435986H Price gr. C474 (pce.)		435994H Price gr. C440 (pce.)	
beige		435978H Price gr. C152 (m ²)			435990H Price gr. C474 (pce.)		435998H Price gr. C440 (pce.)
anthracite	435975H Price gr. C149 (m ²)		435983H Price gr. C517 (pce.)	435987H Price gr. C474 (pce.)		435995H Price gr. C440 (pce.)	
anthracite		435979H Price gr. C152 (m ²)			435991H Price gr. C474 (pce.)		435999H Price gr. C440 (pce.)

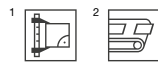

³ High weight only to carry with two persons.

⁴ Please note: special pallet. No return, no exchange.

Rendering

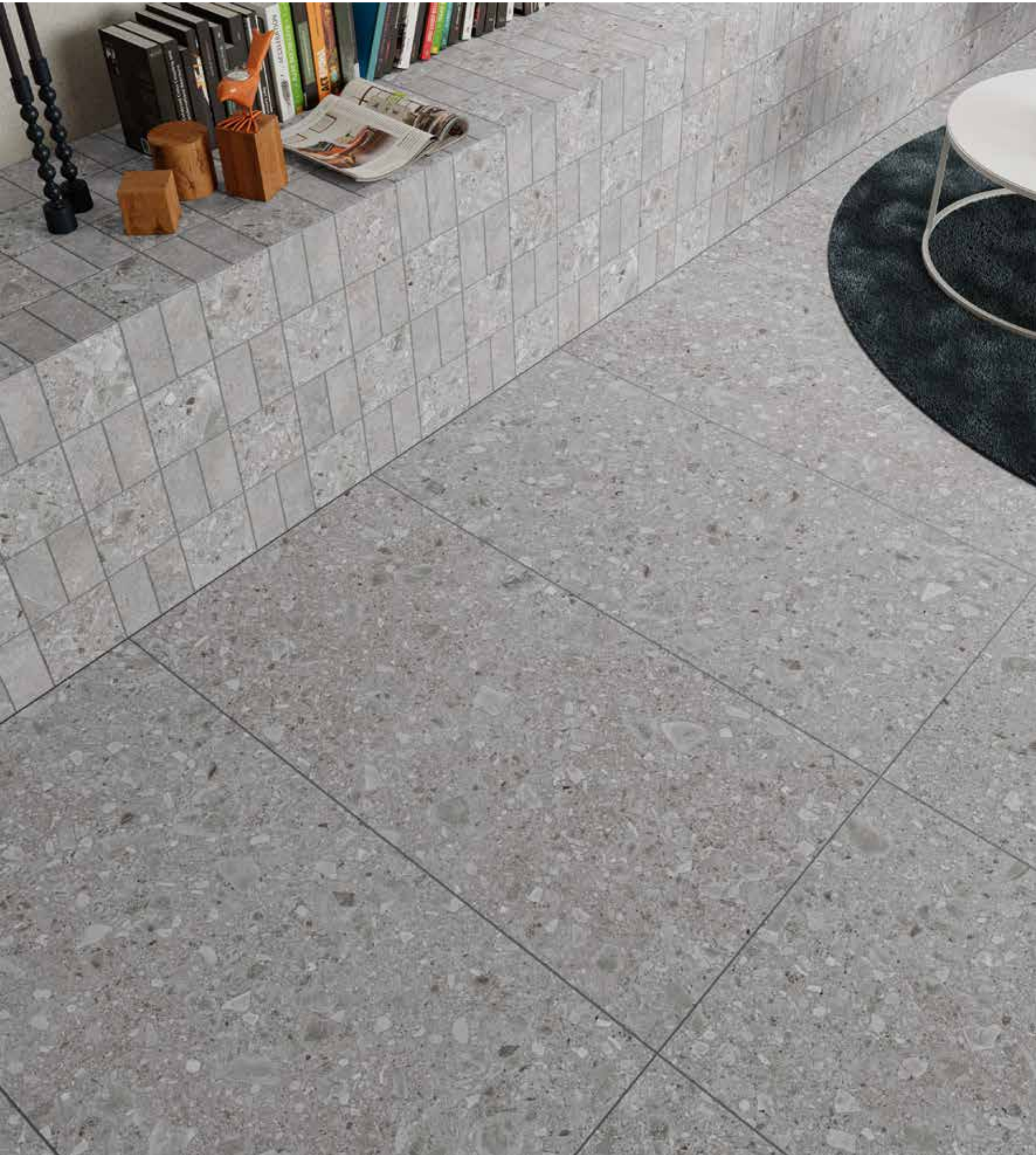





When rooms tell stories

The series Stories is urban to the core: with its cement-like look, timeless grey shades, countless creative options and fascinating opulence. The intentional combination of components of the series reflects the residents' individual preferences: rooms literally tell stories. The floor tiles are convincing thanks to their soft nuances and unadulterated, stone-matt cement characteristics, thus creating an appealingly urban flair. What also makes the series Stories interesting is its two decoration variants: the Tangram cut decor and the Ivy full decor.

Rendering



Wall tile 30 x 60 cm, 12 x 24 in, pearl, structured



Wall tile 30 x 60 cm, 12 x 24 in, soft grey, structured



Wall tile 35 x 100 cm, 14 x 40 in, pearl, structured



Wall tile 35 x 100 cm, 14 x 40 in, soft grey, structured

Decoration elements



Decorative tile Ivy 30 x 60 cm, 12 x 24 in, soft sepia, structured



Decorative tile Ivy 30 x 60 cm, 12 x 24 in, soft concrete, structured



Decorative tile Ivy 35 x 100 cm, 14 x 40 in, soft sepia, structured



Decorative tile Ivy 35 x 100 cm, 14 x 40 in, soft concrete, structured

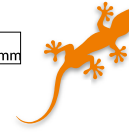

Decoration elements



Mosaic sheet Tangram 30 x 30 cm
12 x 12 in, ivory, structured, R10/A



Mosaic sheet Tangram 30 x 30 cm
12 x 12 in, concrete, structured, R10/A



Mosaic sheet Tangram 30 x 30 cm,
12 x 12 in, sepia, structured, R10/A

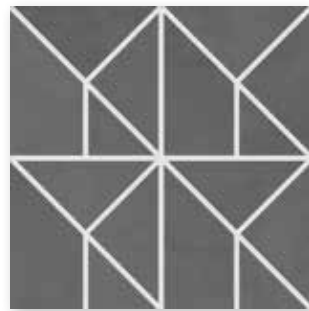

Mosaic sheet Tangram 30 x 30 cm,
12 x 12 in, anthracite, structured, R10/A

Mosaic: glass fibre net on reverse side,
sheet: 297 x 297 mm



R10/A



Made in Germany



ivory



concrete

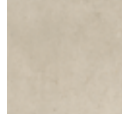

sepia



anthracite



Floor tile 30 x 60 cm, 12 x 24 in, structured, R10/A



Floor tile 60 x 60 cm, 24 x 24 in, structured, R10/A

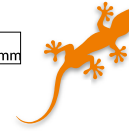

ivory



concrete



sepia



anthracite

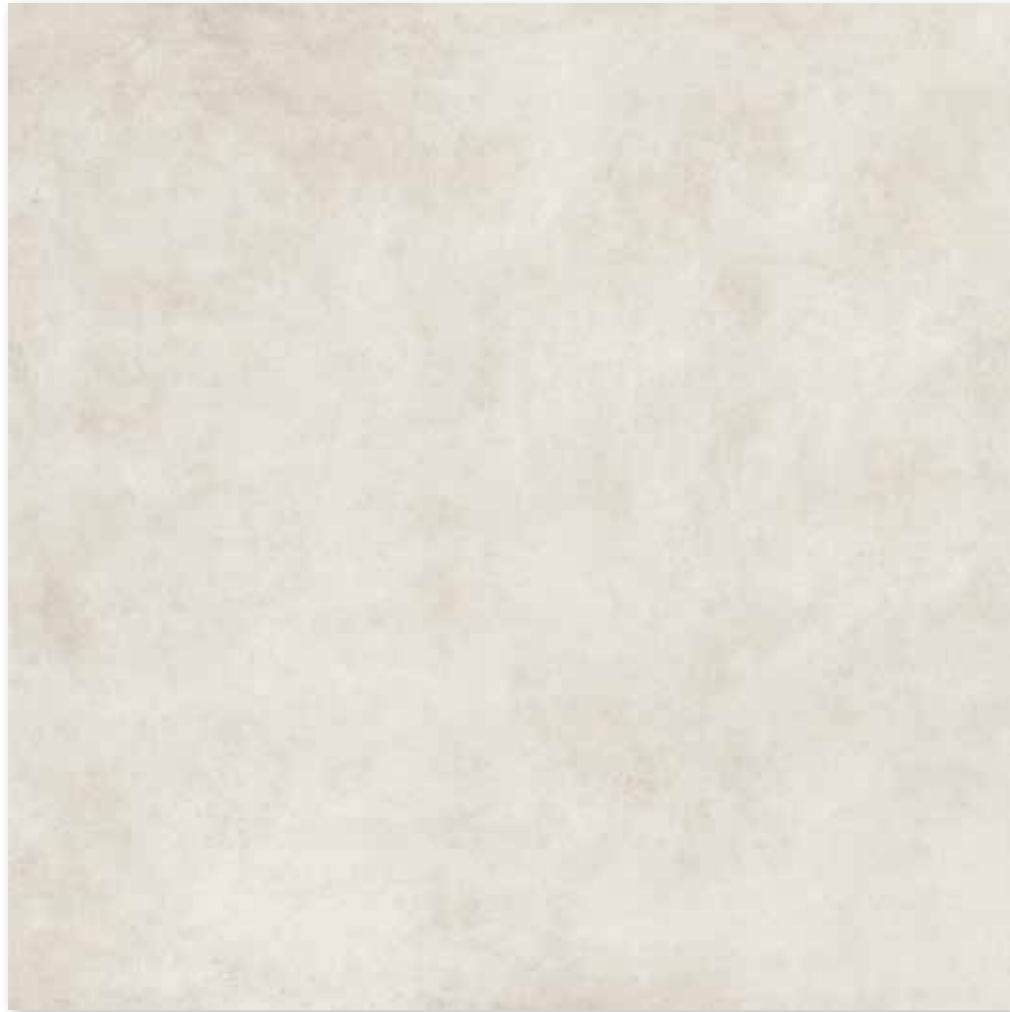

Floor tile 100 x 100 cm, 40 x 40 in, structured, R10/A



Stair tile 30 x 60 cm, 12 x 24 in (with grooves), structured, R10/A



Skirting, rounded 7 x 60 cm, 2 13/16 x 24 in, structured



Mosaic 5 x 5 cm, 2 x 2 in



Mosaic sheet 30 x 30 cm, 12 x 12 in ivory, structured, R10/B



Mosaic sheet 30 x 30 cm, 12 x 12 in concrete, structured, R10/B



Mosaic sheet 30 x 30 cm, 12 x 12 in sepia, structured, R10/B

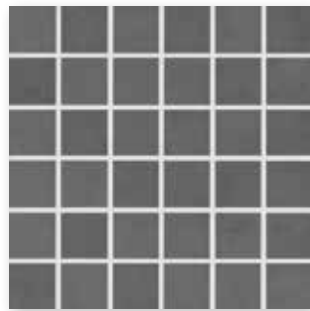

Mosaic sheet 30 x 30 cm, 12 x 12 in anthracite, structured, R10/B



Mosaics glued thermoplastically on back of Agrob Buchtal can be used not only in dry zones but also without any problems in underwater areas (e.g. swimming pools/whirlpools) as well as in permanently wet areas (e.g. pool surrounds/showers).

Patio tiles

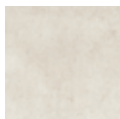

ivory



concrete



sepia



anthracite



Patio tile 60 x 60 cm, 24 x 24 in, structured, R11/B

Wall Tiles

Decoration Elements⁷

Mosaic^{3/4}

30 x 60 cm



35 x 100 cm²

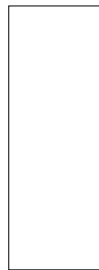

30 x 60 cm



35 x 100 cm²

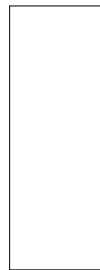

30 x 30 cm^{1/3/5/6}



5 x 5 cm



	Decorative tile Ivy		Decorative tile Ivy		Mosaic sheet Tangram	
	30 x 60 / 12 x 24	35 x 100 / 14 x 40	30 x 60 / 12 x 24	35 x 100 / 14 x 40	30 x 30 / 12 x 12	5 x 5 / 2 x 2
Nom. dim. - cm/in	297 x 597 x 6 mm	347 x 997 x 6 mm	297 x 597 x 6 mm	347 x 997 x 6 mm	297 x 297 x 6 mm	47 x 47 x 6.5 mm
Work size	297 x 597 x 6 mm	347 x 997 x 6 mm	297 x 597 x 6 mm	347 x 997 x 6 mm	297 x 297 x 6 mm	47 x 47 x 6.5 mm
Surface	structured, stone-matt	structured, stone-matt	structured, stone-matt	structured, stone-matt	structured, matt	structured, matt
m ² /m - pieces	5.556/m ²	2.857/m ²	5.556/m ²	2.857/m ²	3.333 sheets/m	11 sheets/m ²
m ² /m - kg	10.279/m ²	10.108/m ²	10.279/m ²	10.108/m ²	3.776/m	12.331/m ²
Bundle - pieces	13	5	13	5	3 sheets	11 sheets
Bundle - m ² /m	2.340 m ²	1.750 m ²	2.340 m ²	1.750 m ²	0.900 m	1.000 m ²
Bundle - kg	24.050	17.690	24.050	17.690	3.399	12.331
Pallet - m ²	112.311	70.004	112.311	70.004		64.000
Pallet - kg	1,154.400	707.600	1,154.400	707.600		789.184
Product standard	BIII	BIII	BIII	BIII	Bla	Bla
Slip resistance					R10/A	R10/B
Stress group					1	1
pearl <input type="checkbox"/> V2	203431H Price gr. W90 (m ²)	363352H Price gr. W132 (m ²)				
soft grey <input type="checkbox"/> V2	203433H Price gr. W90 (m ²)	363353H Price gr. W132 (m ²)				
soft sepia <input type="checkbox"/> V3			203432H Price gr. W102 (m ²)	363354H Price gr. W144 (m ²)		
soft concrete <input type="checkbox"/> V3			203434H Price gr. W102 (m ²)	363355H Price gr. W144 (m ²)		
ivory <input type="checkbox"/> V2					363356 Price gr. W501 (pce.)	432335H Price gr. W177 (m ²)
concrete <input type="checkbox"/> V2					363357 Price gr. W501 (pce.)	432336H Price gr. W177 (m ²)
sepia <input type="checkbox"/> V2					363358 Price gr. W501 (pce.)	432337H Price gr. W177 (m ²)
anthracite <input type="checkbox"/> V2					363359 Price gr. W501 (pce.)	432338H Price gr. W177 (m ²)

- 1
- 2
- 3
- 4
- 5 without Hytect coating; with Protecta upgrading
- 6 Glass fibre net on reverse side
- 7 Decoration elements only available in full boxes.

Floor Tiles¹

30 x 60 cm



60 x 60 cm

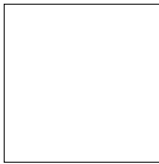

100 x 100 cm^{3/4/5/6}

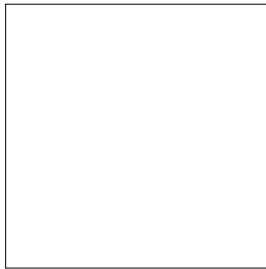

Stair Tile^{1/2}

30 x 60 cm



Skirting, rounded¹

7 x 60 cm



Patio Tile^{1/5}

60 x 60 cm

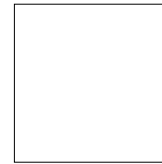

30 x 60 / 12 x 24	60 x 60 / 24 x 24	100 x 100 / 40 x 40	30 x 60 / 12 x 24	7 x 60 / 2 13/16 x 24	60 x 60 / 24 x 24	Nom. dim. - cm/in
297 x 597 x 9 mm	597 x 597 x 9 mm	997 x 997 x 6 mm	297 x 597 x 9 mm	70 x 597 x 9 mm	597 x 597 x 20 mm	Work size
structured, matt	structured, matt	structured, matt	structured, matt	structured, matt	structured, matt	Surface
5.556/m ²	2.778/m ²	1.000/m ²	1.667/m	1.667/m	2.778/m ²	m ² /m - pieces
19.907/m ²	20.371/m ²	14.100/m ²	5.973/m	1.357/m	45.273/m ²	m ² /m - kg
7	3	2	7	15	2	Bundle - pieces
1.260 m ²	1.080 m ²	2.000 m ²	4.199 m	8.998 m	0.720 m ²	Bundle - m ² /m
25.081	21.999	28.200	25.081	12.210	32.594	Bundle - kg
50.396	45.356	50.000			21.598	Pallet - m ²
1,003.240	923.958	705.000			977.820	Pallet - kg
Bla	Bla	Bla	Bla	Bla	Bla	Product standard
R10/A	R10/A	R10/A	R10/A	R10/A	R11/B	Slip resistance
2	2	1	2	2	4	Stress group
431630H	431634H	432323	<i>431638H</i>	431642H	434986H	ivory <input type="checkbox"/> V2
Price gr. W111 (m ²)	Price gr. W123 (m ²)	Price gr. W156 (m ²)	Price gr. <i>W473</i> (pce.)	Price gr. W439 (pce.)	Price gr. W198 (m ²)	
431632H	431636H	432324	<i>431640H</i>	431644H	434987H	concrete <input type="checkbox"/> V2
Price gr. W111 (m ²)	Price gr. W123 (m ²)	Price gr. W156 (m ²)	Price gr. <i>W473</i> (pce.)	Price gr. W439 (pce.)	Price gr. W198 (m ²)	
431631H	431635H	432325	<i>431639H</i>	431643H	434988H	sepia <input type="checkbox"/> V2
Price gr. W111 (m ²)	Price gr. W123 (m ²)	Price gr. W156 (m ²)	Price gr. <i>W473</i> (pce.)	Price gr. W439 (pce.)	Price gr. W198 (m ²)	
431633H	431637H	432326	<i>431641H</i>	431645H	434989H	anthracite <input type="checkbox"/> V2
Price gr. W111 (m ²)	Price gr. W123 (m ²)	Price gr. W156 (m ²)	Price gr. <i>W473</i> (pce.)	Price gr. W439 (pce.)	Price gr. W198 (m ²)	

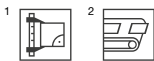

- ¹ without Hytect coating; with Protecta upgrading
- ² Please note: special pallet. No return, no exchange.
- ³ High weight only to carry with two persons.
- ⁴ Suitable for the use in areas with stress group 1.







New naturalness

Strata reinterprets natural colors. The new ceramic series from Agrob Buchtal was developed together with the color designer Peter Zoernack. Following the example of nature, color shades were sought which correspond to a ceramic, stone material. The result is two color families with eight harmonious colors. With its nuanced color range, ceramic implementation and variety of formats, Strata offers architects and planners a useful modular system for timeless room designs. Technically sophisticated, it satisfies various practical requirements in indoor and outdoor areas.

Rendering / Architect: VSBL, Belgrad, Serbia



R10/A+B



quarz



Oblong format 10 x 60 cm, 4 x 24 in, smooth, R10/A+B



stone

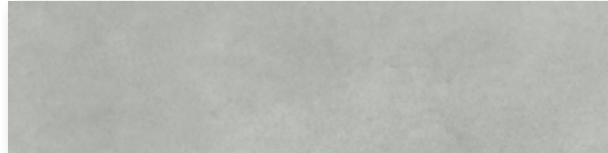

Oblong format 15 x 60 cm, 6 x 24 in, smooth, R10/A+B



lava



volcano



Floor tile 30 x 60 cm, 12 x 24 in, smooth, R10/A+B
Floor tile 30 x 60 cm, 12 x 24 in, smooth, R11/B



loam



Floor tile 30 x 30 cm, 12 x 12 in, smooth, R10/A+B

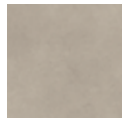

clay



lime



Floor tile 60 x 60 cm, 24 x 24 in, smooth, R10/A+B

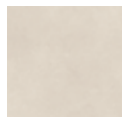

pumice



Floor tile 60 x 120 cm, 24 x 48 in, smooth, R10/A+B



Stair tile (with grooves) 30 x 60 cm, 12 x 24 in, smooth, R10/A+B

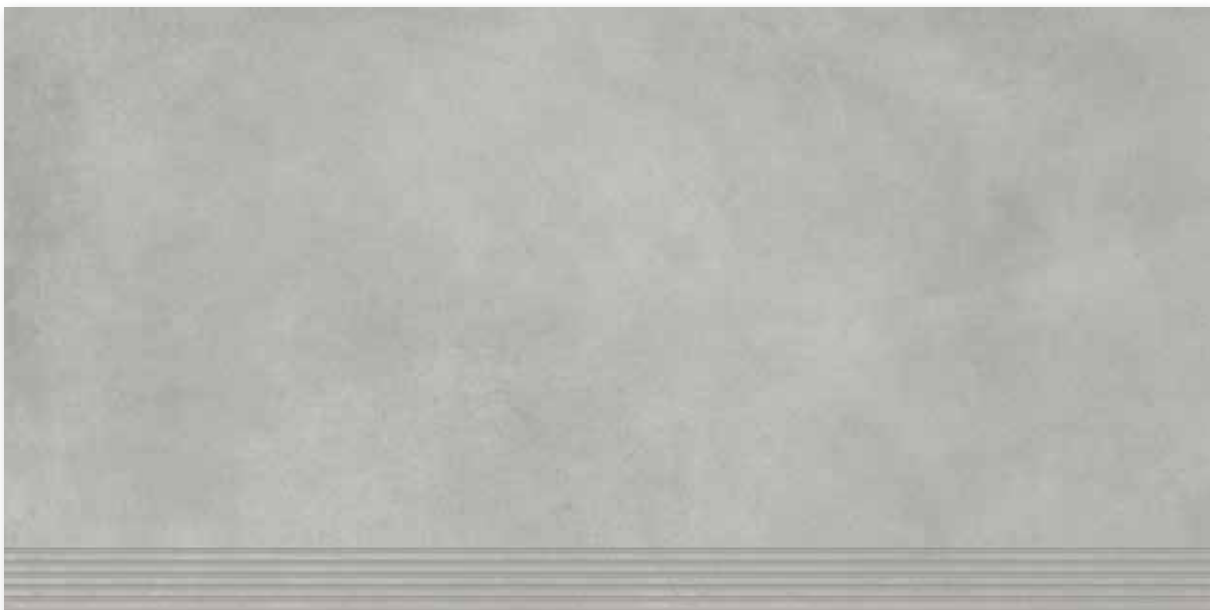

Stair tile (with grooves) 60 x 120 cm, 24 x 48 in, smooth, R10/A+B



R10/A+B



quarz



Skirting, rounded 7 x 60 cm, 2 13/16 x 24 in, smooth



stone

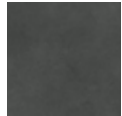

lava



Stair safety boarder 4 x 60 cm, 1 5/8 x 24 in, smooth, R10/A+B



volcano



loam



Stair safety boarder 7.2 x 60 cm, 2 7/8 x 24 in, smooth, R10/A+B



clay



lime



Stair safety boarder 7.2 x 120 cm, 2 7/8 x 48 cm in, smooth, R10/A+B



pumice



Stair safety boarder with bevel 7.2 x 145 cm, smooth, R10/A+B



Stair tile with bevel 31 x 145 cm, 12 13/64 x 57 in, smooth, R10/A+B



Stair tile with bevel and grooves 31 x 145 cm, 12 13/64 x 57 in, smooth, R10/A+B



Riser 28 x 145 cm, 11 x 57 in, smooth, R10/A+B



Cove skirting 10 x 30 cm, 4 x 12 in, smooth



Cove skirting 10 x 60 cm, 4 x 24 in, smooth

Mosaic 5 x 5 cm, 2 x 2 in

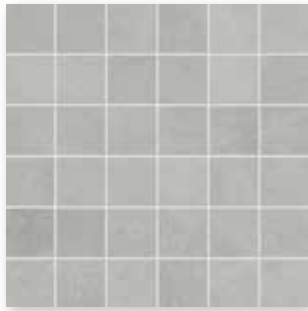

Mosaic sheet 30 x 30 cm, 12 x 12 in quartz, smooth, R10/A+B

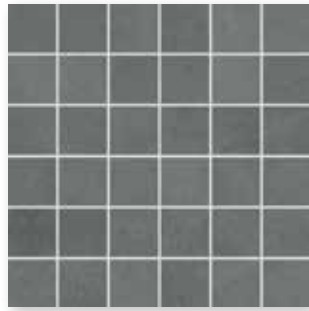

Mosaic sheet 30 x 30 cm, 12 x 12 in stone, smooth, R10/A+B

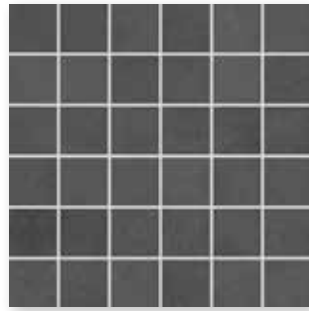

Mosaic sheet 30 x 30 cm, 12 x 12 in lava, smooth, R10/A+B

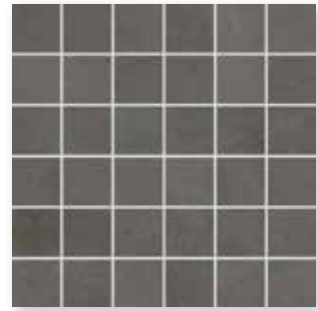

Mosaic sheet 30 x 30 cm, 12 x 12 in volcano, smooth, R10/A+B

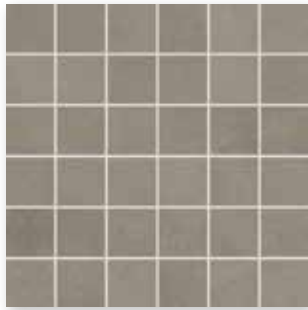

Mosaic sheet 30 x 30 cm, 12 x 12 in loam, smooth, R10/A+B

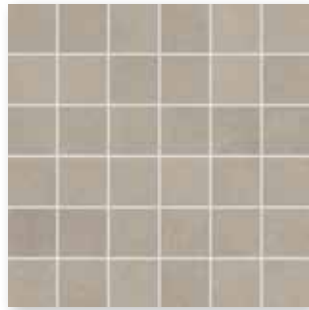

Mosaic sheet 30 x 30 cm, 12 x 12 in clay, smooth, R10/A+B

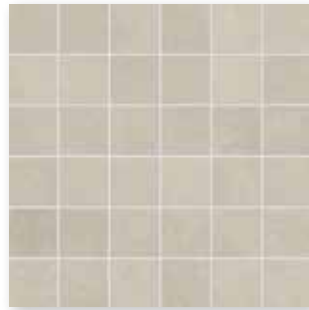

Mosaic sheet 30 x 30 cm, 12 x 12 in lime, smooth, R10/A+B

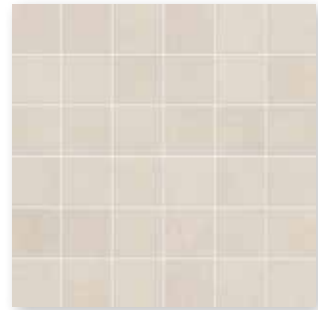

Mosaic sheet 30 x 30 cm, 12 x 12 in pumice, smooth, R10/A+B

Mosaic sheet Edge 30 x 30 cm, 12 x 12 in



Mosaic sheet 30 x 30 cm, 12 x 12 in quartz, smooth, R10/A+B

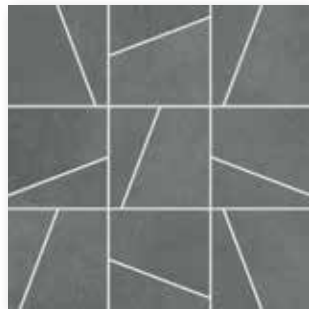

Mosaic sheet 30 x 30 cm, 12 x 12 in stone, smooth, R10/A+B

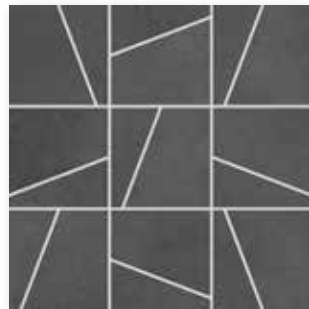

Mosaic sheet 30 x 30 cm, 12 x 12 in lava, smooth, R10/A+B

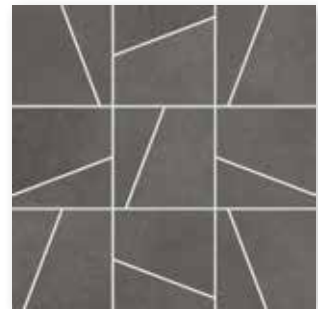

Mosaic sheet 30 x 30 cm, 12 x 12 in volcano, smooth, R10/A+B



Mosaic sheet 30 x 30 cm, 12 x 12 in loam, smooth, R10/A+B



Mosaic sheet 30 x 30 cm, 12 x 12 in clay, smooth, R10/A+B



Mosaic sheet 30 x 30 cm, 12 x 12 in lime, smooth, R10/A+B



Mosaic sheet 30 x 30 cm, 12 x 12 in pumice, smooth, R10/A+B

Mosaic: glass fibre net on reverse side, sheet: 297 x 297 mm

Mosaic^{1/3}

Floor Tiles¹

5 x 5 cm



10 x 10 cm



10 x 60 cm²



15 x 60 cm²



30 x 30 cm



30 x 60 cm

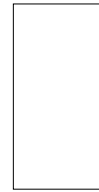

30 x 60 cm



Sheet: 297 x 297 mm

Mosaic Edge

Sheet: 297 x 297 mm

Oblong format

Oblong format

5 x 5 / 2 x 2	10 x 10 / 4 x 4	10 x 60 / 4 x 24	15 x 60 / 6 x 24	30 x 30 / 12 x 12	30 x 60 / 12 x 24	30 x 60 / 12 x 24	Nom. dim. - cm/in
47 x 47 x 8 mm	97 x 97 x 8 mm	97 x 597 x 8 mm	147 x 597 x 8 mm	297 x 297 x 8 mm	297 x 597 x 8 mm	297 x 597 x 8 mm	Work size
smooth, matt	smooth, matt	smooth, matt	smooth, matt	smooth, matt	smooth, matt	smooth, matt	Surface
11.111 sheets/m ²	3.333 sheets/m	16.667/m ²	11.111/m ²	11.111/m ²	5.556/m ²	5.556/m ²	m ² - pieces
16.389/m ²	4.823/m	17.417/m ²	17.411/m ²	17.222/m ²	17.696/m ²	17.696/m ²	m ² - kg
14 sheets	3 sheets	18	14	14	7	7	Bundle - pieces
1.260 m ²	0.900 m	1.080 m ²	1.260 m ²	1.260 m ²	1.260 m ²	1.260 m ²	Bundle - m ² /m
20.650	4.341	18.810	21.938	21.708	22.295	22.295	Bundle - kg
37.800		43.199	50.401	60.481	50.396	50.396	Pallet - m ²
619.500			877.520	1,041.600	891.800	891.800	Pallet - kg
Bla	Bla	Bla	Bla	Bla	Bla	Bla	Product standard
R10/A+B	R10/A+B	R10/A+B	R10/A+B	R10/A+B	R10/A+B	R11/B	Slip resistance
2	2		2	2	2	2	Stress group
435380H	435372H	<i>435397H</i>	<i>435409H</i>	435417H	435428H	435301H	quartz <input type="checkbox"/> V2
Price gr. A265 (m ²)	Price gr. A506 (pce.)	Price gr. <i>A199</i> (m ²)	Price gr. <i>A199</i> (m ²)	Price gr. A61 (m ²)	Price gr. A115 (m ²)	Price gr. A115 (m ²)	
435381H	435373H	<i>435398H</i>	<i>435410H</i>	435418H	435429H	435302H	stone <input type="checkbox"/> V2
Price gr. A265 (m ²)	Price gr. A506 (pce.)	Price gr. <i>A199</i> (m ²)	Price gr. <i>A199</i> (m ²)	Price gr. A61 (m ²)	Price gr. A115 (m ²)	Price gr. A115 (m ²)	
435382H	435374H	<i>435399H</i>	<i>435411H</i>	435419H	435430H	435303H	lava <input type="checkbox"/> V2
Price gr. A265 (m ²)	Price gr. A506 (pce.)	Price gr. <i>A199</i> (m ²)	Price gr. <i>A199</i> (m ²)	Price gr. A61 (m ²)	Price gr. A115 (m ²)	Price gr. A115 (m ²)	
435383H	435375H	<i>435400H</i>	<i>435412H</i>	435420H	435431H	435304H	volcano <input type="checkbox"/> V2
Price gr. A265 (m ²)	Price gr. A506 (pce.)	Price gr. <i>A199</i> (m ²)	Price gr. <i>A199</i> (m ²)	Price gr. A61 (m ²)	Price gr. A115 (m ²)	Price gr. A115 (m ²)	
435384H	435376H	<i>435401H</i>	<i>435413H</i>	435421H	435432H	435305H	loam <input type="checkbox"/> V2
Price gr. A265 (m ²)	Price gr. A506 (pce.)	Price gr. <i>A199</i> (m ²)	Price gr. <i>A199</i> (m ²)	Price gr. A61 (m ²)	Price gr. A115 (m ²)	Price gr. A115 (m ²)	
435385H	435377H	<i>435402H</i>	<i>435414H</i>	435422H	435433H	435306H	clay <input type="checkbox"/> V2
Price gr. A265 (m ²)	Price gr. A506 (pce.)	Price gr. <i>A199</i> (m ²)	Price gr. <i>A199</i> (m ²)	Price gr. A61 (m ²)	Price gr. A115 (m ²)	Price gr. A115 (m ²)	
435386H	435378H	<i>435403H</i>	<i>435415H</i>	435423H	435434H	435307H	lime <input type="checkbox"/> V2
Price gr. A265 (m ²)	Price gr. A506 (pce.)	Price gr. <i>A199</i> (m ²)	Price gr. <i>A199</i> (m ²)	Price gr. A61 (m ²)	Price gr. A115 (m ²)	Price gr. A115 (m ²)	
435387H	435379H	<i>435404H</i>	<i>435416H</i>	435424H	435435H	435308H	pumice <input type="checkbox"/> V2
Price gr. A265 (m ²)	Price gr. A506 (pce.)	Price gr. <i>A199</i> (m ²)	Price gr. <i>A199</i> (m ²)	Price gr. A61 (m ²)	Price gr. A115 (m ²)	Price gr. A115 (m ²)	



³ Glass fibre net on reverse side



Floor Tiles¹

Stair Tiles with grooves^{1/2}

Stair Tile with bevel^{2/4/5}

Stair Tile with bevel & grooves^{2/4/5}

Riser^{2/4}

60 x 60 cm

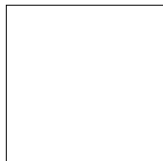

60 x 120 cm³



30 x 60 cm

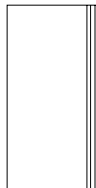

60 x 120 cm³

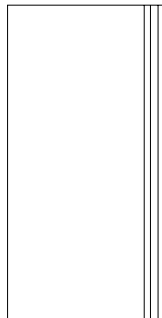

31 x 145 cm

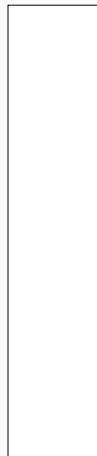

31 x 145 cm

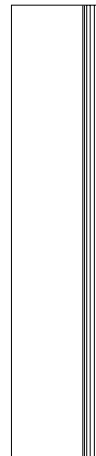

28 x 145 cm



Nom. dim. - cm/in	60 x 60 / 24 x 24	60 x 120 / 24 x 48	30 x 60 / 12 x 24	60 x 120 / 24 x 48	31 x 145 / 12 3/8 x 58	31 x 145 / 12 3/8 x 58	28 x 145 / 11 3/16 x 58
Work size	597 x 597 x 8 mm	597 x 1197 x 8 mm	297 x 597 x 8 mm	597 x 1197 x 8 mm	307 x 1447 x 10.5 mm	307 x 1447 x 10.5 mm	280 x 1447 x 10.5 mm
Surface	smooth, matt	smooth, matt	smooth, matt	smooth, matt	smooth, matt	smooth, matt	smooth, matt
m ² /m - pieces	2,778/m ²	1.388/m ²	1.667/m	0.833/m	0.690/m	0.690/m	0.690/m
m ² /m - kg	18.107/m ²	18.784/m ²	5.310/m	11.273/m	7.480/m	7.480/m	6.716/m
Bundle - pieces	4	2	7	2	2	2	2
Bundle - m ² /m	1.440 m ²	1.440 m ²	4.200 m	2.401 m	2.899 m	2.899 m	2.899 m
Bundle - kg	26.072	27.066	22.295	27.066	21.682	21.682	19.466
Pallet - m ²	51.836	50.432					
Pallet - kg	938.592	947.310					
Product standard	Bla	Bla	Bla	Bla	Ala	Ala	Ala
Slip resistance	R10/A+B	R10/A+B	R10/A+B	R10/A+B	R10/A+B	R10/A+B	R10/A+B
Stress group	2	2	2	2	2	2	2
quartz	435436H Price gr. A127 (m ²)	435452H Price gr. A124 (m ²)	435460H Price gr. A465 (pce.)	435452H-TF Price gr. A593 (pce.)	435468H Price gr. A560 (pce.)	435468H-TF Price gr. A577 (pce.)	435476H Price gr. A528 (pce.)
stone	435437H Price gr. A127 (m ²)	435453H Price gr. A124 (m ²)	435461H Price gr. A465 (pce.)	435453H-TF Price gr. A593 (pce.)	435469H Price gr. A560 (pce.)	435469H-TF Price gr. A577 (pce.)	435477H Price gr. A528 (pce.)
lava	435438H Price gr. A127 (m ²)	435454H Price gr. A124 (m ²)	435462H Price gr. A465 (pce.)	435454H-TF Price gr. A593 (pce.)	435470H Price gr. A560 (pce.)	435470H-TF Price gr. A577 (pce.)	435478H Price gr. A528 (pce.)
volcano	435439H Price gr. A127 (m ²)	435455H Price gr. A124 (m ²)	435463H Price gr. A465 (pce.)	435455H-TF Price gr. A593 (pce.)	435471H Price gr. A560 (pce.)	435471H-TF Price gr. A577 (pce.)	435479H Price gr. A528 (pce.)
loam	435440H Price gr. A127 (m ²)	435456H Price gr. A124 (m ²)	435464H Price gr. A465 (pce.)	435456H-TF Price gr. A593 (pce.)	435472H Price gr. A560 (pce.)	435472H-TF Price gr. A577 (pce.)	435480H Price gr. A528 (pce.)
clay	435441H Price gr. A127 (m ²)	435457H Price gr. A124 (m ²)	435465H Price gr. A465 (pce.)	435457H-TF Price gr. A593 (pce.)	435473H Price gr. A560 (pce.)	435473H-TF Price gr. A577 (pce.)	435481H Price gr. A528 (pce.)
lime	435442H Price gr. A127 (m ²)	435458H Price gr. A124 (m ²)	435466H Price gr. A465 (pce.)	435458H-TF Price gr. A593 (pce.)	435474H Price gr. A560 (pce.)	435474H-TF Price gr. A577 (pce.)	435482H Price gr. A528 (pce.)
pumice	435443H Price gr. A127 (m ²)	435459H Price gr. A124 (m ²)	435467H Price gr. A465 (pce.)	435459H-TF Price gr. A593 (pce.)	435475H Price gr. A560 (pce.)	435475H-TF Price gr. A577 (pce.)	435483H Price gr. A528 (pce.)

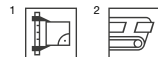

³ High weight only to carry with two persons.
⁴ Only rectified on the two short sides. The long side can not be rectified.
⁵ For details, refer to page 538

Stair Edges^{1/2}

Stair Edges with bevel^{2/3/4}

4 x 60 cm



7,2 x 60 cm



7,2 x 120 cm



7,2 x 145 cm



			4 x 60 / 1 5/8 x 24	7.2 x 60 / 2 7/8 x 24	7.2 x 120 / 2 7/8 x 48	7.2 x 145 / 2 7/8 x 58	Nom. dim. - cm/in
			40 x 597 x 8 mm	72 x 597 x 8 mm	72 x 1197 x 8 mm	72 x 1447 x 10.5 mm	Work size
			smooth, matt	smooth, matt	smooth, matt	smooth, matt	Surface
			1.667	1.667	0.833	0.690	m - pieces
			0.697	1.254	1.353	1.737	m - kg
			9	18	10	10	Bundle - pieces
			5.399	10.7893	12.005	14.493	Bundle - m
			3.762	13.536	16.240	25.180	Bundle - kg
			Bla	Bla	Bla	Ala	Product standard
			R10/A+B	R10/A+B	R10/A+B	R10/A+B	Slip resistance
			2	2	2	2	Stress group
			435484H	435428H-TK	435452H-TK	435468H-TK	quartz <input type="checkbox"/> V2
			Price gr. A458 (pce.)	Price gr. A458 (pce.)	Price gr. A511 (pce.)	Price gr. A539 (pce.)	
			435485H	435429H-TK	435453H-TK	435469H-TK	stone <input type="checkbox"/> V2
			Price gr. A458 (pce.)	Price gr. A458 (pce.)	Price gr. A511 (pce.)	Price gr. A539 (pce.)	
			435486H	435430H	435454H-TK	435470H-TK	lava <input type="checkbox"/> V2
			Price gr. A458 (pce.)	Price gr. A458 (pce.)	Price gr. A511 (pce.)	Price gr. A539 (pce.)	
			435487H	435431H-TK	435455H-TK	435471H-TK	volcano <input type="checkbox"/> V2
			Price gr. A458 (pce.)	Price gr. A458 (pce.)	Price gr. A511 (pce.)	Price gr. A539 (pce.)	
			435488H	435432H-TK	435456H-TK	435472H-TK	loam <input type="checkbox"/> V2
			Price gr. A458 (pce.)	Price gr. A458 (pce.)	Price gr. A511 (pce.)	Price gr. A539 (pce.)	
			435489H	435433H-TK	435457H-TK	435473H-TK	clay <input type="checkbox"/> V2
			Price gr. A458 (pce.)	Price gr. A458 (pce.)	Price gr. A511 (pce.)	Price gr. A539 (pce.)	
			435490H	435434H-TK	435458H-TK	435474H-TK	lime <input type="checkbox"/> V2
			Price gr. A458 (pce.)	Price gr. A458 (pce.)	Price gr. A511 (pce.)	Price gr. A539 (pce.)	
			435491H	435435H-TK	435459H-TK	435475H-TK	pumice <input type="checkbox"/> V2
			Price gr. A458 (pce.)	Price gr. A458 (pce.)	Price gr. A511 (pce.)	Price gr. A539 (pce.)	



³ Rectified only on the two short sides. The long side can not be rectified.

⁴ For details, refer to page 538



Skirting, rounded¹

Cove Skirting²

7 x 60 cm

10 x 30 cm

10 x 60 cm



Nom. dim. - cm/in	7 x 60 / 2 13/16 x 24	10 x 30 / 4 x 12	10 x 60 / 4 x 24				
Work size	70 x 597 x 8 mm	102 x 297 x 9 mm	102 x 597 x 9 mm				
Surface	smooth, matt	smooth, matt	smooth, matt				
m - pieces	1.667	3.333	1.667				
m - kg	1.207	1.776	2.000				
Bundle - pieces	15	16	16				
Bundle - m	8.998	4.800	9.598				
Bundle - kg	10.860	8.528	17.072				
Pallet - m ²							
Pallet - kg							
Product standard	Bla	Bla	Bla				
Slip resistance		R10/A+B	R10/A+B				
Stress group							
quartz <input type="checkbox"/>	435492H Price gr. A425 (pce.)	435309H Price gr. A422 (pce.)	435317H Price gr. A441 (pce.)				
stone <input type="checkbox"/>	435493H Price gr. A425 (pce.)	435310H Price gr. A422 (pce.)	435318H Price gr. A441 (pce.)				
lava <input type="checkbox"/>	435494H Price gr. A425 (pce.)	435311H Price gr. A422 (pce.)	435319H Price gr. A441 (pce.)				
volcano <input type="checkbox"/>	435495H Price gr. A425 (pce.)	435312H Price gr. A422 (pce.)	435320H Price gr. A441 (pce.)				
loam <input type="checkbox"/>	435496H Price gr. A425 (pce.)	435313H Price gr. A422 (pce.)	435321H Price gr. A441 (pce.)				
clay <input type="checkbox"/>	435497H Price gr. A425 (pce.)	435314H Price gr. A422 (pce.)	435322H Price gr. A441 (pce.)				
lime <input type="checkbox"/>	435498H Price gr. A425 (pce.)	435315H Price gr. A422 (pce.)	435323H Price gr. A441 (pce.)				
pumice <input type="checkbox"/>	435499H Price gr. A425 (pce.)	435316H Price gr. A422 (pce.)	435324H Price gr. A441 (pce.)				



² Color deviations compared to the adjoining covering due to production are no reason for complaint in case of horizontal laying.

Rendering







Urban, casual, cool

Streetlife Metallic translates the good feeling of lived-in surfaces into an expressive tile design. The protagonists of the series: rust surfaces with streaks, traces of oxidation and radiant vibrancy. In addition, a soft, cloudy, iridescent look reminiscent of brushed metal surfaces. In Streetlife Metallic, the two form a powerful combination which lends a timeless urban feel to open-plan living concepts and modern loft architecture. Intense, metallic colors provide a stage especially for real wood, shimmering fabrics and metal elements. With formats of 60 x 60 and 60 x 120 cm and a thickness of 10.5 mm, this timeless floor covering also qualifies for public applications such as e.g. office spaces or retail design.

Rendering



rust

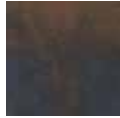

rust blue

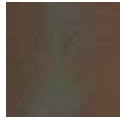

rust green

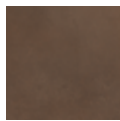

terra

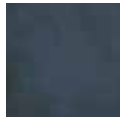

blue steel



rusty green



Floor tile 60 x 60 cm, 24 x 24 in, structured, R10



Floor tile 60 x 120 cm, 24 x 48 in, structured, R10



Stair tile 30 x 120 cm, 12 x 48 in (with grooves), structured, R10



Skirting, cut 6 x 60 cm, 2 3/8 x 24 in, structured

Floor Tiles¹

Stair Tile^{1/2}

Skirting,
cut¹

60 x 60 cm

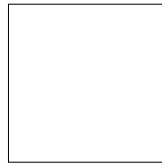

60 x 120 cm³



30 x 120 cm



6 x 60 cm



	B700HK	B770HK	B729HK	B710HK	
	60 x 60 / 24 x 24	60 x 120 / 24 x 48	30 x 120 / 12 x 48	6 x 60 / 2 3/8 x 24	Model number
	597 x 597 x 10.5 mm	597 x 1197 x 10.5 mm	297 x 1197 x 10.5 mm	60 x 597 x 10.5 mm	Nom. dim. - cm/in
	structured, matt	structured, matt	structured, matt	structured, matt	Work size
	2.778/m ²	1.389/m ²	0.833/m	1.667/m	Surface
	23.335/m ²	23.821/m ²	6.427/m	1.445/m	m ² /m - pieces
	3	2	3	24	m ² /m - kg
	1.080 m ²	1.440 m ²	3.601 m	14.397 m	Bundle - pieces
	25.200	34.300	23.148	20.808	Bundle - m ² /m
	32.397	30.259			Bundle - kg
	756.000	720.300			Pallet - m ²
	Ala	Ala	Ala	Ala	Pallet - kg
	R10/A+B	R10/A+B	R10/A+B		Product standard
	2	2	2	2	Slip resistance
	8823-B700HK	8823-B770HK	<i>8823-B729HK</i>	8823-B710HK	Stress group
	Price gr. A154 (m ²)	Price gr. A178 (m ²)	Price gr. <i>A560</i> (pce.)	Price gr. A438 (pce.)	rust <input type="checkbox"/> V4
	8824-B700HK	8824-B770HK	<i>8824-B729HK</i>	8824-B710HK	rust-blue <input type="checkbox"/> V4
	Price gr. A154 (m ²)	Price gr. A178 (m ²)	Price gr. <i>A560</i> (pce.)	Price gr. A438 (pce.)	rust-green <input type="checkbox"/> V4
	8825-B700HK	8825-B770HK	<i>8825-B729HK</i>	8825-B710HK	terra <input type="checkbox"/> V2
	Price gr. A154 (m ²)	Price gr. A178 (m ²)	Price gr. <i>A560</i> (pce.)	Price gr. A438 (pce.)	blue steel <input type="checkbox"/> V2
	8826-B700HK	8826-B770HK	<i>8826-B729HK</i>	8826-B710HK	cooper green <input type="checkbox"/> V2
	Price gr. A154 (m ²)	Price gr. A178 (m ²)	Price gr. <i>A560</i> (pce.)	Price gr. A438 (pce.)	
	8827-B700HK	8827-B770HK	<i>8827-B729HK</i>	8827-B710HK	
	Price gr. A154 (m ²)	Price gr. A178 (m ²)	Price gr. <i>A560</i> (pce.)	Price gr. A438 (pce.)	
	8828-B700HK	8828-B770HK	<i>8828-B729HK</i>	8828-B710HK	
	Price gr. A154 (m ²)	Price gr. A178 (m ²)	Price gr. <i>A560</i> (pce.)	Price gr. A438 (pce.)	

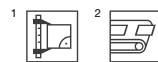

³ High weight only to carry with two persons.



Available as of the 2nd quarter of 2025 (exception: the articles in the color rust).



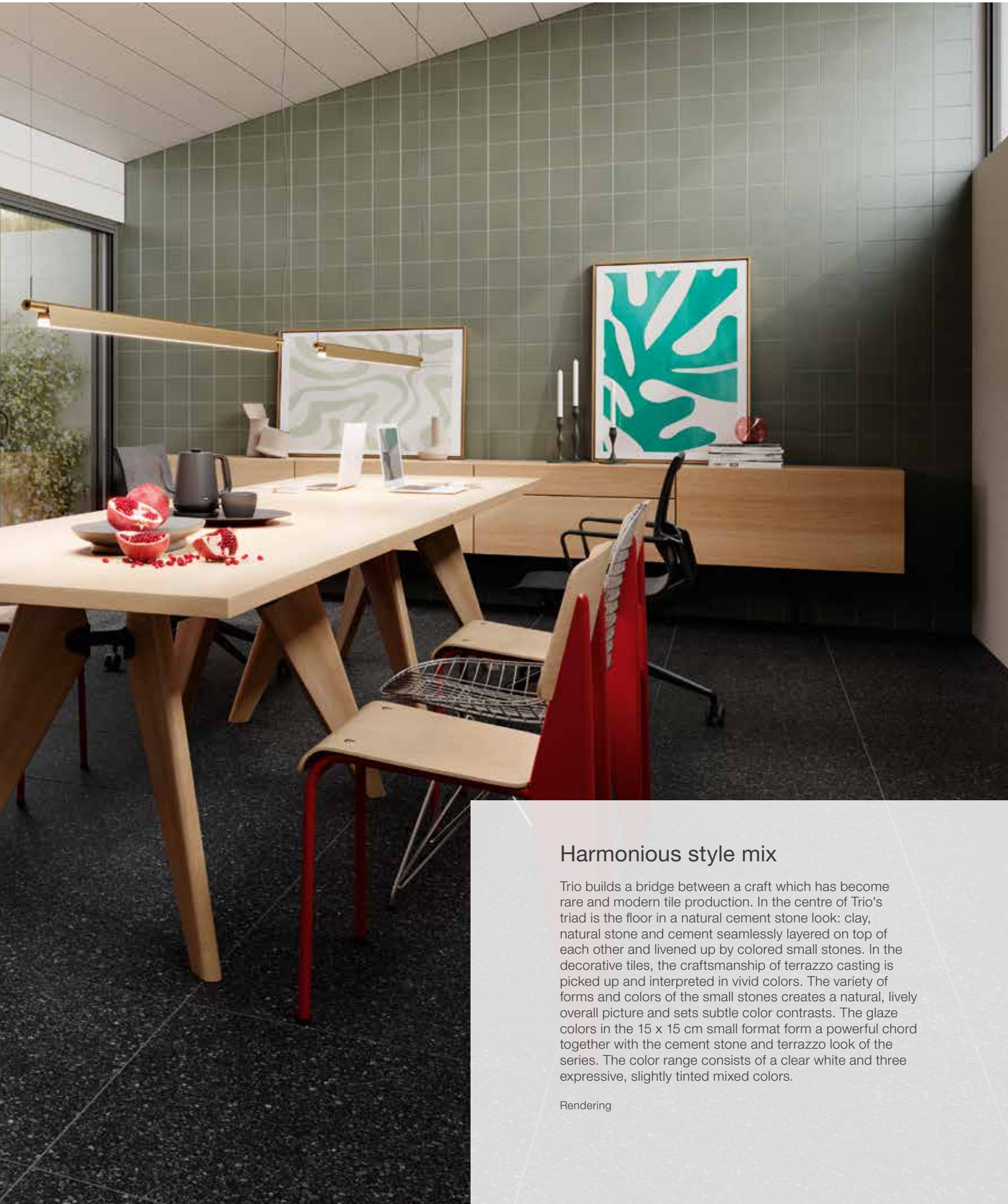

Harmonious style mix

Trio builds a bridge between a craft which has become rare and modern tile production. In the centre of Trio's triad is the floor in a natural cement stone look: clay, natural stone and cement seamlessly layered on top of each other and livened up by colored small stones. In the decorative tiles, the craftsmanship of terrazzo casting is picked up and interpreted in vivid colors. The variety of forms and colors of the small stones creates a natural, lively overall picture and sets subtle color contrasts. The glaze colors in the 15 x 15 cm small format form a powerful chord together with the cement stone and terrazzo look of the series. The color range consists of a clear white and three expressive, slightly tinted mixed colors.

Rendering

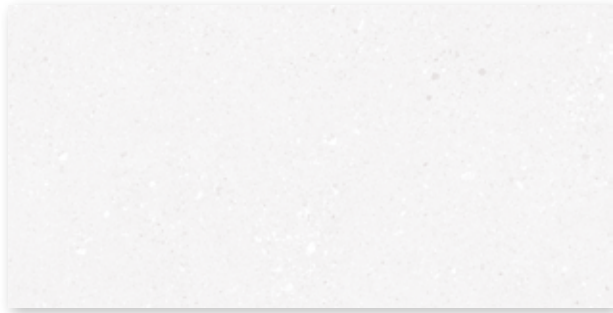

Wall tile 30 x 60 cm, 12 x 24 in, silk white, structured

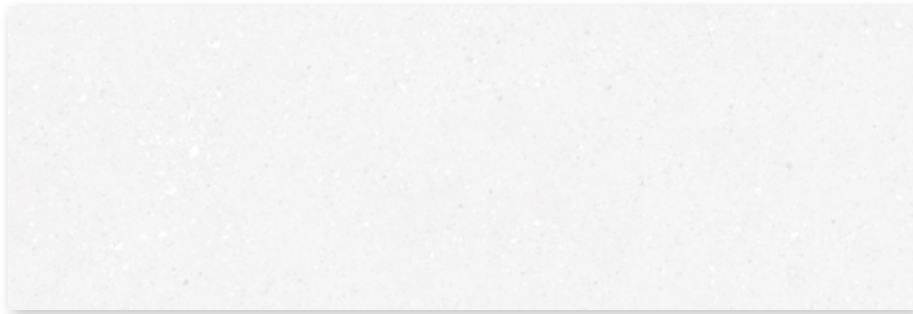

Wall tile 30 x 90 cm, 12 x 36 in, silk white, structured

Decoration elements



Decorative tile Terrazzo 30 x 60 cm, 12 x 24 in, beige mix, structured



Decorative tile Terrazzo 30 x 90 cm, beige mix, structured

Decoration elements



Decorative tile Color
15 x 15 cm, 6 x 6 in, brick,
smooth



Decorative tile Color
15 x 15 cm, 6 x 6 in, olive,
smooth



Decorative tile Color
15 x 15 cm, 6 x 6 in, aqua,
smooth

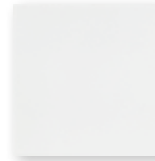

Decorative tile Color
15 x 15 cm, 6 x 6 in, platin,
smooth



Decorative tile Lines
15 x 15 cm, 6 x 6 in, brick,
relief



Decorative tile Lines
15 x 15 cm, 6 x 6 in, olive,
relief



Decorative tile Lines
15 x 15 cm, 6 x 6 in, aqua,
relief

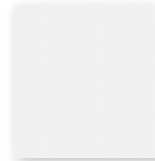

Decorative tile Lines
15 x 15 cm, 6 x 6 in, platin,
relief

Mosaic 5 x 5 cm, 2 x 2 in



Mosaic sheet 30 x 30 cm, 12 x 12 in,
ivory white, structured, R10/A+B

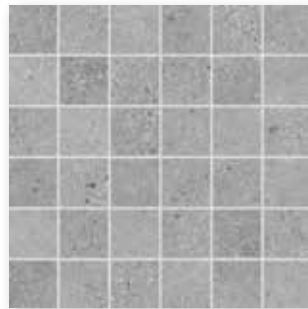

Mosaic sheet 30 x 30 cm, 12 x 12 in,
cement grey, structured, R10/A+B

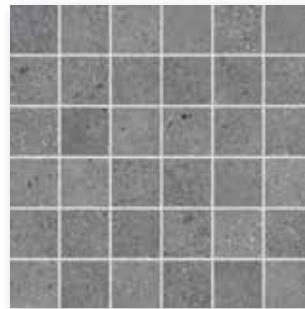

Mosaic sheet 30 x 30 cm, 12 x 12 in,
iron grey, structured, R10/A+B



Mosaic sheet 30 x 30 cm, 12 x 12 in,
mud grey, structured, R10/A+B



Mosaic sheet 30 x 30 cm, 12 x 12 in,
slate black, structured, R10/A+B

Mosaic: glass fibre net on reverse side,
sheet: 297 x 297 mm



ivory white



cement grey



iron grey



mud grey

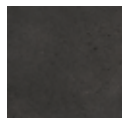

slate black



Floor tile 30 x 60 cm, 12 x 24 in, structured, R10/A+B



Floor tile 60 x 60 cm, 24 x 24 in, structured, R10/A+B



Floor tile 60 x 120 cm, 24 x 48 in, structured, R10/A+B



R10/A+B R11/B



Stair tile 30 x 60 cm, 12 x 24 in (with grooves), structured, R10/A+B



Stair tile 30 x 120 cm, 12 x 48 in (with grooves), structured, R10/A+B



Skirting, rounded 7 x 60 cm, 2 13/16 x 24 in, structured



Patio tile 60 x 60 cm, 24 x 24 in, ivory white, structured, R11/B

without illustration:

Patio tile 120 x 120 cm, 48 x 48 in, cement grey, structured, R11/B

Patio tile 120 x 120 cm, 48 x 48 in, slate black, structured, R11/B

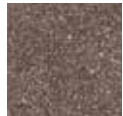

terrazzo red



terrazzo black



terrazzo ivory



Floor tile Terrazzo 60 x 60 cm, 24 x 24 in, structured, R10/A+B



Floor tile Terrazzo 60 x 120 cm, 24 x 48 in, structured, R10/A+B



Stair tile Terrazzo 30 x 120 cm, 12 x 48 in, (with grooves), structured, R10/A+B

Wall Tiles

Decoration Elements⁴

30 x 60 m¹



30 x 90 cm³



30 x 60 cm

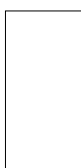

30 x 90 cm³



15 x 15 cm²



15 x 15 cm²



	Decorative tile Terrazzo	Decorative tile Terrazzo	Decorative tile Color	Decorative tile Lines			
	30 x 60 / 12 x 24	30 x 90 / 12 x 36	30 x 60 / 12 x 24	30 x 90 / 12 x 36	15 x 15 / 6 x 6	15 x 15 / 6 x 6	Nom. dim. - cm/in
	297 x 597 x 6 mm	297 x 897 x 6 mm	297 x 597 x 6 mm	297 x 897 x 6 mm	147 x 147 x 6.5 mm	147 x 147 x 6.5 mm	Work size
	structured, stone-matt	structured, stone-matt	structured, stone-matt	structured, stone-matt	smooth, matt	relief, glossy	Surface
	5.556	3.704	5.556	3.704	44.444	44.444	m ² - pieces
	10.279	10.400	10.279	10.400	13.955	13.955	m ² - kg
	13	8	13	8	44	44	Bundle - pieces
	2.340	2.160	2.340	2.160	0.990	0.990	Bundle - m ²
	24.050	22.464	24.050	22.464	13.816	13.816	Bundle - kg
	112.311	51.836	112.311	51.836	79.201	79.201	Pallet - m ²
	1,154.400	539.136	1,154.400	539.136	1,105.280	1,105.280	Pallet - kg
	BIII	BIII	BIII	BIII	Bla (GL)	Bla (GL)	Product standard
							Slip resistance
					1		Stress group
	203416H	323418H					silk white <input type="checkbox"/> V1
	Price gr. C107 (m ²)	Price gr. C149 (m ²)					beige mix <input type="checkbox"/> V4
			203417H	323419H	133420H		1 brick <input type="checkbox"/> V1
			Price gr. C116 (m ²)	Price gr. C155 (m ²)	Price gr. C152 (m ²)	133424H	2 brick <input type="checkbox"/> V2
						Price gr. C152 (m ²)	olive <input type="checkbox"/> V1
					133421H		olive <input type="checkbox"/> V2
					Price gr. C152 (m ²)	133425H	aqua <input type="checkbox"/> V1
						Price gr. C152 (m ²)	aqua <input type="checkbox"/> V2
					133422H		platinum <input type="checkbox"/> V1
					Price gr. C152 (m ²)	133426H	platinum <input type="checkbox"/> V2
						Price gr. C152 (m ²)	
					133423H		
					Price gr. C152 (m ²)	133427H	
						Price gr. C152 (m ²)	



⁴ Decoration elements only available in full boxes.

Mosaic¹

Floor Tiles¹

Stair Tiles^{1/2}

5 x 5 cm⁵



30 x 60 cm

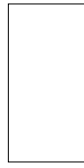

60 x 60 cm

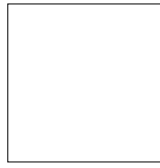

60 x 60 cm⁶

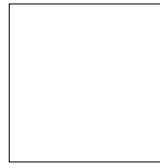

60 x 120 cm^{3/4}

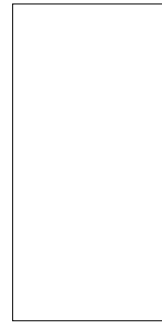

30 x 60 cm



30 x 120 cm

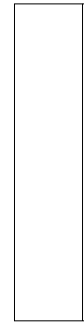

Sheet: 297 x 297 mm

extra thick

Nom. dim. - cm/in	5 x 5 / 2 x 2	30 x 60 / 12 x 24	60 x 60 / 24 x 24	60 x 60 / 24 x 24	60 x 120 / 24 x 48	30 x 60 / 12 x 24	30 x 120 / 12 x 48
Work size	47 x 47 x 9 mm	297 x 597 x 9 mm	597 x 597 x 9 mm	600 x 600 x 14 mm	597 x 1197 x 9 mm	297 x 597 x 9 mm	297 x 1197 x 9 mm
Surface	structured, matt	structured, matt	structured, matt	structured, matt	structured, matt	structured, matt	structured, matt
m ² /m - pieces	11.111 sheets/m ²	5.556/m ²	2.778/m ²	2.778/m ²	1.388/m ²	1.667/m	0.833/m
m ² /m - kg	19.833/m ²	19.907/m ²	20.371/m ²	31.669/m ²	21.132/m ²	5.973/m	6.341/m
Bundle - pieces	12 sheets	7	3	2	2	7	3
Bundle - m ² /m	1.080 m ²	1.260 m ²	1.080 m ²	0.720 m ²	1.441 m ²	4.199 m	3.601 m
Bundle - kg	21.420	25.081	21.999	22.800	30.450	25.081	22.836
Pallet - m ²	32.400	50.396	45.356	30.238	50.432		
Pallet - kg	642.600	1,003.240	923.958	957.600	1.065.750		
Product standard	Bla	Bla	Bla	Bla	Bla	Bla	Bla
Slip resistance	R10/A+B	R10/A+B	R10/A+B	R10	R10/A+B	R10/A+B	R10/A+B
Stress group	2	2	2	4	2	2	2
ivory white	431647H Price gr. C293 (m ²)	431652H Price gr. C125 (m ²)	431657H Price gr. C140 (m ²)		431665H Price gr. C152 (m ²)	431677H Price gr. C474 (pce.)	431682H Price gr. C517 (pce.)
cement grey	431648H Price gr. C293 (m ²)	431653H Price gr. C125 (m ²)	431658H Price gr. C140 (m ²)		431666H Price gr. C152 (m ²)	431678H Price gr. C474 (pce.)	431683H Price gr. C517 (pce.)
iron grey	431649H Price gr. C293 (m ²)	431654H Price gr. C125 (m ²)	431659H Price gr. C140 (m ²)		431667H Price gr. C152 (m ²)	431679H Price gr. C474 (pce.)	431684H Price gr. C517 (pce.)
mud grey	431650H Price gr. C293 (m ²)	431655H Price gr. C125 (m ²)	431660H Price gr. C140 (m ²)		431668H Price gr. C152 (m ²)	431680H Price gr. C474 (pce.)	431685H Price gr. C517 (pce.)
slate black	431651H Price gr. C293 (m ²)	431656H Price gr. C125 (m ²)	431661H Price gr. C140 (m ²)		431669H Price gr. C152 (m ²)	431681H Price gr. C474 (pce.)	431686H Price gr. C517 (pce.)
terrazzo red			431662H Price gr. C140 (m ²)	431692H	431695H Price gr. C152 (m ²)		431965H Price gr. C517 (pce.)
terrazzo black			431663H Price gr. C140 (m ²)	431693H	431696H Price gr. C152 (m ²)		431966H Price gr. C517 (pce.)
terrazzo ivory			431664H Price gr. C140 (m ²)	431694H	431697H Price gr. C152 (m ²)		431967H Price gr. C517 (pce.)



³ High weight only to carry with two persons.
⁴ Important: special pallet, no return, no exchange.
⁵ Glass fibre net on reverse side
⁶ Prices are calculated project-specifically..

Skirting,
rounded¹

7 x 60 cm



Patio Tiles^{1/2}

60 x 60 cm



120 x 120 cm^{3/4}

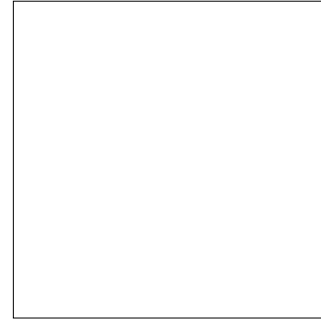

			7 x 60 / 2 13/16 x 24	60 x 60 / 24 x 24	120 x 120 / 48 x 48		Nom. dim. - cm/in
			70 x 597 x 9 mm	597 x 597 x 20 mm	1198 x 1198 x 20 mm		Work size
			structured, matt	structured, matt	structured, matt		Surface
			1.667/m	2.778/m ²	0.694/m ²		m ² /m - pieces
			1.357/m	45.273/m ²	46.567/m ²		m ² /m - kg
			15	2	1		Bundle - pieces
			8.998 m	0.720 m ²	1.440 m ²		Bundle - m ² /m
			12.210	32.594	67.100		Bundle - kg
				21.598	28.560		Pallet - m ²
				977.820	1,342.000		Pallet - kg
			Bla	Bla	Bla		Product standard
				R11/B	R11/B		Slip resistance
				4	4		Stress group
			431687H	431670H			ivory white <input type="checkbox"/> V3
			Price gr. C440 (pce.)	Price gr. C200 (m ²)			
			431688H	431671H	431675		cement grey <input type="checkbox"/> V3
			Price gr. C440 (pce.)	Price gr. C200 (m ²)	Price gr. C260 (m ²)		
			431689H	431672H			iron grey <input type="checkbox"/> V3
			Price gr. C440 (pce.)	Price gr. C200 (m ²)			
			431690H	431673H			mud grey <input type="checkbox"/> V3
			Price gr. C440 (pce.)	Price gr. C200 (m ²)			
			431691H	431674H	431676		slate black <input type="checkbox"/> V3
			Price gr. C440 (pce.)	Price gr. C200 (m ²)	Price gr. C260 (m ²)		



¹

² High weight only to carry with two persons.

³ without Hytect coating; with Protecta upgrading

⁴ Important: special pallet, no return, no exchange.







Expressive and versatile

With eight formats, four colors and two slip-resistance categories, the Unique series is suitable for many areas of application. The color spectrum of the Protecta-upgraded porcelain stoneware floor tiles, which ranges from beige to anthracite, the slightly structured, discreet surface as well as the slip-resistance categories R10/A and R10/B enable versatile use, also in wet areas.

Head office of pbr Planungsbüro Rohling AG, Osnabrück, Germany
Architect: pbr Planungsbüro Rohling AG, Osnabrück
Photo: Martin Lukas Kim Fotografie, Hamburg



R10/A R10/B



Made in Germany



anthracite



basalt



light-grey



beige



Oblong format 5 x 60 cm, 2 x 24 in, smooth, R10/A

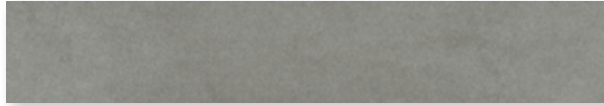

Oblong format 10 x 60 cm, 4 x 24 in, smooth, R10/A

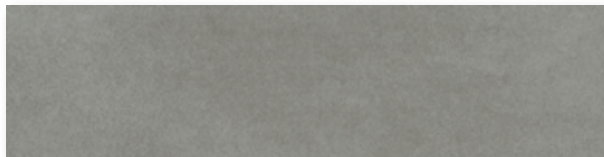

Oblong format 15 x 60 cm, 6 x 24 in, smooth, R10/A



Floor tile 30 x 30 cm, 12 x 12 in, smooth, R10/A



Floor tile 30 x 60 cm, 12 x 24 in, smooth, R10/A

Mosaic 5 x 5 cm, 2 x 2 in

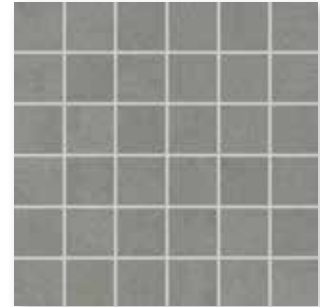

Mosaic sheet 30 x 30, 12 x 12 in, structured, R10/B



R10/A

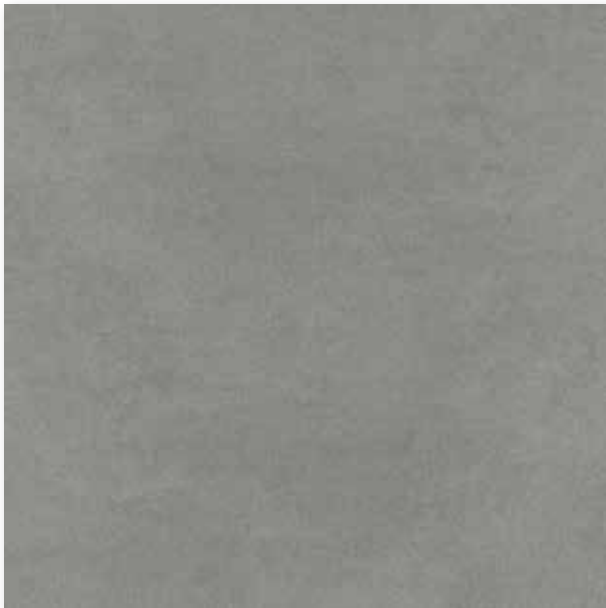

Floor tile 60 x 60 cm, 24 x 24 in, smooth, R10/A



Stair tile 30 x 60 cm, 12 x 24 in (with grooves), smooth, R10/A



Skirting, rounded 7 x 60 cm, 2 13/16 x 24 in, smooth



Floor tile 60 x 120 cm, 24 x 48 in, smooth, R10/A

Mosaic^{1/3}

Floor Tiles¹

5 x 5 cm



5 x 60 cm²



10 x 60 cm²



15 x 60 cm²



30 x 30 cm



30 x 60 cm



protected

Sheet: 297x297 mm

Oblong format

Oblong format

Oblong format

Nom. dim. - cm/in	5 x 5 / 2 x 2	5 x 60 / 2 x 24	10 x 60 / 4 x 24	15 x 60 / 6 x 24	30 x 30 / 12 x 12	30 x 60 / 12 x 24	
Work size	47 x 47 x 10.5 mm	47 x 597 x 10.5 mm	97 x 597 x 10.5 mm	147 x 597 x 10.5 mm	297 x 297 x 10.5 mm	297 x 597 x 10.5 mm	
Surface	structured, matt	smooth, matt	smooth, matt	smooth, matt	smooth, matt	smooth, matt	
m ² - pieces	11.111	33.333	16.667	11.111	11.111	5.556	
m ² - kg	21.966	21.966	21.967	21.966	21.966	21.974	
Bundle - pieces	11 sheets	33	15	11	11	6	
Bundle - m ²	0.990	0.990	0.900	0.990	0.990	1.080	
Bundle - kg	21.747	21.747	19.770	21.747	21.747	23.730	
Pallet - m ²	29.700	39.600	35.999	39.600	41.580	43.197	
Pallet - kg	652.410	869.880	790.800	869.880	913.374	949.200	
Product standard	Alb	Alb	Alb	Alb	Alb	Alb	
Slip resistance	R10/B	R10/A	R10/A	R10/A	R10/A	R10/A	
Stress group	2	2	2	2	2	2	
anthracite	433793 Price gr. A265 (m ²)	<i>433787</i> <i>Price gr. A211 (m²)</i>	<i>433770</i> <i>Price gr. A211 (m²)</i>	<i>433778</i> <i>Price gr. A199 (m²)</i>	433841 Price gr. A115 (m ²)	433671 Price gr. A127 (m ²)	
basalt	433794 Price gr. A265 (m ²)	<i>433786</i> <i>Price gr. A211 (m²)</i>	<i>433771</i> <i>Price gr. A211 (m²)</i>	<i>433779</i> <i>Price gr. A199 (m²)</i>	433842 Price gr. A115 (m ²)	433672 Price gr. A127 (m ²)	
light-grey	433795 Price gr. A265 (m ²)	<i>433789</i> <i>Price gr. A211 (m²)</i>	<i>433772</i> <i>Price gr. A211 (m²)</i>	<i>433780</i> <i>Price gr. A199 (m²)</i>	433843 Price gr. A115 (m ²)	433673 Price gr. A127 (m ²)	
beige	433796 Price gr. A265 (m ²)	<i>433891</i> <i>Price gr. A211 (m²)</i>	<i>433773</i> <i>Price gr. A211 (m²)</i>	<i>433781</i> <i>Price gr. A199 (m²)</i>	433844 Price gr. A115 (m ²)	433674 Price gr. A127 (m ²)	

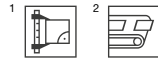

³ Glass fibre net on reverse side

Floor Tiles¹

Stair Tiles^{1/2}

Skirting, rounded¹

60 x 60 cm

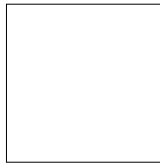

60 x 120 cm³



30 x 60 cm



7 x 60 cm



protected

			60 x 60 / 24 x 24	60 x 120 / 24 x 48	30 x 60 / 12 x 24	7 x 60 / 2 13/16 x 24	Nom. dim. - cm/in
			597 x 597 x 10.5 mm	597 x 1197 x 8 mm	297 x 597 x 10.5 mm	70 x 597 x 10.5 mm	Work size
			smooth, matt	smooth, matt	smooth, matt	smooth, matt	Surface
			2.778/m ²	1.388/m ²	1.667/m	1.667/m	m ² /m - pieces
			21.996/m ²	17.489/m ²	6.593/m	1.554/m	m ² /m - kg
			3	2	6	15	Bundle - pieces
			1.080 m ²	1.441 m ²	3.599 m	8.998 m	Bundle - m ² /m
			23.754	25.200	23.730	13.980	Bundle - kg
			32.397	36.023			Pallet - m ²
			712.620	630.000			Pallet - kg
			Alb	Alb	Alb	Alb	Product standard
			R10/A	R10/A	R10/A		Slip resistance
			2	2	2		Stress group
			433701	434432	433678	433685	
			Price gr. A142 (m ²)	Price gr. A169 (m ²)	Price gr. A465 (pce.)	Price gr. A441 (pce.)	anthracite <input type="checkbox"/> V2
			433702	434433	433679	433686	
			Price gr. A142 (m ²)	Price gr. A169 (m ²)	Price gr. A465 (pce.)	Price gr. A441 (pce.)	basalt <input type="checkbox"/> V2
			433703	434434	433680	433687	
			Price gr. A142 (m ²)	Price gr. A169 (m ²)	Price gr. A465 (pce.)	Price gr. A441 (pce.)	light-grey <input type="checkbox"/> V2
			433704	434435	433681	433688	
			Price gr. A142 (m ²)	Price gr. A169 (m ²)	Price gr. A465 (pce.)	Price gr. A441 (pce.)	beige <input type="checkbox"/> V2



³ High weight only to carry with two persons.







Natural and lively

The Valley porcelain stoneware series was inspired by the panorama of the distant landscape of a valley plain. Its earthy relief and its fine, grainy textures bear witness to this. Each color evokes different associations: of blue or clay slate, river pebbles, sand and earth. The effects of the weather, earth movements, water flows and metallic material deposits also create a lively surface with a typical "mountain-valley" effect. The series is rounded off by an extra thick, frost-resistant patio tile in all four colors, which is also suitable for laying in sand or gravel.

Wellness Hostel 4000, Saas Fee, Switzerland
Architect: Steinmann & Schmid Arch. AG BSA SIA
Photo: Adriano Faragulo



R10/A R10/B R11/B



schiefer



pebble-grey



earth-brown



sand-beige



Oblong format 5 x 60 cm, 2 x 24 in, structured, R10/A



Oblong format 10 x 60 cm, 4 x 24 in, structured, R10/A



Oblong format 15 x 60 cm, 6 x 24 in, structured, R10/A

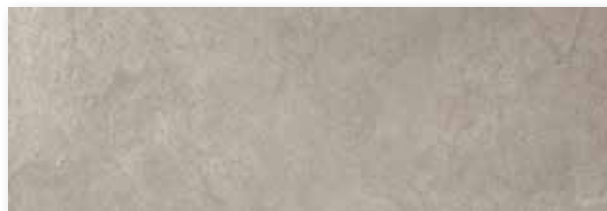

Oblong format 20 x 60 cm, 8 x 24 in, structured, R10/A

Mosaic 5 x 5 cm, 2 x 2 in



Mosaic sheet 30 x 30 cm, 12 x 12 in smooth, R11/B



Floor/wall tile 15 x 15 cm, 6 x 6 in structured, R10/B



Floor/wall tile 30 x 30 cm structured, R11/B



Floor/wall tile 30 x 60 cm, 12 x 24 in, structured, R10/A
Floor/wall tile 30 x 60 cm, 12 x 24 in, structured, R11/B



Floor tile 60 x 60 cm, 24 x 24 in, structured, R10/A
Patio tile 60 x 60 cm, 24 x 24 in, structured, R11/B

Ceramic cover channel,
25 x 50 cm, 10 x 20 in



Ceramic cover channel,
corner solution 30 x 30 cm,
12 x 12 in



For details about the Ceramic channel cover,
refer to the Pool + Spa programme of delivery.



Floor tile 60 x 120 cm, 24 x 48 in, structured, R10/A



Skirting, rounded 7 x 60 cm, 2 13/16 x 24 in, structured



Stair tile 30 x 60 cm, 12 x 24 in (with grooves), structured, R10/A

Mosaic^{1/3} Floor/Wall Tiles¹



protected

Sheet: 297 x 297 mm

Oblong format

Oblong format

Oblong format

Oblong format

Nom. dim. - cm/in	5 x 5 / 2 x 2	15 x 15 / 6 x 6	5 x 60 / 2 x 24	10 x 60 / 4 x 24	15 x 60 / 6 x 24	20 x 60 / 8 x 24
Work size	47 x 47 x 10 mm	147 x 147 x 8 mm	46 x 596 x 10 mm	96 x 596 x 10 mm	146 x 596 x 10 mm	196 x 596 x 10 mm
Surface	structured, matt	structured, matt	structured, matt	structured, matt	structured, matt	structured, matt
m ² - pieces	11.111	44.444	33.333	16.667	11.111	8.333
m ² - kg	21.800	17.555	22.233	22.667	22.000	23.749
Bundle - pieces	11 sheets	35	33	15	11	8
Bundle - m ²	0.990	0.788	0.990	0.900	0.990	0.960
Bundle - kg	21.582	13.825	22.011	20.400	21.780	22.800
Pallet - m ²	29.700	63.001	39.600	35.999	39.600	40.322
Pallet - kg	647.460	1,106.000	880.440	816.000	871.200	957.600
Product standard	Bla	Bla	Bla	Bla	Bla	Bla
Slip resistance	R11/B	R10/B	R10/A	R10/A	R10/A	R10/A
Stress group	2	2	2	2	2	2
slate	052089 Price gr. A292 (m ²)	052477 Price gr. A142 (m ²)	052044 Price gr. A217 (m ²)	052048 Price gr. A217 (m ²)	052052 Price gr. A211 (m ²)	052461 Price gr. A211 (m ²)
pebble-grey	052090 Price gr. A292 (m ²)	052478 Price gr. A142 (m ²)	052045 Price gr. A217 (m ²)	052049 Price gr. A217 (m ²)	052053 Price gr. A211 (m ²)	052462 Price gr. A211 (m ²)
earth-brown	052091 Price gr. A292 (m ²)	052479 Price gr. A142 (m ²)	052046 Price gr. A217 (m ²)	052050 Price gr. A217 (m ²)	052054 Price gr. A211 (m ²)	052463 Price gr. A211 (m ²)
sand-beige	052092 Price gr. A292 (m ²)	052480 Price gr. A142 (m ²)	052047 Price gr. A217 (m ²)	052051 Price gr. A217 (m ²)	052055 Price gr. A211 (m ²)	052464 Price gr. A211 (m ²)



Floor/Wall Tiles¹

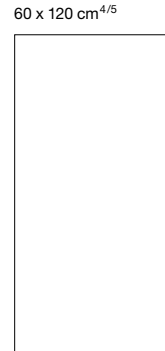
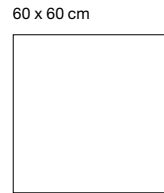
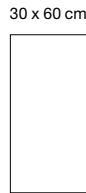
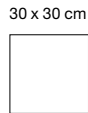

protected

Nom. dim. - cm/in	30 x 30 / 12 x 12	30 x 60 / 12 x 24	30 x 60 / 12 x 24	60 x 60 / 24 x 24	60 x 120 / 24 x 48
Work size	297 x 297 x 10 mm	297 x 596 x 10 mm	297 x 596 x 10 mm	596 x 596 x 10 mm	596 x 1195 x 10.5 mm
Surface	structured, matt	structured, matt	structured, matt	structured, matt	structured, matt
m ² - pieces	11.111	5.556	5.556	2.778	1.388
m ² - kg	23.144	22.780	22.780	22.780	23.180
Bundle - pieces	11	6	6	3	2
Bundle - m ²	0.990	1.080	1.080	1.080	1.441
Bundle - kg	22.913	24.600	24.600	24.600	33.400
Pallet - m ²	41.580	43.197	43.197	43.197	50.432
Pallet - kg	962.346	984.000	984.000	984.000	1,169.000
Product standard	Bla	Bla	Bla	Bla	Bla
Slip resistance	R11/B	R10/A	R11/B	R10/A	R10/A
Stress group	3	2	2	3	2
slate	052032 Price gr. A121 (m ²)	052016 Price gr. A109 (m ²)	052036 Price gr. A121 (m ²)	052020 Price gr. A121 (m ²)	052024 Price gr. A154 (m ²)
pebble-grey	052033 Price gr. A121 (m ²)	052017 Price gr. A109 (m ²)	052037 Price gr. A121 (m ²)	052021 Price gr. A121 (m ²)	052025 Price gr. A154 (m ²)
earth-brown	052034 Price gr. A121 (m ²)	052018 Price gr. A109 (m ²)	052038 Price gr. A121 (m ²)	052022 Price gr. A121 (m ²)	052026 Price gr. A154 (m ²)
sand-beige	052035 Price gr. A121 (m ²)	052019 Price gr. A109 (m ²)	052039 Price gr. A121 (m ²)	052023 Price gr. A121 (m ²)	052027 Price gr. A154 (m ²)

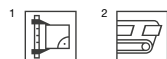

³ Glass fibre net on reverse side
⁴ High weight only to carry with two persons.

⁵ Please note: special pallet. No return, no exchange.

Stair Tiles^{1/2}

30 x 60 cm



Skirting, rounded¹

7 x 60 cm



Patio Tile^{1/3}

60 x 60 cm

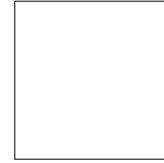

protected

				30 x 60 / 12 x 24	7 x 60 / 2 13/16 x 24	60 x 60 / 24 x 24	
				297 x 596 x 10 mm	70 x 596 x 10 mm	596 x 596 x 20 mm	Nom. dim. - cm/in
				structured, matt	structured, matt	structured, matt	Work size
				1.667/m	1.667/m	2.778/m ²	Surface
				6.968/m	1.550/m	46.948/m ²	m²/m - pieces
				6	22	2	m²/m - kg
				3.599 m	13.197 m	0.720 m ²	Bundle - pieces
				25.080	20.460	33.800	Bundle - m ² /m
						21.598	Bundle - kg
						1,014.000	Pallet - m ²
				Bla	Bla	Bla	Pallet - kg
				R10/A		R11/B	Product standard
				2		4	Slip resistance
				052068	052072	052085	Stress group
				Price gr. A475 (pce.)	Price gr. A438 (pce.)	Price gr. A178 (m ²)	slate <input type="checkbox"/> V2
				052069	052073	052086	pebble-grey <input type="checkbox"/> V2
				Price gr. A475 (pce.)	Price gr. A438 (pce.)	Price gr. A178 (m ²)	earth-brown <input type="checkbox"/> V2
				052070	052074	052087	sand-beige <input type="checkbox"/> V2
				Price gr. A475 (pce.)	Price gr. A438 (pce.)	Price gr. A178 (m ²)	
				052071	052075	052088	
				Price gr. A475 (pce.)	Price gr. A438 (pce.)	Price gr. A178 (m ²)	

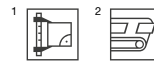

³ High weight only to carry with two persons.





Powerful, relaxed and timeless

Walden is a classic, natural wood design manufactured in high-quality ceramics. It is a natural product which combines the popularity of authentic wood surfaces with the advantages of ceramic covering materials. The 5 color shades in the classic 20 x 120 cm plank format serve a wide range of different styles and can be combined harmoniously or in contrast with other materials as desired. The slip resistance R10/A+B provides for versatile application possibilities in private and public interiors.

Rendering



R10/A+B



sunny white



relax beige



classic oak



brown cherry



smokey brown



Floor tile 20 x 120 cm, 8 x 48 in, structured, R10/A+B



Skirting, rounded 6 x 60 cm, 2 3/8 x 24 in, structured

Floor Tile^{1/2}

Skirting rounded¹

20 x 120 cm



6 x 60 cm



protected

					20 x 120 / 8 x 48	6 x 60 / 2 3/8 x 24	Nom. dim. - cm/in
					197 x 1195 x 9 mm	60 x 596 x 9 mm	Work size
					structured, matt	structured, matt	Surface
					4.166/m ²	1.667/m	m ² /m - pieces
					20.830/m ²	1.237/m	m ² /m - kg
					6	27	Bundle - pieces
					1.440 m ²	16.197 m	Bundle - m ² /m
					30.000	20.034	Bundle - kg
					60.490		Pallet - m ²
					1,260.000		Pallet - kg
					Bla	Bla	Product standard
					R10/A+B		Slip resistance
					2		Stress group
					430685	430690	
					Price gr. C143 (m ²)	Price gr. C437 (pce.)	sunny white <input type="checkbox"/> V2
					430686	430691	
					Price gr. C143 (m ²)	Price gr. C437 (pce.)	relax beige <input type="checkbox"/> V2
					430687	430692	
					Price gr. C143 (m ²)	Price gr. C437 (pce.)	classic oak <input type="checkbox"/> V2
					430688	430693	
					Price gr. C143 (m ²)	Price gr. C437 (pce.)	brown cherry <input type="checkbox"/> V2
					430689	430694	
					Price gr. C143 (m ²)	Price gr. C437 (pce.)	smokey brown <input type="checkbox"/> V2



² Please note: special pallet. No return, no exchange.





Contents

• Article numbers	500 - 510
• Index according to models	511 - 512
• Model numbers	513
• Classification accord. to NCS/RAL / Lightness values	514 - 515
• Luminance contrast	516 - 519
Technical information	520 - 539
World-wide distribution network	542 - 543
Comments	546 - 547



As of now, you will find all article numbers for our pool edge systems and swimming pool special pieces in our Pool + Spa programme of delivery.

Article No.	Page(s)	Article No.	Page(s)	Article No.	Page(s)	Article No.	Page(s)	Article No.	Page(s)	Article No.	Page(s)
0002	301	052480	492	130-1050H	346	182763	107	203416H	479	239996	107
010D-1010	291	101630-6635	127	130-1111H	344	182764	107	203417H	479	239997	107
010D-1630	291	101630-6636	127	130-1112H	344	183343	107	203431H	454	239998	107
052016	492	103197-6635	127	130-1113H	344	183344	107	203432H	454	240-1001H	344
052017	492	103197-6636	127	130-1115H	344	19020-2290H	181	203433H	454	240-1002H	344
052018	492	111052	107	130-1117H	344	19020-2320H	181	203434H	454	240-1003H	344
052019	492	112000	107	130-1118H	344	19020-9215H	181	203435H	44	240-1004H	344
052020	492	113063	107	130-1119H	344	19021-2290H	181	203436H	44	240-1005H	344
052021	492	115100	107	130-1120H	344	19021-2320H	181	203439	44	240-1006H	344
052022	492	130-1001H	344	130-1121H	344	19021-9215H	181	203440	44	240-1007H	344
052023	492	130-1002H	344	133420H	479	19022-2290H	181	203441	44	240-1008H	344
052024	492	130-1003H	344	133421H	479	19022-2320H	181	203442	44	240-1009H	344
052025	492	130-1004H	344	133422H	479	19022-9215H	181	203443	44	240-1010H	344
052026	492	130-1005H	344	133423H	479	19024-2290H	181	203444	108	240-1011H	344
052027	492	130-1006H	344	133424H	479	19024-2320H	181	203445	108	240-1012H	344
052032	492	130-1007H	344	133425H	479	19024-9215H	181	203459R	108	240-1013H	344
052033	492	130-1008H	344	133426H	479	19025-2290H	181	203460R	108	240-1014H	344
052034	492	130-1009H	344	133427H	479	19025-2320H	181	203461HR	109	240-1015H	344
052035	492	130-1010H	344	144-12020	149	19025-9215H	181	203462HR	109	240-1016H	344
052036	492	130-1011H	344	144-12050	149	19026-2290H	181	203479H	214	240-1017H	345
052037	492	130-1012H	344	144-18120	149	19026-2320H	181	203480H	214	240-1018H	345
052038	492	130-1013H	344	144-18210	149	19026-9215H	181	203481H	214	240-1019H	345
052039	492	130-1014H	344	144-41550K	149	19027-2290H	181	203482H	214	240-1020H	345
052044	492	130-1015H	344	144-42550K	149	19027-2320H	181	203505H	420	240-1021H	345
052045	492	130-1016H	344	150i-12020H	149	19027-9215H	181	203506H	420	240-1022H	345
052046	492	130-1017H	345	150i-12050H	149	19030-2290H	181	203507H	420	240-1023H	345
052047	492	130-1018H	345	150i-18120H	149	19030-2320H	181	203508H	420	240-1024H	345
052048	492	130-1019H	345	150i-18210H	149	19030-9215H	181	203509H	420	240-1025H	345
052049	492	130-1020H	345	150i-41550HK	149	19031-2290H	181	203510H	420	240-1026H	345
052050	492	130-1021H	345	150i-42550HK	149	19031-2320H	181	203511	437	240-1027H	345
052051	492	130-1022H	345	151i-12020H	149	19031-9215H	181	203512	437	240-1028H	345
052052	492	130-1023H	345	151i-12050H	149	19032-2290H	181	203513	437	240-1029H	345
052053	492	130-1024H	345	151i-18120H	149	19032-2320H	181	203514	437	240-1030H	345
052054	492	130-1025H	345	151i-18210H	149	19032-9215H	181	203515	437	240-1031H	345
052055	492	130-1026H	345	151i-41550HK	149	19033-2290H	181	203516	437	240-1032H	345
052068	493	130-1027H	345	151i-42550HK	149	19033-2320H	181	203517	437	240-1033H	345
052069	493	130-1028H	345	152i-12020H	149	19033-9215H	181	203518	437	240-1034H	345
052070	493	130-1029H	345	152i-12050H	149	203225H	84	203519	437	240-1035H	345
052071	493	130-1030H	345	152i-18120H	149	203226H	84	203520	437	240-1036H	345
052072	493	130-1031H	345	152i-18210H	149	203229H	84	203521	437	240-1037H	345
052073	493	130-1032H	345	152i-41550HK	149	203232H	66	203522	437	240-1038H	345
052074	493	130-1033H	345	152i-42550HK	149	203233H	66	203523	437	240-1039H	345
052075	493	130-1034H	345	153i-12020H	149	203234H	66	203524	437	240-1040H	345
052085	493	130-1035H	345	153i-12050H	149	203264	108	203525	437	240-1111H	344
052086	493	130-1036H	345	153i-18120H	149	203265	108	203526	437	240-1112H	344
052087	493	130-1037H	345	153i-18210H	149	203266H	109	203527	437	240-1113H	344
052088	493	130-1038H	345	153i-41550HK	149	203267H	109	203528	437	240-1115H	344
052089	492	130-1039H	345	153i-42550HK	149	203331H	391	213341	107	240-1117H	344
052090	492	130-1040H	345	154i-12020H	149	203333H	84	213342	107	240-1118H	344
052091	492	130-1041H	346	154i-12050H	149	203392H	271	2203-B600HK	245	240-1119H	344
052092	492	130-1042H	346	154i-18120H	149	203393H	271	2204-B600HK	245	240-1120H	344
052461	492	130-1043H	346	154i-18210H	149	203394H	271	2205-B600HK	245	240-1121H	344
052462	492	130-1044H	346	154i-41550HK	149	203408	398	2206-B600HK	245	2401RH-K100-21	189
052463	492	130-1045H	346	154i-42550HK	149	203409	398	2207-B600HK	245	2452	233
052464	492	130-1046H	346	173339	107	203410	398	2208-B600HK	245	2455	233
052477	492	130-1047H	346	173340	107	203411	398	231032	107	280345	171
052478	492	130-1048H	346	173368	107	203412H	398	231034	107	280349-73	171
052479	492	130-1049H	346	173369	107	203413H	398	239995	107	280350-73	171

Article No.	Page(s)	Article No.	Page(s)	Article No.	Page(s)	Article No.	Page(s)	Article No.	Page(s)	Article No.	Page(s)
280351-73	171	340i-32027H	155	363354H	454	41204H	232	41455H	234	430117H	76
280354	171	340i-32050H	153	363355H	454	41205H	232	41456H	234	430185H	66
280360	171	340i-32055H	155	363356	454	41206H	232	41457H	234	430186H	66
280361	171	340i-32057H	155	363357	454	41207H	232	41505	233	430187H	66
280362	171	340i-38110H	153	363358	454	41208H	232	41509	233	430188H	66
280374	108	340i-38115H	155	363359	454	41209H	232	41510	233	430189H	66
280375	108	340i-38116H	155	363414H	398	41210H	232	41513	233	430190H	66
280718	108	340i-38117H	155	363415H	398	41211H	232	41520H	232	430200H	69, 298
280719	108	340i-38118H	155	363428H	131	41212H	232	41920H	49	430201H	69, 298
280871	108	355S-1110	189	363429H	131	41213H	232	41921H	49	430202H	69, 298
280872	108	355S-4000	189	363430H	131	41214H	232	41922H	49	430212H	72
281476	337	355S-4003	189	391572	109	41215H	232	41923H	49	430212H-TF	72
281477	337	355S-4004	189	391573	109	41216H	233	41924H	49	430212H-TK	73
281479	337	360-1001H	344	391589	108	41217H	233	41925H	49	430214H	69
281480	337	360-1002H	344	391590	108	41218H	233	41926H	49	430215H	69
281726	138	360-1003H	344	392720	138	41219H	233	41927H	49	430216H	69
281727	138	360-1004H	344	392721	138	41220H	233	41928H	49	430217H	69
281728	138	360-1005H	344	392723	138	41221H	233	41929H	49	430218H	69
281729	138	360-1006H	344	392724	138	41222H	233	41930H	49	430219H	69
281730	138	360-1007H	344	392725	138	41223H	233	42000H	331	430220H	66
281731	138	360-1008H	344	392726	138	41300H	234	42001H	331	430221H	66
281732	138	360-1009H	344	392727	138	41301H	234	42002H	331	430222H	66
281733	138	360-1010H	344	392728	138	41302H	234	42010H	331	430223H	66
282115R-02	108	360-1011H	344	393104H	207	41303H	234	42020H	331	430224H	66
282116R-02	108	360-1012H	344	393105H	207	41304H	234	42100H	332	430225H	66
282887R	109	360-1013H	344	393127H	207	41305H	234	42101H	332	430226H	66
282888R	109	360-1014H	344	40000H	261	41306H	234	42102H	332	430227H	66
282901	277	360-1015H	344	40001H	261	41307H	234	42103H	332	430228H	66
282902	277	360-1016H	344	40002H	261	41308H	234	42120H	332	430229H	66
282903	277	360-1017H	345	40003H	261	41309H	234	42121H	332	430230H	66
283102HR	207	360-1018H	345	40004H	261	41310H	234	42130H	332	430231H	66
283103HR	207	360-1019H	345	40005H	261	41311H	234	42200H-73	103	430232H	66
283126HR	207	360-1020H	345	40006H	261	41312H	234	42201H-73	103	430233H	66
283345	108	360-1021H	345	40007H	261	41313H	234	42202H-73	103	430234H	66
283346	108	360-1022H	345	40008H	261	41314H	234	42203H-73	103	430235H	66
289358	109	360-1023H	345	40009H	261	41315H	234	42204H-73	103	430236H	66
289359	109	360-1024H	345	40010H	261	41316H	234	42400H	331	430237H	66
289360	109	360-1025H	345	40011H	261	41317H	234	42401H	331	430238H	66
289361	109	360-1026H	345	40012H	261	41318H	234	42402H	331	430239H	66
3201H	391	360-1027H	345	40013H	261	41319H	234	42500H	331	430240H	66
3202H	391	360-1028H	345	40014	261	41320H	234	42501H	331	430241H	66
3203H	391	360-1029H	345	40020H	261	41321H	234	42502H	331	430242H	66
3206H	391	360-1030H	345	40021H	261	41322H	234	42503H	331	430243H	66
3221H	391	360-1031H	345	40022H	261	41323H	234	430064H	71	430244H	67
3222H	391	360-1032H	345	40023H	261	41400H-73	234	430065H	71	430245H	67
3227	391	360-1033H	345	40024H	261	41401H-73	234	430066H	71	430246H	67
3228H	391	360-1034H	345	40025H	261	41402H-73	234	430067H	71	430248H	72
323227H	84	360-1035H	345	40026H	261	41403H-73	234	430068H	71	430249H	67
323228H	84	360-1036H	345	40027H	261	41404H-73	234	430069H	71	430250H	67
323230H	84	360-1037H	345	40028H	261	41405H-73	234	430070H	71	430253H	67
323235H	66	360-1038H	345	40029H	261	41406H	234	430071H	71	430256H	67
323236H	66	360-1039H	345	40030H	261	41407H	234	430072H	71	430257H	67
323237H	66	360-1040H	345	40031H	261	41408H	234	430073H	71	430258H	67
323260	108	360-1041H	346	40032H	261	41409H	234	430074H	71	430261H	67
323261	108	360-1042H	346	40033H	261	41410H	234	430075H	71	430262H	67
323262H	109	360-1043H	346	40034	261	41411H	234	430080H	73	430265H	67
323263H	109	360-1044H	346	40040H	262	41412H	234	430081H	73	430268H	67
323332H	391	360-1045H	346	40041H	262	41413H	234	430082H	73	430269H	67
323395H	271	360-1046H	346	40042H	262	41414H	234	430083H	73	430270H	67
323396H	271	360-1047H	346	40044H	262	41415H	234	430084H	73	430271H	67
323397H	271	360-1048H	346	40047H	262	41420H	234	430085H	73	430272H	67
323418H	479	360-1049H	346	40048H	262	41421H	234	430086H	73	430273H	67
323419H	479	360-1050H	346	40056H	261	41422H	234	430087H	73	430274H	67
323437H	44	360-1111H	344	40057H	261	41423H	234	430088H	73	430275H	67
323438H	44	360-1112H	344	40071H	262	41424H	234	430089H	73	430276H	67
323483H	214	360-1113H	344	410-2008	370	41425H	234	430090H	73	430277H	67
323484H	214	360-1115H	344	410-2016	370	41426H	234	430091H	73	430278H	67
323485H	214	360-1117H	344	410-2023	370	41427H	234	430093H	76	430279H	67
323486H	214	360-1118H	344	410-2033	370	41428H	234	430093H-RE	77	430280H	67
3251H	391	360-1119H	344	410-2038	370	41429H	234	430093H-RER	77	430281H	67
3252H	391	360-1120H	344	410-2039	370	41430H	234	430093H-RERZ	77	430282H	67
3258H	391	360-1121H	344	410-2040	370	41431H	234	430093H-RZ	77	430283H	67
3303H	391	363335	108	410-2041	370	41432H	234	430093H-SE	77	430284H	67
3304H	391	363336	108	410-2042	370	41433H	234	430093H-SZ	77	430285H	67
3305H	391	363347H	283	410-2043	370	41434H	234	430094H	76	430286H	67
3306	391	363348H	283	410-2111	370	41435H	234	430095H	76	430287H	67
3314H	391	363349H	283	410-2113	370	41450H	234	430096H	76	430288H	67
3353H	391	363350H	283	41200H	232	41451H	234	430097H	76	430289H	67
3354H	391	363351H	283	41201H	232	41452H	234	430098H	76	430290H	67
340i-32020H	153	363352H	454	41202H	232	41453H	234	430115H	76	430291H	67
340i-32025H	155	363353H	454	41203H	232	41454H	234	430116H	76	430292H	68

Article No.	Page(s)	Article No.	Page(s)	Article No.	Page(s)	Article No.	Page(s)	Article No.	Page(s)	Article No.	Page(s)
430293H	68	430355H	68	430416H	69	430497H	70	430660	254	430757H	96
430294H	68	430356H	68	430417H	69	430498H	70	430661	254	430758H	96
430295H	68	430357H	68	430418H	69	430499H	70	430662	254	430759H	96
430296H	68	430358H	68	430419H	69	430500H	70	430663	254	430760H	96
430297H	68	430359H	68	430420H	69	430501H	70	430664	254	430761H	96
430298H	68	430360H	68	430421H	69	430502H	70	430665	255	430762H	96
430299H	68	430361H	68	430422	70	430503H	70	430666	255	430763H	96
430300H	68	430362H	68	430423	70	430504H	72	430667	255	430764H	96
430301H	68	430363H	68	430424	70	430505H	72	430668	255	430765H	96
430302H	68	430364H	68	430425	70	430506H	72	430669	255	430766H	96
430303H	68	430365H	68	430426	70	430507H	72	430670	255	430767H	96
430304-N	125	430366H	68	430427	70	430508H	72	430671	255	430768H	96
430304H	68	430367H	68	430428H	70	430509H	72	430672	255	430769H	96
430304H-N	125	430368H	68	430429H	70	430510H	72	430673	255	430770H	96
430304H-N	74	430369H	68	430430H	70	430511H	72	430674	255	430771H	96
430304H-R	74, 125	430370H	68	430431H	70	430512H	72	430675	255	430772H	96
430305H	68	430371H	68	430432H	70	430513H	72	430676	255	430773H	96
430306H	68	430372H	68	430433H	70	430514H	72	430677	255	430774H	96
430307H	68	430373H	68	430434H	70	430515H	72	430678	255	430775H	96
430308H	68	430374H	68	430435H	70	430516H	73	430679	255	430776H	96
430309H	68	430375H	68	430436H	70	430517H	73	430680	255	430777H	96
430310H	68	430380H	69	430437H	70	430518H	73	430681	255	430778H	96
430311H	68	430381H	69	430438H	70	430519H	73	430684	298	430779H	97
430312-N	125	430382H	69	430439H	70	430520H	73	430685	497	430780H	97
430312H	68	430383H	69	430440H	70	430521H	73	430686	497	430781H	97
430312H-N	74, 125	430384H	69	430441H	70	430522H	73	430687	497	430782H	97
430312H-R	74, 125	430385H	69	430442H	70	430523H	73	430688	497	430783H	97
430313H	68	430386H	69	430443H	70	430524H	73	430689	497	430784H	97
430314H	68	430387H	69	430444H	70	430525H	73	430690	497	430785H	97
430315H	68	430388H	69	430445H	70	430526H	73	430691	497	430786H	97
430316H	68	430389H	69	430446H	70	430527H	73	430692	497	430787H	97
430317H	68	430390H	69	430447H	70	430528H	73	430693	497	430788H	97
430318H	68	430391H	69	430448H	70	430529H	73	430694	497	430789H	97
430319H	68	430392H	69	430449H	70	430530H	73	430701H	93	430790H	97
430320H	68	430393H	69	430450H	70	430531H	73	430702H	93	430791H	97
430321H	68	430394H	69	430451H	70	430532H	73	430703H	93	430792H	97
430322H	68	430395H	69	430452H	70	430533H	73	430704H	93	430793H	97
430323H	68	430396H	69	430453H	70	430534H	73	430705H	93	430794H	97
430324H	68	430397H	69	430454H	70	430535H	73	430706H	93	430795H	97
430325H	68	430398H	69	430455H	70	430536H	73	430707H	93	430796H	97
430326H	68	430398H-TF	72	430456H	70	430537H	73	430708H	93	430797H	85
430327H	68	430398H-TK	73	430457H	70	430538H	73	430709H	93	430798H	85
430328H	68	430399H	69	430458H	70	430539H	73	430710H	93	430802H	97
430329H	68	430399H-TF	72	430459H	70	430564H	70	430711H	93	430803H	97
430330H	68	430399H-TK	73	430460H	70	430565H	70	430712H	93	430804H	97
430331H	68	430400H	69	430461H	70	430566H	70	430713H	93	430805H	97
430332H	68	430400H-TF	72	430462H	70	430567H	70	430714H	93	430806H	98
430333H	68	430400H-TK	73	430463H	70	430568H	70	430715H	93	430807H	98
430334H	68	430401H	69	430464H	72	430569H	70	430716H	93	430808H	98
430335H	68	430401H-TF	72	430465H	72	430570H	70	430717H	95	430809H	98
430336H	68	430401H-TK	73	430466H	72	430571H	70	430718H	95	430810H	98
430337H	68	430402H	69	430467H	72	430572H	70	430719H	95	430811H	98
430338H	68	430402H-TF	72	430468H	72	430573H	70	430720H	95	430812H	98
430339H	68	430402H-TK	73	430469H	72	430574H	70	430721H	93	430813H	98
430340H	68	430403H	69	430470H	72	430575H	70	430722H	93	430814H	98
430340H-TK	73	430403H-TF	72	430471H	72	430599H	309	430723H	93	430815H	98
430341H	68	430403H-TK	73	430472H	72	430635	253	430724H	93	430816H	98
430341H-TK	73	430404H	69	430473H	72	430636	253	430725H	93	430817H	98
430342H	68	430404H-TF	72	430474H	72	430637	253	430726H	93	430818H	98
430342H-TK	73	430404H-TK	73	430475H	72	430638	253	430727H	93	430819H	98
430343H	68	430405H	69	430476H	72	430639	253	430728H	93	430820H	98
430343H-TK	73	430405H-TF	72	430476H-TF	72	430640	253	430729H	94	430821H	98
430344H	68	430405H-TK	73	430476H-TK	73	430641	253	430730H	94	430822H	98
430344H-TK	73	430406H	69	430477H	72	430642	253	430731H	94	430823H	98
430345H	68	430406H-TF	72	430480H	70	430643	253	430732H	94	430824H	98
430345H-TK	73	430406H-TK	73	430481H	70	430644	253	430733H	94	430825H	98
430346H	68	430407H	69	430482H	70	430645	254	430734H	94	430826H	99
430346H-TK	73	430407H-TF	72	430483H	70	430646	254	430735H	94	430827H	99
430347H	68	430407H-TK	73	430484H	70	430647	254	430736H	94	430828H	99
430347H-TK	73	430408H	69	430485H	70	430648	254	430737H	95	430829H	99
430348H	68	430408H-TF	72	430486H	70	430649	254	430738H	95	430834H	85
430348H-TK	73	430408H-TK	73	430487H	70	430650	254	430739H	95	430835H	85
430349H	68	430409H	69	430488H	70	430651	254	430740H	95	430836H	85
430349H-TK	73	430409H-TF	72	430489H	70	430652	254	430741H	95	430837H	85
430350H	68	430409H-TK	73	430490H	70	430653	254	430742H	95	430838H	85
430350H-TK	73	430410H	69	430491H	70	430654	254	430743H	95	430839H	85
430351H	68	430411H	69	430492H	70	430655	254	430744H	95	430840H	85
430351H-TK	73	430412H	69	430493H	70	430656	254	430753H	96	430841H	85
430352H	68	430413H	69	430494H	70	430657	254	430754H	96	430842H	85
430353H	68	430414H	69	430495H	70	430658	254	430755H	96	430843H	85
430354H	68	430415H	69	430496H	70	430659	254	430756H	96	430844H	85

Article No.	Page(s)	Article No.	Page(s)	Article No.	Page(s)	Article No.	Page(s)	Article No.	Page(s)	Article No.	Page(s)
430845H	85	430927	119	431116H	287	431489	45	431580H-TF	94	431679H	480
430846H	85	430928	119	431117H	287	431490	45	431581H	94	431680H	480
430847H	85	430929	119	431118H	287	431491	45	431581H-TF	94	431681H	480
430848H	85	430930	119	431119H	287	431492	45	431582H	94	431682H	480
430849H	85	430931	119	431120H	287	431493	45	431583H	94	431683H	480
430850H	85	430932	119	431121H	287	431494	45	431584H	94	431684H	480
430851H	85	430933	119	431122H	287	431495	45	431585H	94	431685H	480
430853	430	430934	119	431320	201	431496	45	431586H	94	431686H	480
430854	430	430935	119	431321	201	431497	45	431587H	94	431687H	481
430855	430	430936	119	431328H	272	431498	45	431601H	399	431688H	481
430856	430	430937	119	431329H	272	431499	45	431602H	399	431689H	481
430857	430	430938	119	431330H	272	431501H	93	431603H	399	431690H	481
430858	430	430939	119	431331H	272	431502H	93	431604H	399	431691H	481
430859	430	430940	119	431332H	272	431503H	93	431605H	399	431692H	299, 480
430860	430	430941	119	431333H	272	431504H	93	431606H	399	431693H	299, 480
430861	430	430942	119	431334H	272	431505H	93	431607H	399	431694H	299, 480
430862	430	430943	119	431335H	272	431506H	93	431608H	399	431695H	480
430863	430	430944	119	431336H	272	431507H	93	431609H	399	431696H	480
430864	430	430945	119	431337H	272	431508H	93	431610H	399	431697H	480
430865	430	430946	120	431338H	272	431509H	93	431611H	399	431715H	309
430866	430	430947	120	431339H	272	431510H	93	431612H	399	431716H	309
430867	430	430948	120	431340H	272	431511H	93	431613H	399	431717H	309
430868	430	430949	120	431341H	272	431512H	93	431614H	399	431718H	309
430869	430	430950	120	431342H	272	431513H	94	431615H	399	431719H	309
430870	430	430951	120	431343H	272	431514H	94	431616H	399	431720H	309
430871	430	430952	120	431344	272	431515H	94	431617H	399	431721H	309
430872	430	430953	120	431345	272	431516H	94	431618H	399	431722H	309
430873	430	430954	120	431346	272	431523H	95	431619H	399	431723H	309
430874	430	430955	120	431347	272	431524H	95	431620H	399	431727H	309
430875	430	430956	120	431348H	272	431525H	95	431621H	399	431736H	309
430876	430	430957	120	431349H	272	431526H	95	431622H	399	431744H	307
430877	430	430958	120	431350H	272	431527H	95	431623H	399	431745H	307
430878	430	430959	120	431351H	272	431528H	95	431624H	399	431746H	307
430879	430	430960	120	431352H	410	431529H	95	431630H	455	431747H	307
430880	430	430963	110	431353H	410	431530H	95	431631H	455	431748H	307
430881	431	430964	110	431354H	410	431531H	95	431632H	455	431749H	307
430882	431	430965	110	431355H	410	431532H	95	431633H	455	431750H	308
430883	431	430966	110	431356H	410	431533H	96	431634H	455	431751H	308
430884	431	430967	110	431357H	410	431534H	96	431635H	455	431752H	308
430885	431	430968	110	431358H	410	431535H	96	431636H	455	431753H	308
430886	431	430977	119, 298	431359H	410	431536H	96	431637H	455	431754H	308
430887	431	430978	119, 298	431363H	410	431537H	96	431638H	455	431755H	308
430888	431	430979	119, 298	431364H	410	431538H	96	431639H	455	431756H	309
430889	431	430984H	95	431365H	410	431539H	96	431640H	455	431757H	309
430890	431	430985H	95	431366H	410	431540H	96	431641H	455	431762H	309
430891	431	430986H	95	431367H	410	431541H	96	431642H	455	431763H	309
430892	431	430987H	95	431368H	410	431542H	96	431643H	455	431765H	309
430893	431	430988H	95	431369H	410	431543H	96	431644H	455	431785H	309
430894	431	430989H	95	431370H	410	431544H	96	431645H	455	431786H	309
430895	431	430990H	95	431371H	410	431545H	96	431647H	480	431787H	309
430896	431	430991H	95	431372H	410	431546H	97	431648H	480	431794H	309
430897	431	430993	118, 298	431373H	410	431547H	97	431649H	480	431797H	309
430898	431	430995	119, 298	431374H	410	431548H	97	431650H	480	431801H	307
430899	431	430996	119, 298	431380	404	431549H	97	431651H	480	431802H	307
430900	431	430997	119, 298	431381	404	431550H	97	431652H	480	431803H	307
430901	118	431006	110	431382	404	431551H	97	431653H	480	431804H	307
430902	118	431007	110	431383	404	431552H	97	431654H	480	431805H	307
430903	118	431008	110	431384	404	431553H	97	431655H	480	431806H	307
430904	118	431009	110	431385	404	431554H	97	431656H	480	431807H	307
430905	118	431020	430	431386	404	431555H	97	431657H	480	431808H	307
430906	118	431021	430	431387	404	431556H	97	431658H	480	431809H	307
430907	118	431022	430	431388	404	431557H	98	431659H	480	431810H	307
430908	118	431023	430	431389	404	431558H	98	431660H	480	431811H	307
430909	118	431024	430	431390	404	431559H	98	431661H	480	431817H	307
430910	118	431025	430	431391	404	431560H	98	431662H	480	431818H	307
430911	118	431026	430	431392	404	431561H	98	431663H	480	431819H	307
430912	118	431027	431	431393	404	431562H	98	431664H	480	431820H	307
430913	118	431028	431	431394	404	431563H	98	431665H	480	431821H	307
430914	118	431029	431	431395H	410	431564H	98	431666H	480	431822H	307
430915	118	431030	431	431396H	410	431565H	98	431667H	480	431823H	307
430916	118	431031	431	431397H	410	431566H	98	431668H	480	431824H	307
430917	118	431045	118	431398H	410	431567H	99	431669H	480	431825H	307
430918	118	431046	118	431480	45	431576H	94	431670H	481	431826H	307
430919	118	431047	118	431481	45	431576H-TF	94	431671H	481	431827H	307
430920	118	431048	118	431482	45	431577H	94	431672H	481	431828H	307
430921	118	431049	118	431483	45	431577H-TF	94	431673H	481	431829H	308
430922	118	431111H	287	431484	45	431578H	94	431674H	481	431830H	308
430923	118	431112H	287	431485	45	431578H-TF	94	431675	481	431831H	308
430924	118	431113H	287	431486	45	431579H	94	431676	481	431832H	308
430925	118	431114H	287	431487	45	431579H-TF	94	431677H	480	431833H	308
430926	119	431115H	287	431488	45	431580H	94	431678H	480	431834H	308

Article No.	Page(s)	Article No.	Page(s)	Article No.	Page(s)	Article No.	Page(s)	Article No.	Page(s)	Article No.	Page(s)
431835H	308	433408	194	433855	194	435317H	466	435455H-TF	464	435603H	75
431836H	308	433410	194	433856	194	435318H	466	435455H-TK	465	435604H	75
431837H	308	433411	194	433891	486	435319H	466	435456H	464	435605H	75
431838H	308	433412	194	434194	298	435320H	466	435456H-TF	464	435606H	75
431839H	308	433430	194	434216	200	435321H	466	435456H-TK	465	435607H	75
431840H	308	433432	194	434217	200	435322H	466	435457H	464	435608H	75
431841H	308	433434	194	434218	200	435323H	466	435457H-TF	464	435609H	75
431842H	308	433436	194	434219	200	435324H	466	435457H-TK	465	435610H	75
431843H	308	433438	194	434220	200	435372H	463	435458H	464	435611H	75
431844H	308	433440	194	434221	200	435373H	463	435458H-TF	464	435612H	75
431845H	308	433442	194	434222	200	435374H	463	435458H-TK	465	435613H	75
431846H	308	433660	194	434223	200	435375H	463	435459H	464	435614H	75
431847H	308	433661	194	434224	200	435376H	463	435459H-TF	464	435615H	75
431848H	308	433662	194	434225	200	435377H	463	435459H-TK	465	435616H	75
431849H	308	433664	194	434226	200	435378H	463	435460H	464	435617H	75
431850H	308	433665	194	434227	200	435379H	463	435461H	464	435618H	75
431851H	308	433666	194	434228	200	435380H	463	435462H	464	435619H	75
431852H	309	433671	486	434229	200	435381H	463	435463H	464	435620H	75
431853H	309	433672	486	434230	200	435382H	463	435464H	464	435621H	75
431854H	309	433673	486	434231	200	435383H	463	435465H	464	435622H	75
431855H	309	433674	486	434232	200	435384H	463	435466H	464	435623H	75
431856H	309	433678	487	434233	200	435385H	463	435467H	464	435624H	75
431857H	309	433679	487	434234	200	435386H	463	435468H	464	435625H	75
431864H	309	433680	487	434235	200	435387H	463	435468H-TF	464	435626H	75
431865H	309	433681	487	434236	200	435397H	463	435468H-TK	465	435627H	75
431866H	309	433685	487	434237	200	435398H	463	435469H	464	435628H	75
431867H	309	433686	487	434238	200	435399H	463	435469H-TF	464	435629H	75
431868H	309	433687	487	434239	200	435400H	463	435469H-TK	465	435630H	75
431869H	309	433688	487	434240	200	435401H	463	435470H	464	435631H	75
431873H	307	433692	139	434241	200	435402H	463	435470H-TF	464	435632H	75
431874H	307	433693	139	434248	201	435403H	463	435470H-TK	465	435633H	75
431875H	307	433694	139	434249	201	435404H	463	435471H	464	435634H	75
431876H	307	433695	139	434250	201	435409H	463	435471H-TF	464	435635H	75
431877H	307	433696	139	434251	201	435410H	463	435471H-TK	465	435636H	75
431887H	309	433697	139	434252	201	435411H	463	435472H	464	435637H	75
431893H	309	433701	487	434253	201	435412H	463	435472H-TF	464	435638H	75
431894H	309	433702	487	434256	200	435413H	463	435472H-TK	465	435639H	75
431913	207	433703	487	434328	200	435414H	463	435473H	464	435640H	75
431914	207	433704	487	434330	200	435415H	463	435473H-TF	464	435641H	75
431915	207	433730	194	434332	200	435416H	463	435473H-TK	465	435642H	75
431919H	207	433731	194	434334	200	435417H	463	435474H	464	435643H	75
431920	207	433732	194	434336	200	435418H	463	435474H-TF	464	435644H	75
431921	207	433733	194	434342	201	435419H	463	435474H-TK	465	435645H	75
431922	207	433734	194	434344	201	435420H	463	435475H	464	435646H	75
431965H	480	433735	194	434432	487	435421H	463	435475H-TF	464	435647H	75
431966H	480	433756	139	434433	487	435422H	463	435475H-TK	465	435648H	75
431967H	480	433757	139	434434	487	435423H	463	435476H	464	435649H	75
432027	201	433758	139	434435	487	435424H	463	435477H	464	435650H	75
432028	201	433770	486	434976	200	435428H	463	435478H	464	435651H	75
432029	201	433771	486	434977	200	435428H-TK	465	435479H	464	435652H	75
432030	201	433772	486	434978	200	435429H	463	435480H	464	435653H	75
432033	201	433773	486	434979	200	435429H-TK	465	435481H	464	435654H	75
432034	201	433778	486	434980	201	435430H	463, 465	435482H	464	435655H	75
432035	201	433779	486	434981	201	435431H	463	435483H	464	435656H	75
432036	201	433780	486	434983H	45	435431H-TK	465	435484H	465	435657H	75
432039	201	433781	486	434984H	45	435432H	463	435485H	465	435658H	75
432040	201	433786	486	434985H	45	435432H-TK	465	435486H	465	435659H	75
432041	201	433787	486	434986H	455	435433H	463	435487H	465	435660H	75
432042	201	433789	486	434987H	455	435433H-TK	465	435488H	465	435661H	75
432045	201	433793	486	434988H	455	435434H	463	435489H	465	435662H	75
432046	201	433794	486	434989H	455	435434H-TK	465	435490H	465	435663H	75
432047	201	433795	486	435026	200	435435H	463	435491H	465	435664H	75
432048	201	433796	486	435027	200	435435H-TK	465	435492H	466	435665H	75
432292	298	433802	194	435028	200	435436H	464	435493H	466	435666H	75
432293	298	433803	194	435029	200	435437H	464	435494H	466	435667H	75
432294	298	433804	194	435301H	463	435438H	464	435495H	466	435668H	75
432323	455	433806	194	435302H	463	435439H	464	435496H	466	435669H	75
432324	455	433807	194	435303H	463	435440H	464	435497H	466	435670H	75
432325	455	433808	194	435304H	463	435441H	464	435498H	466	435671H	75
432326	455	433817	194	435305H	463	435442H	464	435499H	466	435672H	75
432335H	454	433819	194	435306H	463	435443H	464	435569H	66	435673H	75
432336H	454	433821	194	435307H	463	435452H	464	435570H	67	435674H	75
432337H	454	433823	194	435308H	463	435452H-TF	464	435571H	67	435675H	75
432338H	454	433841	486	435309H	466	435452H-TK	465	435572H	67	435676H	75
432805-HKS	194	433842	486	435310H	466	435453H	464	435573H	67	435677H	75
432805-IE	194	433843	486	435311H	466	435453H-TF	464	435574H	67	435678H	75
433402	194	433844	486	435312H	466	435453H-TK	465	435575H	67	435679H	75
433403	194	433850	194	435313H	466	435454H	464	435576H	69	435680H	75
433404	194	433851	194	435314H	466	435454H-TF	464	435577H	69	435681H	75
433406	194	433852	194	435315H	466	435454H-TK	465	435601H	75	435682H	75
433407	194	433854	194	435316H	466	435455H	464	435602H	75	435683H	75

Article No.	Page(s)	Article No.	Page(s)	Article No.	Page(s)	Article No.	Page(s)	Article No.	Page(s)	Article No.	Page(s)
435684H	75	435949H	443	436132H	421	436235H	320	538021-400	107	552007-341550HK	351
435685H	72	435950H	443	436133H	421	436236H	320	538260-400	107	552007-342550HK	352
435685H-TF	72	435951H	443	436134H	421	436237H	320	538261-400	107	552007-352010HK	351
435685H-TK	73	435952H	443	436135H	421	436238H	320	538280-400	107	552007-352050HK	352
435686H	72	435953H	443	436136H	421	436239H	320	538281-400	107	552007-41550HK	146
435686H-TF	72	435954H	443	436137H	421	436240H	320	552001-12020H	146	552007-42550HK	146
435686H-TK	73	435955H	443	436138H	421	436241H	320	552001-12023H	147	552008-12020H	146
435687H	72	435956H	443	436139H	421	436242H	320	552001-12050H	146	552008-12050H	146
435687H-TF	72	435957H	443	436140H	421	436243H	320	552001-12053H	147	552008-18120H	146
435687H-TK	73	435958H	443	436141H	421	44400H	332	552001-18120H	146	552008-18210H	146
435688H	72	435959H	443	436142H	421	44401H	332	552001-18123H	147	552008-341550HK	351
435688H-TF	72	435960H	443	436143H	421	44425H	332	552001-18124H	147	552008-342550HK	352
435688H-TK	73	435961H	443	436144H	422	44447H	332	552001-18210H	146	552008-352010HK	351
435689H	72	435962H	443	436145H	422	44448H	332	552001-18213H	147	552008-352050HK	352
435689H-TF	72	435963H	443	436146H	422	44449H	332	552001-18214H	147	552008-41550HK	146
435689H-TK	73	435964H	443	436147H	422	44500H	332	552001-341550HK	351	552008-42550HK	146
435690H	72	435965H	443	436148H	422	44501H	332	552001-342550HK	352	552009-12020H	146
435690H-TF	72	435966H	443	436149H	422	45550H	185	552001-352010HK	351	552009-12050H	146
435690H-TK	73	435967H	443	436150H	422	45551H	185	552001-352050HK	352	552009-18120H	146
435691H	72	435968H	443	436151H	422	45552H	185	552001-41550HK	146	552009-18210H	146
435691H-TF	72	435969H	443	436152H	422	45553H	185	552001-42550HK	146	552009-341550HK	351
435691H-TK	73	435970H	443	436153H	422	45554H	185	552002-12020H	146	552009-342550HK	352
435692H	72	435971H	443	436154H	422	45555H	185	552002-12023H	147	552009-352010HK	351
435692H-TF	72	435972H	444	436155H	422	45556H	185	552002-12050H	146	552009-352050HK	352
435692H-TK	73	435973H	444	436156H	420	45557H	185	552002-12053H	147	552009-41550HK	146
435693H	72	435974H	444	436157H	420	45600H	185	552002-18120H	146	552009-42550HK	146
435693H-TF	72	435975H	444	436158H	420	45601H	185	552002-18123H	147	552010-12020H	146
435693H-TK	73	435976H	444	436159H	420	45602H	185	552002-18124H	147	552010-12050H	146
435694H	72	435977H	444	436160H	420	45603H	185	552002-18210H	146	552010-18120H	146
435694H-TF	72	435978H	444	436161H	420	45604H	185	552002-18213H	147	552010-18210H	146
435694H-TK	73	435979H	444	436162H	420	45605H	185	552002-18214H	147	552010-341550HK	351
435695H	72	435980H	444	436163H	420	45606H	185	552002-341550HK	351	552010-342550HK	352
435696H	72	435981H	444	436164H	420	45607H	185	552002-342550HK	352	552010-352010HK	351
435697H	72	435982H	444	436165H	420	47050H	241	552002-352010HK	351	552010-352050HK	352
435698H	72	435983H	444	436166H	420	47051H	241	552002-352050HK	352	552010-41550HK	146
435699H	72	435984H	444	436167H	420	47052H	241	552002-41550HK	146	552010-42550HK	146
435700H	72	435985H	444	436168H	421	47053H	241	552002-42550HK	146	552011-12020H	146
435701H	72	435986H	444	436169H	421	47054H	241	552003-12020H	146	552011-12050H	146
435702H	72	435987H	444	436170H	421	47075H	241	552003-12050H	146	552011-18120H	146
435703H	72	435988H	444	436171H	421	47076H	241	552003-18120H	146	552011-18210H	146
435704H	72	435989H	444	436172H	421	47077H	241	552003-18210H	146	552011-341550HK	351
435901H	215	435990H	444	436173H	421	47078H	241	552003-341550HK	351	552011-342550HK	352
435902H	215	435991H	444	436174H	421	47079H	241	552003-342550HK	352	552011-352010HK	351
435903H	215	435992H	444	436175H	421	47250H	241	552003-352010HK	351	552011-352050HK	352
435904H	215	435993H	444	436176H	421	47251H	241	552003-352050HK	352	552011-41550HK	146
435905H	215	435994H	444	436177H	421	47252H	241	552003-41550HK	146	552011-42550HK	146
435906H	215	435995H	444	436178H	421	47253H	241	552003-42550HK	146	552012-12020H	146
435907H	215	435996H	444	436179H	421	47254H	241	552004-12020H	146	552012-12050H	146
435908H	215	435997H	444	436180H	422	47255H	241	552004-12050H	146	552012-18120H	146
435909H	215	435998H	444	436181H	422	47256H	241	552004-18120H	146	552012-18210H	146
435910H	215	435999H	444	436182H	422	47257H	241	552004-18210H	146	552012-341550HK	351
435911H	215	436100	112	436183H	422	47258H	241	552004-341550HK	351	552012-342550HK	352
435912H	215	436101	112	436184H	422	47259H	241	552004-342550HK	352	552012-352010HK	351
435913H	215	436102	112	436185H	422	47275H	241	552004-352010HK	351	552012-352050HK	352
435914H	215	436103	112	436186H	422	47276H	241	552004-352050HK	352	552012-41550HK	146
435915H	215	436104	112	436187H	422	47277H	241	552004-41550HK	146	552012-42550HK	146
435916H	215	436105	112	436188H	422	47278H	241	552004-42550HK	146	552013-12020H	148
435917H	215	436106	112	436189H	422	47279H	241	552005-12020H	146	552013-12050H	148
435918H	215	436107	112	436190H	422	47280H	241	552005-12050H	146	552013-18120H	148
435919H	215	436110H	420	436191H	422	47281H	241	552005-18120H	146	552013-18210H	148
435920H	215	436111H	420	436192H	422	47282H	241	552005-18210H	146	552013-341550HK	351
435921H	215	436112H	420	436193H	422	47283H	241	552005-341550HK	351	552013-342550HK	352
435922H	215	436113H	420	436194H	422	47284H	241	552005-342550HK	352	552013-352010HK	351
435923H	215	436114H	420	436195H	422	47650H	241	552005-352010HK	351	552013-352050HK	352
435924H	215	436115H	420	436196H	422	47651H	241	552005-352050HK	352	552013-41550HK	148
435925H	215	436116H	420	436197H	422	47652H	241	552005-41550HK	146	552013-42550HK	148
435926H	216	436117H	420	436220H	320	47653H	241	552005-42550HK	146	552014-12020H	148
435927H	216	436118H	420	436221H	320	47654H	241	552006-12020H	146	552014-12050H	148
435928H	216	436119H	420	436222H	320	47655H	241	552006-12050H	146	552014-18120H	148
435929H	216	436120H	420	436223H	320	47656H	241	552006-18120H	146	552014-18210H	148
435930H	216	436121H	420	436224H	320	47657H	241	552006-18210H	146	552014-341550HK	351
435931H	216	436122H	420	436225H	320	47658H	241	552006-341550HK	351	552014-342550HK	352
435932H	216	436123H	420	436226H	320	47659H	241	552006-342550HK	352	552014-352010HK	351
435933H	216	436124H	420	436227H	320	509-18120	113	552006-352010HK	351	552014-352050HK	352
435934H	216	436125H	420	436228H	320	531910-148	107	552006-352050HK	352	552014-41550HK	148
435935H	216	436126H	420	436229H	320	531911-148	107	552006-41550HK	146	552014-42550HK	148
435936H	216	436127H	420	436230H	320	532212-800	107	552006-42550HK	146	552015-12020H	148
435937H	216	436128H	421	436231H	320	532230-800	107	552007-12020H	146	552015-12050H	148
435938H	216	436129H	421	436232H	320	533434-198	108	552007-12050H	146	552015-18120H	148
435939H	216	436130H	421	436233H	320	533436-198	108	552007-18120H	146	552015-18210H	148
435948H	443	436131H	421	436234H	320	538020-400	107	552007-18210H	146	552015-341550HK	351

Article No.	Page(s)	Article No.	Page(s)	Article No.	Page(s)	Article No.	Page(s)	Article No.	Page(s)	Article No.	Page(s)
552015-342550HK	352	552023-352010HK	353	552031-352050HK	354	552039-41550HK	149	553001-38117H	155	553039-38110H	154
552015-352010HK	351	552023-352050HK	354	552031-41550HK	148	552039-42550HK	149	553001-38118H	155	553040-32020H	154
552015-352050HK	352	552023-41550HK	148	552031-42550HK	148	552040-12020H	149	553002-32020H	153	553040-32050H	154
552015-41550HK	148	552023-42550HK	148	552032-12020H	148	552040-12050H	149	553002-32025H	155	553040-38110H	154
552015-42550HK	148	552024-12020H	148	552032-12050H	148	552040-18120H	149	553002-32027H	155	553112-32020H	154
552016-12020H	148	552024-12050H	148	552032-18120H	148	552040-18120H	149	553002-32050H	153	553112-32050H	154
552016-12050H	148	552024-18120H	148	552032-18210H	148	552040-341550HK	353	553002-32055H	155	553112-38110H	154
552016-18120H	148	552024-18210H	148	552032-341550HK	353	552040-342550HK	354	553002-32057H	155	553113-32020H	154
552016-18210H	148	552024-341550HK	353	552032-342550HK	354	552040-352010HK	353	553002-38110H	153	553113-32050H	154
552016-341550HK	351	552024-342550HK	354	552032-352010HK	353	552040-352050HK	354	553002-38115H	155	553113-38110H	154
552016-342550HK	352	552024-352010HK	353	552032-352050HK	354	552040-41550HK	149	553002-38116H	155	553115-32020H	154
552016-352010HK	351	552024-352050HK	354	552032-41550HK	148	552040-42550HK	149	553002-38117H	155	553115-32050H	154
552016-352050HK	352	552024-41550HK	148	552032-42550HK	148	552112-12020H	146	553002-38118H	155	553115-38110H	154
552016-41550HK	148	552024-42550HK	148	552033-12020H	149	552112-12050H	146	553003-32020H	153	553117-32020H	154
552016-42550HK	148	552025-12020H	148	552033-12050H	149	552112-18120H	146	553003-32050H	153	553117-32050H	154
552017-12020H	148	552025-12050H	148	552033-18120H	149	552112-18210H	146	553003-38110H	153	553117-38110H	154
552017-12050H	148	552025-18120H	148	552033-18210H	149	552112-341550HK	351	553004-32020H	153	553118-32020H	154
552017-18120H	148	552025-18210H	148	552033-341550HK	353	552112-342550HK	352	553004-32050H	153	553118-32050H	154
552017-18210H	148	552025-341550HK	353	552033-342550HK	354	552112-352010HK	351	553004-38110H	153	553118-38110H	154
552017-341550HK	353	552025-342550HK	354	552033-352010HK	353	552112-352050HK	352	553006-32020H	153	553119-32020H	154
552017-342550HK	354	552025-352010HK	353	552033-352050HK	354	552112-41550HK	146	553006-32050H	153	553119-32050H	154
552017-352010HK	353	552025-352050HK	354	552033-41550HK	149	552112-42550HK	146	553006-38110H	153	553119-38110H	154
552017-352050HK	354	552025-41550HK	148	552033-42550HK	149	552113-12020H	146	553007-32020H	153	554001-32020H	157
552017-41550HK	148	552025-42550HK	148	552034-12020H	149	552113-12050H	146	553007-32050H	153	554001-32025H	158
552017-42550HK	148	552026-12020H	148	552034-12050H	149	552113-18120H	146	553007-38110H	153	554001-32027H	158
552018-12020H	148	552026-12050H	148	552034-18120H	149	552113-18210H	146	553008-32020H	153	554001-32050H	158
552018-12050H	148	552026-18120H	148	552034-18210H	149	552113-341550HK	351	553008-32050H	153	554001-32055H	158
552018-18120H	148	552026-18210H	148	552034-341550HK	353	552113-342550HK	352	553008-38110H	153	554001-32057H	158
552018-18210H	148	552026-341550HK	353	552034-342550HK	354	552113-352010HK	351	553010-32020H	153	554001-38110H	157
552018-341550HK	353	552026-342550HK	354	552034-352010HK	353	552113-352050HK	352	553010-32050H	153	554001-38115H	158
552018-342550HK	354	552026-352010HK	353	552034-352050HK	354	552113-41550HK	146	553010-38110H	153	554001-38116H	158
552018-352010HK	353	552026-352050HK	354	552034-41550HK	149	552113-42550HK	146	553011-32020H	153	554001-38117H	158
552018-352050HK	354	552026-41550HK	148	552034-42550HK	149	552115-12020H	146	553011-32050H	153	554001-38118H	158
552018-41550HK	148	552026-42550HK	148	552035-12020H	149	552115-12050H	146	553011-38110H	153	554002-32020H	157
552018-42550HK	148	552027-12020H	148	552035-12050H	149	552115-18120H	146	553014-32020H	153	554002-32025H	158
552019-12020H	148	552027-12050H	148	552035-18120H	149	552115-18210H	146	553014-32050H	153	554002-32027H	158
552019-12050H	148	552027-18120H	148	552035-18210H	149	552115-341550HK	351	553014-38110H	153	554002-32050H	157
552019-18120H	148	552027-18210H	148	552035-341550HK	353	552115-342550HK	352	553015-32020H	153	554002-32055H	158
552019-18210H	148	552027-341550HK	353	552035-342550HK	354	552115-352010HK	351	553015-32050H	153	554002-32057H	158
552019-341550HK	353	552027-342550HK	354	552035-352010HK	353	552115-352050HK	352	553015-38110H	153	554002-38110H	157
552019-342550HK	354	552027-352010HK	353	552035-352050HK	354	552115-41550HK	146	553016-32020H	153	554002-38115H	158
552019-352010HK	353	552027-352050HK	354	552035-41550HK	149	552115-42550HK	146	553016-32050H	153	554002-38116H	158
552019-352050HK	354	552027-41550HK	148	552035-42550HK	149	552117-12020H	146	553016-38110H	153	554002-38117H	158
552019-41550HK	148	552027-42550HK	148	552036-12020H	149	552117-12050H	146	553018-32020H	153	554002-38118H	158
552019-42550HK	148	552028-12020H	148	552036-12050H	149	552117-18120H	146	553018-32050H	153	554003-32020H	157
552020-12020H	148	552028-12050H	148	552036-18120H	149	552117-18210H	146	553018-38110H	153	554003-32050H	157
552020-12050H	148	552028-18120H	148	552036-18210H	149	552117-341550HK	351	553019-32020H	153	554003-38110H	157
552020-18120H	148	552028-18210H	148	552036-341550HK	353	552117-342550HK	352	553019-32050H	153	554004-32020H	157
552020-18210H	148	552028-341550HK	353	552036-342550HK	354	552117-352010HK	351	553019-38110H	153	554004-32050H	157
552020-341550HK	353	552028-342550HK	354	552036-352010HK	353	552117-352050HK	352	553023-32020H	153	554004-38110H	157
552020-342550HK	354	552028-352010HK	353	552036-352050HK	354	552117-41550HK	146	553023-32050H	153	554006-32020H	157
552020-352010HK	353	552028-352050HK	354	552036-41550HK	149	552117-42550HK	146	553023-38110H	153	554006-32050H	157
552020-352050HK	354	552028-41550HK	148	552036-42550HK	149	552118-12020H	146	553026-32020H	153	554006-38110H	157
552020-41550HK	148	552028-42550HK	148	552037-12020H	149	552118-12050H	146	553026-32050H	153	554007-32020H	157
552020-42550HK	148	552029-12020H	148	552037-12050H	149	552118-18120H	146	553026-38110H	153	554007-32050H	157
552021-12020H	148	552029-12050H	148	552037-18120H	149	552118-18210H	146	553027-32020H	153	554007-38110H	157
552021-12050H	148	552029-18120H	148	552037-18210H	149	552118-341550HK	351	553027-32050H	153	554008-32020H	157
552021-18120H	148	552029-18210H	148	552037-341550HK	353	552118-342550HK	352	553027-38110H	153	554008-32050H	157
552021-18210H	148	552029-341550HK	353	552037-342550HK	354	552118-352010HK	351	553031-32020H	153	554008-38110H	157
552021-341550HK	353	552029-342550HK	354	552037-352010HK	353	552118-352050HK	352	553031-32050H	153	554010-32020H	157
552021-342550HK	354	552029-352010HK	353	552037-352050HK	354	552118-41550HK	146	553031-38110H	153	554010-32050H	157
552021-352010HK	353	552029-352050HK	354	552037-41550HK	149	552118-42550HK	146	553033-32020H	153	554010-38110H	157
552021-352050HK	354	552029-41550HK	148	552037-42550HK	149	552119-12020H	146	553033-32050H	153	554011-32020H	157
552021-41550HK	148	552029-42550HK	148	552038-12020H	149	552119-12050H	146	553033-38110H	153	554011-32050H	157
552021-42550HK	148	552030-12020H	148	552038-12050H	149	552119-18120H	146	553034-32020H	153	554011-38110H	157
552022-12020H	148	552030-12050H	148	552038-18120H	149	552119-18210H	146	553034-32050H	153	554014-32020H	157
552022-12050H	148	552030-18120H	148	552038-18210H	149	552119-341550HK	351	553034-38110H	153	554014-32050H	157
552022-18120H	148	552030-18210H	148	552038-341550HK	353	552119-342550HK	352	553035-32020H	153	554014-38110H	157
552022-18210H	148	552030-341550HK	353	552038-342550HK	354	552119-352010HK	351	553035-32050H	153	554015-32020H	157
552022-341550HK	353	552030-342550HK	354	552038-352010HK	353	552119-352050HK	352	553035-38110H	153	554015-32050H	157
552022-342550HK	354	552030-352010HK	353	552038-352050HK	354	552119-41550HK	146	553036-32020H	153	554015-38110H	157
552022-352010HK	353	552030-352050HK	354	552038-41550HK	149	552119-42550HK	146	553036-32050H	153	554016-32020H	157
552022-352050HK	354	552030-41550HK	148	552038-42550HK	149	553001-32020H	153	553036-38110H	153	554016-32050H	157
552022-41550HK	148	552030-42550HK	148	552039-12020H	149	553001-32025H	155	553037-32020H	154	554016-38110H	157
552022-42550HK	148	552031-12020H	148	552039-12050H	149	553001-32027H	155	553037-32050H	154	554019-32050H	157
5520											

Article No.	Page(s)	Article No.	Page(s)	Article No.	Page(s)	Article No.	Page(s)	Article No.	Page(s)	Article No.	Page(s)
554026-32050H	157	555038-27182H	166	590-37040-21	189	620290-072	111	702-2019H	353	705-2004H	351
554026-38110H	157	555038-32020H	164	590-37042-21	189	620290-073	111	702-2020H	353	705-2005H	351
554027-32020H	157	555038-32050H	164	590-37043-21	189	620290-075	111	702-2022H	353	705-2006H	351
554027-32050H	157	555038-32080H	165	590-37044-21	189	620296-070	111	702-2023H	353	705-2007H	351
554027-38110H	157	555038-32100H	165	600334-070	112	620296-072	111	702-2024H	353	705-2008H	351
554031-32020H	157	555038-34090H	165	600334-072	112	620296-075	111	702-2026H	353	705-2009H	351
554031-32050H	157	555038-38110H	164	600334-073	112	620450-070	111	702-2027H	353	705-2010H	351
554031-38110H	157	555038-42550HK	164	600334-075	112	620450-072	111	702-2028H	353	705-2011H	351
554035-32020H	157	555038-42580HK	165	600355-103-70	125	620450-073	111	702-2030H	353	705-2012H	351
554035-32050H	157	555039-27180H	166	600355-106-70	125	620450-075	111	702-2031H	353	705-2013H	351
554035-38110H	157	555039-27181H	166	600356-103-70	125	620460-070	111	702-2032H	353	705-2014H	351
554036-32020H	157	555039-27182H	166	600356-106-70	125	620460-072	111	702-2034H	353	705-2015H	351
554036-32050H	157	555039-42580HK	164	600357-103-70	125	620460-073	111	702-2035H	353	705-2016H	351
554036-38110H	157	555039-32050H	164	600357-106-70	125	620460-075	111	702-2036H	353	705-2017H	353
554038-32020H	157	555039-32080H	165	600384-070	112	620470-070	111	702-2038H	353	705-2018H	353
554038-32050H	157	555039-32100H	165	600384-072	112	620470-072	111	702-2039H	353	705-2019H	353
554038-38110H	157	555039-34090H	165	600384-073	112	620470-073	111	702-2040H	353	705-2020H	353
554039-32020H	157	555039-38110H	164	600384-075	112	620470-075	111	702-2111H	351	705-2021H	353
554039-32050H	157	555039-42550HK	164	600416-070	112	620480-072	111	702-2112H	351	705-2022H	353
554039-38110H	157	555039-42580HK	165	600416-072	112	620480-075	111	702-2113H	351	705-2023H	353
554040-32020H	157	555040-27180H	166	600416-073	112	620490-072	111	702-2114H	351	705-2024H	353
554040-32050H	157	555040-27181H	166	600416-075	112	620490-075	111	702-2115H	351	705-2025H	353
554040-38110H	157	555040-27182H	166	600417-070	112	620510-070	111	702-2116H	351	705-2026H	353
554111-32020H	157	555040-32020H	164	600417-072	112	620510-072	111	702-2117H	351	705-2027H	353
554111-32025H	158	555040-32050H	164	600417-073	112	620510-073	111	702-2118H	351	705-2028H	353
554111-32027H	158	555040-32080H	165	600417-075	112	620510-075	111	702-2119H	351	705-2029H	353
554111-32050H	157	555040-32100H	165	600420-070	112	620805-504	110	702-2120H	351	705-2030H	353
554111-32055H	158	555040-34090H	165	600420-072	112	620805-505	110	703-18120	113	705-2031H	353
554111-32057H	158	555040-38110H	164	600420-073	112	620806-504	110	703-2001H	351	705-2032H	353
554111-38110H	157	555040-42550HK	164	600420-075	112	620806-505	110	703-2002H	351	705-2033H	353
554111-38115H	158	555040-42580HK	165	600430-070-71	112	620811-504	110	703-2003H	351	705-2034H	353
554111-38116H	158	555113-27180H	166	600430-072-71	112	620811-505	110	703-2004H	351	705-2035H	353
554111-38117H	158	555113-27181H	166	600430-075-71	112	700-18120	113	703-2005H	351	705-2036H	353
554111-38118H	158	555113-27182H	166	600442-070	112	700-38110	113	703-2006H	351	705-2037H	353
554113-32020H	157	555113-32020H	164	600442-072	112	700i-12020H	146	703-2007H	351	705-2038H	353
554113-32050H	157	555113-32050H	164	600442-073	112	700i-12023H	147	703-2008H	351	705-2039H	353
554113-38110H	157	555113-32080H	165	600442-075	112	700i-12050H	146	703-2009H	351	705-2040H	353
554117-32020H	157	555113-32100H	165	600443-070	112	700i-12053H	147	703-2010H	351	705-2111H	351
554117-32050H	157	555113-34090H	165	600443-072	112	700i-18120H	146	703-2011H	351	705-2112H	351
554117-38110H	157	555113-38110H	164	600443-073	112	700i-18123H	147	703-2012H	351	705-2113H	351
554118-32020H	157	555113-42550HK	164	600443-075	112	700i-18124H	147	703-2013H	351	705-2114H	351
554118-32050H	157	555113-42580HK	165	600450-070	112	700i-18210H	146	703-2014H	351	705-2115H	351
554118-38110H	157	555117-27180H	166	600450-072	112	700i-18213H	147	703-2015H	351	705-2116H	351
554119-32020H	157	555117-27181H	166	600450-073	112	700i-18214H	147	703-2016H	351	705-2117H	351
554119-32050H	157	555117-27182H	166	600450-075	112	700i-341550HK	351	703-2017H	353	705-2118H	351
554119-38110H	157	555117-32020H	164	600499-070	112	700i-342550HK	352	703-2018H	353	705-2119H	351
555023-27180H	166	555117-32050H	164	600499-072	112	700i-352010HK	351	703-2019H	353	705-2120H	351
555023-27181H	166	555117-32080H	165	600499-073	112	700i-352050HK	352	703-2020H	353	705-2121H	351
555023-27182H	166	555117-32100H	165	600499-075	112	700i-41550HK	146	703-2021H	353	710-2001H	351
555023-32020H	164	555117-34090H	165	600859-504	110	700i-42550HK	146	703-2022H	353	710-2002H	351
555023-32050H	164	555117-38110H	164	600859-505	110	701-18120	113	703-2023H	353	710-2003H	351
555023-32080H	165	555117-42550HK	164	600864-504	110	701-38110	113	703-2024H	353	710-2004H	351
555023-32100H	165	555117-42580HK	165	600864-505	110	701i-12020H	146	703-2025H	353	710-2005H	351
555023-34090H	165	555118-27180H	166	601500-070-71	111	701i-12023H	147	703-2026H	353	710-2006H	351
555023-38110H	164	555118-27181H	166	601500-072-71	111	701i-12050H	146	703-2027H	353	710-2007H	351
555023-42550HK	164	555118-27182H	166	601500-075-71	111	701i-12053H	147	703-2028H	353	710-2008H	351
555023-42580HK	165	555118-32020H	164	601550-070-71	111	701i-18120H	146	703-2029H	353	710-2009H	351
555035-27180H	166	555118-32050H	164	601550-072-71	111	701i-18123H	147	703-2030H	353	710-2010H	351
555035-27181H	166	555118-32080H	165	601550-075-71	111	701i-18124H	147	703-2031H	353	710-2011H	351
555035-27182H	166	555118-32100H	165	610-2008	370	701i-18210H	146	703-2032H	353	710-2012H	351
555035-32020H	164	555118-34090H	165	610-2016	370	701i-18213H	147	703-2033H	353	710-2013H	351
555035-32050H	164	555118-38110H	164	610-2023	370	701i-18214H	147	703-2034H	353	710-2014H	351
555035-32080H	165	555118-42550HK	164	610-2033	370	701i-341550HK	351	703-2035H	353	710-2015H	351
555035-32100H	165	555118-42580HK	165	610-2038	370	701i-342550HK	352	703-2036H	353	710-2016H	351
555035-34090H	165	563-18120	113	610-2039	370	701i-352010HK	351	703-2037H	353	710-2017H	353
555035-38110H	164	5716-341550HK	351	610-2040	370	701i-352050HK	352	703-2038H	353	710-2018H	353
555035-42550HK	164	5716-342550HK	352	610-2041	370	701i-41550HK	146	703-2039H	353	710-2019H	353
555035-42580HK	165	5716-352010HK	351	610-2042	370	701i-42550HK	146	703-2040H	353	710-2020H	353
555036-27180H	166	5716-352050HK	352	610-2043	370	702-2002H	351	703-2111H	351	710-2021H	353
555036-27181H	166	5716-41550HK	146	610-2111	370	702-2003H	351	703-2112H	351	710-2022H	353
555036-27182H	166	5716i-12020H	146	610-2113	370	702-2004H	351	703-2113H	351	710-2023H	353
555036-32020H	164	5716i-12023H	147	620241-070	111	702-2006H	351	703-2115H	351	710-2024H	353
555036-32050H	164	5716i-12050H	146	620241-072	111	702-2007H	351	703-2117H	351	710-2025H	353
555036-32080H	165	5716i-12053H	147	620241-073	111	702-2008H	351	703-2118H	351	710-2026H	353
555036-32100H	165	5716i-18120H	146	620241-075	111	702-2010H	351	703-2119H	351	710-2027H	353
555036-34090H	165	5716i-18123H	147	620245-072	111	702-2011H	351	703-2120H	351	710-2028H	353
555036-38110H	164	5716i-18124H	147	620249-070	111	702-2012H	351	703-2121H	351	710-2029H	353
555036-42550HK	164	5716i-18210H	146	620249-072	111	702-2014H	351	703-38110	113	710-2030H	353
555036-42580HK	165	5716i-18213H	147	620249-073	111	702-2015H	351	705-2001H	351	710-2031H	353
555038-27180H	166	5716i-18214H	147	620249-075	111	702-2016H	351	705-2002H	351	710-2032H	353
555038-27181H	166	5716i-42550HK	146	620290-070	111	702-2018H	353	705-2003H	351	710-2033H	353

Article No.	Page(s)	Article No.	Page(s)	Article No.	Page(s)	Article No.	Page(s)	Article No.	Page(s)	Article No.	Page(s)
710-2034H	353	715-2001H	352	720-2025H	354	730-2117H	352	760-2121H	352	785-2111H	363
710-2035H	353	715-2002H	352	720-2026H	354	730-2118H	352	761-2001H	356, 363	785-2113H	363
710-2036H	353	715-2003H	352	720-2027H	354	730-2119H	352	761-2002H	356, 363	785-2115H	363
710-2037H	353	715-2004H	352	720-2028H	354	730-2120H	352	761-2003H	356, 363	785-2117H	363
710-2038H	353	715-2005H	352	720-2029H	354	730-2121H	352	761-2004H	356, 363	785-2118H	363
710-2039H	353	715-2006H	352	720-2030H	354	732-18120	113	761-2006H	356, 363	785-2119H	363
710-2040H	353	715-2007H	352	720-2031H	354	759-2001H	356, 363	761-2007H	356, 363	785-2120H	363
710-2041H	355	715-2008H	352	720-2032H	354	759-2002H	356, 363	761-2008H	356, 363	786-2001H	363
710-2042H	355	715-2009H	352	720-2033H	354	759-2003H	356, 363	761-2011H	356, 363	786-2002H	363
710-2043H	355	715-2010H	352	720-2034H	354	759-2004H	356, 363	761-2015H	356, 363	786-2003H	363
710-2044H	355	715-2011H	352	720-2035H	354	759-2006H	356, 363	761-2016H	356, 363	786-2004H	363
710-2045H	355	715-2012H	352	720-2036H	354	759-2007H	356, 363	761-2019H	356, 363	786-2006H	363
710-2046H	355	715-2013H	352	720-2037H	354	759-2008H	356, 363	761-2023H	356, 363	786-2007H	363
710-2047H	355	715-2014H	352	720-2038H	354	759-2011H	356, 363	761-2027H	356, 363	786-2008H	363
710-2048H	355	715-2015H	352	720-2039H	354	759-2015H	356, 363	761-2031H	356, 363	786-2011H	363
710-2049H	355	715-2016H	352	720-2040H	354	759-2016H	356, 363	761-2034H	356, 363	786-2015H	363
710-2050H	355	715-2017H	354	720-2041H	355	759-2019H	356, 363	761-2036H	356, 363	786-2016H	363
710-2111H	351	715-2018H	354	720-2042H	355	759-2023H	356, 363	761-2037H	356, 363	786-2019H	363
710-2112H	351	715-2019H	354	720-2043H	355	759-2027H	356, 363	761-2040H	356, 363	786-2023H	363
710-2113H	351	715-2020H	354	720-2044H	355	759-2031H	356, 363	761-2111H	356, 363	786-2027H	363
710-2114H	351	715-2021H	354	720-2045H	355	759-2034H	356, 363	761-2113H	356, 363	786-2031H	363
710-2115H	351	715-2022H	354	720-2046H	355	759-2036H	356, 363	761-2115H	356, 363	786-2034H	363
710-2116H	351	715-2023H	354	720-2047H	355	759-2037H	356, 363	761-2117H	356, 363	786-2036H	363
710-2117H	351	715-2024H	354	720-2048H	355	759-2040H	356, 363	761-2118H	356, 363	786-2037H	363
710-2118H	351	715-2025H	354	720-2049H	355	759-2111H	356, 363	761-2119H	356, 363	786-2040H	363
710-2119H	351	715-2026H	354	720-2050H	355	759-2113H	356, 363	761-2120H	356, 363	786-2111H	363
710-2120H	351	715-2027H	354	720-2111H	352	759-2115H	356, 363	763-2003H	356	786-2113H	363
710-2121H	351	715-2028H	354	720-2112H	352	759-2117H	356, 363	763-2034H	356	786-2115H	363
711-18120	113	715-2029H	354	720-2113H	352	759-2118H	356, 363	763-2036H	356	786-2117H	363
71152-8110	113	715-2030H	354	720-2114H	352	759-2119H	356, 363	763-2037H	356	786-2118H	363
712-2001H	351	715-2031H	354	720-2115H	352	759-2120H	356, 363	763-2040H	356	786-2119H	363
712-2002H	351	715-2032H	354	720-2116H	352	75917-8110	113	763-2111H	356	786-2120H	363
712-2003H	351	715-2033H	354	720-2117H	352	75918-8110	113	763-2115H	356	78i-32020H	157
712-2004H	351	715-2034H	354	720-2118H	352	760-2001H	352	763-2118H	356	78i-32050H	157
712-2005H	351	715-2035H	354	720-2119H	352	760-2002H	352	763-2120H	356	78i-38110H	157
712-2006H	351	715-2036H	354	720-2120H	352	760-2003H	352	764-2001H	363	806-2038	371
712-2007H	351	715-2037H	354	720-2121H	352	760-2004H	352	764-2002H	363	806-2042	371
712-2008H	351	715-2038H	354	730-2001H	352	760-2005H	352	764-2003H	363	806-2111	371
712-2009H	351	715-2039H	354	730-2002H	352	760-2006H	352	764-2004H	363	806-2113	371
712-2010H	351	715-2040H	354	730-2003H	352	760-2007H	352	764-2006H	363	810-2008	370
712-2011H	351	715-2111H	352	730-2004H	352	760-2008H	352	764-2007H	363	810-2016	370
712-2012H	351	715-2112H	352	730-2005H	352	760-2009H	352	764-2008H	363	810-2023	370
712-2013H	351	715-2113H	352	730-2006H	352	760-2010H	352	764-2011H	363	810-2033	370
712-2014H	351	715-2114H	352	730-2007H	352	760-2011H	352	764-2015H	363	810-2038	370
712-2015H	351	715-2115H	352	730-2008H	352	760-2012H	352	764-2016H	363	810-2039	370
712-2016H	351	715-2116H	352	730-2009H	352	760-2013H	352	764-2019H	363	810-2040	370
712-2017H	353	715-2117H	352	730-2010H	352	760-2014H	352	764-2023H	363	810-2041	370
712-2018H	353	715-2118H	352	730-2011H	352	760-2015H	352	764-2027H	363	810-2042	370
712-2019H	353	715-2119H	352	730-2012H	352	760-2016H	352	764-2031H	363	810-2043	370
712-2020H	353	715-2120H	352	730-2013H	352	760-2017H	354	764-2034H	363	810-2111	370
712-2021H	353	715-2121H	352	730-2014H	352	760-2018H	354	764-2036H	363	810-2113	370
712-2022H	353	717i-12020H	149	730-2015H	352	760-2019H	354	764-2037H	363	811-2038	370
712-2023H	353	717i-12050H	149	730-2016H	352	760-2020H	354	764-2040H	363	811-2042	370
712-2024H	353	717i-18120H	149	730-2017H	354	760-2021H	354	764-2111H	363	811-2111	370
712-2025H	353	717i-18210H	149	730-2018H	354	760-2022H	354	764-2113H	363	811-2113	370
712-2026H	353	717i-41550HK	149	730-2019H	354	760-2023H	354	764-2115H	363	812-2008	370
712-2027H	353	717i-42550HK	149	730-2020H	354	760-2024H	354	764-2117H	363	812-2016	370
712-2028H	353	720-2001H	352	730-2021H	354	760-2025H	354	764-2118H	363	812-2023	370
712-2029H	353	720-2002H	352	730-2022H	354	760-2026H	354	764-2119H	363	812-2033	370
712-2030H	353	720-2003H	352	730-2023H	354	760-2027H	354	764-2120H	363	812-2038	370
712-2031H	353	720-2004H	352	730-2024H	354	760-2028H	354	77i-32020H	154	812-2039	370
712-2032H	353	720-2005H	352	730-2025H	354	760-2029H	354	77i-32050H	154	812-2040	370
712-2033H	353	720-2006H	352	730-2026H	354	760-2030H	354	77i-38110H	154	812-2041	370
712-2034H	353	720-2007H	352	730-2027H	354	760-2031H	354	785-2001H	363	812-2042	370
712-2035H	353	720-2008H	352	730-2028H	354	760-2032H	354	785-2002H	363	812-2043	370
712-2036H	353	720-2009H	352	730-2029H	354	760-2033H	354	785-2003H	363	812-2111	370
712-2037H	353	720-2010H	352	730-2030H	354	760-2034H	354	785-2004H	363	812-2113	370
712-2038H	353	720-2011H	352	730-2031H	354	760-2035H	354	785-2006H	363	813-2038	370
712-2039H	353	720-2012H	352	730-2032H	354	760-2036H	354	785-2007H	363	813-2042	370
712-2040H	353	720-2013H	352	730-2033H	354	760-2037H	354	785-2008H	363	813-2111	370
712-2111H	351	720-2014H	352	730-2034H	354	760-2038H	354	785-2011H	363	813-2113	370
712-2112H	351	720-2015H	352	730-2035H	354	760-2039H	354	785-2015H	363	815-2008	371
712-2113H	351	720-2016H	352	730-2036H	354	760-2040H	354	785-2016H	363	815-2016	371
712-2114H	351	720-2017H	354	730-2037H	354	760-2111H	352	785-2019H	363	815-2023	371
712-2115H	351	720-2018H	354	730-2038H	354	760-2112H	352	785-2023H	363	815-2033	371
712-2116H	351	720-2019H	354	730-2039H	354	760-2113H	352	785-2027H	363	815-2038	371
712-2117H	351	720-2020H	354	730-2040H	354	760-2115H	352	785-2031H	363	815-2039	371
712-2118H	351	720-2021H	354	730-2111H	352	760-2117H	352	785-2034H	363	815-2040	371
712-2119H	351	720-2022H	354	730-2112H	352	760-2118H	352	785-2036H	363	815-2041	371
712-2120H	351	720-2023H	354	730-2113H	352	760-2119H	352	785-2037H	363	815-2042	371
712-2121H	351	720-2024H	354	730-2115H	352	760-2120H	352	785-2040H	363	815-2043	371

Article No.	Page(s)	Article No.	Page(s)	Article No.	Page(s)	Article No.	Page(s)	Article No.	Page(s)	Article No.	Page(s)
815-2111	371	8461-38110H	377	864-2039	371	886-2008	371	902-2115H	362	905-2001H	362
815-2113	371	8461-53150	379	864-2040	371	886-2023	371	902-2116H	362	905-2002H	362
81i-32020H	157	8461-53151	379	864-2041	371	886-2038	371	902-2117H	362	905-2003H	362
81i-32025H	158	8461-53159	379	864-2042	371	886-2039	371	902-2118H	362	905-2004H	362
81i-32027H	158	8461-53320H	379	864-2043	371	886-2040	371	902-2119H	362	905-2005H	362
81i-32050H	157	8461-53321H	379	864-2111	371	886-2041	371	902-2120H	362	905-2006H	362
81i-32055H	158	8461-53322H	379	864-2113	371	886-2042	371	9020-2120H	177	905-2007H	362
81i-32057H	158	8461-53323H	379	8800-B200HK	384	886-2043	371	9020-2240H	177	905-2008H	362
81i-38110H	157	8461-61061HK	379	8800-B600HK	384	886-2111	371	9020-2250H	177	905-2009H	362
81i-38115H	158	8461-7161H	377	8800-B611HK	384	886-2113	371	9020-2270H	177	905-2010H	362
81i-38116H	158	8461-B200HK	377	8800-B670HK	384	900-54420	221	9020-2280H	177	905-2011H	362
81i-38117H	158	8462-32020H	377	8801-B200HK	384	900-54421	221	9020-2821H	177	905-2012H	362
81i-38118H	158	8462-332050HK	377	8801-B600HK	384	900-54422	221	9021-2120H	177	905-2013H	362
8450-332050HK	377	8462-34090H	377	8801-B611HK	384	900-54423	221	9021-2240H	177	905-2014H	362
8450-342550HK	377	8462-342030H	377	8801-B670HK	384	900713-342555HK	378	9021-2250H	177	905-2015H	362
8450-342557HK	378	8462-342550HK	377	8802-B200HK	384	900714-342555HK	378	9021-2270H	177	905-2016H	362
8450-B200HK	377	8462-342580HK	377	8802-B600HK	384	900719-342555HK	378	9021-2280H	177	905-2017H	364
8450-B600HK	377	8462-38110H	377	8802-B611HK	384	900725-342555HK	378	9021-2821H	177	905-2018H	364
8450-B611HK	378	8462-53150	379	8802-B670HK	384	900726-342555HK	378	9022-2120H	177	905-2019H	364
8450-B612HK	378	8462-53151	379	8803-B200HK	384	900R-1100	221	9022-2240H	177	905-2020H	364
8450-B773HK	378	8462-53159	379	8803-B600HK	384	900R-1110	221	9022-2250H	177	905-2021H	364
8450-B774HK	378	8462-53320H	379	8803-B611HK	384	900R-4035	221	9022-2270H	177	905-2022H	364
8451-332050HK	377	8462-53321H	379	8803-B670HK	384	901-37080	167	9022-2280H	177	905-2023H	364
8451-342550HK	377	8462-53322H	379	8804-B200HK	384	901-37081	167	9022-2821H	177	905-2024H	364
8451-342557HK	378	8462-53323H	379	8804-B600HK	384	901-37082	167	9023-2120H	177	905-2025H	364
8451-B200HK	377	8462-61061HK	379	8804-B611HK	384	901i-27180H	166	9023-2240H	177	905-2026H	364
8451-B600HK	377	8462-7161H	377	8804-B670HK	384	901i-27181H	166	9023-2250H	177	905-2027H	364
8451-B611HK	378	8462-B200HK	377	8810-342030H	384	901i-27182H	166	9023-2270H	177	905-2028H	364
8451-B612HK	378	8463-32020H	377	8810-7161H	384	901i-32020H	164	9023-2280H	177	905-2029H	364
8451-B773HK	378	8463-332050HK	377	8810-B200HK	384	901i-32050H	164	9023-2821H	177	905-2030H	364
8451-B774HK	378	8463-34090H	377	8810-B600HK	384	901i-32080H	165	9024-2120H	177	905-2031H	364
8452-332050HK	377	8463-342030H	377	8811-342030H	384	901i-32100H	165	9024-2240H	177	905-2032H	364
8452-342550HK	377	8463-342550HK	377	8811-7161H	384	901i-34020H	167	9024-2250H	177	905-2033H	364
8452-342557HK	378	8463-342580HK	377	8811-B200HK	384	901i-34090H	165	9024-2270H	177	905-2034H	364
8452-B200HK	377	8463-38110H	377	8811-B600HK	384	901i-38110H	164	9024-2280H	177	905-2035H	364
8452-B600HK	377	8463-53150	379	8812-342030H	384	901i-42550HK	164	9024-2821H	177	905-2036H	364
8452-B611HK	378	8463-53151	379	8812-7161H	384	901i-42580HK	165	9025-2120H	177	905-2037H	364
8452-B612HK	378	8463-53159	379	8812-B200HK	384	902-2001H	362	9025-2240H	177	905-2038H	364
8452-B773HK	378	8463-53320H	379	8812-B600HK	384	902-2002H	362	9025-2250H	177	905-2039H	364
8452-B774HK	378	8463-53321H	379	8813-342030H	384	902-2003H	362	9025-2270H	177	905-2040H	364
8453-332050HK	377	8463-53322H	379	8813-7161H	384	902-2004H	362	9025-2280H	177	905-2111H	362
8453-342550HK	377	8463-53323H	379	8813-B200HK	384	902-2005H	362	9025-2821H	177	905-2112H	362
8453-342557HK	378	8463-7161H	377	8813-B600HK	384	902-2006H	362	9026-2120H	177	905-2113H	362
8453-B200HK	377	8463-B200HK	377	8814-342030H	384	902-2007H	362	9026-2240H	177	905-2114H	362
8453-B600HK	377	8464-32020H	377	8814-7161H	384	902-2008H	362	9026-2250H	177	905-2115H	362
8453-B611HK	378	8464-332050HK	377	8814-B200HK	384	902-2009H	362	9026-2270H	177	905-2116H	362
8453-B612HK	378	8464-34090H	377	8814-B600HK	384	902-2010H	362	9026-2280H	177	905-2117H	362
8453-B773HK	378	8464-342030H	377	8823-B700HK	471	902-2011H	362	9026-2821H	177	905-2118H	362
8453-B774HK	378	8464-342550HK	377	8823-B710HK	471	902-2012H	362	9027-2120H	177	905-2119H	362
8454-332050HK	377	8464-342580HK	377	8823-B729HK	471	902-2013H	362	9027-2240H	177	905-2120H	362
8454-342550HK	377	8464-38110H	377	8823-B770HK	471	902-2014H	362	9027-2250H	177	910-2001H	362
8454-342557HK	378	8464-53150	379	8824-B700HK	471	902-2015H	362	9027-2270H	177	910-2002H	362
8454-B200HK	377	8464-53151	379	8824-B710HK	471	902-2016H	362	9027-2280H	177	910-2003H	362
8454-B600HK	377	8464-53159	379	8824-B729HK	471	902-2017H	364	9027-2821H	177	910-2004H	362
8454-B611HK	378	8464-53320H	379	8824-B770HK	471	902-2018H	364	902R-1100	221	910-2005H	362
8454-B612HK	378	8464-53321H	379	8825-B700HK	471	902-2019H	364	902R-1110	221	910-2006H	362
8454-B773HK	378	8464-53322H	379	8825-B710HK	471	902-2020H	364	902R-4035	221	910-2007H	362
8454-B774HK	378	8464-53323H	379	8825-B729HK	471	902-2021H	364	9030-2120H	177	910-2008H	362
8460-32020H	377	8464-7161H	377	8825-B770HK	471	902-2022H	364	9030-2240H	177	910-2009H	362
8460-332050HK	377	8464-B200HK	377	8826-B700HK	471	902-2023H	364	9030-2250H	177	910-2010H	362
8460-34090H	377	8471-B610HK	314	8826-B710HK	471	902-2024H	364	9030-2270H	177	910-2011H	362
8460-342030H	377	8471-B620HK	314	8826-B729HK	471	902-2025H	364	9030-2280H	177	910-2012H	362
8460-342550HK	377	8471-B629HK	314	8826-B770HK	471	902-2026H	364	9030-2821H	177	910-2013H	362
8460-342580HK	377	8471-B660HK	314	8827-B700HK	471	902-2027H	364	9031-2120H	177	910-2014H	362
8460-38110H	377	8471-B670HK	314	8827-B710HK	471	902-2028H	364	9031-2240H	177	910-2015H	362
8460-53150	379	8471-B690HK	314	8827-B729HK	471	902-2029H	364	9031-2250H	177	910-2016H	362
8460-53151	379	8471-B695HK	314	8827-B770HK	471	902-2030H	364	9031-2270H	177	910-2017H	364
8460-53159	379	8471-B698HK	314	8828-B700HK	471	902-2031H	364	9031-2280H	177	910-2018H	364
8460-53320H	379	8472-B610HK	314	8828-B710HK	471	902-2032H	364	9031-2821H	177	910-2019H	364
8460-53321H	379	8472-B620HK	314	8828-B729HK	471	902-2033H	364	9032-2120H	177	910-2020H	364
8460-53322H	379	8472-B629HK	314	8828-B770HK	471	902-2034H	364	9032-2240H	177	910-2021H	364
8460-53323H	379	8472-B660HK	314	885-2008	371	902-2035H	364	9032-2250H	177	910-2022H	364
8460-61061HK	379	8472-B670HK	314	885-2023	371	902-2036H	364	9032-2270H	177	910-2023H	364
8460-7161H	377	8472-B690HK	314	885-2038	371	902-2037H	364	9032-2280H	177	910-2024H	364
8460-B200HK	377	8472-B695HK	314	885-2039	371	902-2038H	364	9032-2821H	177	910-2025H	364
8461-32020H	377	8472-B698HK	314	885-2040	371	902-2039H	364	9033-2120H	177	910-2026H	364
8461-332050HK	377	864-2008	371	885-2041	371	902-2040H	364	9033-2240H	177	910-2027H	364
8461-34090H	377	864-2016	371	885-2042	371	902-2111H	362	9033-2250H	177	910-2028H	364
8461-342030H	377	864-2023	371	885-2043	371	902-2112H	362	9033-2270H	177	910-2029H	364
8461-342550HK	377	864-2033	371	885-2111	371	902-2113H	362	9033-2280H	177	910-2030H	364
8461-342580HK	377	864-2038	371	885-2113	371	902-2114H	362	9033-2821H	177	910-2031H	364

Article No.	Page(s)	Article No.	Page(s)
910-2032H	364	920-2036H	364
910-2033H	364	920-2037H	364
910-2034H	364	920-2038H	364
910-2035H	364	920-2039H	364
910-2036H	364	920-2040H	364
910-2037H	364	920-2111H	362
910-2038H	364	920-2112H	362
910-2039H	364	920-2113H	362
910-2040H	364	920-2114H	362
910-2111H	362	920-2115H	362
910-2112H	362	920-2116H	362
910-2113H	362	920-2117H	362
910-2114H	362	920-2118H	362
910-2115H	362	920-2119H	362
910-2116H	362	920-2120H	362
910-2117H	362	926-37080	167
910-2118H	362	926-37081	167
910-2119H	362	926-37082	167
910-2120H	362	926i-27180H	166
918-37080	167	926i-27181H	166
918-37081	167	926i-27182H	166
918-37082	167	926i-32020H	164
918i-27180H	166	926i-32050H	164
918i-27181H	166	926i-32080H	165
918i-27182H	166	926i-32100H	165
918i-32020H	164	926i-34020H	167
918i-32050H	164	926i-34090H	165
918i-32080H	165	926i-38110H	164
918i-32100H	165	926i-42550HK	164
918i-34020H	167	926i-42580HK	165
918i-34090H	165	929R-1100	221
918i-34306H	167	929R-1110	221
918i-38110H	164	929R-4035	221
918i-42550HK	164	948D-1010	291
918i-42580HK	165	948D-1630	291
91i-32020H	153	950D-1010	291
91i-32025H	155	950D-1630	291
91i-32027H	155	980-2003H	362
91i-32050H	153	980-2007H	362
91i-32055H	155	980-2011H	362
91i-32057H	155	980-2015H	362
91i-38110H	153	980-2019H	364
91i-38115H	155	980-2023H	364
91i-38116H	155	980-2027H	364
91i-38117H	155	980-2031H	364
91i-38118H	155	980-2039H	364
920-2001H	362	980-2111H	362
920-2002H	362	980-2118H	362
920-2003H	362	980-2120H	362
920-2004H	362		
920-2005H	362		
920-2006H	362		
920-2007H	362		
920-2008H	362		
920-2009H	362		
920-2010H	362		
920-2011H	362		
920-2012H	362		
920-2013H	362		
920-2014H	362		
920-2015H	362		
920-2016H	362		
920-2017H	364		
920-2018H	364		
920-2019H	364		
920-2020H	364		
920-2021H	364		
920-2022H	364		
920-2023H	364		
920-2024H	364		
920-2025H	364		
920-2026H	364		
920-2027H	364		
920-2028H	364		
920-2029H	364		
920-2030H	364		
920-2031H	364		
920-2032H	364		
920-2033H	364		
920-2034H	364		
920-2035H	364		

Model	Series	Page(s)	Model	Series	Page(s)	Model	Series	Page(s)
ø 1 cm / 3/8 Inch			7 x 30 cm / 2 13/16 x 12 Inch					
Loop		256	Area Pro.		50	Strata		456
1 x 20 cm / 3/8 x 8 Inch			Basis 3		111	Unique		482
Basis 1		107	7 x 60 cm / 2 13/16 x 24 Inch			Valley		488
2.5 x 2.5 cm / 1 x 1 Inch			Alcina		38	10 x 90 cm / 4 x 36 Inch		
Amano		46	Area Pro.		50	Cedra		132
Fresh		222	Aruba		78	12.5 x 12.5 cm / 5 x 5 Inch		
Karl		236	Basis Pro		114	Ascona		86
Marble & More		284	Cedra		132	Chroma		140
Ocean		316	Emotion		190	Chroma non-slip		150
Pattern		322	Evalia		202	Chroma unglazed		160
Plural non-slip		358	Factory		208	Quarzit		372
Plural unglazed		366	Like		246	12.5 x 25 cm / 5 x 10 Inch		
Senja Pure		386	Lounge		264	Area Pro.		50
ø 2 cm / 6/8 Inch			Nova		302	Ascona		86
Loop		256	Sento		392	Chroma		140
4 x 60 cm / 1 5/8 x 24 Inch			Sierra		400	Chroma non-slip		150
Area Pro.		50	Skill		406	Chroma unglazed		160
Mandalay		274	Solid Ground		412	Craft		172
Strata		456	Solid Rock		424	Ferrum		218
4.5 x 20 cm / 1 13/16 x 8 Inch			Stone Duo		438	Natural Ceramics		288
Basis 1		107	Stories		446	Ocean		316
5 x 5 cm / 2 x 2 Inch			Strata		456	Quarzit		372
Alcina		38	Trio		472	12.5 x 50 cm / 5 x 20 Inch		
Area Pro.		50	Unique		482	Chroma		140
Ascona		86	Valley		488	Plural		338
Basic Stone		100	7.2 x 60 cm / 2 7/8 x 24 Inch			12.5 x 100 cm / 5 x 40 Inch		
Basis 2		110	Area Pro.		50	Plural		338
Basis 3		111	Strata		456	15 x 15 cm / 6 x 6 Inch		
Basis Pro		114	7.2 x 120 cm / 2 7/8 x 48 Inch			Area Pro.		50
Cedra		132	Area Pro.		50	Ascona		86
Evalia		202	Strata		456	Basis 1		107
Factory		208	7.2 x 145 cm / 2 7/8 x 58 Inch			Basis 2		110
Fresh		222	Area Pro.		50	Basis 3		111
Like		246	Strata		456	Basis Pro		114
Lounge		264	7.5 x 25 cm / 3 1/8 x 10 Inch			Emotion		190
Nova		302	Aruba		78	Nova		302
Pattern		322	7.9 x 25 cm / 3 1/8 x 10 Inch			Pattern		322
Plural		338	Chroma unglazed		160	Plural		338
Plural non-slip		358	8 x 60 cm / 3 3/16 x 24 Inch			Plural unglazed		366
Plural unglazed		366	Concrete		168	Quarzit		372
Quarzit		372	8.45 x 33 cm / 3 13/32 x 13 13/64 Inch			Savona		380
Savona		380	Mando		278	Trio		472
Senja Pure		386	10 x 10 cm / 4 x 4 Inch			15 x 30 cm / 6 x 12 Inch		
Sento		392	Area Pro.		50	Basis 1		107
Sierra		400	Basis 2		110	Plural		338
Solid Rock		424	Basis 3		111	15 x 60 cm / 6 x 24 Inch		
Stone Duo		438	Emotion Grip		196	Area Pro.		50
Stories		446	Karl		236	Basis Pro		114
Strata		456	Pattern		322	Emotion		190
Trio		472	Plural		338	Nova		302
Unique		482	Plural non-slip		358	Pizarro		334
Valley		488	Plural unglazed		366	Solid Ground		412
5 x 10 cm / 2 x 4 Inch			Strata		456	Solid Rock		424
District		182	10 x 15 cm / 4 x 6 Inch			Strata		456
5 x 15 cm / 2 x 6 Inch			Basis 3		111	Unique		482
Solid Ground		412	10 x 20 cm / 4 x 8 Inch			Valley		488
5 x 60 cm / 2 x 24 Inch			Area Pro.		50	15 x 90 cm / 6 x 36 Inch		
Solid Ground		412	Basis 3		111	Oak		310
Solid Rock		424	Emotion Grip		196	15.4 x 15.4 cm / 6 3/16 x 6 3/16 Inch		
Unique		482	Plural		338	Orientation Aids for the Blind		122
Valley		488	10 x 25 cm / 4 x 10 Inch			20 x 20 cm / 8 x 8 Inch		
6 x 50 cm / 2 3/8 x 20 Inch			Ascona		86	Area Pro.		50
Ascona		86	District		182	Basis 1		107
Quarzit		372	Karl		236	Basis 2		110
6 x 60 cm / 2 3/8 x 24 Inch			10 x 30 cm / 4 x 12 Inch			Basis 3		111
Ascona		86	Area Pro.		50	Emotion Grip		196
Oak		310	Basis Pro		114	Pattern		322
Quarzit		372	Emotion Grip		196	Plural		338
Savona		380	Strata		456	Plural non-slip		358
Streetlife Metallic		468	10 x 50 cm / 4 x 20 Inch			Plural unglazed		366
Walden		494	Ascona		86	20 x 25 cm / 8 x 10 Inch		
6.2 x 25 cm / 2 1/2 x 10 Inch			10 x 60 cm / 4 x 24 Inch			Basis 1		107
Chroma		140	Area Pro.		50	20 x 40 cm / 8 x 16 Inch		
Chroma unglazed		160	Ascona		86	Basis 1		107
Craft		172	Basis Pro		114	Plural		338
Ocean		316	Cedra		132	20 x 60 cm / 8 x 24 Inch		
6.2 x 50 cm / 2 1/2 x 20 Inch			Nova		302	Valley		488
Craft extended		178	Quarzit		372	20 x 120 cm / 8 x 48 Inch		
7 x 20 cm / 2 13/16 x 8 Inch			Solid Rock		424	Walden		494
Basis 3		111				24.3 x 43.8 cm / 10 x 18 Inch		
						Alcina		38

512 Index according to models





Model	Series	Page(s)
25 x 8.9 cm / 10 x 3 1/2 Inch		
	Eladuct + KerAion Ela 10 .6	186
25 x 12.5 cm / 10 x 5 Inch		
	Basis 4	113
	Eladuct + KerAion Ela 10 .6	186
	Ferrum	218
25 x 15.6 cm / 10 x 6 1/4 Inch		
	Ferrum	218
25 x 25 cm / 10 x 10 Inch		
	Area Pro	50
	Ascona	86
	Chroma	140
	Chroma non-slip	150
	Chroma unglazed	160
	Natural Ceramics	288
	Quarzit	372
25 x 33 cm / 10 x 13 Inch		
	Basis 1	107
25 x 50 cm / 10 x 20 Inch		
	Area Pro	50
	Ascona	86
	Chroma	140
	Chroma unglazed	160
	Plural	338
	Quarzit	372
27.8 x 20 cm / 11 x 8 Inch		
	Emotion Grip	196
28 x 145 cm / 11 3/16 x 58		
	Area Pro	50
	Ascona	86
	Nova	302
	Quarzit	372
	Solid Ground	412
	Strata	456
30 x 8.7 cm / 12 x 3 1/2 Inch		
	Eladuct + KerAion Ela 10.6	186
30 x 30 cm / 12 x 12 Inch		
	Area Pro	50
	Basis 3	111
	Basis Pro	114
	Orientation Aids for the Blind	122
	Emotion	190
	Emotion Grip	196
	New Market	292
	Plural	338
	Sento	392
	Sierra	400
	Stone Duo	438
	Stories	446
	Strata	456
	Unique	482
	Valley	488
30 x 35 cm / 12 x 14 Inch		
	Oak	310
30 x 44.5 cm / 12 x 18 Inch		
	Like	246
30 x 60 cm / 12 x 24 Inch		
	Alcina	38
	Area Pro	50
	Aruba	78
	Ascona	86
	Basis 1	107
	Basis 1+	109
	Basis 2	110
	Basis 3	111
	Basis Pro	114

Model	Series	Page(s)
	Cedra	132
	Concrete	168
	Emotion	190
	Evalia	202
	Factory	208
	Like	246
	Lounge	264
	Mandalay	274
	New Market	292
	Nivella	300
	Nova	302
	Pizarro	334
	Plural	338
	Plural non-slip	358
	Plural unglazed	366
	Quarzit	372
	Savona	380
	Senja Pure	386
	Sento	392
	Sierra	400
	Skill	406
	Solid Ground	412
	Solid Rock	424
	Stone Concept	432
	Stone Duo	438
	Stories	446
	Strata	456
	Trio	472
	Unique	482
	Valley	488
30 x 90 cm / 12 x 36 Inch		
	Alcina	38
	Area Pro	50
	Aruba	78
	Basis 1	107
	Basis 1+	109
	Cedra	132
	Evalia	202
	Factory	208
	Lounge	264
	Oak	310
	Senja Pure	386
	Trio	472
30 x 120 cm / 12 x 48 Inch		
	Factory	208
	Oak	310
	Skill	406
	Streetlife Metallic	468
	Trio	472
31 x 30 cm / 12 13/64 x 12 Inch		
	Craft extended	178
31 x 145 cm / 12 3/8 x 58 Inch		
	Area Pro	50
	Ascona	86
	Nova	302
	Quarzit	372
	Solid Ground	412
	Strata	456
35 x 100 cm / 14 x 40 Inch		
	Basis 1	107
	Bliss	128
	Mando	278
	Sento	392
	Stories	446
40 x 120 cm / 16 x 48 Inch		
	Oak	310

Model	Series	Page(s)
50 x 25 cm / 20 x 10 Inch		
	Area Pro	50
	Ascona	86
	Quarzit	372
50 x 100 cm / 20 x 40 Inch		
	Ascona	86
	Plural	338
60 x 60 cm / 24 x 24 Inch		
	Alcina	38
	Area Pro	50
	Aruba	78
	Ascona	86
	Basis Pro	114
	Eladuct + KerAion Ela 10 .6	186
	Emotion	190
	Evalia	202
	Factory	208
	KerAion OP Special Glazes	242
	Like	246
	Lounge	264
	New Market	292
	Nova	302
	Quarzit	372
	Savona	380
	Sento	392
	Skill	406
	Solid Ground	412
	Solid Rock	424
	Stone Duo	438
	Stories	446
	Strata	456
	Streetlife Metallic	468
	Trio	472
	Unique	482
	Valley	488
60 x 120 cm / 24 x 48 Inch		
	Area Pro	50
	Aruba	78
	Factory	208
	Lounge	264
	Nova	302
	Oak	310
	Savona	380
	Sento	392
	Skill	406
	Solid Ground	412
	Solid Rock	424
	Stone Duo	438
	Strata	456
	Streetlife Metallic	468
	Trio	472
	Unique	482
	Valley	488
80 x 80 cm / 32 x 32 Inch		
	Like	246
90 x 90 cm / 36 x 36 Inch		
	Area Pro	50
100 x 100 cm / 40 x 40 Inch		
	Stories	446
120 x 120 cm / 48 x 48 Inch		
	Like	246
	Lounge	264
	Solid Ground	412
	Trio	472

Model No.	Page(s)	Model No.	Page(s)	Model No.	Page(s)	Model No.	Page(s)
1010	291	2821	177	37080	167	54422	221
1100	221	32020H	153, 154, 157, 164, 377	37081	167	54423	221
1110	189, 221	32025H	155, 158	37082	167	61061HK	379
12020H	146, 148, 149	32027H	155, 158	38110	113	6635	127
12023H	147	32050H	153, 154, 157, 164	38110H	153, 154, 157, 164, 377	6636	127
12050H	146, 148, 149	32055H	155, 158	38115H	155, 158	703	351, 353
12053H	147	32057H	155, 158	38116H	155, 158	7161H	377, 384
1630	291	32080H	165	38117H	155, 158	730	352, 354
18120	113	32100H	165	38118H	155, 158	760	352, 354
18120H	146, 148, 149	332050HK	377	4000	189	8110	113
18123H	147	34020H	167	4003	189	9215	181
18124H	147	34090H	165, 377	4004	189	B200HK	377, 384
18210H	146, 148, 149	341550HK	351, 353	4035	221	B600HK	245, 377, 384
18213H	147	342030H	377, 384	41550HK	146, 148, 149	B611HK	378, 384
18214H	147	342550HK	352, 354, 377	42550HK	146, 148, 149, 164	B612HK	378
2120	177	342555HK	378	42580HK	165	B670HK	384
2240	177	342557HK	378	53150	379	B700HK	471
2250	177	342580HK	377	53151	379	B710HK	471
2270	177	34306H	167	53159	379	B729HK	471
2280	177	352010HK	351, 353	53320	379	B770HK	471
2290	181	352050HK	352, 354	53321	379	B773HK	378
2320	181	37040	189	53322	379	B774HK	378
27180H	166	37042	189	53323	379	K100	189
27181H	166	37043	189	54420	221		
27182H	166	37044	189	54421	221		

Agrob Buchtal offers tiles with overglazed edges in many series. In the case of **split tiles**, overglazed or overglazed rounded edges are available upon request according to the following model number system:

					
Last figure 0 of model no.	...1 = Short edge	...2 = Longitudinal edge	...3 = Corner left	...4 = Corner right	overglazed edges
to be replaced by5 = Short edge	...6 = Longitudinal edge	...7 = Corner left	...8 = Corner right	overglazed rounded edges (bullnoses)

**Example: Standard model no. 18120 = 244 x 119 x 6 mm,
model no. 18123 = overglazed corner left**

Area Pro

Color	similar to NCS no.	similar to RAL no.	Color Shade Variation
anthracite	S7502-B	7024	V2
basalt	S7005-B80G	180 4005	V2
pebble	S3502-Y	7030	V2
stone	S2502-Y	100 7005	V2
sand-white	S1502-Y50R	080 8005	V2
sand-grey	S1502-Y50R	080 7005	V2
sand	S5005-Y20R	075 5010	V2
nutmeg	S7005-Y50R	060 4005	V2
platinum	S0500-N	8500	V2
sand-beige	S1005-Y50R	060 8010	V2
brick	S7010-Y30R	060 4010	V2
clay	S8010-Y50R	050 3010	V2

Chroma und Plural

Color	similar to NCS no.	similar to RAL no.	Lightness Value Y
neutral 1 (Chroma unglazed)	S9000-N	9017	3
neutral 1	8000	7016	6
neutral 2	S7500-N	7015	9
neutral 3	S6500-N		15
neutral 4	S6000-N	7037	18
neutral 5	S5502-B	7046	21
neutral 6	S4502-B	7045	25
neutral 7	S4000-N	7004	33
neutral 8	S2502-B		46
neutral 9	S1502-R50B		65
neutral 10 (Chroma, Plural)	S1000-N	9003	76
neutral 10 (Chroma unglazed)	0502-Y	9001	66
neutral 10 (white glossy)	S1500	9003	70
active azure	S5030-R80B	5000	9
light azure	S2030-R80B		37
medium azure	S4030-R90B		21
dark azure	S4040-R90B	5007	13
active blue	S6030-R90B		7
light blue	S1510-R80B		60
medium blue	S2020-R80B		40
dark blue	S4030-R80B		17
active turquoise	S4030-B50G	6033	22
light turquoise	S1010-B50G		63
medium turquoise	S2020-B30G		44
dark turquoise	S4020-B30G		26
active green	S3050-G50Y		26
light green	S0510-G		69
medium green	S1515-G20Y	6019	53
dark green	S3020-G10Y	6021	31
active yellow	S3050-Y10R		32
light yellow	S1010-Y10R	1015	69
medium yellow	S2030-Y10R		50
dark yellow	S2050-Y20R		33
active ochre	S3050-Y40R		20
light ochre	S2030-Y20R		48
medium ochre	S3030-Y30R		36
dark ochre	S4030-Y50R		21
active salmon	S4040-Y70R		15
light salmon	S1515-Y50R		51
medium salmon	S2020-Y50R		39
dark salmon	S3040-Y60R		23
active oxide red	S4050-Y90R		10
light oxide red	S2010-Y80R		46
medium oxide red	S3020-Y80R		25
dark oxide red	S5020-Y80R		15
active stone grey	S5030-Y90R		9
light stone grey	S2502-R		46
medium stone grey	S3502-R	7036	34
dark stone grey	S6005-Y80R		15
active sand grey	S7010-Y90R		8
light sand grey	S1502-Y		56
medium sand grey	S3005-Y50R		35
dark sand grey	S6010-Y50R		14

Special colors

Color	similar to NCS no.	similar to RAL no.	Lightness Value Y
apple-green	S1060-G40Y		39
medium brown	S5020-Y50R	060 50 20	17
grey	S3502-Y	100 70 05	32
intense blue	6040-R70B		1
contrasting red (Chroma non-slip B)	S2050-Y90R	3017	14
contrasting red (Chroma non-slip C)	S2060-Y90R	3018	15
contrasting red (Chroma)	S2570-Y90R	3002	10
natural white	2005-Y20R	7032	51
orange	S2060-Y50R	2010	24
medium sand-beige	S1010-Y20R	1001	44
violet	S5020-R50B	4001	13
lemon-yellow	1070-Y	1016	52

Intense colors

Color	similar to NCS no.	similar to RAL no.	Lightness Value Y
violet	S3555-R60B	300 30 25	11
berry red	S4050-R20B	360 30 35	11
brown red	S2570-Y90R	3003	10
fire red	S1080-R	3002	14
signal orange	S1070-Y30R	060 70 70	39
sunshine yellow	S1070-Y	080 70 70	50
yellow green	S2050-G40Y	120 60 50	34
sea green	S4030-G	6000	21
blue green	S3040-B50G	190 50 25	23
cobalt blue	S4055-R70B	290 30 40	8

KerAion Special Glazes for Operation Theatres

Color	similar to NCS no.	similar to RAL no.	Lightness Value Y
beige	0502-Y	1013	69
blue	0530-R90B		46
grey	3000-N	7038	47
green	2030-B70G	6027	36
light-grey	1502-G50Y	7047	58
white	0500-N	9003	78

The use of color as an architectural design means has gained increasing importance during the last years. Therefore, we provide you with a list of the relevant Agrob Buchtal design series in order to facilitate planning. It classifies the colors according to:

NCS = Natural Color System

(More detailed information can be obtained from: Scandinavian Color Institute AB, P.O. Box 49022 · S-10028 Stockholm · Phone +46/8/6174700 · Fax +46/8/6174747, Institut für Farbe – Brigitte Hartmann · Rotes Knie 6 · 74389 Cleebrohn Phone 07135/12742 · Fax 07135/12737)

RAL Color Chart

(More detailed information can be obtained from: RAL – Deutsches Institut für Gütesicherung und Kennzeichnung e.V. · Siegburger Straße 39 · D-53757 St. Augustin Phone +49 (0) 2241/1605-0 · Fax +49 (0) 2241/1605-11)

Lightness Value:

This figure (standard color value Y) describes the lightness of a color in comparison with an ideally white surface if illuminated under identical light conditions, i. e. same intensity, direction and quality. For an ideal white, which means that all the incident light is reflected, the value Y = 100 applies (black: Y = 0).

Please note that these classifications may only serve as an orientation aid. Original samples will be made available to you upon request.

The difference in lightness of two adjoining colored surfaces is called luminance contrast. By means of this value, one can determine whether a room design is rich in contrast, as it is required, for example, by DIN 32975 "Designing visual information in the public area for accessible use". In the following, you will find the relevant values for selected series. They result from the

respective lightness values, which are indicated as averaged values of individual measurements. We will be pleased to determine values for other products upon request.

Luminance contrast Series Area Pro										
		anthracite	basalt	pebble	stone	sand-white	sand-grey	sand	nutmeg	
<i>Lightness Value Y</i>		8	13	21	33	50	38	21	14	
anthracite	8	0.00	0.23	0.44	0.60	0.72	0.64	0.44	0.24	
basalt	13		0.00	0.23	0.43	0.59	0.49	0.24	0.01	
pebble	21			0.00	0.22	0.41	0.29	0.01	0.22	
stone	33				0.00	0.21	0.08	0.21	0.42	
sand-white	50					0.00	0.14	0.40	0.58	
sand-grey	38						0.00	0.28	0.48	
sand	21							0.00	0.23	
nutmeg	14								0.00	
platinum	58									
sand-beige	41									
brick	14									
clay	10									

Luminance contrast Series Ascona							
		shell	sand	pearl	stone	mud	graphite
<i>Lightness Value Y</i>		55	50	47	40	27	11
shell	55	0.00					
sand	50	0.05	0.00				
pearl	47	0.08	0.03	0.00			
stone	40	0.16	0.11	0.08	0.00		
mud	27	0.34	0.30	0.27	0.19	0.00	
graphite	11	0.67	0.64	0.62	0.57	0.42	0.00

Luminance contrast Series Basis Pro						
		anthracite	basalt	ash-brown	concrete-grey	sand-beige
<i>Lightness Value Y</i>		7	10	20	24	42
anthracite	7	0.00				
basalt	10	0.14	0.00			
ash-brown	20	0.42	0.26	0.00		
concrete-grey	24	0.49	0.33	0.07	0.00	
sand-beige	42	0.66	0.53	0.29	0.22	0.00

Luminance contrast Series Area Pro (continuation)

		platinum	sand-beige	brick	clay
<i>Lightness Value Y</i>		58	41	14	10
anthracite	8	0.75	0.66	0.25	0.07
basalt	13	0.63	0.51	0.03	0.16
pebble	21	0.47	0.32	0.21	0.38
stone	33	0.28	0.11	0.41	0.55
sand-white	50	0.07	0.11	0.57	0.68
sand-grey	38	0.21	0.04	0.47	0.60
sand	21	0.46	0.31	0.21	0.38
nutmeg	14	0.62	0.50	0.01	0.17
platinum	58	0.00	0.18	0.62	0.72
sand-beige	41		0.00	0.49	0.62
brick	14			0.00	0.19
clay	10				0.00

Luminance contrast Series Emotion (Floor)

		deep anthracite	basalt	mid-grey	light-beige
<i>Lightness Value Y</i>		7	19	32	46
deep anthracite	7	0.00			
basalt	19	0.46	0.00		
mid-grey	32	0.64	0.25	0.00	
light-beige	46	0.74	0.42	0.18	0.00

Luminance contrast Series Factory

		blue steel	asphalt	bronze grey	aluminium	lime
<i>Lightness Value Y</i>		13	14	16	33.5	51.5
blue steel	13	0.00				
asphalt	14	0.04	0.00			
bronze grey	16	0.10	0.07	0.00		
aluminium	33.5	0.44	0.41	0.35	0.00	
lime	51.5	0.60	0.57	0.53	0.21	0.00

Luminance contrast Series Nova									
		cream-beige	mid-brown	mid-grey	basalt	anthracite	creme-beige-multicolored	mid-grey-multicolored	anthracite-multicolored
<i>Lightness Value Y</i>		44	18	35	15	6	44	35	9
cream-beige	44	0.00	0.42	0.11	0.49	0.76	0.00	0.11	0.66
mid-brown	18		0.00	0.32	0.09	0.50	0.42	0.32	0.33
mid-grey	35			0.00	0.40	0.71	0.11	0.00	0.59
basalt	15				0.00	0.43	0.49	0.40	0.25
anthracite	6					0.00	0.76	0.71	0.20
creme-beige-multicolored	44						0.00	0.11	0.66
mid-grey-multicolored	35							0.00	0.59
anthracite-multicolored	9								0.00

Luminance contrast Series Quarzit						
		basalt-grey	quarz-grey	sand-beige	sepia-brown	white grey
<i>Lightness Value Y</i>		15	40	47	30	55
basalt-grey	15	0.00				
quarz-grey	40	0.45	0.00		0.14	
sand-beige	47	0.52	0.08	0.00	0.22	
sepia-brown	30	0.33			0.00	
white grey	55	0.57	0.16	0.08	0.29	0.00

Luminance contrast Series Savona						
		lime	beige	brown	grey	anthracite
<i>Lightness Value Y</i>		52	38	20	20	8
lime	52	0.00	0.16	0.44	0.44	0.73
beige	38		0.00	0.31	0.31	0.65
brown	20			0.00	0.00	0.43
grey	20			0.00	0.00	0.43
anthracite	8					0.00

Luminance contrast Series Strata									
		lava	volcano	stone	loam	clay	quarz	lime	pumice
<i>Lightness Value Y</i>		7.4	8.5	12.9	19.2	26.0	32.0	37.0	48.6
pumice	48.6	0.74	0.70	0.58	0.43	0.30	0.21	0.14	0.00
lime	37.0	0.67	0.63	0.48	0.32	0.17	0.07	0.00	
quarz	32.0	0.62	0.58	0.43	0.25	0.10	0.00		
clay	26.0	0.56	0.51	0.34	0.15	0.00			
loam	19.2	0.44	0.39	0.20	0.00				
stone	12.9	0.27	0.21	0.00					
volcano	8.5	0.07	0.00						
lava	7.4	0.00							

Luminance contrast Series Trio						
		slate black	mud grey	iron grey	cement grey	ivory white
<i>Lightness Value Y</i>		9.9	18.8	19.3	35.1	52.5
slate black	9.9	0.00				
mud grey	18.8	0.31	0.00			
iron grey	19.3	0.32	0.01	0.00		
cement grey	35.1	0.56	0.30	0.29	0.00	
ivory white	52.5	0.68	0.47	0.46	0.20	0.00

Luminance contrast Series Trio Terrazzo				
		terrazzo black	terrazzo red	terrazzo ivory
<i>Lightness Value Y</i>		13	19.1	43.5
terrazzo black	13	0.00		
terrazzo red	19.1	0.19	0.00	
terrazzo ivory	43.5	0.54	0.39	0.00

Luminance contrast Series Unique							
		anthracite	basalt	light-grey	beige	brown	mud
<i>Lightness Value Y</i>		6	17	36	45	18	30
anthracite	6	0.00					
basalt	17	0.48	0.00				
light-grey	36	0.71	0.36	0.00		0.33	0.09
beige	45	0.76	0.45	0.11	0.00	0.43	0.20
brown	18	0.50	0.03			0.00	
mud	30	0.67	0.28			0.25	0.00

Luminance contrast Series Valley					
		slate	pebble-grey	earth-brown	sand-beige
<i>Lightness Value Y</i>		9	33	10	51
slate	9	0.00			
pebble-grey	33	0.57	0.00	0.53	
earth-brown	10	0.05		0.00	
sand-beige	51	0.70	0.21	0.67	0.00



European Quality Standards

Product Standards <small>(simplified and based on 20 x 20 cm (BIII), or 30 x 30 cm (BI))</small>	Extruded Ceramic Tiles DIN EN 14411		Dry-pressed Ceramic Tiles DIN EN 14411		Test Standards
	group A _{Ia} + A _{Ib} „Nature“ „Precision“	group A _{IIa} - part 1 „Nature“ „Precision“	group B _{Ia} + B _{Ib}	group BIII	
A) Dimensions + Surfaces					
1. Length and Width	± 2 % ± 1.0%	± 2 % ± 1.25 %	± 0.6%	± 0.5%	DIN EN ISO 10545-2
2. Thickness	± 10 % ± 10 %	± 10 % ± 10 %	± 5 %	± 10 %	DIN EN ISO 10545-2
3. Straightness of Edges	± 0.6% ± 0.5%	± 0.6% ± 0.5%	± 0.5%	± 0.3%	DIN EN ISO 10545-2
4. Rectangularity	± 1.0% ± 1.0%	± 1.0% ± 1.0%	± 0.5%	± 0.5%	DIN EN ISO 10545-2
5. Surface Flatness					DIN EN ISO 10545-2
5.1 Curvature at Centre	± 1.5% ± 0.5%	± 1.5% ± 0.5%	± 0.5%	+ 0.5/-0.3%	DIN EN ISO 10545-2
5.2 Curvature at the Edges	± 1.5% ± 0.5%	± 1.5% ± 0.5%	± 0.5%	+ 0.5/-0.3%	DIN EN ISO 10545-2
5.3 Skewness	± 1.5% ± 0.8%	± 1.5% ± 0.8%	± 0.5%	± 0.5%	DIN EN ISO 10545-2
6. Surface Quality	at least 95%	at least 95%	at least 95 %	at least 95 %	DIN EN ISO 10545-2
7. Color Deviations	•	•	•	•	DIN EN ISO 10545-16
7.1 Color Shade Grading	•	•	•	•	Deutsche Steinzeug
8. Size Grading	•	•	•	•	Deutsche Steinzeug
B) Physical Properties				glazed	
1. Water Absorption <small>on average / max. individual value</small>	A _{Ia} E ≤ 0.5%/0.6% A _{Ib} 0.5% < E ≤ 3%/3.3%	≤ 6/6.5%	B _{Ia} ≤ 0.5% B _{Ib} ≤ 3%	> 10%	DIN EN ISO 10545-3
2. Modulus of Rupture <small>Value in brackets = min. individual value</small>	A _{Ia} min. 28 (21) N/mm ² A _{Ib} min. 23 (18) N/mm ²	min. 20 (18) N/mm ²	B _{Ia} min. 35 (32) N/mm ² B _{Ib} min. 30 (27) N/mm ²	thkns. < 7.5mm: 15 N/mm ² thkns. ≥ 7.5mm: 12 N/mm ²	DIN EN ISO 10545-4
2.1. Breaking Strength ≥ 7.5 mm tickness	A _{Ia} min. 1300 N A _{Ib} min. 1100 N	at least 950 N	B _{Ia} min. 1300 N B _{Ib} min. 1100 N	at least 600 N	DIN EN ISO 10545-4
2.2. Break. Str. < 7.5 mm thickness	at least 600 N	at least 600 N	at least 700 N	at least 200 N	DIN EN ISO 10545-4
3. Resistance to Shock	•	•	•	•	DIN EN ISO 10545-5
4. Resistance to Deep Abrasion	≤ 275 mm ³	≤ 393 mm ³	≤ 175 mm ³	–	DIN EN ISO 10545-6
5. Resistance to Glaze Abrasion	0-5	0-5	0-5	0-5	DIN EN ISO 10545-7
6. Max. Coefficient of Expansion	•	•	•	•	DIN EN ISO 10545-8
7. Thermal Shock Resistance	•	•	•	•	DIN EN ISO 10545-9
8. Moisture Expansion	< 0.001mm/m	< 0.001mm/m	appr. 0.001mm/m	appr. 0.01mm/m	DIN EN ISO 10545-10
9. Resistance to Glaze Cracking	required	required	required	required	DIN EN ISO 10545-11
10. Thermal Conductivity	appr. 1 W/mK	appr. 1 W/mK	appr. 1 W/mK	appr. 0.8 W/mK	Deutsche Steinzeug
11. Electrical Leakage Resistance	> 10 ¹⁰ Ohm ³	> 10 ¹⁰ Ohm ³	10 ¹⁰ Ohm	10 ¹⁰ Ohm	DIN EN 1081
12. Steam Diffusion Resistance	ca. μ 120.000	ca. μ 120.000	ca. μ 120.000	ca. μ 100.000	DIN EN ISO 12572
13. Resistance to Frost	required	not required, but met by Agrob Buchtal	required	–	DIN EN ISO 10545-12
14. Light an Color Fastness	•	•	•	•	DIN 51094
15. Luminance	acc. to specifications	acc. to specifications	acc. to specifications	acc. to specifications	Deutsche Steinzeug
16. Behaviour in Fire	A1/A1 _{fl}	A1/A1 _{fl}	A1/A1 _{fl}	A1/A1 _{fl}	DIN 4102/DIN EN 13501-1
C) Chemical Properties²⁾					
1. Resistance to Chemicals	see test certificate	see test certificate	see test certificate	see test certificate	DIN EN ISO 10545-13
2. Resistance to Household Chemicals and Bath Water Additives	min. GB or UB	min. GB or UB	min. GB or UB	–	
3. Stain Resistance (glazed)	min. class 3	min. class 3	min. class 3	min. class 3	DIN EN ISO 10545-14
4. Lead and Cadmium Delivery	•	•	•	•	DIN EN ISO 10545-15
5. Hytect	see test certificate	see test certificate	see test certificate	see test certificate	Deutsche Steinzeug
D) Slip resistance					
1. Coefficient of Friction	•	•	•	–	E-DIN EN ISO 10545-17
1.1 Industrial Areas (BG) Trade Associations	Groups R9-13/V4-10	Groups R9-13/V4-10	Groups R9-13/V4-10	–	DIN EN 16165, Annex B DGUV-R 108-003 (BGR 181)
1.2 Barefoot Areas (BUK) German National Association of Accident Insurance Companies	Groups A/B/C	Groups A/B/C	Groups A/B/C	–	DIN EN 16165, Annex A DGUV-I 207-006 (GUV-I 8527)

1) Boxes marked according to size and color shade.

2) Hydrofluoric acid and its compounds excluded.

3) Exceptions:

KerAion ELA 10.6: Electrical Leakage Resistance 10⁶ Ohm (DIN EN 1081)
Eladuct 10⁸

All references to as well as quotations from product and test standards are to be considered as information which is not binding. The latest versions apply.

Deutsche Steinzeug tiles present better values than required by the standards.

In addition, they are construction biologically, ecologically, hygienically and bacteriologically safe; this is guaranteed through the choice of raw materials, method of processing and firing technique.

Terms and Classification according to DIN EN 14411

All our tiles consist of natural raw materials such as clay, quartz sand and feldspars, which are processed, refined and fired. Depending on the application they are manufactured with a glazed (GL) or unglazed (UGL) surface. They can be classified in accordance with DIN EN 14411 as follows:

Classification of the ceramic tiles according to their groups of water absorption (E) and their shaping

Shaping	Group I E ≤ 3%	Group IIa 3% < E ≤ 6%	Group IIb 6% < E ≤ 10%	Group III E > 10%
A extruded tiles	Group AIa E ≤ 0.5% (Annex M)	Group Alla-1a) (Annex B)	Gruppe Allb-1a) (Annex D)	Group All (Annex F)
	Group AIb 0.5% < E ≤ 3% (Annex A)	Group Alla-2a) (Annex C)	Group Allb-2a) (Annex E)	
B dry-pressed tiles	Group BIa E ≤ 0.5% (Annex G)	Group BIIa (Annex J)	Group BIIb (Annex K)	Group BIIIb) (Annex L)
	Group BIb 0.5% < E ≤ 3% (Annex H)			
a) The groups Alla and Allb are subdivided into two parts (parts 1 and 2) with different product requirements. b) Group BIII essentially applies to glazed tiles. There is a small number of dry-pressed unglazed tiles manufactured with a water absorption of more than 10 % to which this product group does not apply.				

Traditionally the following terms are used:

Extruded tiles

(marked with A)

Tiles that are cut off with a certain length from a bar formed from the plastic mass by means of an extruder.

Dry-pressed tiles

(marked with B)

Tiles that are formed from a finely ground and subsequently granulated mass by pressing under high pressure.

Stoneware tiles are frost-resistant, single extruded vitrified tiles with a firing temperature of appr. 1260 °C.

KerAion is the unique extruded ceramic large-size panel from Agrob Buchtal.

Vitrified dry-pressed tiles are frost-resistant, single dry-pressed tiles with a firing temperature of up to 1200 °C.

Porcelain stoneware stands for especially densely sintered tiles with a water absorption of < 0.5 %.

Mosaics are small (porcelain) stoneware tiles stuck onto sheets.

Earthenware tiles are non-frost-resistant, single dry-pressed tiles with a firing temperature of up to appr. 1100 °C.

The **water absorption E** in weight-% is determined in accordance with DIN EN ISO 10545-3.

Description of dimensions

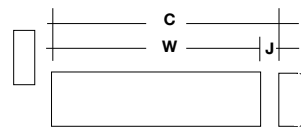

Coordinating dimension (C) in cm = Work size (W) + joint (J)

Work size (W) in mm = Dimensions of the visible surfaces and thickness (d)

Dimensions and Surfaces

1 - 5. Dimensions, DIN EN ISO 10545-2

All dimensions are determined in accordance with the standard.

Permissible length and width tolerances corresponding to the product standards						
DIN EN 14411	Group AIa / AIb (25x12.5 cm)		Group Alla (25x12.5 cm)		Group BIa / BIb (30x30 cm)	Group BIII (10x10 cm)
	„Nature“	„Precision“	„Nature“	„Precision“		
Deviation from the work size	± 2%, max. 4 mm	± 1%, max. 2 mm	± 2%, max. 4 mm	± 1.25%, max. 2 mm	± 0.6%, max. 2 mm	± 0.2%, max. 2 mm
Deviation from the average side length	± 1.5%	± 1.0%	± 1.5%	± 1.0%	± 0.5%	± 0.5%

All references to as well as quotations from product and test standards are to be considered as information which is not binding. The latest versions apply.

The work sizes of our **special pieces** are given according to visual sides.

6. Surface Quality, DIN EN ISO 10545-2

The surfaces of 1 m² or 30 pieces are tested at 300 lux for visible defects at a distance of 1 m.

7. Color Deviations, DIN EN ISO 10545-16

Glazed mono-colored products with values of Δ E_{cmc} < 0.75 are considered as identical in color; the value of 1.0 applies to unglazed mono-colored products.

7.1. Color Shade Grading

The color shade code is stamped on the box. Only identical color shades will result in a uniform surface look. In the case of rustic split tiles greater color deviations are normal. During laying, tiles from different boxes should be mixed.

8. Size Grading

The production sizes vary for technical reasons. The production size is coded and stamped on the box. Only boxes with the same coding should be laid together. According to VOB, the differences are evened out in the joints.

Physical Properties

1. Water Absorption, DIN EN ISO 10545-3

The **water absorption (E)** gives the weight increase as compared to the dry weight of samples saturated with water under vacuum.

1.1 Apparent Density, DIN EN ISO 10545-3

It gives the ratio between mass and external volume.

2. Modulus of Rupture, DIN EN ISO 10545-4

The breaking strength **F** is determined on samples by means of the three-point load in N. From this, the modulus of rupture and the breaking load are calculated according to the following formula.

Modulus of Rupture

$$R = \frac{3 \cdot F \cdot L}{2 \cdot b \cdot h^2}$$

F = breaking strength in N
L = bearing span in mm
b = width in mm
h = thickness in mm
R = modulus of rupture

Breaking Load

$$S = \frac{F \cdot L}{b}$$

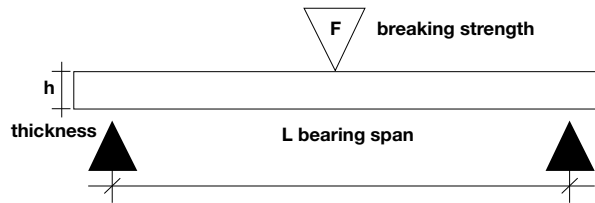

Possible Applications	Stress Group
Breaking strength under 1,500 N Housing construction and floor coverings subject to comparable mechanical stress, e.g. hotel bathrooms, rooms in the health service sector	1
Breaking strength 1,500 – 3,000 N Administration, trade and industry (practicable with vehicles with pneumatic tyres), e.g. canteen kitchens, canteens, traffic zones, car exhibition and maintenance areas, sales rooms, always without industrial truck traffic Floor pressures up to 2 N/mm ²	2
Breaking strength 3,000 – 5,000 N Trade and industry (industrial truck traffic with superelastic, solid rubber and vulkollan tyres), e.g. in food retailing and wholesaling, non-food retailing and wholesaling, shopping malls Floor pressures 2 to 6 N/mm ²	3
Breaking strength 5,000 – 8,000 N Trade and industry; areas of application as in group 3, but practicable with polyamide rollers Floor pressures 6 to 20 N/mm ²	4
Breaking strength above 8,000 N Trade and industry; heavy-duty areas with industrial truck traffic with polyamide rollers; runners of metal parts, such as e.g. in factory buildings, assembly halls and storerooms, repair workshops for machines and heavy equipment Floor pressures > 20 N/mm ²	5

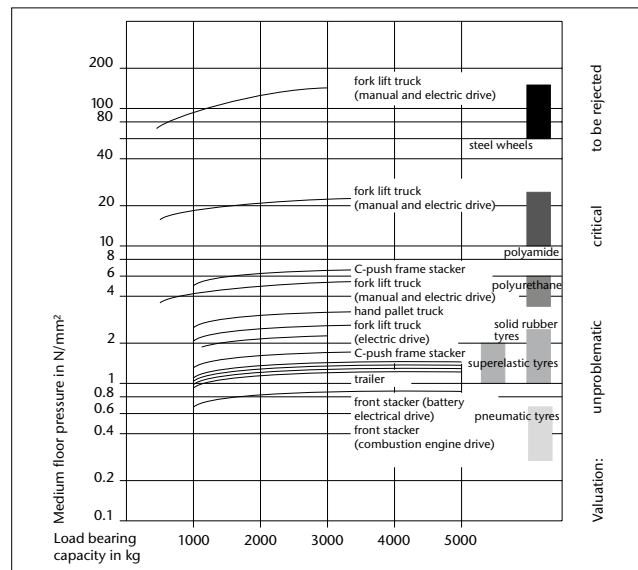

Floor pressures in N/mm² of industrial truck wheels according to a FMPA test in Stuttgart

The table illustrates the floor loads and indicates the effect of the different wheel types: steel wheels should be rejected and polyamide (Nylon and Perlon) is not advisable. Softer tyres (≤ 75 Shore-A-Hardness) as well as larger wheel diameters and wider supporting surfaces are especially advantageous.

Important note:

The "application possibilities" are of course only recommendations, as the method and quality of laying are decisive factors. Our recommendations are based on conventional, professional laying. With increasing mechanical load as well as harder tyres a thicker tile is required.

All references to as well as quotations from product and test standards are to be considered as information which is not binding. The latest versions apply.

Mechanical Strength

Deutsche Steinzeug offers tiles in thicknesses from 5 up to 20 mm for extreme loads in industrial and commercial areas. The breaking load values of our products partly are by far better than the values required by DIN EN 14411 (the relevant test certificates will be made available on request).

The calculated breaking load indicates the suitability for floors subject to mechanical loads. The stress itself is caused by bending rather than by pressure. The “extra strong” tiles from our programme with their high pressure, breaking and bending strength values are the ideal covering for floors subject to heavy loads. They withstand the wheels of industrial trucks, fork lift trucks and platform lift-trucks with their high floor pressure. They are especially suitable as floor coverings for industrial logistics, hyper- and supermarkets.

3. Compressive Strength

The compressive strength of tiles is not standardized. In the case of vitrified dry-pressed tiles it reaches values of up to 150 N/mm². The following conversion table shows the importance of a perfect and professional embedding of the tiles on site. The relatively low values for cement and thin-bed mortar can only be compensated by special and professional laying (mortar composition, water/cement value and manual or mechanical compression).

4. Resistance to Shock, DIN EN ISO 10545-5

Rebound measurement with 5 samples.

5. Resistance to Deep Abrasion, DIN EN ISO 10545-6

With regard to the deep abrasion on unglazed tiles, the abrasion is determined by means of fusion corundum and a rubbing plate. The lower the value, the higher the wear resistance of the material.

6. Glaze Abrasion, DIN EN ISO 10545-7

The **abrasion class** of glazed tiles is established in the wet test. Artificial abrasion is produced with the help of aluminium oxide grains, steel balls and the addition of water in an eccentrically revolving system. The number of revolutions at which a visible change of the test surface occurs results in the following classification:

Resistance to Surface Abrasion	
Class	Revolutions
0	100
1	150
2	600
3	750/1500
4	2100/6000/12000
5	>12000*

* Must pass the stain test according to DIN EN ISO 10545-14.

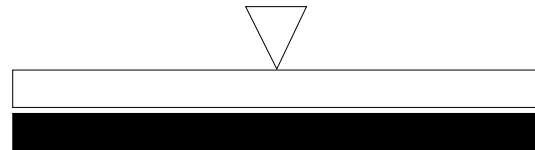

Vitrified material has a compressive strength approx. 10 - 20 times higher than cement mortar, cast plaster floors and reinforced concrete.

Conversion table for different materials

Types of material	N/mm ²	N/cm ²	kN/cm ²
Vitrified dry-pressed tiles	100 – 150	10.000 – 15.000	10 – 15
Extruded split tiles	180 – 250	18.000 – 25.000	18 – 25
Cement mortar Gr. III	10	1.000	1
High-grade cement mortar	20	2.000	2
Thin-bed mortar 15 – 30	1.500 – 3.000	1.5 – 3	
Epoxy resins 60 – 75	6.000 – 7.500	6 – 7.5	
Cement screed CT, C12 (ZE 12)	12	1.200	1.2
CT, C20 (ZE 20)	20	2.000	2
CT, C30 (ZE 30)	30	3.000	3
Mechanically resistant floor 65	65	6.500	6.5
Reinforced concrete C 20/25 (B 25)	25	2.500	2.5
C 30/37 (B 35)	35	3.500	3.5

Class 0

The use of glazed tiles of this class for floor coverings is not recommended.

Class 1

Floor coverings in areas mainly walked on in soft footwear or barefoot and not exposed to abrasive dirt (e.g. bathrooms and bedrooms without direct access from outside).

Class 2

Floor coverings in areas occasionally walked on with soft or normal footwear and exposed to only little abrasive dirt (e.g. rooms in living areas of houses, except kitchens, entrances and similar heavily frequented rooms). This does not apply to special footwear such as e.g. hobnailed boots.

Class 3

Floor coverings in areas frequently walked on with normal shoes and exposed to little abrasive dirt (e.g. kitchen-cum-living-rooms, halls, corridors, balconies, loggias and terraces). This does not apply to special footwear such as e.g. hobnailed boots.

Class 4

Floor coverings walked on regularly and exposed to little abrasive dirt, so that they are subject to greater stress as in the case of class 3 (e.g. commercial kitchens, hotels, exhibition and sales rooms).

Class 5

Floor coverings subject to heavy pedestrian traffic over long periods of time and exposed to little abrasive dirt, so that they are subject to the most extreme stress under which glazed tiles can be applicable (e.g. public areas such as shopping centres, entrance halls of airports, hotel foyers, public foot-paths and industrial applications).

Every floor covering is subject to wear. This depends on the area of application and the frequency of use, the kind and degree of dirt as well as the hardness and resistance to wear of the covering material. While unglazed vitrified floor tiles can be used practically anywhere, glazed floor tiles have to be categorized according to stress groups. Scrapers, mats and the like help to remove dirt and abrasives and to protect glazed floor coverings. Something of this kind has to be provided especially in rooms with direct access from outside or from the garden.

Extreme Stress

For such areas we recommend the use of integrally colored, unglazed tiles, which are available in a wide range of colors and sizes. Examples: floors subject to high traffic loads, e.g. in supermarkets, hotels, schools, administrative buildings, railway stations, hospitals, passageways, etc., taking into account the mechanical load.

7. Coefficient of Expansion, DIN EN ISO 10545-8

The coefficient of expansion is ascertained between room temperature and 100°C ermittelt. The measured values are at around $6.0 \times 10^{-6} \text{ m/(m}\cdot\text{K)}$ in the case of vitrified materials and at around $8.0 \times 10^{-6} \text{ m/(m}\cdot\text{K)}$ in the case of porcelain stoneware. At 8 m length and 50° temperature difference the result is a change in length of approx. 2.4 mm in the case of vitrified materials (in the case of screed/concrete 4.6 mm and steel 5.6 mm).

8. Thermal Shock Resistance, DIN EN ISO 10545-9

The thermal shock resistance is tested between 15° and 145°C.

9. Moisture Expansion, DIN EN ISO 10545-10

The moisture expansion is determined between tempered and water-saturated samples.

10. Resistance to Glaze Cracking, DIN EN ISO 10545-11

This test takes place in the autoclave at 500 KPa with subsequent color control.

Glazes with hair cracks/crazes are marked as such and require the wetting of the covering prior to pointing to avoid deposits of fine particles of the pointing mortar in the hair cracks. Colored pointing compounds are not suitable in the case of these glazes. The glaze surfaces must not be marked with felt-tip pen and the like.

11. Thermal Conductivity etc.

Thermal conductivity, heat radiation and storage capacity as well as the thermal resistance are not standardized. Vitrified material produces the following approximate values:

Thermal conductivity:	1 W/mK	Heat storage capacity:	0.8 kJ/kgK
Heat radiation:	5.3 W/m ² K ⁴	Thermal resistance:	0.01m ² K/W

12. Electrical Leakage Resistance

With a volume resistance of $>10^{10} \text{ Ohm}$ (DIN EN 1081), our ceramics is insulating in dry condition. With the series Eladuct and KerAion ELA 10.6, however, we offer ceramics for floors capable of discharging static electricity. The glaze of ELA 10.6 has a surface resistance of approx. 10^6 Ohm according to DIN EN 1081. The discharge of static electricity is effected from the glaze via conductive joints and tile adhesive into copper strips to be connected to earth, which are laid on the base to be tiled. In the case of Eladuct, the complete tile body is capable of discharging static electricity. The volume resistance according to DIN EN 1081 is approx. 10^9 Ohm . Here, conductive joints are not required; apart from that, the base has to be carried out as described for ELA 10.6.

13. Steam Diffusion Resistance

According to DIN EN ISO 12572 the steam diffusion resistance is approx. $\mu 120,000$ in the case of vitrified material/split tiles and $\mu 100,000$ in the case of earthenware (excluding joints).

14. Resistance to Frost, DIN EN ISO 10545-12

The test for frost resistance is carried out on 10 samples or > 0.25 m² samples. After water saturation under vacuum the samples are checked for defects after 100 frost-thaw alternations.

The resistance to frost of an outdoor flooring, however, does not only depend on the quality of the ceramic tiles used.

Professional construction and laying are essential. For this, please refer to our specifications and the notice of the umbrella organization of the German building and construction industry "Outdoor Tiled and Paved Coverings".

15. Light and Color Fastness

Both glazed and unglazed ceramics are light- and color-fast according to DIN 51094.

16. Luminance

The lightness value of a tile describes the brightness of the surface as perceived by the human eye. The measuring value $Y = 100$ corresponds to the brightness of an absolutely white surface, and $Y = 0$ to that of an absolutely black surface. The lightness value is determined for mono-colored tiles.

17. Behaviour in Fire

Ceramic tiles are classified A 1 according to EN ISO 13501-1 and DIN EN 14411. Therefore, they are generally non-combustible and thus fire-resistant. Also in the case of fire they do not release any toxic emissions.

Chemical Properties

1. Resistance to Chemicals, DIN EN ISO 10545-13**Resistance to Household Chemicals and Bath Water Additives**

- Household chemicals
 - Ammonium chloride solution 100 g/l
- Bath salts
 - Sodium hypochlorite solution 20 mg/l

Classes

A/B/C*

Resistance to Acids and Alkalis

- Low concentration (L)
 - a) Hydrochloric acid solution 3% (V/V)
 - b) Citric acid solution 100 g/l
 - c) Potassium hydroxide solution 30 g/l
- High concentration (H)
 - a) Hydrochloric acid solution 18% (V/V)
 - b) Lactic acid solution 5% (V/V)
 - c) Potassium hydroxide solution 100 g/l

Classes

LA/LB/LC or HA/HB/HC*

Acid Protection and Apparatus Engineering

The resistance for acid protection engineering DIN EN 993-16 or chemical apparatus engineering DIN 28062 is subject to individual tests.

* Class A shows the highest resistance to chemicals, which decreases more and more towards C.

2. Stain Resistance, DIN EN ISO 10545-14**Stain Forming Substances**

- Stain forming substances, leaving traces
 - Green stain forming substances in oil
 - Red stain forming substances in oil
- Chemical stain forming substances
 - Iodine, 13 g/l in alcohol
- Stain forming substances, forming a film
 - Olive oil

Cleaning (within the framework of the test)

- Cleaning agent
 - Hot water (+55 °C)
 - Weak cleaning agent
 - Strong cleaning agent
- Solvent
 - Hydrochloric acid solution 3% (V/V)
 - Potassium hydroxide 200 g/l
 - Acetone

Classes

Cl.5 / Cl.4 / Cl.3 / Cl.2 / Cl.1*

3. Lead and Cadmium Delivery

The glazed surfaces are exposed to a 4 percent acetic acid solution. Then, the quantity of the delivered lead and cadmium is determined.

* Class 5 shows the highest stain resistance, which decreases more and more towards 1.

Surface Coatings and Upgradings

Hytect

Hytect is a highly effective and durable coating of tiles and panels of Deutsche Steinzeug. The coating baked onto the surface on the base of titanium dioxide uses the principle of the photocatalysis. It offers the user the following advantages:

A) Hytect decomposes bacteria and germs

The surface is activated by sunlight or artificial lighting. Activated oxygen forms, which decomposes microorganisms.

B) Hytect eliminates disagreeable odours

Disagreeable or even unhealthy odours in the air are also eliminated by Hytect.

C) Hytect reduces the cleaning efforts

The hydrophilic surface makes it possible for water to get under the dirt. In this way the quantity of cleaning agents is considerably reduced, which means a contribution to environmental protection and the saving of time for manual works at the same time.

Hytect surfaces are odourless, non-poisonous, meet the requirements for food and are completely harmless for persons suffering from allergies.

Laying and pointing are carried out by the usual techniques. The conventional agents (without hydrofluoric acid and its compounds) are applicable for cleaning. All additives forming a film, leaving fat on the surface or impregnating are excluded, which impair the surface activation by light.

Renowned institutes in Germany and abroad have confirmed us the corresponding effects of Hytect.

Protecta Surface Upgrading



Better Beats Good ...

Unglazed vitrified tiles are hard-wearing and resistant by nature. Thanks to the Protecta surface upgrading, the stain and dirt resistance could be improved considerably: during the firing process, the coating applied **in-plant** is ceramically bonded to the biscuit and closes the existing "micropores" quite natural for unglazed ceramics. In this way, the penetration of substances forming stains is prevented. Thus, an impregnation is no longer required and may possibly even have a negative effect in the case of slip-resistant tiles with Protecta surface upgrading, as the impregnating agent can not penetrate the tile but remains on the surface as lubricating film.

Products with Protecta surface upgrading are marked with this symbol in the corresponding series:



Hygiene

Glazed tiles and tiles with Protecta surface upgrading of Deutsche Steinzeug ensure the best possible hygiene conditions. Thanks to the closed surface, they offer no possibility for germs to proliferate. Tests of institutes for hygiene confirm the suitability for the covering of drinking water reservoirs. Hyper-sensitive people such as those suffering from allergies make the best experiences with tiles.

Cleaning

On principle, claddings and coverings must be protected by appropriate measures against heavy soiling which may be caused in particular by subsequent construction works (painting etc.). Our tiles can generally be cleaned with water and a neutral or alkaline cleaning agent.

In the case of hard water, the sporadic use of acid cleaning agents is required. In the case of stains, cleaning depends on the type of stains and has to be carried out with suitable chemicals.

In the case of a higher concentration of the cleaning agent used, subsequent wiping with clear water is required. Rinsing with clear water is absolutely necessary when carrying out a basic cleaning.

Cleaning agents containing maintenance additives are not recommended by us. They usually reduce the slip resistance and cause a negative visual appearance of the floor covering by forming layers!

Important: the use of cleaning machines with pads containing abrasive grain has a polishing effect by which the slip resistance of the tiles is considerably reduced. We therefore expressly disapprove of such methods. Hydrofluoric acid or its compounds attack the ceramics and cause irreversible damage!

You will find detailed cleaning instructions for ceramic tiles on the Internet at www.agrob-buchtal.de

- Service
- Architects & Planners / Dealers / Tilers
- Cleaning instruction.

Impregnation

Unglazed stoneware without Protecta surface upgrading or Hytect coating should be impregnated in order to prevent the penetration of colored liquids, fats and oils and to facilitate cleaning.

The impregnating agent must be applied on the clean and dry floor; excess material must be removed immediately.

Slip Resistance

1. Coefficient of Friction/Slip Resistance

Workshop rules as well as accident prevention regulations require floors to be smooth, slip-resistant and easy to clean. Special protective measures against slipping are necessary where there is a risk as a result of the use of water, oil, slush, grease or waste. This should be taken into consideration when choosing the surface material. This clear requirement is based on investigations carried out by the insurance companies, which proved that slipping is the primary cause of accidents.

1.1. Industrial Areas

Competent authority:
 Deutsche Gesetzliche Unfallversicherung,
 Mittelstraße 51, 10117 Berlin-Mitte,
 phone: +49 (0)30 28876-3800,
 fax: - 3808, www.dguv.de, info@dguv.de
 Test standards: DIN EN 16165 and DIN 51133
 Guideline: ASR A 1.5 - Floors
 Code of practice: DGUV regulation 108-003 "Floors in work rooms and work areas with high risk of slipping" (previous BGR 181)
 Test procedure: Inclined plane, safety footwear worn, test medium oil. The surface finish can be smooth, fine-rough, rough or profiled.

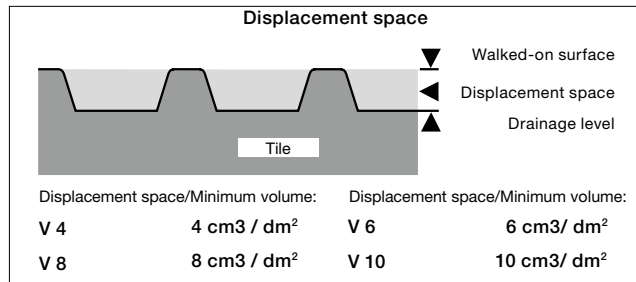

The displacement space (V4-V10) is the open space between the upper walked-on surface and the drainage level of profiled surfaces.

Valuation Groups

In a detailed table (see next page) the required valuation groups are assigned to work areas where there is a high risk of slipping. Information is available from Deutsche Gesetzliche Unfallversicherung and Agrob Buchtal.

Test on "inclined plane"

Valuation groups	Angle of inclination	Industrial + commercial areas
R9	> 6° - 10° low static friction	
R10	> 10° - 19° normal static friction	
R11	> 19° - 27° increased static friction	
R12	> 27° - 35° high static friction	
R13	> 35° very high static friction	

The indicated angles of inclination exclusively serve for the assignment of the valuation groups and can not be equated with the angles of inclination of slopes/ramps.

Slip-resistant tiles are marked with the logo "GRIP" in the corresponding series:



Legal Basis

Workshop rules as well as accident prevention regulations require floors to be smooth, slip-resistant and easy to clean. The brochure "Technische Regel für Arbeitsstätten" ASR. A 1.5 – Floors (Code of practice for work areas) contains detailed requirements.

Publisher:

Bundesanstalt für Arbeitsschutz und Arbeitsmedizin (Ausschuss für Arbeitsstätten) [Federal institute for safety at work and occupational medicine (Committee for work areas)]

Available at:

Download at www.baua.de

0 General work rooms and areas*

0.1	Entrance areas, indoors**)		R9
0.2	Entrance areas, outdoors	R11 (or R10 V4)	
0.3	Stairs, indoors***)		R9
0.4	Outdoor stairs	R11 (or R10 V4)	
0.5	Inclined ramps, indoor****) (from a slope of 3 %; e.g. for wheel chairs, compensation slopes, routes of transport)	One R-group higher than that required for the covering of the access area	V-Value of the covering of the access area, where applicable

0.6 Sanitary rooms

0.6.1	Toilets		R9
0.6.2	Changing rooms and washrooms		R10
0.7	Break rooms (e.g. recreation room, company canteens)		R9
0.8	First aid rooms and comparable facilities (see ASR A4.3)		R9

1 Manufacture of margarine, edible fats and oils

1.1	Melting of fat		R13 V6
1.2	Cooking oil refinery		R13 V4
1.3	Margarine production and packaging		R12
1.4	Cooking fat production and packing, oil bottling		R12

2 Milk processing, cheese production

2.1	Fresh milk processing and butter production		R12
2.2	Cheese production, storage and packaging		R11
2.3	Icecream manufacturing		R12

3 Chocolate and confectionery production

3.1	Sugar processing		R12
3.2	Cocoa production		R12
3.3	Production of raw mixtures		R11
3.4	Fabrication of chocolate bars and shells and filled chocolates		R11

4 Production of bread, cakes and pastries

	(bakeries, cake shops, production of long-life bakery products)		
4.1	Dough preparation		R11
4.2	Rooms in which predominantly fats or liquid mixtures are processed		R12
4.3	Washing-up rooms		R12 V4

5 Slaughtering, meat processing

5.1	Slaughter-house		R13
V10			
5.2	Tripe processing room		R13
V10			
5.3	Meat sectioning		R13 V8
5.4	Sausage kitchen		R13 V8
5.5	Boiled sausage unit		R13 V8
5.6	Raw sausage unit		R13 V6
5.7	Sausage drying room		R12
5.8	Gut store		R12
5.9	Salting and curing rooms, smoking establishments		R12
5.10	Poultry processing		R12 V6
5.11	Cold cuts and packaging unit		R12
5.12	Workshop with sales area		R12 V8 ****)

6 Fish processing, production of delicatessen

6.1	Fish processing		R13
V10			
6.2	Production of delicatessen		R13 V6
6.3	Manufacture of mayonnaise		R13 V4

7 Processing of vegetables

7.1	Production of sauerkraut		R13 V6
7.2	Vegetable tinning		R13 V6
7.3	Sterilizing rooms		R11
7.4	Rooms in which vegetables are prepared for processing		R12 V4

8 Wet areas in food and beverage production

	(if not specifically mentioned)		
8.1	Storage cellars		R10
8.2	Beverage bottling, fruit juice production		R11

9 Catering establishments

9.1	Kitchens in the catering trade (restaurant kitchens, hotel kitchens)		R12
9.2	Kitchens catering for homes, schools, day-care facilities for children, sanatoria		R11
9.3	Kitchens catering for hospitals, clinics		R12
9.4	Large kitchens catering for industrial and university canteens, and contract catering		R12
9.5	Food preparation kitchens (fast food kitchens, convenience restaurants and snack bars)		R12
9.6	Kitchens for heating up frozen meals		R10
9.7	Coffee and tea kitchens, hotel garni kitchens and ward kitchens		R10
9.8	Washing-up rooms		
9.8.1	Washing-up rooms for 9.1, 9.4, 9.5		R12 V4
9.8.2	Washing-up rooms for 9.2		R11
9.8.3	Washing-up rooms for 9.3		R12
9.9	Dining rooms, guest rooms, canteens including serving counters		R9
9.10	Counter area, bar area		R10

10 Cold stores, deep freeze stores

10.1	for unpacked goods		R12
10.2	for packed goods		R11

11 Sales outlets, shops

11.1	Reception of goods, meat		
11.1.1	for unpacked goods		R11
11.1.2	for packed goods		R10
11.2	Reception of goods, fish		R11
11.3	Serving counters for meat and sausage		
11.3.1	for unpacked goods (e.g. loose in transport boxes)		R11
11.3.2	for packed goods		R10
11.4	Serving counters for bread, cakes and pastries, unpacked goods		R10
11.5	Serving counters for dairy products and delicatessen, unpacked goods		R10
11.6	Serving counters for fish		
11.6.1	for unpacked goods		R12
11.6.2	for packed goods		R11
11.7	Serving counters, except for nos. 11.3 to 11.6		R9
11.8	Meat preparation rooms		
11.8.1	for meat preparation, except for no. 5		R12 V8
11.8.2	for meat processing, except for no. 5		R11
11.9	Florists shops		R11
11.10	Sales areas with ovens		
11.10.1	for the production of bread, cakes and pastries		R11
11.10.2	for the warming up of prefabricated bread, cakes and pastries		R10
11.11	Sales areas with chip pans or grills		R12
11.12	Shops, customer rooms		R9
11.13	Preparation areas for food for self-service shops (except for meat, fish and sausage)		R10
11.14	Cash register areas, packing areas		R9
11.15	Outdoor sales areas		R11 (or R10 V4)

12 Health service rooms

12.1	Disinfection rooms (wet)		R11
12.2	Pre-cleaning areas of sterilization		R10
12.3	Faeces disposal rooms, discharge rooms, unclean nursing work rooms		R10
12.4	Pathological facilities		R10
12.5	Rooms for medical baths, hydrotherapy, fango preparation		R11
12.6	Washrooms of operating theatres, plastering rooms		R10
12.7	Sanitary rooms, ward bathrooms		R10
12.8	Rooms for medical diagnosis and therapy, massage rooms		R9
12.9	Operating theatres		R9
12.10	Wards with hospital rooms and corridors		R9
12.11	Medical practices, day clinics		R9
12.12	Pharmacies		R9
12.13	Laboratories		R9
12.14	Hairdressing salons		R9

13 Laundry

13.1	Rooms with continuous-flow washing machines or with spin-drier		R9
13.2	Rooms with washing machines at which the clothes are taken out dripping wet		R11
13.3	Ironing rooms		R9

14 Fodder concentrate production

14.1	Dried fodder production		R11
14.2	Fodder concentrate production using fat and water		R11 V4

15	Leather production, textiles		29	Financial institutions	
15.1	Wet areas in tanneries	R13	29.1	Counter areas	R9
15.2	Rooms with fleshing machines	R13 V10			
15.3	Areas where leather scraps accumulate	R13 V10	30	Plant traffic routes in outdoor areas	
15.4	Rooms for making leather impermeable by means of grease	R12	30.1	Footpaths	R11 (or R10 V4)
15.5	Dye mills for textiles	R11	30.2	Loading platforms	
			30.2.1	covered	R11 (or R10 V4)
16	Paint shops		30.2.2	uncovered	R12 (or R11 V4)
16.1	Wet grinding areas	R12 V10	30.3	Sloping ramps (from a slope of 3 %; e.g. for wheel-chairs, loading platforms)	R12 (or R11 V4)
16.2	Powder coating	R11			
16.3	Painting	R10	30.4	Tank-up areas	
			30.4.1	covered	R11
17	Ceramics industry		30.4.2	uncovered	R12
17.1	Wet grinding mills (processing of ceramic raw materials)	R11	31	Parking areas	
17.2	Mixers; handling of materials like tar, pitch, graphite and synthetic resins	R11 V6	31.1	Garages, car-parks not exposed to weather influences****)	R10
17.3	Presses (shaping); handling of materials like tar, pitch, graphite and synthetic resins	R11 V6	31.2	Garages, car-parks exposed to weather influences	R11 (or R10 V4)
17.4	Moulding, pressure die casting areas	R12	31.3	Open-air parking areas	R11 (or R10 V4)
17.5	Glazing areas	R12	32	Swimming pools	
18	Glass and stone processing		32.1	Individual and common dressing rooms	R10
18.1	Stone cutting, stone grinding	R11	32.2	Sauna and relaxation areas	R10
18.2	Glass shaping of hollow glass ware, container ware	R11	32.3	Showers	R10
18.3	Grinding areas for hollow glass ware, flat glass	R11		NOT recommended by Agrob Buchtal! Please use R11 (in combination with valuation group B)!	
18.4	Insulating glass manufacture; handling of drying agents	R11 V6	32.4	Pool surrounds	R10
18.5	Packaging, shipping of flat glass; handling of anti-adhesive agents	R11 V6		NOT recommended by Agrob Buchtal! Please use R11 (in combination with valuation group B)!	
18.6	Etching and acid polishing facilities for glass	R11			
19	Cast concrete factories				
19.1	Concrete washing areas	R11	*) For floors in wet areas walked on barefoot, see DGUV information "Floor coverings in wet barefoot areas" (DGUV information 207-006).		
20	Storage areas				
20.1	Storage areas for oils and fats	R12 V6	**) Entrance areas according to number 0.1 are all areas with direct access from outside and in which moisture from outside can be brought (also see section 6 para. 3, utilization of products absorbing dirt and moisture). For adjoining areas or other rooms with large surfaces, section 4 para. 10 has to be observed.		
20.2	Storage areas for packed food	R10			
20.3	Outdoor storage areas	R11 (or R10 V4)			
21	Chemical and thermal treatment of iron and metal				
21.1	Pickling plants	R12	***) Stairs and ramps according to numbers 0.3 and 0.5 are those possibly exposed to moisture brought in from outside. For adjoining areas, section 4 para. 10 has to be observed.		
21.2	Hardening shops	R12			
21.3	Laboratory rooms	R11			
22	Metal processing, metal workshops				
22.1	Galvanizing shops	R12	****) If the same floor covering was laid in all areas, the displacement space can be lowered down to V4 after a risk assessment (taking into consideration the cleaning method, the working processes and the quantity of slippery substances on the floor).		
22.2	Grey cast iron processing	R11 V4			
22.3	Mechanical processing areas (turnery, milling shop), punching room, pressroom, drawing shop (pipes, wires) and areas exposed to increased stress by oil and lubricants	R11 V4	*****) The pedestrian areas which are not subject to a risk of slipping because of weather influences such as driving rain or moisture brought in.		
22.4	Parts cleaning areas, exhaust steam areas	R11 V4			
22.5	Partial cleaning areas, Damping areas	R12			
23	Vehicle repair workshops				
23.1	Repair and servicing bays	R11	Floors in rooms must not present any irregularities, cavities or dangerous slopes; stumbling must be impossible on these floors. They must be secured against shifting or tilting (e.g. in the case of covers), load-bearing and slip-resistant.		
23.2	Working and inspection pits	R12 V4			
23.3	Car washing halls, washing areas	R11 V4			
24	Aircraft repair workshops				
24.1	Aircraft hangars	R11	Floors are to be designed without inclination. Exception: functional inclinations outside of permanently installed workplaces, e.g. for the drainage of liquids or for bridging differences in height, e.g. with walkable sloping ramps.		
24.2	Repair hangars	R12			
24.3	Washing halls	R11 V4			
25	Sewage treatment plants				
25.1	Pump rooms	R12	In areas which must be continuously frequented in the scope of their normal utilization, the slip resistances of the different floor surfaces must not differ from each other to such an extent that there may be a risk of stumbling and slipping.		
25.2	Rooms for sludge draining facilities	R12	This may be the case if adjoining floor surfaces differ with regard to slip resistance:		
25.3	Rooms for screening equipment	R12	1. by more than one R-group in the case of two adjoining areas.		
25.4	Stands of workplaces, scaffolds and maintenance platforms	R12	2. by more than two R-groups if the transition to a different slip resistance is clearly visible or is to be expected (e.g. in the case of door passages).		
26	Fire brigade buildings		If there is a risk of stumbling or slipping due to different slip resistances, appropriate measures have to be taken, such as transition zones which are at least 1.5 m long in the direction of walking.		
26.1	Vehicle parking places	R12	Note: It is recommended to design the slip resistance of a floor within a working area as uniformly as possible, e.g. by making sure that other surface qualities within the floor covering, such as covers, markings or films glued on the floor, do not differ from each other by more than one R-group.		
26.2	Rooms for hose maintenance equipment	R12			
27	Functional rooms in the respiratory protection training facility				
27.1	Preparation room	R10	Entrances of buildings have to be designed in such a way that dirt and moisture brought in do not cause a risk of slipping. A sufficiently large roofing above entrances of buildings is an appropriate measure for this.		
27.2	Fitness room	R10	Inside the building, this can be achieved by providing clean-off zones in the form of mats absorbing the dirt and the moisture, which are specially designed for the expected pedestrian traffic with regard to their length, width and the material used and are at least 1.5 m long in the direction of walking over the whole width of the passage.		
27.3	Training room	R11	Clean-off zones must be secured against shifting and must not cause a risk of slipping, e.g. by being flush with the directly adjoining floor covering.		
27.4	Sluice	R10	Depending on the degree of soiling, clean-off zones must be cleaned or replaced in such a way that their functionality is maintained.		
27.5	Target room	R11			
27.6	Acclimatization room	R11			
27.7	Control room	R9			
28	Schools and day-care facilities for children				
28.1	Entrance areas, corridors, assembly halls	R9			
28.2	Class rooms, group rooms	R9			
28.3	Stairs	R9			
28.4	Toilets, washrooms	R10			
28.5	Instructional kitchens in schools (see no. 9.2, 9.6 or 9.7)	R10			
28.6	Kitchens in day-care facilities for children (also see no. 9)	R10			
28.7	Machine rooms for wood processing	R10			
28.8	Special rooms for handicrafts	R10			
28.9	Schoolyards	R11 (or R10 V4)			

No responsibility is taken for the correctness of the information.
Validity at the time of printing, subject to changes in the meantime.

Depending on the operational exposure to slippery substances to be expected, floors in working rooms and areas must be provided with a discharge facility, if required.
 The surfaces adjoining discharge openings as well as drain channels should have a slope of at least 2 per cent in order to facilitate the draining of fluid liquids. These areas should preferably be located outside of traffic routes. The discharge of liquids via traffic routes should be avoided, if possible.

Floor surfaces which normally are wet and have to be walked on barefoot, e.g. in swimming pools as well as sanitary rooms such as washing and changing rooms, must be suitable for ensuring safe walking.

1.2. Barefoot areas

Competent authority:
 Deutsche Gesetzliche Unfallversicherung, Mittelstraße 51, 10117 Berlin-Mitte, tel.: +49 (0)30 28876-3800, fax: - 3808, www.dguv.de, info@dguv.de, www.unfallkassen.de.
 Floors in wet barefoot areas, e. g. swimming pools, hospitals as well as dressing rooms, washrooms and showers in sports and work facilities.
 Test standard: DIN EN 16165.
 Code of practice: DGUV information 207-006 "Floor coverings in wet barefoot areas" (previous GUV-I 8527).
 Testing method: Inclined plane, walked on barefoot, wetting agent solution as test medium.
 The surfaces are smooth, micro-rough or slightly profiled. "Nonslip" glazes with their micro-rough surfaces have proved to be excellent in practice.
 The various areas are assigned to the valuation groups. Information can be obtained from Deutsche Gesetzliche Unfallversicherung and Agrob Buchtal.

Valuation group C

- Ladders and stairs leading into the water
- Stairs up to diving facilities and water slides
- Surfaces of diving platforms and diving boards over the length reserved for the diver (the slip-resistant surface of the diving platforms and diving boards must cover the front edge where the hands and the toes of the divers grip)
- Walk-through pools
- Inclined pool edge designs
- Kneipp basins, water-treading basins
- Ramps in the pool surround area with an inclination > 6 %
- Starting blocks

Walkable seating areas such as e.g. stands and pedestals near the pool into which moisture can be brought must be treated like floor coverings. If barefoot areas are regularly also walked on with footwear, the requirements according to ASR A1.5/1,2 must be observed in addition.



Valuation group A

- Barefoot passages and sanitary areas (nearly dry)
- Individual and common dressing rooms
- Pool floors in non-swimmer areas if the water depth is more than 80 cm in the entire area
- Sauna and relaxation areas (nearly dry)

Valuation group B

- Barefoot passages and sanitary areas, if not classified in group A
- Showers
- Steam baths
- Area of disinfecting spray facilities
- Pool surrounds
- Pool floors in non-swimmer areas if the water depth is less than 80 cm in certain areas
- Non-swimmer sections of wave-action pools
- Movable floors
- Paddling pools
- Ladders and stairs outside the pool area , if not classified in group C
- Accessible surfaces of diving platforms and diving boards, if not classified in group C
- Sauna and relaxation areas, if not classified in group A

Test on "inclined plane"

Valuation groups	Angle of inclination	Barefoot area
A	≥12°	
B	≥18°	
C	≥24°	

The indicated angles of inclination exclusively serve for the assignment of the valuation groups and can not be equated with the angles of inclination of slopes/ramps.

All references to as well as quotations from product and test standards are to be considered as information which is not binding. The latest versions apply.

1.3. Measurement of sliding friction

Competent authority:

Deutsche Gesetzliche Unfallversicherung, Mittelstraße 51, 10117 Berlin-Mitte, tel.: +49 (0)30 28876-3800, fax: - 3808, www.dguv.de, info@dguv.de, www.unfallkassen.de.

Test standard: DIN 51131

Code of practice: DGUV information 208-041 "Assessment of the risk of slipping under operating conditions" (previous GUV-I 8687).

This test is not a type examination and thus is neither suitable for the choice of floor coverings at the planning stage nor for classification in a slip-resistance valuation group. The method can be applied, e.g. for assessing the success of cleaning measures or in the event of planned changes of utilisation.

For the choice of a floor covering, DGUV information 108-003 (previous BGR 181) and DGUV information 207-006 (previous GUV-I 8527) respectively must be applied exclusively!

1.4. Private areas

With regard to slip resistance, ceramic floor coverings in private areas are not subject to standard regulations. Independent of that, however, we recommend that you choose slip-resistant tiles according to your personal safety requirements.

Color Shade Variation

"Color shade variation" refers to the variations in color between the tiles of a certain color, i.e. the degree of shading. Our products are classified into 4 shading coefficients.

V0 = No variation / no play of colors

V1 = Low variation / low play of colors

V2 = Medium variation / medium play of colors

V3 = High variation / high play of colors

V4 = Strong variation / strong play of colors

Mosaics glued thermoplastically on back: Permanently safe also in wet areas

The thermoplastic glueing of mosaics of the brands Agrob Buchtal and Jasba is also perfectly suitable for permanently wet and underwater areas. Analyses of independent institutes have proved that no microbiological infestation at the glass fibre net occurs under normal hygienic conditions. With the values $>0.5\text{N/mm}^2$, the bonding behaviour after dry and wet storage is better than the values required according to DIN EN 12004. Thus, the thermoplastic glueing on back can be recommended not only for dry areas but also for underwater areas (swimming pools and whirlpools) as well as for per-

manently wet areas such as showers and pool surrounds. In addition, the glueing on back facilitates laying and leads to considerable time saving compared to the film on the face side required so far. The glass fibre net on the back largely prevents the penetration of tile adhesive in the joints. The time-consuming removal of the film and possible residues on the tile surface is no longer necessary, and the cladding of columns and curvatures is significantly simplified.

List of Addresses

Bundesanstalt für Arbeitsschutz und Arbeitsmedizin (BAuA)

(Federal institute for safety at work and occupational medicine)
 Friedrich-Henkel-Weg 1-25, 44149 Dortmund
 Telephone: +49-231-9071-0, Fax: -2454,
 www.baua.de, poststelle@baua.bund.de

DGUV Rules and Regulations (BG/GUV)

Deutsche Gesetzliche Unfallversicherung
 Mittelstraße 51, 10117 Berlin-Mitte,
 Telephone: +49-30-28876-3800, Fax: -3808,
 www.dguv.de, info@dguv.de

DIN/EN/ISO Standards Sheets

Deutsches Institut für Normung e.V., 10772 Berlin
 Telephone: +49-30-2601-0, Fax: -60,
 www.din.de, info@din.de,
 Available from:
 Beuth Verlag GmbH, Burggrafenstraße 6,
 10787 Berlin, Telefon: +49-30-2601-2201-0, Fax: -1260,
 www.beuth.de, info@beuth.de

KOK-Directives for Swimming Pool Construction

RK-List of Tested Cleaning Agents
 DGfB Rules and Regulations
 Deutsche Gesellschaft für das Badewesen e.V.,
 45130 Essen
 Telephone: +49-201-87969-0, Fax: -20,
 www.baederportal.com, info@baederportal.com
 Directly available from the publisher

Bundesverband Keramische Fliesen e. V.

Luisenstraße 44, 10177 Berlin
 Telephone: 030/27 59 59 74-0, Fax: -99
 www.fliesenverband.de, info@fliesenverband.de

ZDB Notices

Professional Association for Tiles and Natural Stone in the
 Central Association of the German Construction Industry
 Kronenstr. 55-58, 10117 Berlin-Mitte,
 Telephone: +49-30-20314-0, Fax: -419,
 www.fachverbandfliesen.de, info@fachverband-fliesen.de
 Available from:
 Verlagsgesellschaft Rudolf Müller GmbH & CoKG,
 Stolberger Straße 84, 50933 Köln
 Postfach: 410949, 50869 Köln
 Telephone: +49-221-5497-112, Fax: -6112
 www.baufachmedien.de, service@rudolf-mueller.de

Quality Controls

Quality controls are carried out by:

- manufacturers themselves with strict sorting
- controls and special tests by the Deutsche Steinzeug laboratorien
- individual and batch testing by external material testing institutions in Germany and abroad

Certificates

The characteristics and the quality of our products are constantly tested by acknowledged material testing institutions. The corresponding test certificates are available.



* We will be pleased to make a survey of the certified individual products available to you on request.

Shower Tub System – Area Pro/Plural non-slip/Plural unglazed/Basis 3

The shower tub system consists of special tiles for realizing a shower tub integrated in the tile covering.

The shower tub system is a registered design. It meets the requirements of DIN 18040 “Barrier-free building” and DIN 18025 “Barrier-free living”.

In Germany, the 10 mm lip means that it is possible to take full advantage of various housing grants.

The 100 mm modular dimension inclusive of a 3 mm wide joint guarantees perfectly hygienic tile coverings with a narrow joint width and accurately sized tiles.

As with all slip-resistant surfaces of Plural non-slip/Plural unglazed, the series Basis 3, the surfaces of both the glazed and the ceramically upgraded unglazed tiles are very easy to clean.

The shower tub system is predestined for wet areas in hospitals, sanatoriums, rehabilitation centres, old people’s and nursing homes, but also for showers in commercial areas, swimming pool, sauna and sports facilities, hotel and private bathrooms.

1. The shower tub is a module with the necessary slope that can be integrated in the joint grid of the tile covering as required.

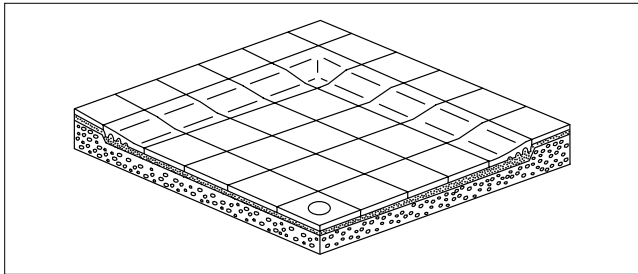

2. In combination with the cove skirting laid horizontally, a rounded transition between floor and wall covering is possible.

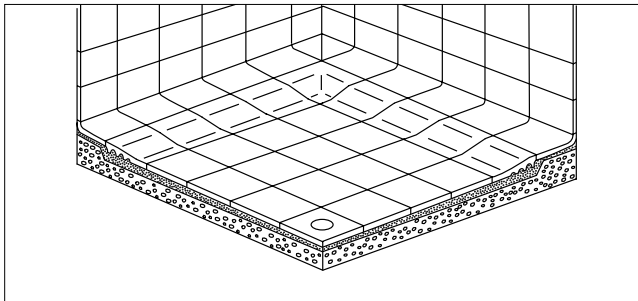

**Area Pro, Plural non-slip,
Plural unglazed**

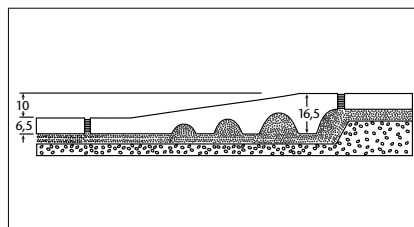
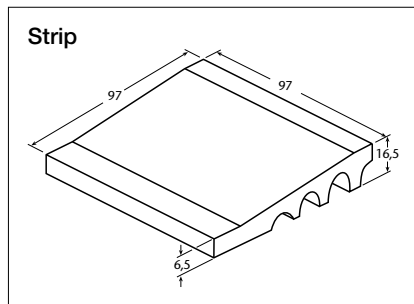
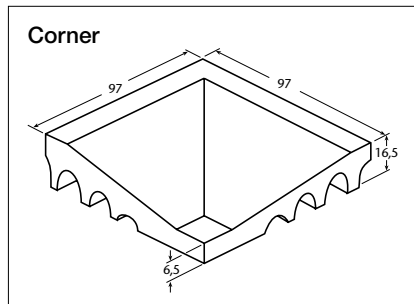

Basis 3 Softcorn

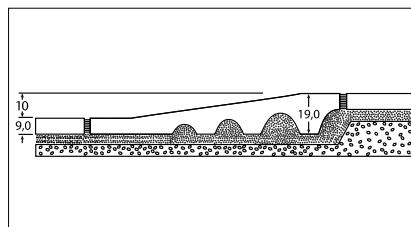
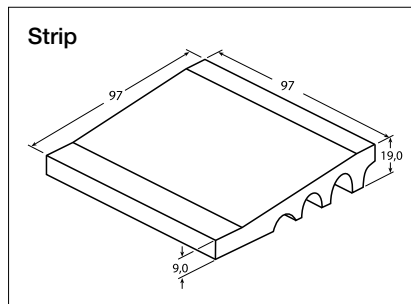
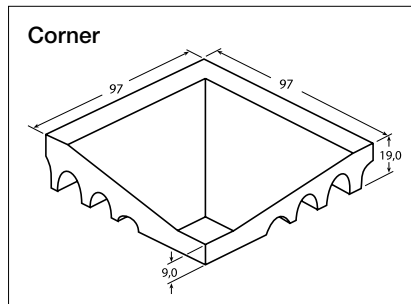

All references to as well as quotations from product and test standards are to be considered as information which is not binding. The latest versions apply.

The Shower Tub System of the Series Chroma / Chroma unglazed – Quantum

This shower tub system consists of only two components: the strip and the one-piece corner belonging to it.

A peculiarity of the system is the special form of the slope which provides a difference in height of 10 mm. The edge of the shower tub designed in this manner is easy to pass on foot and with a wheel-chair. The relevant requirements (DIN 18040 or 18025) with regard to barrier-free construction taking into account the needs of senior and handicapped persons are effectively supported in this way.

Thanks to the “integrated slope” the time-consuming execution of the edge of the shower tub on site is no longer required, and together with the even lower side facilitating laying the processing of these tiles is absolutely simple:

The shower tub system is perfectly completed by the series Chroma / Chroma unglazed – Quantum.

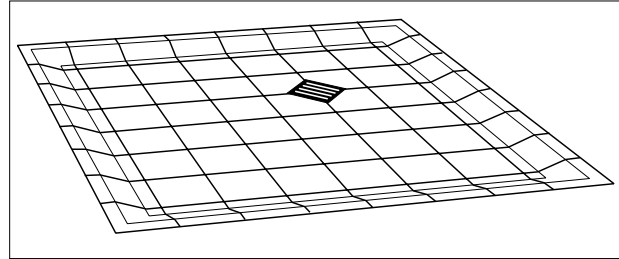

The shower tub system is based on a grid size of 12.5 x 12.5 cm. This permits a very variable dimensioning of the shower tub independent of standard dimensions and a harmonious integration in the shower installation or sanitary block.

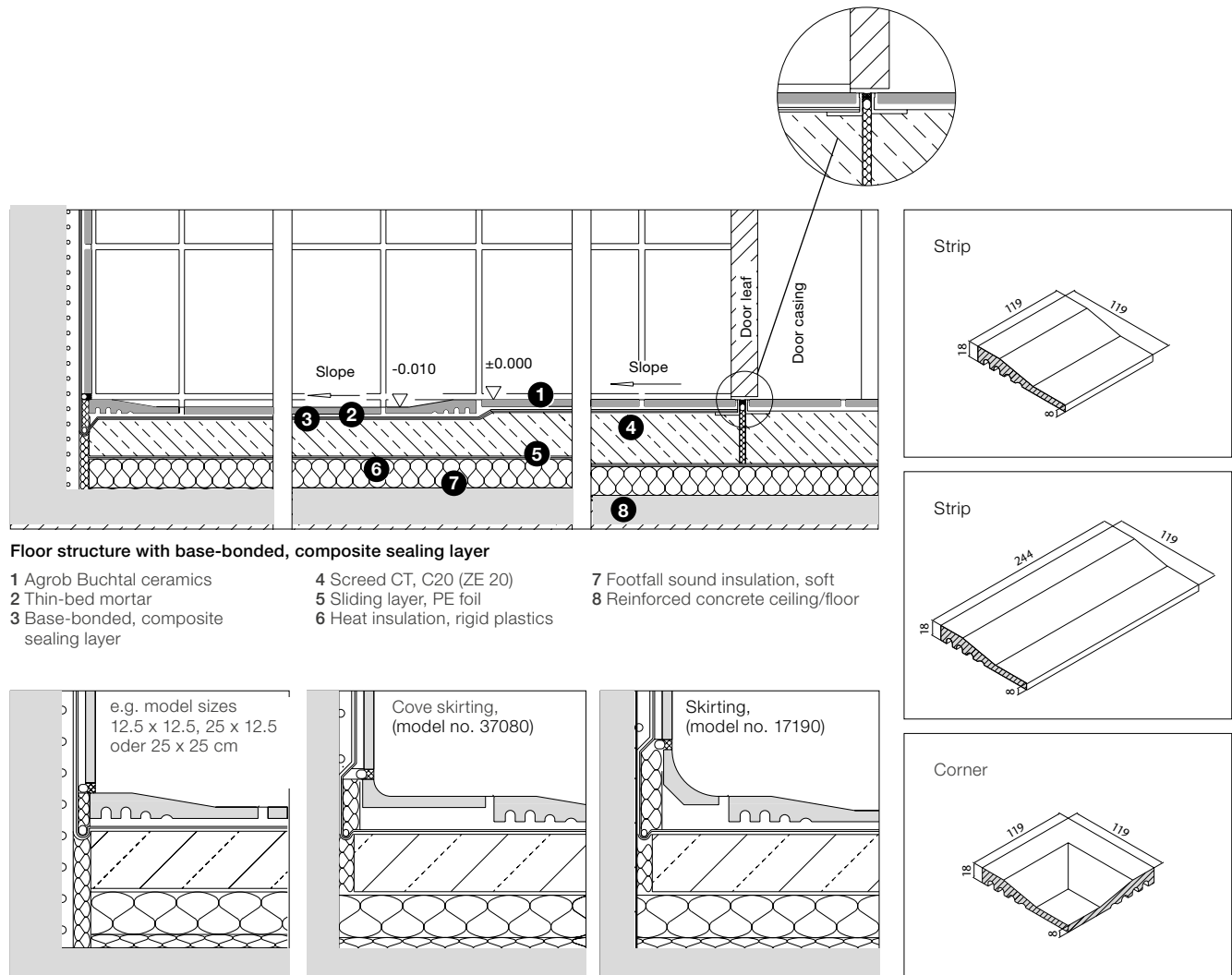

Wall connection variants

The shower tub systems of Agrob Buchtal are laid on a continuous screed and therefore do not require a high-maintenance movement joint between shower tub and adjoining areas.

All references to as well as quotations from product and test standards are to be considered as information which is not binding. The latest versions apply.

Cove Skirting

Cove Skirting 10 x 10 cm

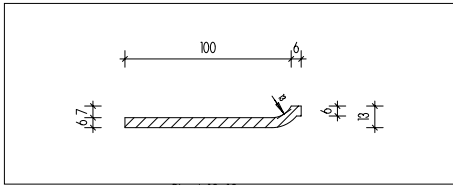

Fitting to:

Area Pro, smooth, 10 x 10 cm, unglazed
Plural/Plural non-slip, smooth and slip-resistant, 10 x 10 cm
Basis 2, smooth, 10 x 10 cm, glazed
Basis 3, smooth, 10 x 10 cm, unglazed
Plural unglazed, smooth, 10 x 10 cm

Cove Skirting 10 x 15, 10 x 20, 10 x 30 and 10 x 60 cm

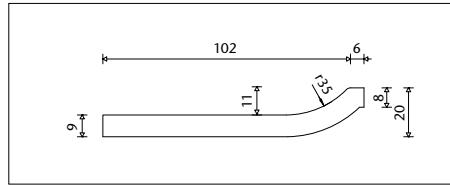

Fitting to:

Emotion GRIP, smooth oder Softcorn, 10 x 20, 10 x 30 cm, unglazed
Basis 3, smooth, 10 x 15, 10 x 20 cm, unglazed
Basis Pro, smooth, 10 x 30 cm, unglazed
Area Pro, smooth, 10 x 20, 10 x 30 and 10 x 60 cm, unglazed

Cove Skirting 10 x 25, 10 x 50 and 10 x 60 cm

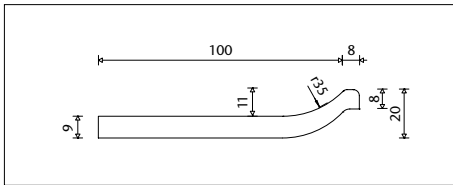

Fitting to:

Ascona, strukturiert, 10 x 25, 10 x 50, 10 x 60 cm, glazed
Nova, smooth, 10 x 60 cm, glazed
Quarzit, strukturiert, 10 x 60 cm, glazed

Cove Skirting 12.5 x 25 cm

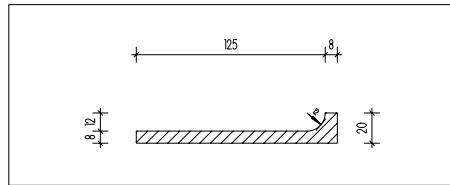

Fitting to:

Chroma unglazed, smooth, 12.5 x 25 cm, unglazed

Cove Skirting 12.5 x 25 cm

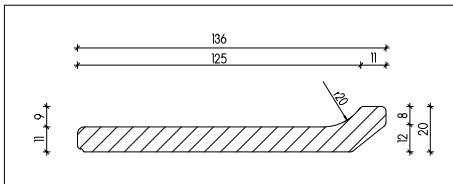

Fitting to:

Ferrum, smooth, 12.5 x 25 cm, unglazed

Internal Corner

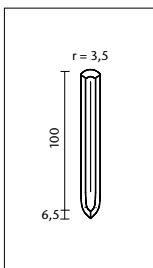

Fitting to
cove skirting:

Plural non-slip,
10 x 10 cm, glazed

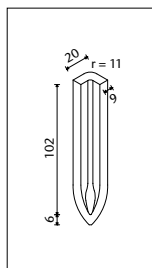

Fitting to
cove skirting:

Area Pro,
10 x 10, 10 x 20, 10 x 30,
10 x 60 cm, unglazed

Emotion GRIP,
10 x 20 und 10 x 30 cm, unglazed

Basis 3,
10 x 20 cm, unglazed

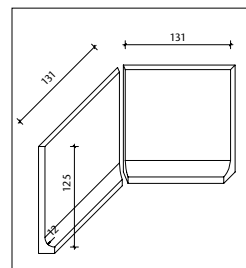

Fitting to
cove skirting:

Chroma unglazed,
12.5 x 25 cm, unglazed

External corner

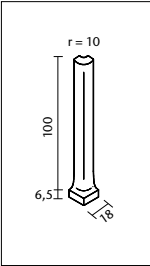

Fitting to cove skirting:
Plural non-slip,
 10 x 10 cm, glazed

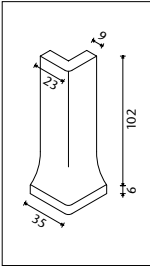

Fitting to cove skirting:
Area Pro,
 10 x 10, 10 x 20, 10 x 30,
 10 x 60 cm, unglazed
Emotion GRIP,
 10 x 20 und 10 x 30 cm,
 unglazed
Basis 3,
 10 x 20 cm, unglazed

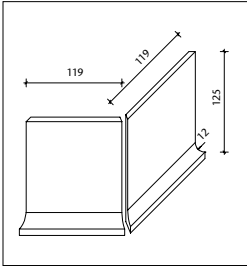

Fitting to cove skirting:
Chroma unglazed,
 12.5 x 25 cm, unglazed

Cove skirtings, cut/glued 15 x 60 cm and internal corners 15 x 15 cm

Details: Can be manufactured from any tiles/panels. The look and the haptics correspond to those of the adjoining surface, i.e. both the same structure and the same color are guaranteed. Minimum order quantity for the skirtings: 50 pieces; corner: 50 pieces.

Scale 1:5

- 1 UW Silicone
- 2 Closed-cell PE foam cord or seperating foil
- 3 Water-resistant elastic filling material
- 4 Heat insulation, rigid foam
- 5 Footfall sound insulation, soft
- 6 Mortar / adhesive
- 7 Sliding layer, PE foil
- 8 Thin-bed laying on rendering
- 9 Base-bonded sealing layer
- 10 Solid backfill

Stair safety borders / stair tiles

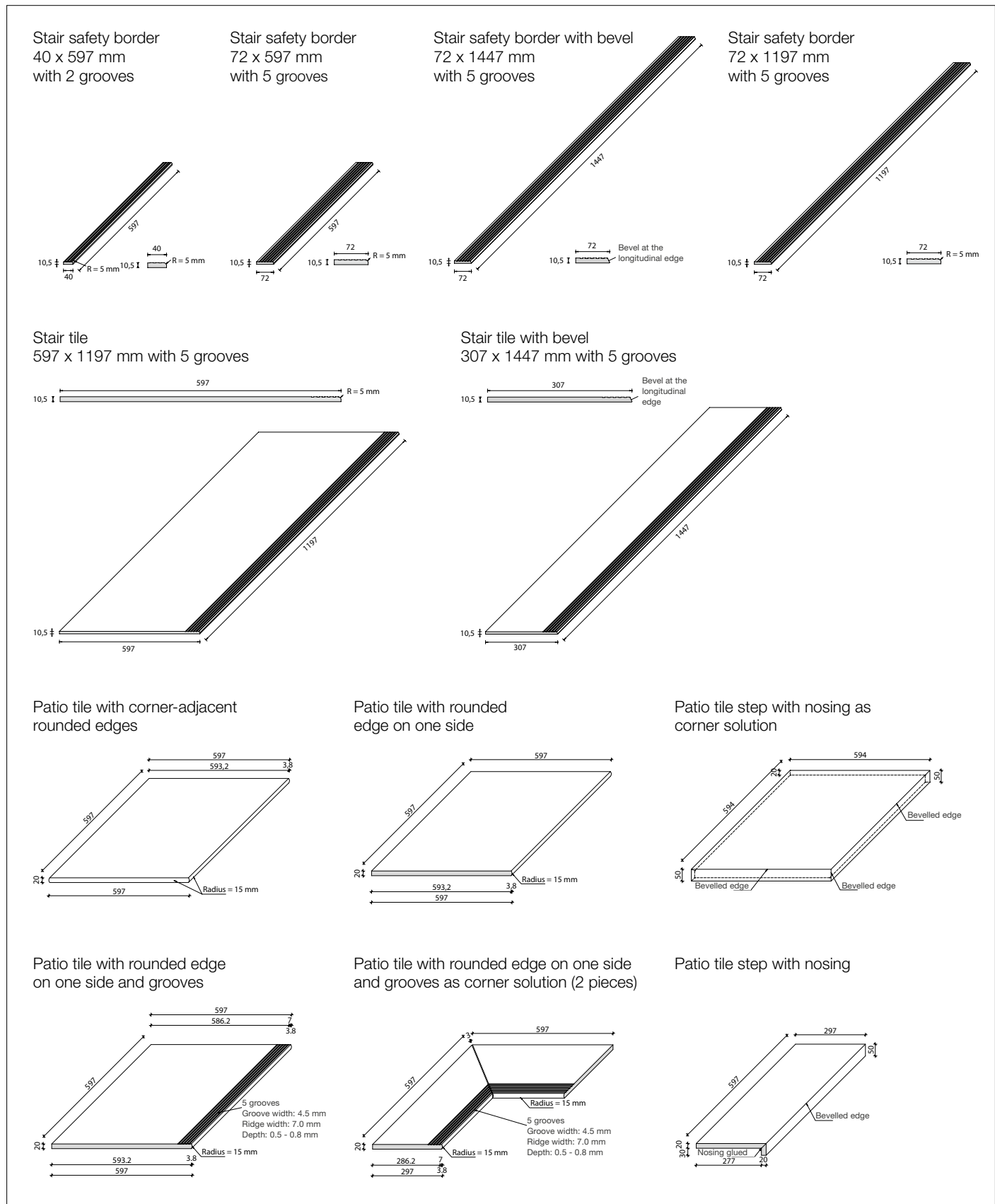

1. Construction Products Regulation (CPR)

The CPR distinguishes itself from the previous Construction Products Directive (CPD) above all by the Declaration of Performance, CE marking as well as assessment and verification of the constancy of performance of the product concerned.

Construction products brought into circulation after 1 July 2013 must comply with the CPR. "Bringing into circulation" means that a construction product is made available on the European market for the first time by the manufacturer. We would like to point out that the term of "provision" is delineated from that; it means the passing on of a construction product brought into circulation in the supply chain, e.g. from the specialist tile trade to end consumers.

Essential characteristics of a construction product – here ceramic tiles – are defined in Annex ZA of the harmonised standard DIN EN 14411.

2. CE marking

With the CE marking, the manufacturer indicates that it assumes responsibility for the conformity of the construction product with the performance stated in the Declaration of Performance as well as compliance with all relevant European legal regulations.

Furthermore, it is responsible for making sure that the CE marking is applied to the actual construction product, to a label or on the packaging. The CE marking is the sole conformity identification for all essential characteristics of a construction product. Additional marks may only be used for aspects which – in our case – are not regulated by DIN EN 14411.

3. Declaration of Performance

As of 1 July 2013, every manufacturer is obliged to establish a Declaration of Performance for each of its construction products. It thereby assumes responsibility for the conformity of the construction product with the declared performance. The Declaration of Performance replaces the former Declaration of Conformity.

The technical documentation of the manufacturer serves as basis for the Declaration of Performance. Among other things, it includes the results of the in-plant production controls such as e.g. initial tests.

The Declaration of Performance has to be provided with an arbitrary reference number by the manufacturer to which the CE marking refers, thus permitting unambiguous identification of the construction product.

The Declaration of Performance can be made available in printed or electronic form (e.g. by e-mail, CD or USB stick).

In addition, the Declarations of Performance for the construction products of Agrob Buchtal GmbH are to be found at www.agrob-buchtal.de/leistungserklaerung. Alternatively, you can scan this QR code:







Albania

Markus Pavelic
Tel.: +49 94 35 3 91-3463
Mobile: +49 171 56 74 713
E-Mail: markus.pavelic@agrob-buchtal.de

Australia

Ceramic Solutions (Aust) Pty Ltd.
Tel.: +61 3 95 45 53 22
E-mail: mail@ceramicsolutions.com.au
Internet: www.ceramicsolutions.com.au

Austria

Robert Wöfler
Tel.: +43 664 1342659
E-Mail: robert.woelfler@agrob-buchtal.de

Bahrain

Patric Kakoschky
Tel.: +49 94 35 3 91-34 47
Mobile: +49 160 7417906
E-mail: patric.kakoschky@agrob-buchtal.de

Baltic States

Nedas Bobinas
Tel.: +370 65 624217
E-mail: buchtal.baltic@gmail.com

Belgium

Philip Daelemans
Mobile: +32 495 30 33 03
E-mail: philip.daelemans@buchtal.be

Bosnia-Herzegovina

Markus Pavelic
Tel.: +49 94 35 3 91-3463
Mobile: +49 171 56 74 713
E-Mail: markus.pavelic@agrob-buchtal.de

Bulgaria

Hristo Shterev
Mobile: +359 886 899 589
E-mail: hshterev@gmail.com

Canada

Eastern Canada
CERAGRES TILE GROUP INC.
E-mail: j.racine@ceragres.ca

Western Canada

V.P. Tile Imports
Tel.: +1 604 240 1760
E-mail: peter@vptile.ca

China

Jeffrey Lung - Agrob Buchtal GmbH
Shanghai Office
Tel.: +86 021 63 81 09 86
E-mail: jeffrey.lung@dsk-asia.com

Jeffrey Lung - Agrob Buchtal GmbH
Beijing Office
Tel.: +86 010 58 69 19 01
E-mail: jeffrey.lung@dsk-asia.com

Croatia

Markus Pavelic
Tel.: +49 94 35 3 91-3463
Mobile: +49 171 56 74 713
E-Mail: markus.pavelic@agrob-buchtal.de

Cyprus

E.K.A. Ltd.
Tel.: +357 2 5 85 44 44
E-mail: mloizides@ekagroup.com

Czech Republic

Ceram Objekt s.r.o.
www.ceramobjekt.cz
Tel.: +420 2 71 74 17 414
E-mail: gciprianova@ceramobjekt.cz

Denmark

Torben Christensen
Tel.: +45 242 05 14 8
E-mail: buchtal@buchtal.dk

Egypt

Patric Kakoschky
Tel.: +49 94 35/3 91-34 47
Mobile: +49 160 7417906
E-mail: patric.kakoschky@agrob-buchtal.de

Finland

ABL Finland OY
Tel.: +358 9 3 50 87 00
E-mail: abl@abl.fi

France

Christophe Rodriguez
Deutsche Steinzeug France S.A.R.L.
Mobile: +33 6 40 94 34 32
E-mail: buchtal@buchtal.fr

Great Britain

Rolf Klebl
Mobile: +49 160 74 28 839
E-mail: rolf.klebl@agrob-buchtal.de

Greece

Emco S.A.
Tel.: +30 210 6 13 83 10
E-mail: jbog@emco.gr

Hungary

Roland Fekete
Tel.: +36 96 51 70 17
E-mail: feketeroland@buchtal.hu

Iceland

Birgisson ehf
Tel.: +354 5160602
E-mail: egill@birgisson.is
Internet: www.birgisson.is

India

Patric Kakoschky
Tel.: +49 94 35 3 91-34 47
Mobile: +49 160 7417906
E-mail: patric.kakoschky@agrob-buchtal.de

Italy

Luigi Maresca
Tel.: +49 94 35 3 91-34 51
E-mail: luigi.maresca@agrob-buchtal.de

Japan

Rolf Klebl
Tel.: +49 94 35 3 91-33 26
Mobile: +49 160 742 88 39
E-mail: rolf.klebl@agrob-buchtal.de

Kosovo

Markus Pavelic
Tel.: +49 94 35 3 91-3463
Mobile: +49 171 56 74 713
E-Mail: markus.pavelic@agrob-buchtal.de

Kuwait

Patric Kakoschky
Tel.: +49 94 35 3 91-34 47
Mobile: +49 160 7417906
E-mail: patric.kakoschky@agrob-buchtal.de

Lebanon

Patric Kakoschky
Tel.: +49 94 35 3 91-34 47
Mobile: +49 160 7417906
E-mail: patric.kakoschky@agrob-buchtal.de

Luxembourg

Philip Daelemans
Mobile: +32 495 30 33 03
E-mail: philip.daelemans@buchtal.be

Macedonia

Markus Pavelic
Tel.: +49 94 35 3 91-3463
Mobile: +49 171 56 74 713
E-Mail: markus.pavelic@agrob-buchtal.de

Moldavia

Sabin Maghiar
Tel.: +40 743 45 29 58
E-mail: sabin.maghiar@deutsche-steinzeug.ro

Montenegro

Markus Pavelic
Tel.: +49 94 35 3 91-3463
Mobile: +49 171 56 74 713
E-Mail: markus.pavelic@agrob-buchtal.de

Namibia

O. Behrens & Co. (PTY) Ltd., Windh.
Tel.: +264 61 23 83 00
E-mail: perstling@obeco.com.na

The Netherlands

Luuk Bovens
Mobile: +31 623 838399
E-mail: luuk.bovens@agrob-buchtal.de

Norway

Stein M. Skogstad
Tel.: +47 66 77 94 98
Mobile: +47 91 39 52 08
E-mail: stein@agrob-buchtal.no

Poland

Rafal Butkiewicz
Tel.: +48 6 01 70 67 57
E-mail: biuro@agrob-buchtal.pl

Portugal

Lusomatec
Tel.: +351 915828266
E-mail: nuno.conceicao@lusomatec.pt
Internet: www.lusomatec.pt

Qatar

Patric Kakoschky
Tel.: +49 94 35 3 91-34 47
Mobile: +49 160 7417906
E-mail: patric.kakoschky@agrob-buchtal.de

Romania

Sabin Maghiar
Tel.: +40 743 45 29 58
E-mail: sabin.maghiar@deutsche-steinzeug.ro

Saudi Arabia

Patric Kakoschky
Tel.: +49 94 35 3 91-34 47
Mobile: +49 160 7417906
E-mail: patric.kakoschky@agrob-buchtal.de

Serbia

Markus Pavelic
Tel.: +49 94 35 3 91-3463
Mobile: +49 171 56 74 713
E-Mail: markus.pavelic@agrob-buchtal.de

Slovakia

BUCHTAL SK, s.r.o.
Tel.: +421 2 44 25 03 69
E-mail: b.hauswald@agrobuchtal.sk
Internet: www.agrobuchtal.sk

Slovenia

Lokar Zastopstva d.o.o.
Tel.: +386 15 61 21 63
E-mail: lokar.zastopstva-ds@siol.net

South Africa (RSA)

Patric Kakoschky
Tel.: +49 94 35 3 91-34 47
Mobile: +49 160 7417906
E-mail: patric.kakoschky@agrob-buchtal.de

Spain

Joaquín Prat Pérez-Nieves
Mobile: +34 607 923 470
E-mail: joaquin.prat@buchtal.es
Internet: www.buchtal.es

Sweden

Stein M. Skogstad
Tel.: +47 66 77 94 98
Mobile: +47 91 39 52 08
E-mail: stein@agrob-buchtal.no

Switzerland

Deutsche Steinzeug Schweiz AG
Tel.: +41 41 6 32 50 60
E-mail: info@deutsche-steinzeug.ch

Turkey

Patric Kakoschky
Tel.: +49 94 35 3 91-34 47
Mobile: +49 160 7417906
E-mail: patric.kakoschky@agrob-buchtal.de

UAE

Patric Kakoschky
Tel.: +49 94 35 3 91-34 47
Mobile: +49 160 7417906
E-mail: patric.kakoschky@agrob-buchtal.de

Ukraine

Markus Pavelic
Tel.: +49 94 35 3 91-3463
Mobile: +49 171 56 74 713
E-Mail: markus.pavelic@agrob-buchtal.de

Sales management**Austria**

Robert Wöfler
Tel.: +43 664 1342659
E-mail: robert.woelfler@agrob-buchtal.de

Belgium, The Netherlands, Luxembourg

Richard van der Maaten
Mobile: +31 (0)621 478134
E-mail: richard.van-der-maaten@agrob-buchtal.de

Eastern Europe without Bulgaria, Poland and Romania

Markus Pavelic
Tel.: +49 94 35 3 91-3463
Mobile: +49 171 56 74 713
E-Mail: markus.pavelic@agrob-buchtal.de

France, Spain, Portugal, Monaco, Andorra

Christophe Rodriguez
Mobile: +33 640 94 34 32
E-mail: christophe.rodriguez@agrob-buchtal.de

Korea, Taiwan, Hong Kong, Thailand, China, Japan, Singapore, Indonesia, The Philippines, Malaysia, Brunei, Vietnam, Myanmar, Laos, Cambodia

Jeffrey Lung
Mobile: +852 51 67 36 66
E-mail: jeffrey.lung@dsk-asia.com

Australia / New Zealand, Bulgaria, Cyprus, Egypt, Greece, India, Iran, Iraq, Libya, Middle East, Namibia, Poland, Romania, Sudan South Africa and Turkey

Patric Kakoschky
Tel.: +49 94 35 3 91-34 47
Mobile: +49 160 741 79 06
E-mail: patric.kakoschky@agrob-buchtal.de

Northern Europe, Baltic States, Canada, Great Britain, Ireland

Rolf Klebl
Tel.: +49 94 35 3 91-33 26
Mobile: +49 160 742 88 39
E-mail: rolf.klebl@agrob-buchtal.de

Italy

Luca Bononcini
Mobile: +39 348 8957344
E-Mail: luca.bononcini@agrob-buchtal.de

Switzerland

Deutsche Steinzeug Schweiz AG
Renato Borsani
Tel.: +41 41 632 50 60
E-mail: renato.borsani@deutsche-steinzeug.ch

USA

DSA Deutsche Steinzeug America, Inc.
Tel.: +1 770 442 55
Fax: +1 770 442 55
Udo Reich
E-mail: udo.reich@agrob-buchtal.com
E-mail: udo.reich@drytilenorthamerica.com
E-mail: info@agrob-buchtal.com
Internet: www.agrob-buchtal.com

Latin America

Diego Chavez
Tel.: +591 76 34 04 22
E-mail: diego@buchtal.latam.com
Internet: www.gcclatinoamerica.com

Project: Bildungspark Schweizerischer Plattenverband / Location: Dagmersellen, Switzerland / Architect: Amberg Architekten AG, Sursee, Switzerland
Series: Craft / Photo: Adriano Faragulo





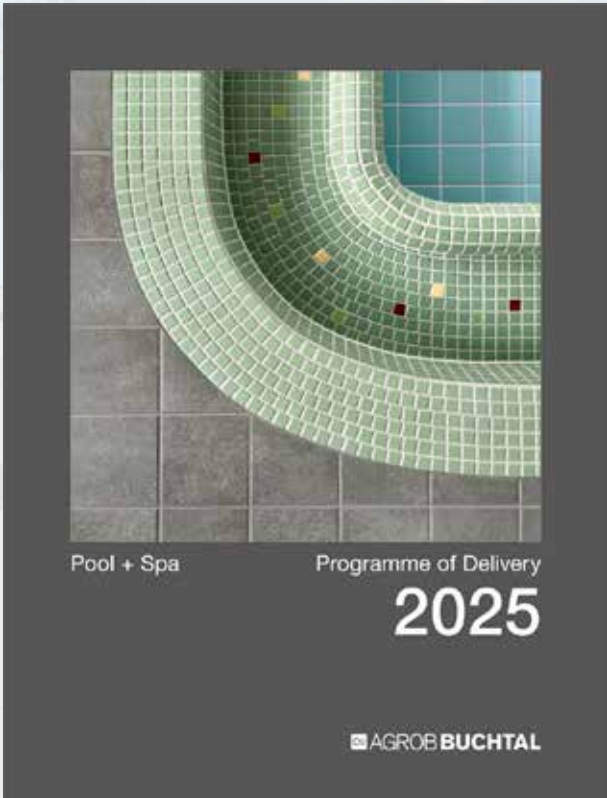
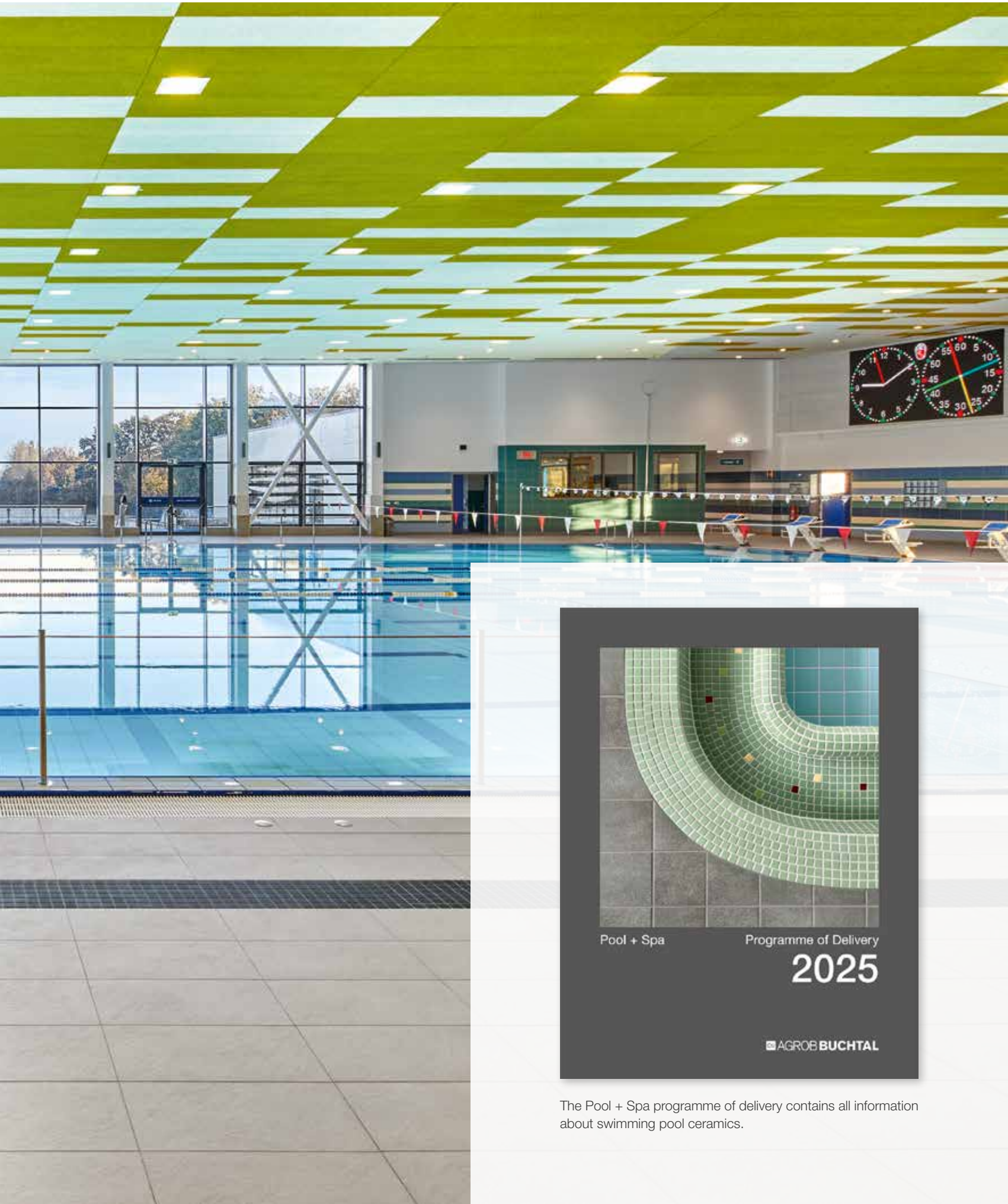

The Pool + Spa programme of delivery contains all information about swimming pool ceramics.

Easy to find

Each individual series is always represented as follows:

- Color chart
- Short description
- Product specifications

- 1 **Series name;** sort of material (see page 521) and relevant product standard (see page 523)
- 2 **Schematic arrangement of the models** from left to right: Standard models from small to large: in the case of extruded split tiles, at first rectangular and then square models from small to large, fittings/special pieces

3 **Peculiarities** of the model

4 **Model number** (only in the case of extruded split tiles)

5 **Nominal dimensions** = work size + recommended joint width in centimetres and inches
Work size = only material dimensions without joint

6 **Surface quality**

7 **Logistic product specifications**

8 **Product standard**

9 **Slip-resistance classification:**
 Barefoot areas/public and industrial areas (see pages 11 and 528 and the following)

10 **Stress groups 1-5;** orientation help for the industrial and commercial sector (see page 524 and the following)

11 **Article number**





12 **Abrasion**
 In the case of glazed materials according to stress groups 1 - 5; (see page 525)

13 **Designation and/or number of color**

14 **Price group** (pricing unit in brackets)

















15 **Color Shade Variation**
 ("Color shade variation" refers to the variations in color between the tiles of a certain color, i.e. the degree of shading. Our products are classified into 4 shading coefficients.)

- V0** No variation / no play of colors
- V1** Low variation / low play of colors
- V2** Medium variation / medium play of colors
- V3** High variation / high play of colors
- V4** Strong variation / strong play of colors

402		Plural non-slip 1		
		stoneware		
		2 Mosaic^{2/4}		
		2,5 x 2,5 cm	5 x 5 cm	10 x 10 cm
				
				
		3 Sheet: 297 x 297 mm Sheet: 297 x 297 mm Sheet: 297 x 297 mm		
5	Nom. dim. - cm/in	2.5 x 2.5 / 1 x 1	5 x 5 / 2 x 2	10 x 10 / 4 x 4
	Work size	23 x 23 x 6.5 mm	47 x 47 x 6.5 mm	97 x 97 x 6.5 mm
6	Surface	smooth, matt	smooth, matt	smooth, matt
	m ² - pieces	11 sheets	11 sheets	11 sheets
	m ² - kg	12.100	12.331	13.101
7	Bundle - pieces	11 sheets	11 sheets	11 sheets
	Bundle - m ²	1.000	1.000	1.000
	Bundle - kg	12.100	12.331	13.101
	Pallet - m ²	48.000	64.000	64.000
	Pallet - kg	580.800	789.184	838.464
8	Product standard	Bib	Bib	Bib
	Slip resistance	R10/B	R10/B	R10/B
10	Stress group	1	1	1
	neutral 10			
13		4 902-2120H	905-2120H	910-2120H
	(active white) 15 	Price gr. A238 (m ²)	Price gr. A205 (m ²)	Price gr. A166 (m ²)

U3 im Umschlag

The following symbols are used:

-  Hytect surface (for description, refer to pages 10 and 527)
-  Protecta surface upgrading (for description, refer to page 527)
-  Novelties
-  no shodfoot traffic
-  Rectified
-  Conically rectified
-  Rectified wall tiles with rounded, bevelled edges
-  Make-to-order production: return and/or cancellation of ordered products not possible
-  Orientation aid for the blind analogue to the requirements of DIN 32984
-  Frost-resistant
-  **R9** Slip-resistant
-  **B** Slip-resistant / Barefoot areas
-  Made in Germany
-  Glued thermoplastically
-  also available in other colors
-  6 mm tile



Management System
ISO 9001:2015



www.tuv.com
ID 9000027001

Agrob Buchtal Solar Ceramics GmbH
Buchtal 1, D-92521 Schwarzenfeld
Tel.: +49 (0) 94 35-391-0
Fax: +49 (0) 94 35-391-34 52

E-Mail: info@agrob-buchtal.de
Internet: www.agrob-buchtal.de

01/2025, www.assenmacher.net

The publisher does not assume liability for misprints.
Color deviations when compared to the original products may occur as a result of printing.

